

This camera manual library is for reference and historical purposes, all rights reserved.

This page is copyright by mike@butkus.org M. Butkus, N.J.

**This page may not be sold or distributed without the expressed
permission of the producer**

I have no connection with any camera company

If you find this manual useful, how about a donation of \$3 to: M. Butkus, 29 Lake Ave., High Bridge, NJ 08829-1701 and send your E-mail address too so I can thank you. Most other places would charge you \$7.50 for a electronic copy or \$18.00 for a hard to read Xerox copy. These donations allow me to continue to buy new manuals and maintain these pages. It'll make you feel better, won't it?

If you use Pay Pal, use the link below. Use the above address for a check, M.O. or cash. Use the E-mail of butkusmi@ptd.net for PayPal.



[back to my "Orphancameras" manuals /flash and light meter site](#)

Only one "donation" needed per manual, not per multiple section of a manual !

The large manuals are split only for easy download size.

EXAKTA

VX 500

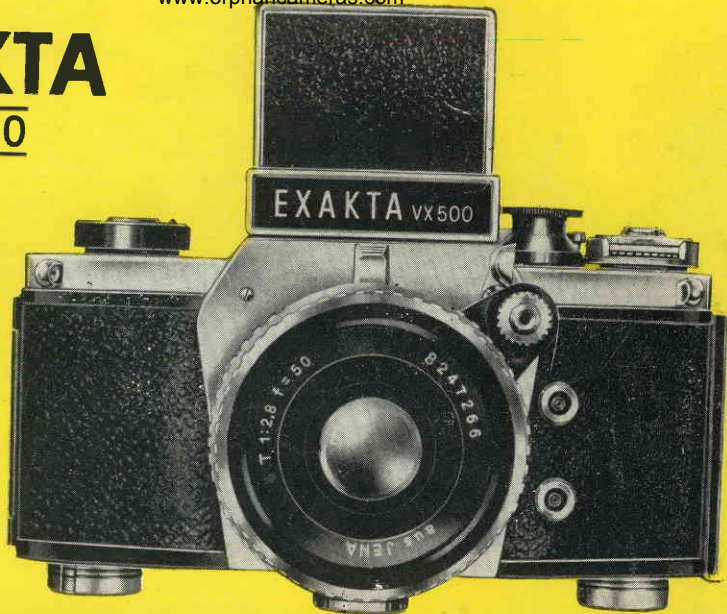

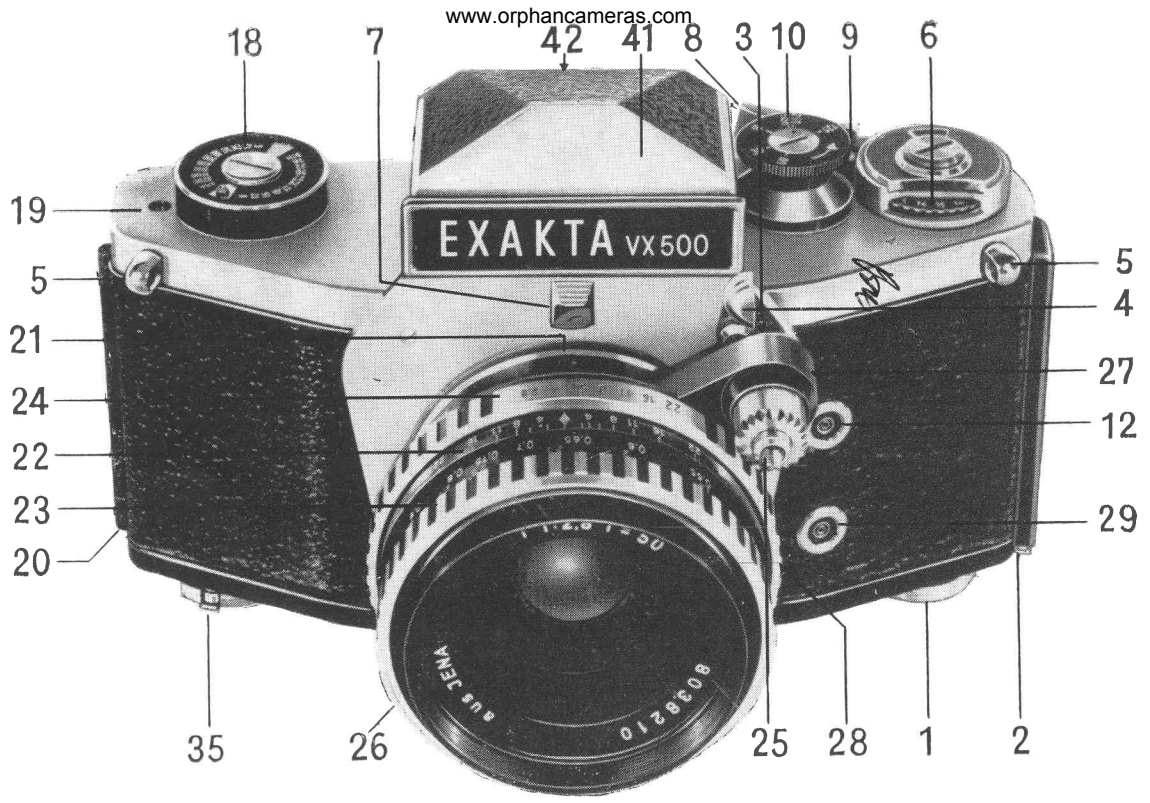

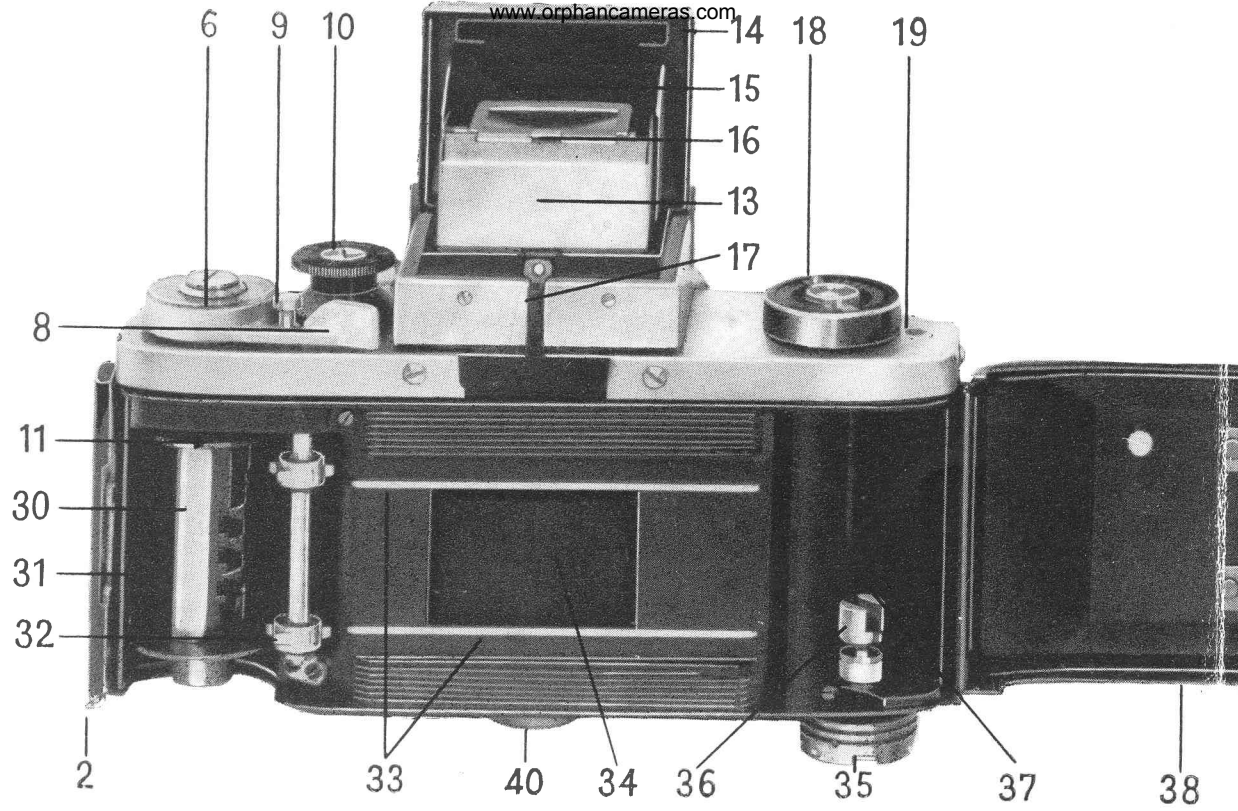

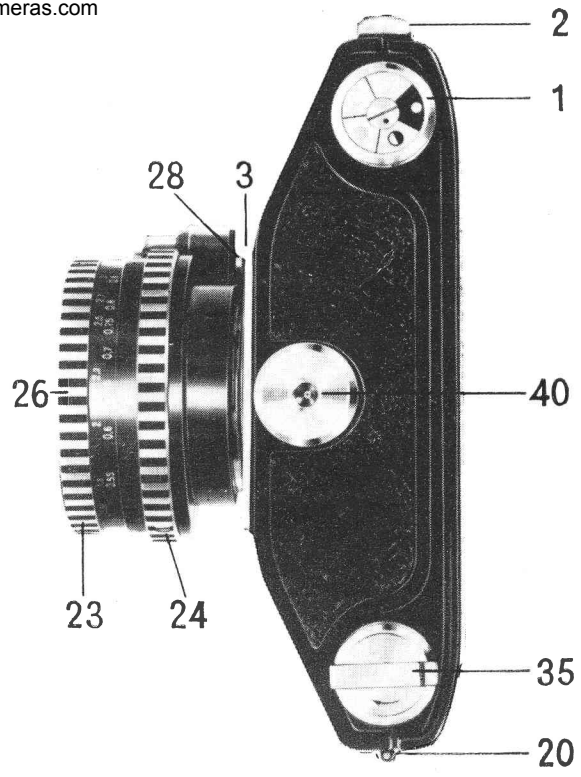
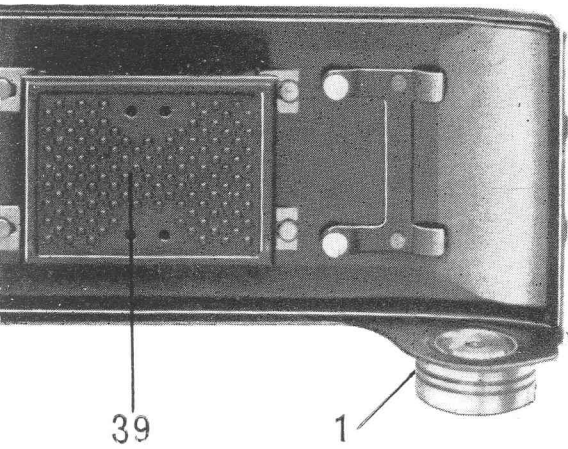

EXAKTA VX 500

We are delighted that you have chosen an EXAKTA VX 500, and we wish you every success with your new camera.

We would like to advise you, however, to read this instruction manual carefully before you start using your camera. In this way you will obtain the greatest possible service from it, since you will eliminate from the outset the possibility of operating it incorrectly, and possibly damaging the

mechanism. The EXAKTA VX 500 is a high-quality precision instrument which can naturally only be expected to answer all your requirements when it is always handled correctly.

Fold out the opposite page to the left to reveal the itemised guide to the camera controls; in this way you can keep constantly referring to this first illustration whilst you are reading the text.

The important operating controls of the EXAKTA VX 500

- 1 = Knob for opening the camera back with film-type reminder disc
- 2 = Camera-back lock
- 3 = Shutter-release knob
- 4 = Pivoted shutter-release lock
- 5 = Eyelets for carrying strap or cord
- 6 = Frame counter
- 7 = Catch for interchanging the focusing systems
- 8 = Rapid-wind lever for tensioning shutter and advancing film
- 9 = Rewind declutching button
- 10 = Shutter-speed setting knob (for speeds from $1/30$ sec. to $1/500$ sec. and B)
- 11 = Friction dog of rapid-wind lever
- 12 = Flash contact X (primarily for electronic flash units)
- 13 = Finder Hood
- 14 = Front of Finder Hood
- 15 = Swing-up focusing magnifier
- 16 = Handle for swinging the focusing magnifier
- 17 = Lever for opening the Finder Hood
- 18 = Film-sensitivity reminder disc
- 19 = Indicator disc for checking film advance
- 20 = Camera-back hinge
- 21 = Red aligning dot on camera (for changing lenses)
- 22 = Depth-of-field scale or automatic depth-of-field indicator
- 23 = Distance-setting (focusing) ring
- 24 = Aperture-setting ring
- 25 = Release mechanism for lenses with fully automatic aperture (release knob or release rocker)
- 26 = Lens

- 27 = Red aligning dot on lens
(for lens changing)
- 28 = Lens locking lever
- 29 = Flash contact F (for flashbulbs)
- 30 = Take-up spool with blue pin
- 31 = Chamber for take-up spool or
cassette
- 32 = Film-wind sprocket
- 33 = Film-guide runners
- 34 = Film gate with blind of focale-plane
shutter
- 35 = Rewind crank
- 36 = Dog of rewind crank
- 37 = Chamber of cassette containing
unexposed film
- 38 = Non-detachable hinged camera back
- 39 = Exchangeable film-pressure plate
- 40 = Tripod bush
- 41 = Penta Prism
- 42 = Eyepiece of Penta Prism

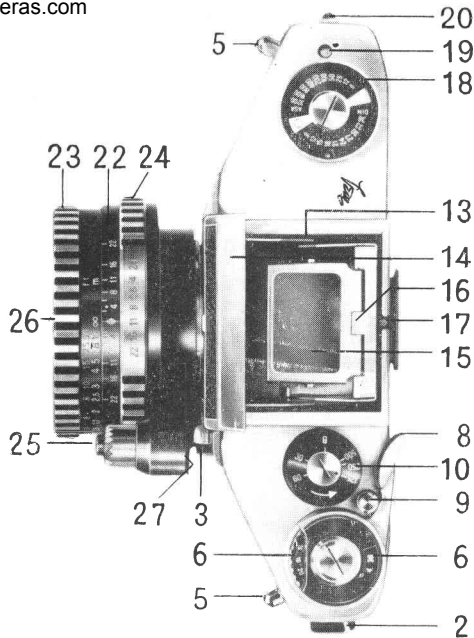

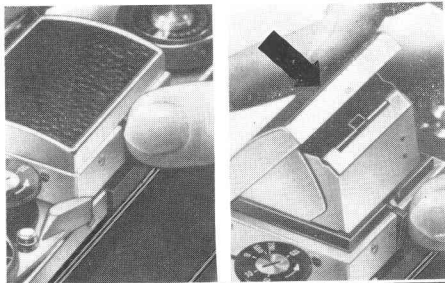

Preparations for use

The Finder Hood (13) is opened by pressing on the lever (17). To close the hood, press the front (14) backwards until it locks. The focusing magnifier (15) can be swung into either the working or rest positions by means of handle (16). For further information on the use of the Finder Hood see page 26.

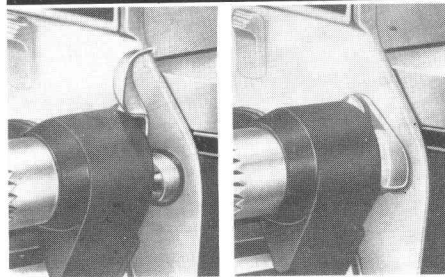

Swing the shutter-release lock (4) out of the way; then release the shutter either by pressing directly on the shutter-release knob (3) or indirectly by depressing the release knob or rocker arm (25) on the lens. When you have finished taking pictures, swing the shutter-release lock (4) so that it covers the shutter-release knob (3), making shutter release impossible, thus avoiding unintentional exposures.

Film loading

Loading and changing the film must not take place in direct sunlight! The EXAKTA VX 500 uses standard 35 mm miniature film, in cassettes of 20 or 36 exposures to make negatives 24 mm \times 36 mm. Perfect film transport requires faultless film cassettes. Daylight loading spools should only be inserted in cassettes made by the same manufacturers.

1. Depress camera-back lock (2) downwards. Open hinged camera back (38).

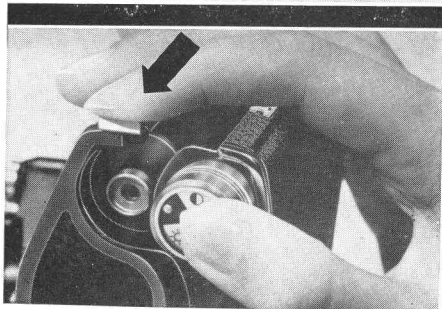
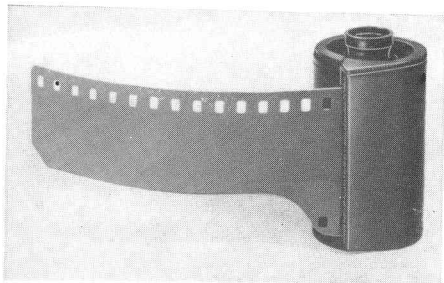

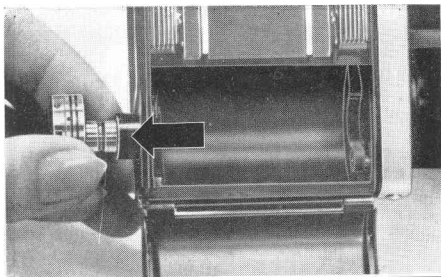

2. Pull out the rewind crank (35) by means of its knob.

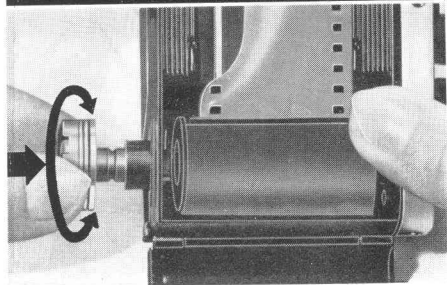

3. Insert the cassette containing the unexposed film in the feed chamber (37). Push the knob of the rewind crank (35) back into the camera body, twisting the knob gently in either direction to engage the dog (36) with the bar in the cassette core.

4. Remove the take-up spool (30) from the chamber (31). Push the beginning of the film under the clamping spring of the take-up spool and wrap one half turn round the core of the spool.

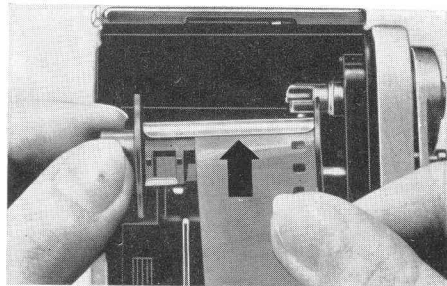

5. Replace the take-up spool (30) in the film chamber (31) and turn it slightly in the wind-on direction so that the friction dog (11) of the rapid-wind lever (8) couples with the bar inside the spool core and allows the spool to be pushed right home into the chamber (31).

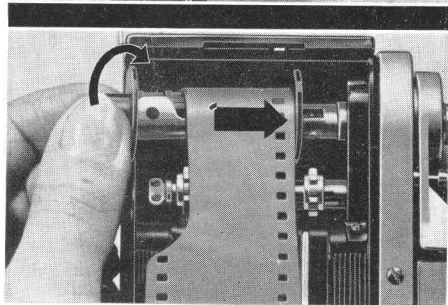

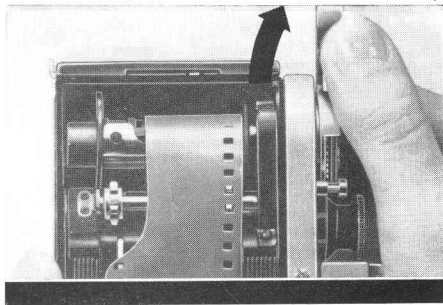

6. Swing the rapid-wind lever (8) right up to its stop (if necessary first releasing the shutter). These two processes may have to be repeated until the teeth of the film-wind sprocket (32) engage with the perforation holes on both sides of the film.

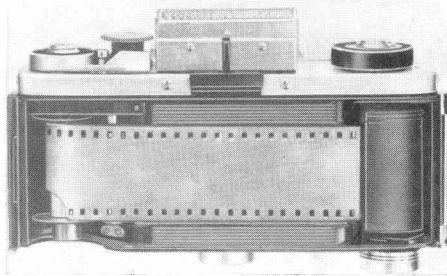

7. The correctly inserted film runs from the full cassette as tightly as possible over the film-guide runners (33) in the somewhat deeper lying film track and over the film-wind sprocket (32) on to the take-up spool (30).

8. Closing the camera: Close the camera back (38) and press it lightly home until an audible click of the camera-back lock (2) is heard. In closing the camera, insert the borders of the camera back precisely in the grooves of the camera body.

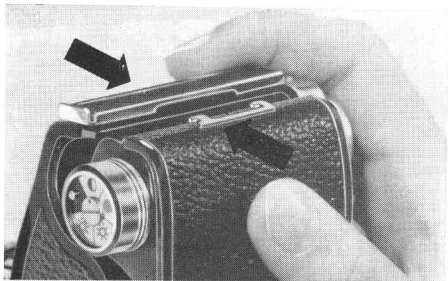

2x

9. Expose two blank frames to wind on the fogged leader-length at the beginning of the film: release and swing the rapid-wind lever (8) as far as it will go. Once again: release and swing the rapid-wind lever (8) as far as it will go.

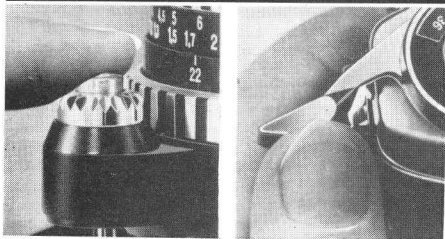

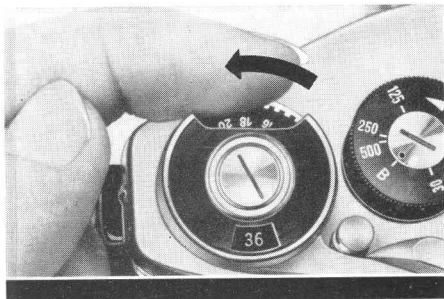

10. Setting frame counter (6). Turn the disc of the frame counter (6) with the index finger to the left (anticlockwise), until, when using a film with 36 exposures the figure "36", or when using a film with 20 exposures the figure "20" appears in the centre of the window.

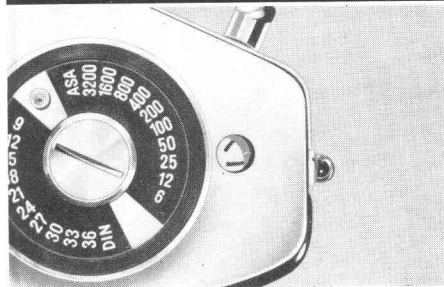

The EXAKTA VX 500 is now ready for action, and the frame counter will indicate after each exposure the number of unexposed frames still left on the film in the camera. To check the film transport observe indicator disc (19): the disc with its red mark rotates, when the spool of the film-feeding cassette is revolving.

11. When film is loaded, immediately set the film-type reminder disc in the back-opening knob (1) and the film-sensitivity reminder disc (18) as a reminder of the type of film that is in the camera. Both discs may be turned in either direction, until the appropriate reference is opposite the red dot, or, in case of the film-sensitivity disc, opposite the black triangle. The film-type symbols have the following meaning:

- = black-and-white film
- = red dot = universal colour film for daylight and artificial light
- ☀ = colour film for daylight
- ☀ = colour film for artificial light

Example above: setting for colour film in daylight

Example below: film sensitivity 18 DIN

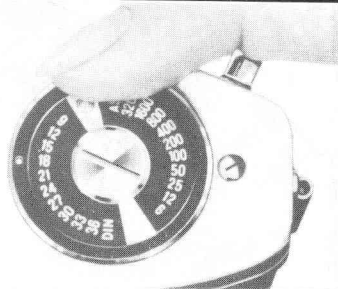
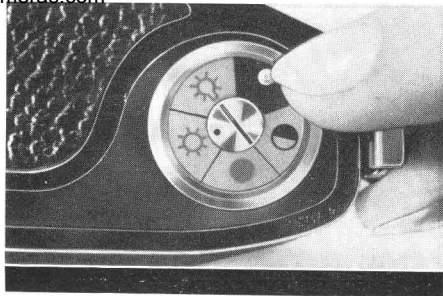

Using a take-up cassette

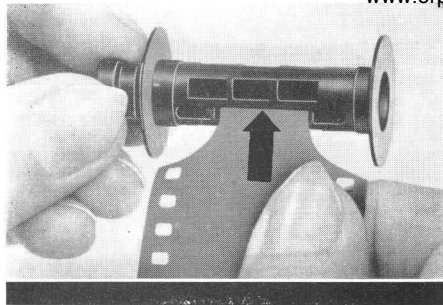

In place of the take-up spool (30), an empty standard-type film cassette (if possible made of metal) may be placed in the take-up chamber (31).

Take care to check the condition of this take-up cassette thoroughly: the core should move easily within the shell of the cassette and must not jam (if necessary the friction points of the cassette core may be lubricated by rubbing them with paraffin wax). — When using a take-up cassette proceed as follows: attach the leader tongue of the film to the core of the cassette spool, ensuring that the bar in the core of the spool is on the right as the spool is turned away from the body, and insert the cassette so that the friction dog (11) of the rapid-wind lever (8) engages with the bar in the core of the spool. Then check that the film is pulled taut between the two cassettes, and is lying correctly between the guides, against the register rails in the deeper channel.

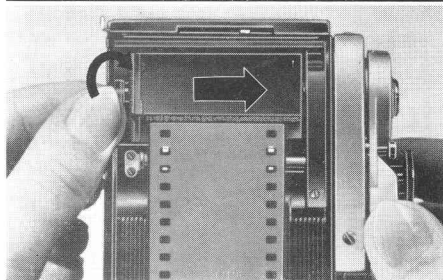

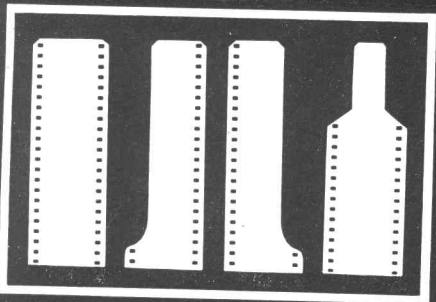
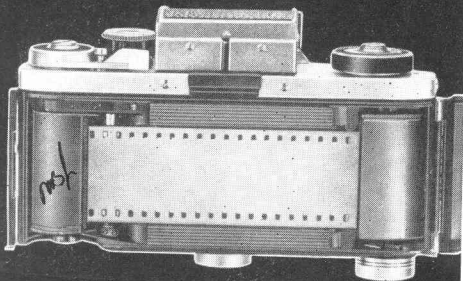

When using a take-up spool it is not necessary to trim the beginning of the film specially. Any shape of leader can be used with the take-up spool of the EXAKTA VX 500, either the narrow tongue provided on standard commercial cassettes, or, even better, a straight cut-across end (such as obtained when cutting lengths of film from bulk rolls).

When employing a take-up cassette the film must be trimmed to suit the core of the cassette spool.

For changing film, refer to page 33.

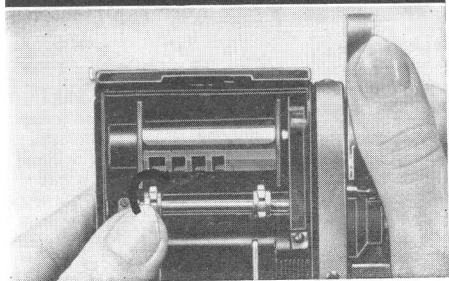
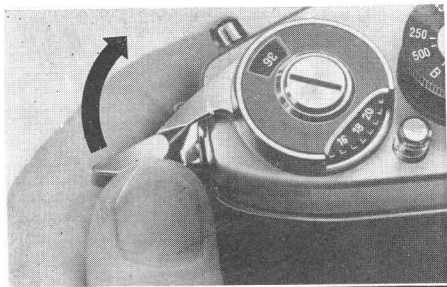

Operating the shutter

1. The shutter is tensioned and the film wound on by operating the rapid-wind lever (8). This lever should always be swung right up to its stop, and will then spring back of its own accord (the fast returning lever should be restrained gently with the thumb).

The tensioning of the shutter and the transportation of the film are coupled (avoiding unintentional double exposures and blank frames). It is impossible to release the shutter before it has been fully tensioned and the film wound on. Never force the rapid-wind lever back from any intermediate point in its travel.

Should the rapid-wind lever (8) not spring back automatically when the camera is empty, the back (38) should be opened and the film-wind sprocket (32) turned a little towards the exposed-film chamber (31). The rapid-wind lever (8) should be gently nudged during this operation.

2. The reflex image in the viewfinder (Finder Hood, Penta Prism or Lens Magnifier) will be visible even after the shutter has run down (Instant return mirror). The red warning signal in the reflex image indicates that the camera is not yet ready for action, and that the rapid-wind lever (8) must be cocked before the shutter is ready for release (see illustration: reflex image seen through Penta Prism).

3. Setting of shutter speeds

Shutter speeds from $1/500$ sec. to $1/30$ sec. can safely be employed "by hand", i. e. without the use of a tripod. For any longer exposure times, including delayed action exposure (shutter setting B), the camera should be firmly supported (on a table, against a wall etc.) or a tripod should be employed. The tripod socket (40) is situated underneath the EXAKTA VX 500.

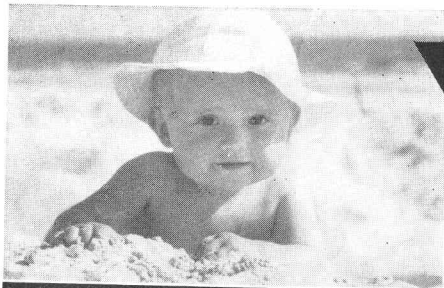

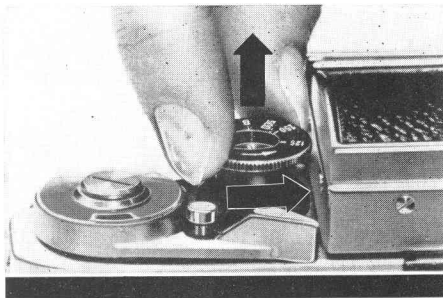

Selection of exposure times from $\frac{1}{500}$ sec. to $\frac{1}{30}$ sec. and shutter setting B for exposure times of any length desired

Before or after tensioning the shutter lift the small shutter-speed setting knob (10), turn it in the direction of the arrow until the desired speed value or the letter B is opposite the setting dot on the central disc, and then allow the knob (10) to spring back.

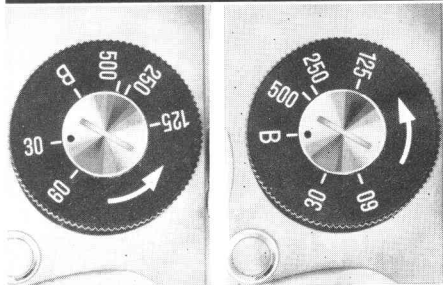

The figures represent fractions of seconds: for example $30 = \frac{1}{30}$ sec., $125 = \frac{1}{125}$ sec. Intermediate speed values cannot be set. In case of the B setting the shutter will remain open so long as pressure is maintained upon the shutter-release knob (3) or on the release mechanism of the lens (25). The B setting is very important above all for taking night and indoor exposures.

Cable releases with long plunger and time-exposure lock may be screwed into the shutter-release knob (3) on the camera or into the release mechanism (25) on the lens. Very important for the B setting of the shutter: After pressing on the cable release, operate the time-exposure lock. In this way the shutter will remain open without having to keep one's finger constantly on the release until the time-exposure lock is disengaged (also eliminating camera shake).

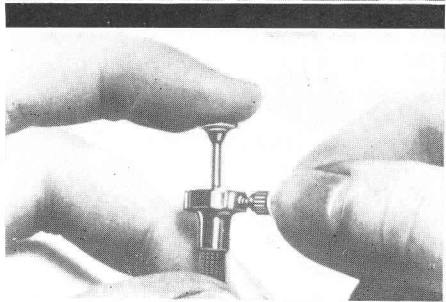
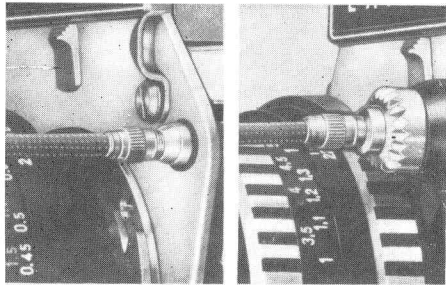

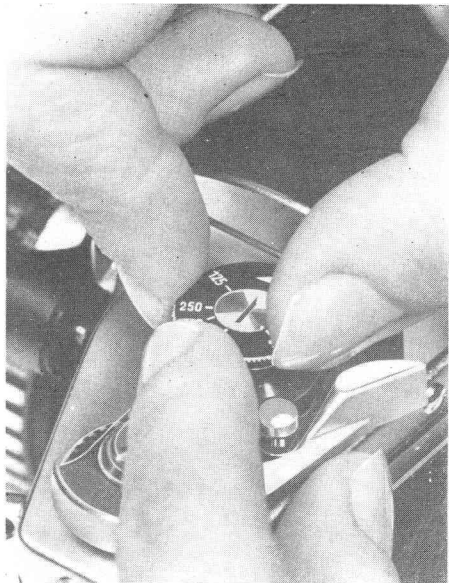

Intentional double exposures

With the EXAKTA VX 500, it is not possible for unintentional double exposures to occur. It is, however, possible to take double exposures on purpose (e.g. for trick photography). After the first exposure, the shutter can be re-tensioned without winding on the film as follows: turn the small shutter-speed setting knob (10) as far as it will travel in the direction of the arrow, without lifting it; the knob should be held to prevent it from springing back.

Operating the lens

1. The aperture value (f/No) is selected by means of the aperture-setting ring (24). Turn this ring until the desired f/No on the aperture scale is opposite the mark. For instructions on operating the diaphragm mechanism, see the sections dealing with the various lenses on page 22 onwards.

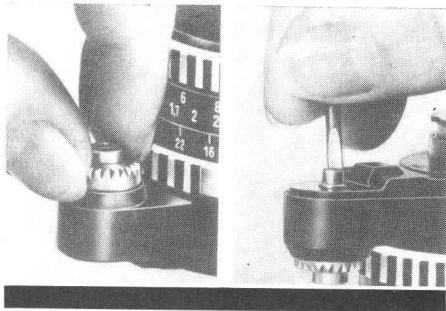

matically. By letting go of the release knob (25) the diaphragm reopens automatically. To check the depth of field whilst focusing, depress the lens-release knob (25) just far enough to stop down the lens as required without releasing the shutter. In order to ensure that the shutter release knob (3) on the camera body is always depressed far enough to trigger the shutter the setscrew on the release mechanism of the lens should be adjusted to the required length with a screwdriver. — A cable release with a long plunger can be screwed into the lens-release knob (25).

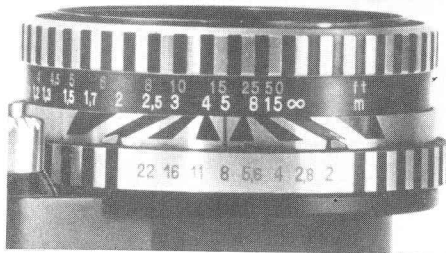

Automatic depth-of-field indicator on the Pancolar 2/50 lens: After setting the aperture and distance, follow the appropriate black/white bands from the two black markers to the distance scale, upon which the depth-of-field range can be read off. Example: aperture setting f8, distance 5 metres (17 ft) = depth of field from barely 3 metres (10 ft) to over 15 metres (actually 23 metres or 76 feet).

Fully-automatic pressure diaphragm on Domiplan 2.8/50 lens

Diaphragm always fully opened for focusing. Pre-select the required aperture (f/No) by turning the aperture-setting ring (24); intermediate settings can be selected. By depressing the release rocker (25), the lens will stop down automatically; when the pressure on the rocker is relaxed, the diaphragm re-opens automatically. To check the depth of field the release rocker (25) may be depressed part way so that the diaphragm closes down without releasing the shutter. To disengage the automatic diaphragm mechanism, screw into the release rocker (25) the locking knob which can be delivered as an accessory part.

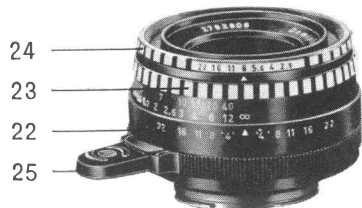

24

Focusing for infra-red pictures

When using infra-red film, first focus the reflex image normally, then note the distance indicated by the red setting mark (either in feet or in metres, or the infinity symbol), and turn the focusing ring to set this distance against the red dot (the infra-red setting mark) which is either to the right or to the left of the normal setting mark. By doing this the image produced by the invisible infrared rays, which lies at a greater distance from the lens than the image formed by visible light, will be brought into sharp focus in the film plane of the camera and consequently will appear sharp in the negative.

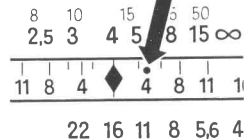
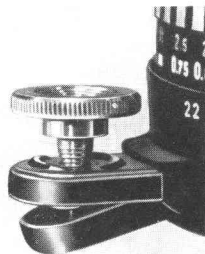

22 16 11 8 5,6 4



3. Changing the lens (26) (select automatic on all lenses from Jena): depress the locking lever (28) towards the lens, then turn the lens towards the left until the two red dots (21 and 27) are in line, and lift the lens out towards the front.— To insert a lens proceed in the reverse sequence: line up the red dots, and turn the lens towards the right until it locks.— All special-purpose lenses can be used, with focal lengths ranging from the shortest to the longest.

Special-purpose lenses for the EXAKTA VX 500

| Designation, speed and focal length in mm | Type of aperture*) | Angle of view (horizontal) | Front mount for screw-in and push-on accessories |
|--------------------------------------------|--------------------|----------------------------|--------------------------------------------------|
| Flektogon 4/20 | FSD | 93° | M 77 × 0.75,80 mm ∅ |
| Lydith 3.5/30 | PSD | 71° | M 49 × 0.75,51 mm ∅ |
| Flektogon 2.8/35**) | FSD | 62° | M 49 × 0.75,51 mm ∅ |
| Biotar 1.5/75 | PSD | 32° | M 58 × 0.75,60 mm ∅ |
| Orestor 2.8/100 | CSD | 25° | M 49 × 0.75,51 mm ∅ |
| Orestor 2.8/135 | PSD | 18° | M 55 × 0.75,57 mm ∅ |
| from Jena S 4/135**) | FSD | 18,5° | M 49 × 0.75,51 mm ∅ |
| from Jena S 2.8/180 | FSD | 14° | M 86 × 1 90 mm ∅ |
| Orestegor 4/200 | PSD | 12° | M 58 × 0.75,60 mm ∅ |
| Orestegor 4/300 | PSD | 8° | M 95 × 1 100 mm ∅ |
| from Jena S 4/300 | FSD | 8° | M 86 × 1 90 mm ∅ |
| Orestegor 5.6/500 | PSD | 5° | M 118 × 1 125 mm ∅ |
| from Jena Catoptric (mirror) lens 4/500 | no diaphragm | 5° | built-in filter turret |
| from Jena Catoptric (mirror) lens 5.6/1000 | no diaphragm | 2.5° | built-in filter turret |

*) CSD = Click-Stop-Diaphragm
 PSD = Pre-set diaphragm
 FSD = Fully-automatic spring diaphragm

***) with extra-long helical thread for close-up focusing without special accessories, with Flektogon 2.8/35 down to $6\frac{3}{4}$ inches, and with S 4/135 from Jena down to 40 inches.

Using the Finder Hood

The reflex image in the Finder Hood (13) of the EXAKTA VX 500 may be used both for selecting or framing the subject, and also for focusing and checking the depth of field by provisionally stopping down the lens. Generally, a large enough image for normal viewfinding purposes will be obtained when using the standard ground-glass screen or the Fresnel screen; for critical focusing, however, we recommend the additional use of the Focusing Magnifier: The pivoted Focusing Magnifier (15) will swing into its working position when the Finder Hood is opened, but can be folded back out of the way by operating the handle (16); see also page 4. Refer to page 30 for instructions on the use of the Fresnel screen.

Normally, the EXAKTA VX 500 is held at chest or shoulder level. When the supple-

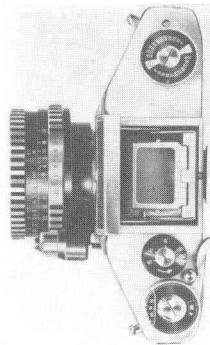

mentary focusing screen (15) or, respectively, the Fresnel screen and the pivoted Focusing Magnifier (15) are used in addition to the ground-glass screen, the camera must be held close to the eye. When taking vertical pictures with the Finder Hood it is possible to shoot at right angles. This is particularly useful for working incon-

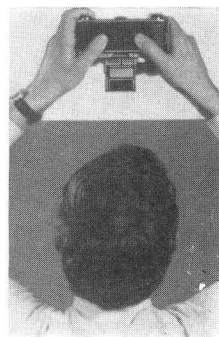

spicuously since the photographer can remain in concealment.

(The Penta Prism makes it possible to take vertical pictures with a direct line of vision and also provides a laterally-correct and upright viewfinder image).

The image on the ground-glass screen of the Finder Hood (13) can also be observed

from below when the camera is held above the head. This will prove very useful when taking pictures over walls or over the heads of crowds.

Users who normally wear spectacles should use their close-up (reading) glasses for focusing with the Finder Hood. For interchanging the Finder Hood, see page 31.

Using the Penta Prism

The Penta Prism serves the same purpose as the Finder Hood, with the exception, that the reflex image on the ground-glass screen will invariably be upright and laterally-correct no matter whether the camera is held horizontally or vertically; this is particularly useful when taking pictures of moving subjects, since the image in the viewfinder will move in the same direction as the subject itself. With very rapidly-moving subjects the camera can thus be "panned" by swinging it gently in the direction of motion of the subject (as for example, with racing cars). When employing the Penta Prism (41) the camera should always be held at eye level. Viewing the reflex image through the eyepiece (42) may be effected with either eye. For normal upright and horizontal exposures the EXAKTA VX 500 should be held with the right hand and focused with the



right-hand thumb and index finger. The left hand should give additional support, the left-hand index finger being used for releasing the shutter. The reverse handling is possible for horizontal exposures: to prevent camera shake when using the EXAKTA VX 500, press the back of the camera against the forehead.

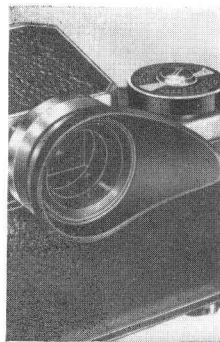
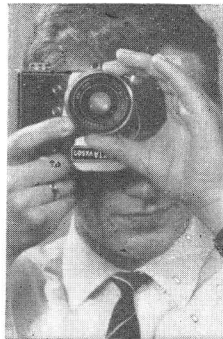
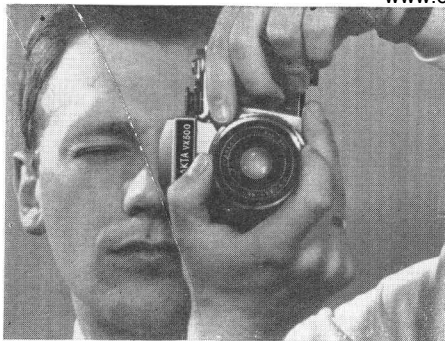

Photographers who normally wear spectacles should use their distance glasses for focusing with the Penta Prism. Refer to page 30 for instructions on the use of the Fresnel screen. — For fitting and removing the Penta Prism see page 31.

An invaluable accessory for use with the

Penta Prism is the flexible eyepiece cup: this is fitted on to the eyepiece (42) of the Penta Prism and shields it from distracting straylight. It is also helpful for spectacle-wearers since vision-correction lenses made by one's optician can be inserted into the revolving mount, making it possible to focus without wearing glasses.

Focusing with the Fresnel screen

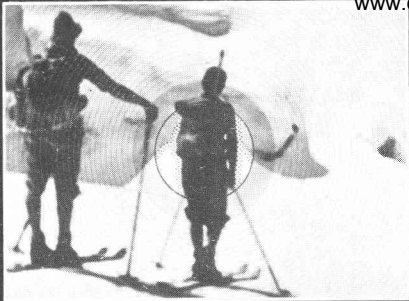

The EXAKTA VX 500 may optionally be supplied with a Fresnel screen. With this screen, focusing is mainly performed using the centrally placed matt ring without the fresnel line structure. To increase the accuracy of focusing, a micropism is centered in this ring. The extra brilliant image visible in this patterned field serves for focusing in much the same way as the image on the ground-glass screen, except that with the micropism, incorrect focusing will result in an image which is blurred to a greater degree. The lens will be correctly focused when the image in the micropism is at its sharpest. It is, however, absolutely essential to focus with a large aperture (small aperture number), as with apertures of $f5.6$ and smaller, the image in the micropism field will appear relatively sharp, even with the lens incorrectly focused. This, of course, will lead to unsatisfactory results. For extreme close-ups of

magnifications greater than 1:1, and photomicrography, the microprism cannot be used.

Interchanging of the focusing systems

The focusing systems of the EXAKTA VX 500 (Finder Hood, Penta Prism, Lens Magnifier, see back cover of this instruction manual) are interchangeable. The Finder Hood (13) must be closed when the Finder Hood insert is being removed from the camera. When any of the viewfinder inserts are being removed from the camera, the viewfinder-retaining catch (7) must be pressed downwards, and the Finder Hood, Penta Prism or Lens Magnifier withdrawn upwards without tilting. On replacing a viewfinder unit, it must be inserted squarely and vertically, and be pressed downwards until it clicks into position. Never use force!

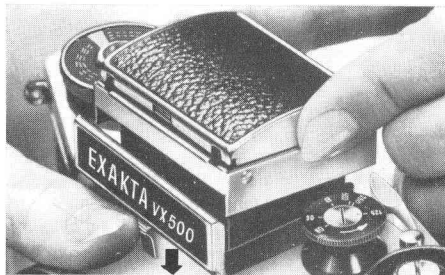

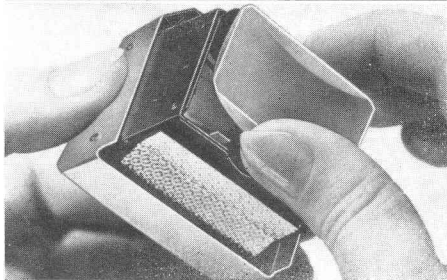
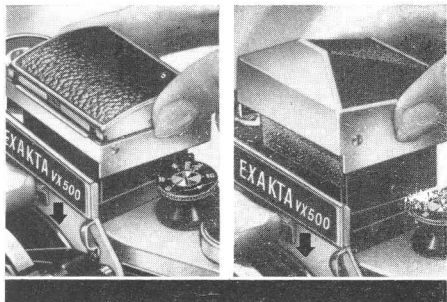

Exchanging the focusing screen or Fresnel screen

The focusing screen or the Fresnel screen of the viewfinder systems of the EXAKTA VX 500 are interchangeable, so that, if desired, the ground-glass screen, the Fresnel screen, the ground-glass screen with field framing, one of the special focusing screens or the flat ground-glass screen (for further particulars see back cover of this instruction manual) may be used. When fitting or removing a focusing screen or Fresnel screen from the Finder Hood insert, the Finder Hood (13) must be closed.

Remove the viewfinder insert as described on page 31. The focusing screen or Fresnel screen should be gripped by the long sides, and withdrawn from the viewfinder. — To refit the focusing screen, Fresnel screen or flat ground-glass screen it should again be held by the long sides and pushed in between the securing springs of the view-

finder system. Never touch the matt surface of any screen. (With the Finder Hood insert, the Finder Hood must first be closed).

Changing the film

If the frame counter (6) has been correctly set when loading the film, then after the 20th or 36th exposure, the number 36 will appear in the centre of the frame-counter window. It may be possible to expose one or two further frames before the film can no longer be transported.

Should the rapid-wind lever (8) stop before reaching the end of its forward travel during the last film transport, then depress the rewind-release button (9), at the same time cocking the rapid-wind lever (8) fully. It should now return to its rest position. When using a take-up spool (30), the film should now be rewound back into its cassette.

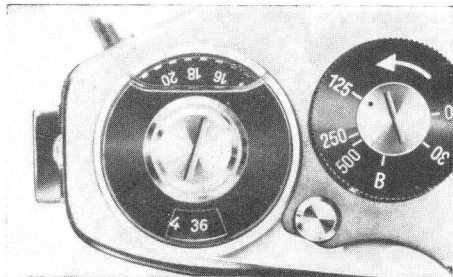

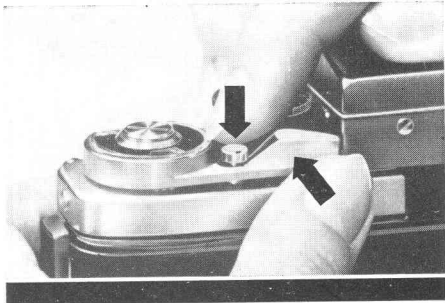

1. Depress the rewind button (9) and secure the rapid-wind lever (8) with a light pressure in the slot of the rewind button, so that it stays in the rewinding position. (The next time that the rapid-wind lever (8) is wound, the rewind button (9) will spring back into its normal position, and the camera will then again be ready for forward transportation of the film.)

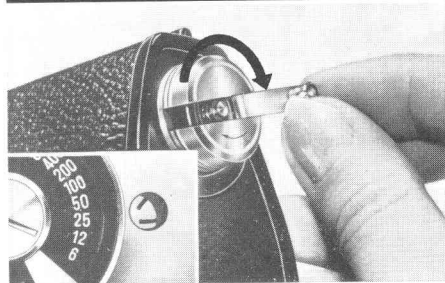

2. Hold the camera in the left hand. Swing out the rewinding crank (35), and with the right hand turn it evenly and slowly in the clockwise direction, until it is felt that it turns more easily. The film has now been rewound. (If the film is rewound at too great a speed, static electricity will cause discharge marks to appear on the negatives.) If the film is being correctly rewound, the indicator disc (19) will show this by revolving also.

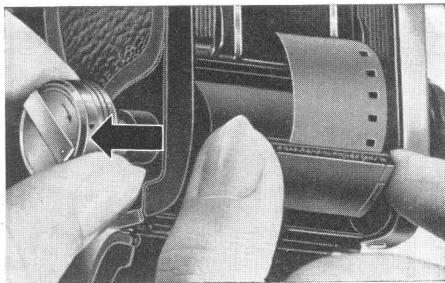

3. Open the camera back. Withdraw the rewind crank (35) by means of its knob, and remove the cassette of exposed film from the camera. Depress the knob on the rewind crank (35) to push it back into the camera.

When using a take-up cassette, expose one more frame after the 36th exposure, taking care not to photograph anything of importance on it. Then operate the rapid-wind lever (8) to wind the 36th frame right inside the cassette. Open the back and cut or tear off the film. Take the full take-up cassette out of the take-up chamber (31) and wind the end of the film right inside the cassette.

Flash Photography

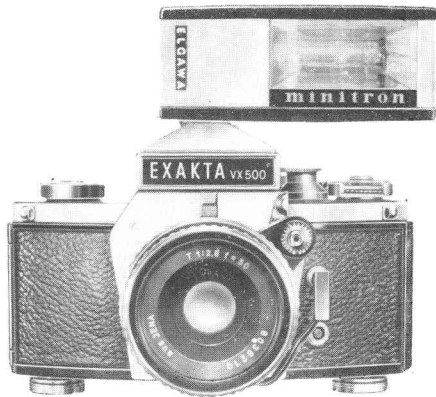

The EXAKTA VX 500 has two connections for flash synchronizing: Outlet X (12) for open flash technique with electronic flash units and flashbulbs. Outlet F 29 for the use of fast-burning flashbulbs. The synchronizing cord of standard or electronic flashguns usually available in trade should be connected to the appropriate socket on the camera according to the following instructions. The shutter must always be tensioned before connecting a flashgun. Should a flashbulb fail to fire, e.g through poor contact in the circuit, then the bulb has to be removed after the shutter has run down. However, do not insert a new bulb until the shutter has been re-tensioned!

Use of electronic flash units (open flash technique)

The synchronizing cord should be connected to the X contact (12) and the shutter set to $1/60$ sec. or to $1/30$ sec. When using electronic flashguns without storage condensers, designed for mains operation only, the shutter must be set to B. The effective exposure time, however, is the duration of the flash, and not the time that the shutter remains open.

After the flash has lighted up, close the shutter immediately in order to avoid secondary exposures.

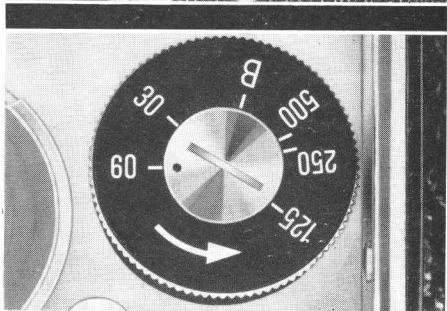
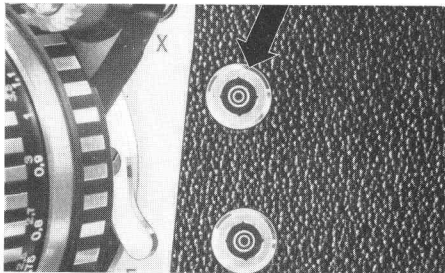

The smaller aperture numbers, e. g. f2, 2.8, 4, indicate relatively large diaphragm openings: these permit brief exposures, but give only shallow depth of field. The larger aperture numbers, e. g. 16, 22, indicate relatively small diaphragm openings requiring longer exposure times, but giving great depth of field. Further information on the depth of field will be found on page 21.

2. The lens is focused by turning the distance-setting ring (23) and observing the definition of the reflex image in the viewfinder. The lower values on the distance scale indicate metres, whilst the larger values above them represent feet. All distances are measured from the back of the camera to the subject. When the image of the subject in the reflex view-

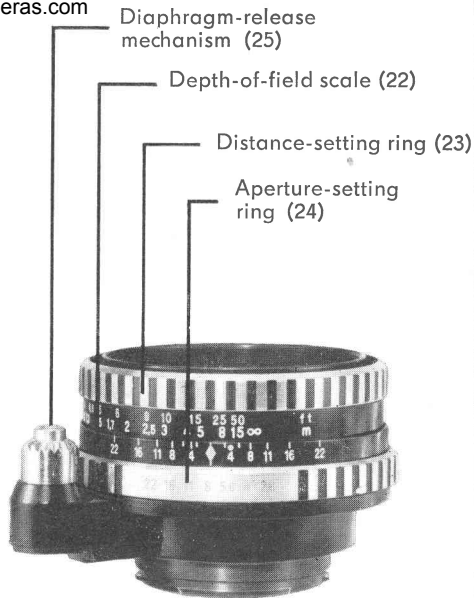

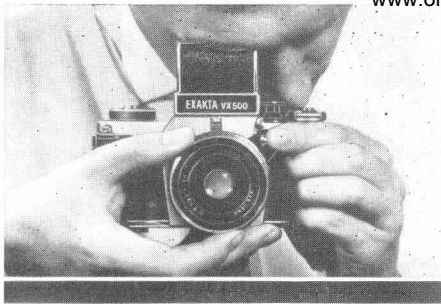

finder attains its sharpest definition, then the correct camera-subject distance in feet or metres will be in line with the red setting mark. For further information on using the fresnel lens (with microprism field) see page 30.

When focusing the reflex image use the maximum aperture of the lens, i. e. the smallest f/No, to obtain the most brilliant image, and then stop down just before the exposure. It is not necessary to take the camera from your eye, since all the lenses are equipped with fully-automatic spring or pressure diaphragms. For more detailed information see the descriptions of the lenses on page 22 onwards.

Reading off the depth of field

When the depth of field is great, objects at widely varying distances from the camera will form a sharp image. The precise extent of this sharp zone will be indicated

(after focusing) by the depth-of-field scale (22) on the lens: on either side of the red distance-setting mark you can read off from the distance scale where the depth-of-field zone begins and ends for any specific aperture setting. If the relevant f/No. on one side of the central distance-setting mark is in line with the infinity symbol (∞), or even beyond it, then the depth of field will extend right up to infinity. On the right there are two examples and a photograph demonstrating large depth of field.

Above: Distance setting 2 metres ($6\frac{1}{2}$ ft), aperture f 5.6 = depth of field extends from 1.70 m ($5\frac{1}{2}$ ft) to 2.50 m ($8\frac{1}{2}$ ft).

Below: Distance setting 4 metres (13 ft) aperture f 16 = depth of field extends from 2 metres ($6\frac{1}{2}$ ft) to infinity (∞)

The Pancolar 2/50 mm lens from Jena has an automatic depth-of-field indicator; see page 23.

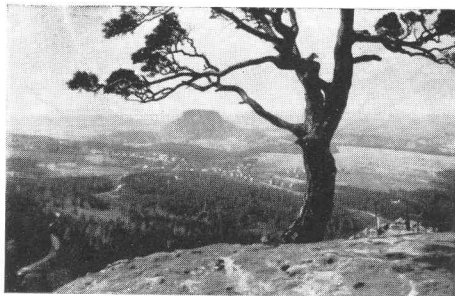
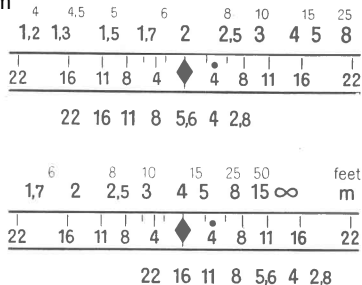

Fully automatic spring diaphragm on the lenses T 2.8/50 from Jena and Pancolar 2/50 from Jena

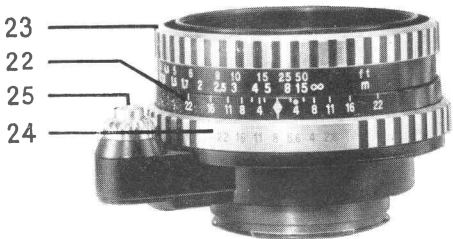

Automatic diaphragm mechanism disengaged

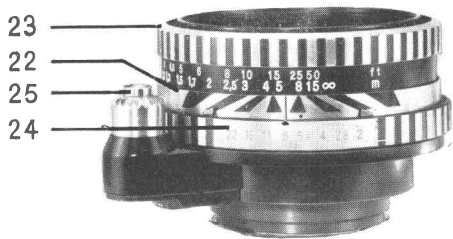

Automatic diaphragm mechanism engaged

Engage the automatic diaphragm mechanism by pushing the release knob (25) on the lens towards the camera together with its mount and turn it to the right (viewed from the front of the camera). – To disengage the automatic diaphragm, press the release knob (25) together with its mount towards the camera and turn it to the left (again looking from the front). When the automatic mechanism is disengaged (= normal diaphragm), the diaphragm will remain stopped down to the selected f/No (this is important for close-up photography without the use of an auto-couple extension release). – When the automatic mechanism is engaged, the diaphragm will be fully opened for focusing. Select the required smaller aperture (larger f/No) by turning the aperture setting ring (24), which can also be set to intermediate stops. By depressing the lens-release knob (25) the diaphragm is stopped down auto-

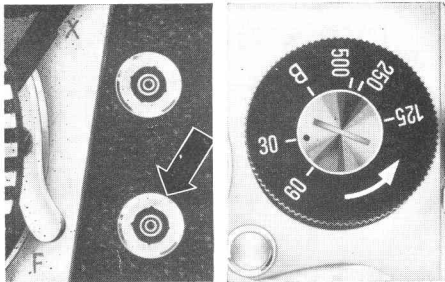

Use of fast-burning flashbulbs (open flash technique)

Connect the cable of the flashgun to the F contact (29) and set the shutter to $\frac{1}{30}$ second. The effective exposure time will be determined by the approximate duration of the flash and not by the shutter speed.

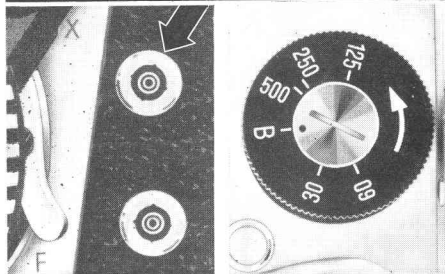

Use of all types of flashbulbs in the market (open flash technique)

Connect the cable of the flashgun to the X contact (12), and set the shutter to B. The effective exposure time will be determined by the approximate duration of the flash and not by the shutter speed. After the flash has lighted up, close the shutter immediately in order to avoid secondary exposures.

The following data apply to some of the well-known flashbulbs available

| Osram flashbulbs | | | Philips Photoflux flashbulbs | | | NARVA Photoflashbulbs | | |
|------------------|---------------------|---------------------|------------------------------|---------------------|---------------------|-----------------------|---------------------|---------------------------------|
| Type | Guide No. 40 ASA | Flash duration | Type | Guide No. 40 ASA | Flash duration | Type | Guide No. 40 ASA | Flash duration |
| AG 3 B | 86 | $\frac{1}{80}$ sec. | AG 3 B | 92 | $\frac{1}{80}$ sec. | X 1 (capless) | 59 | approx. $\frac{1}{125}$ sec. |
| XM 1 B | 86 | $\frac{1}{90}$ sec. | PF 1 B | 92 | $\frac{1}{90}$ sec. | | | |
| XM 5 B | 132 | $\frac{1}{70}$ sec. | PF 5 B | 132 | $\frac{1}{70}$ sec. | | | |

The following data apply to some of the well-known flashbulbs available

| Osram flashbulbs | | | Philips Photoflux flashbulbs | | | NARVA Photoflashbulbs | | |
|------------------|---------------------|---------------------|------------------------------|---------------------|---------------------|-----------------------|---------------------|---------------------------------|
| Type | Guide No. 40 ASA | Flash duration | Type | Guide No. 40 ASA | Flash duration | Type | Guide No. 40 ASA | Flash duration |
| AG 3 B | 86 | $\frac{1}{80}$ sec. | AG 3 B | 92 | $\frac{1}{80}$ sec. | X 1 (capless) | 59 | approx. $\frac{1}{125}$ sec. |
| XM 1 B | 86 | $\frac{1}{90}$ sec. | PF 1 B | 92 | $\frac{1}{90}$ sec. | | | |
| XM 5 B | 132 | $\frac{1}{70}$ sec. | PF 5 B | 132 | $\frac{1}{70}$ sec. | | | |
| XM 6 B | 115 | $\frac{1}{33}$ sec. | PF 6 B | 118 | $\frac{1}{33}$ sec. | | | |
| | | | PF 45 B | 145 | $\frac{1}{33}$ sec. | | | |
| | | | PF 60 B | 171 | $\frac{1}{70}$ sec. | | | |
| | | | PF 100 B | 211 | $\frac{1}{60}$ sec. | | | |
| | | | PF 45 | 198 | $\frac{1}{33}$ sec. | | | |
| | | | PF 60 | 244 | $\frac{1}{70}$ sec. | | | |
| | | | PF 100 | 293 | $\frac{1}{60}$ sec. | | | |

Care of the camera and lenses

Always keep the camera in its ever-ready case with the lens (or lenscap) and viewfinder unit in position; alternatively it may be kept wrapped in a fluff-free cloth. All parts which are easily accessible from the outside should be kept clean and dusted with a soft brush. This applies particularly to the film-guide runners (33), the film-wind sprocket (32), the film chambers (31 and 37) and also the camera back (38) including the pressure plate (39). The reflex mirror should only be dusted when absolutely necessary, using a clean soft brush without applying any pressure; do not allow the brush to touch the lightly-greased metal surround of the mirror. Protect the camera against moisture, dust, wind-borne sand, etc. Under no circumstances allow the camera to be pointed at the sun unless the lens is covered by a lenscap! By doing so, the lens would act as a magnifier, focusing the sun's rays sharply on the material of the focal-plane

shutter blinds and causing them to be burned.

Never touch the glass surfaces of the lenses, the focusing magnifier or the eyepiece of the Penta Prism or the mirror with the fingers. These glass surfaces should be cleaned when necessary only with an extremely soft piece of wash-leather or a soft, fluff-free linen cloth. It is highly inadvisable to attempt to interfere with the mechanism of the camera. Repairs should be undertaken only by authorized servicing agencies.

Accessories

Accessories increase the versatility of the EXAKTA VX 500 and are for some applications indispensable.

The following accessories are available:

Finder Hood

Penta Prism

Fresnel Screen with Microprism grid

Ground-glass Screen with Field Framing

Eyepiece cup for Penta Prism

Ever-Ready Case

Lens Hood with screw-in mount

Giant release button, to enlarge the release button

Accessory shoe

Special locking knob (for Domiplan 2.8/50 lens)

Bayonet rings and tubes, as well as Two-in-one ring, for close-ups

Miniature Bellows Attachment

Autocouple Extension Release, for close-ups

"Vielzweck" (Multi-Purpose) equipment for close-

ups, reproductions and macrophotography, etc., consisting of the following parts:

Swing Angle Attachment

Large Bellows Attachment

Transparency Copying Attachment

Copying Stand and Repro Unit

(with Lighting equipment, if required)

T 2.8/50 Special lens from Jena, in sunk mount

Lens Reversal Rings

Adapter Rings for using photomicrographic lenses

Lens Magnifier insert with Top Lens

Flat Ground-glass Screen

Special Image Field Screens

Macro-Micro Photometer

Ringflash Units RB 1 and RB 2

Kolpofot

Endoscope Attachment and Overrunning

Switch Unit

Spectroscope Adapter Ring

Adapter for Astrophotography

Microscope Attachment

Should you want further information on the ample assortment of accessories, we shall be pleased to send you any special leaflets. Kindly let us know your particular interests.

We would also recommend the following book:

"EXAKTA Manual" by Werner Wurst (Fountain Press, London).

This book is available from photographic dealers.

The illustrations in this manual may differ in certain details from the actual appearance of the camera and its accessories.

VX 500
Tessar 2.8
Penta Prism

Original

Dresden