

DIGITAL CAMERA  
*FinePix S2 Pro*



Getting Ready

Basic  
Photography

Advanced  
Photography

Advanced  
Features  
Playback

Settings

Connection

**OWNER'S MANUAL**

This manual will show you how to use your FUJIFILM DIGITAL CAMERA FinePix S2 Pro correctly.  
Please follow the instructions carefully.



## Warning

To prevent fire or shock hazard, do not expose the unit to rain or moisture.

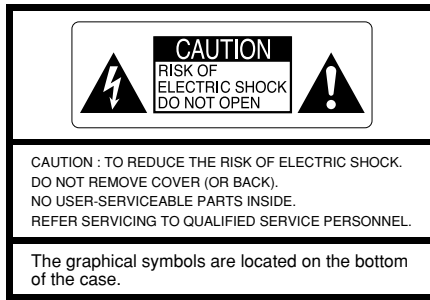

 This symbol is intended to alert the user to the presence of uninsulated "dangerous voltage" within the product's enclosure that may be of sufficient magnitude to constitute a risk of electric shock to persons.

 This symbol is intended to alert the user to the presence of important operating and maintenance (servicing) instructions in the literature accompanying the appliance.

## For customers in the U.S.A.

### FCC Statement

This device complies with part 15 of the FCC Rules. Operation is subject to the following two conditions: (1) This device may not cause harmful interference, and (2) this device must accept any interference received, including interference that may cause undesired operation.

### CAUTION

This equipment has been tested and found to comply with the limits for a Class B digital device, pursuant to Part 15 of the FCC Rules. These limits are designed to provide reasonable protection against harmful interference in a residential installation. This equipment generates, uses, and can radiate radio frequency energy and, if not installed and used in accordance with the instructions, may cause harmful interference to radio communications. However, there is no guarantee that interference will not occur in a particular installation. If this equipment does cause harmful interference to radio or television reception, which can be determined by turning the equipment off and on, the user is encouraged to try to correct the interference by one or more of the following measures:

- Reorient or relocate the receiving antenna.
- Increase the separation between the equipment and receiver.
- Connect the equipment into an outlet on a circuit different from that to which the receiver is connected.
- Consult the dealer or an experienced radio/TV technician for help.

You are cautioned that any changes or modifications not expressly approved in this manual could void the user's authority to operate the equipment.

#### Notes on the Grant:

To comply with Part 15 of the FCC rules, this product must be used with a Fujifilm-specified ferrite-core video cable, USB cable, IEEE1394 cable and DC supply cord.

## For customers in Canada

### CAUTION

This Class B digital apparatus complies with Canadian ICES-003.

**Please read the Safety Notes (⇒P.123) and make sure you understand them before using the camera.**

## EC Declaration of Conformity

We  
Name : Fuji Photo Film (Europe) G.m.b.H.  
Address : Heesenstrasse 31  
40549 Dusseldorf, Germany

declare that the product  
Product Name : FUJIFILM DIGITAL CAMERA FinePix S2 Pro  
Manufacture's Name : Fuji Photo Film Co., Ltd.  
Manufacture's Address : 26-30, Nishiazabu 2-chome, Minato-ku,  
Tokyo 106-8620, Japan

is in conformity with the following Standards

Safety : EN60065  
EMC : EN55022 : 1998 Classe B  
EN55024 : 1998  
EN61000-3-2 : 1995 + A1:1998 + A2:1998

following the provision of the EMC Directive (89/336/EEC, 92/31/EEC and 93/68/EEC) and Low Voltage Directive (73/23/EEC).



Dusseldorf, Germany

June 1, 2002

Place

Date

Signature/Managing Director



Bij dit produkt zijn batterijen geleverd. Wanneer deze leeg zijn, moet u ze niet weggooien maar inleveren als KCA

# Preface

## ■ Test Shots Prior to Photography

For particularly important photographs (such as weddings and overseas trips), always take a test photograph and view the image to make sure that the camera is functioning normally.

- Fuji Photo Film Co., Ltd. cannot accept liability for any incidental losses (such as the costs of photography or the loss of income from photography) incurred as a result of faults with this product.

## ■ Notes on Copyright

Images recorded using your digital camera system cannot be used in ways that infringe copyright laws without the consent of the owner, unless intended only for personal use. Note that some restrictions apply to the photographing of stage performances, entertainments and exhibits, even when intended purely for personal use. Users are also asked to note that the transfer of memory cards (SmartMedia or Microdrive) containing images or data protected under copyright laws is only permissible within the restrictions imposed by those copyright laws.

## ■ Liquid Crystal

If the LCD monitor is damaged, take particular care with the liquid crystal in the monitor or finder. If any of the following situations arise, take the urgent action indicated.

- If liquid crystal comes in contact with your skin  
Wipe the area with a cloth and then wash thoroughly with soap and running water.
- If liquid crystal gets into your eye  
Flush the affected eye with clean water for at least 15 minutes and then seek medical assistance.
- If liquid crystal is swallowed  
Flush your mouth thoroughly with water. Drink large quantities of water and induce vomiting. Then seek medical assistance.

## ■ Notes on Electrical Interference

If the camera is to be used in hospitals or aircrafts, please note that this camera may cause interference to other equipment in the hospital or aircraft. For details, please check with the applicable regulations.

## ■ Handling Your Digital Camera

This camera contains precision electronic components. To ensure that images are recorded correctly, do not subject the camera to impact or shock while an image is being recorded.

## ■ Trademark Information

- iMac and Macintosh are registered trademarks of Apple Computer, Inc.
- Microsoft, Windows, and the Windows logo are trademarks, or registered trademarks of Microsoft Corporation in the United States and/or other countries. Windows is an abbreviated term referring to the Microsoft Windows Operating System.
- \* The "Designed for Microsoft Windows XP" logo refers to the camera and the driver only.
- SmartMedia is a trademark of Toshiba Corporation.
- CompactFlash is trademark of Sandisk Corporation of the U.S.
- Microdrive is a trademark of the International Business Machines Corporation of the U.S.
- Other company or product names are trademarks or registered trademarks of the respective companies.

## ■ Explanation of Color Television System

NTSC: National Television System Committee, color television telecasting specifications adopted mainly in the U.S.A., Canada and Japan.

PAL: Phase Alternation by Line, a color television system adopted mainly by European countries and China.

## ■ Exif Print (Exif ver. 2.2)

Exif Print Format is a newly revised digital camera file format that contains a variety of shooting information for optimal printing.

# Camera Features and Accessories

## Features

- The newly developed large-size "Super CCD" built into the FinePix S2 Pro provides an ultra-high resolution, high sensitivity, a large dynamic range and an excellent S/N ratio.
- 6.17 million effective image pixels
- Over 12 million recorded image pixels (4256 × 2848 pixels)
- Supports uncompressed data output for CCD-RAW data
- Wide range of sensitivity settings from ISO 100 to ISO 1600
- Multifunctionality built in to meet the needs of professionals
- 5-point metering AF function
- Shutter speeds from 30 sec to 1/4000 sec.
- Equipped with a synchronizing terminal
- Quick, responsive operation with only 0.5 seconds between shots
- Dual slot for SmartMedia and Microdrives
- Supports 4 types of recorded pixel according to the type of shot
- You can specify independent ISO, color tone, gradation and sharpness settings just as if you were selecting a film type.
- Histogram function for instant exposure checking after you take a shot
- 1.8-inch low-temperature polysilicon TFT color LCD monitor provides 100% coverage
- IEEE1394 and USB connectivity for quick and easy image file downloading
- DPOF-compatible for simple image printing
- Conforms to "Design for Camera File system" standard and Exif ver.2.2 for digital cameras
- \* "Design for Camera File system" standard and Exif format are formulated by the Japan Electronics and Information Technology Industries Association (JEITA)

## Accessories

### ● Lithium Batteries CR123A (2)



### ● AA-size Alkaline Batteries (4)

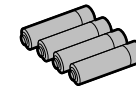

### ● Strap (1)



### ● Video Cable (approx. 1.5 m (4.9ft.), mini-plug (3.5 mm-dia.) to pin-plug cable) (1)

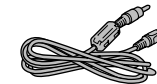

### ● Accessory Shoe Cover (1)

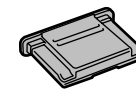

### ● Camera Body Cap (1)



### ● LCD Cover (1)



### ● Eyepiece Cap (1)

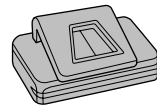

### ● Interface Set (1)

- CD-ROM: Software for FinePix EX (1)  
Photoshop Element (1)
- IEEE1394 4-pin to 6-pin cable (1)
- Special USB cable with Noise Suppression core (1)
- Software Quick Start Guide (1)
- Software Supplementary Guide (1)

### ● Owner's Manual (this manual) (1)

### ◆ LCD cover ◆

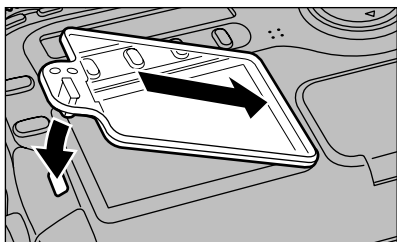

To prevent soiling or damage to the LCD monitor, attach the enclosed LCD cover to the camera when you are carrying or not using the camera. Attach the LCD cover by fitting it into the grooves to the right of the LCD monitor.

# Contents

Warning .....	2
EC Declaration of Conformity .....	3
Preface .....	4
Camera Features and Accessories .....	5
Nomenclature .....	9
Top display panel .....	12
LCD monitor .....	12
Rear display panel .....	13
Viewfinder display .....	14





## Getting Ready

ATTACHING THE STRAP .....	15
MOUNTING THE CAMERA LENS .....	16
Using Nikkor lenses with built-in CPUs other than G-type lenses .....	17
Lens Compatibility .....	18
LOADING THE MEDIA .....	20
SmartMedia™ (optional) .....	20
Microdrive (optional: supplied by another manufacturers) .....	20
LOADING THE BATTERIES .....	22
Compatible Batteries .....	22
Loading the lithium batteries .....	22
Loading the AA-size batteries .....	23
SWITCHING ON AND OFF • SETTING THE DATE AND TIME .....	24
CHECKING THE BATTERY LEVEL .....	25
■ When you have difficulty obtaining lithium batteries .....	25
■ Batteries Uses and Symptoms When Batteries are Depleted .....	25















## Basic Photography

BASIC OPERATION GUIDE .....	26
Command dials .....	29
TAKING PICTURES .....	30
NUMBER OF AVAILABLE SHOTS .....	32
■ Standard Number of Shots for the Media .....	32
USING AF LOCK .....	33
PLAYING BACK IMAGES .....	34
DIOPTRIC ADJUSTMENT/LCD ILLUMINATOR .....	35
DEPTH OF FIELD CHECK BUTTON/CCD PLANE INDICATOR .....	36

## Advanced Photography

FOCUS SETTINGS .....	37
■ Focus-related custom settings .....	37
SELECTING THE FOCUS MODE .....	38
■ Focus modes .....	38
SELECTING THE AF AREA MODE .....	39
Selecting the focus area .....	40
AF-ASSIST ILLUMINATOR .....	41
SITUATIONS WHERE AUTOFOCUS MAY NOT WORK AS EXPECTED .....	42
MANUAL FOCUS .....	43
Focus can be set manually when the focus mode selector is set to M. ....	43
Focus Aid .....	43
RELEASE MODES/  (SINGLE-FRAME) AND  (CONTINUOUS SHOOTING) .....	44
 (Single frame) .....	44
 (Continuous Shooting) .....	44

## Advanced Photography

METERING SYSTEMS .....	45
 : Matrix (10-segment) metering .....	45
 : Center-weighted metering .....	45
 : Spot metering .....	45
ISO SENSITIVITY/EXPOSURE MODES <b>P</b> .....	46
Program chart .....	47
EXPOSURE MODES <b>S</b> .....	48
<b>S</b> SHUTTER-PRIORITY AUTO .....	48
EXPOSURE MODES <b>A</b> .....	49
<b>A</b> APERTURE-PRIORITY AUTO .....	49
EXPOSURE MODES <b>M</b> .....	50
<b>M</b> MANUAL .....	50
Bulb Photography (“ <b>b u l b</b> ”) .....	52
 TAKING PICTURES WITH AE LOCK .....	53
 EXPOSURE COMPENSATION .....	54
 AUTO EXPOSURE BRACKETING .....	55
 MULTIPLE EXPOSURE .....	57
SELF-TIMER PHOTOGRAPHY .....	59
FLASH PHOTOGRAPHY .....	60
SETTINGS FOR FLASH PHOTOGRAPHY .....	60
BUILT-IN FLASH .....	61
■ Flash control modes that can be used with the built-in flash .....	61
SYNCHRO MODES AND THEIR FEATURES .....	62
 FRONT SYNCHRO MODE .....	62
 <b>SLOW</b> SLOW SYNCHRO MODE .....	62
 <b>REAR</b> REAR SYNCHRO MODE .....	63
 <b>RED-EYE</b> RED-EYE REDUCTION MODE .....	63
 <b>SLOW RED-EYE</b> RED-EYE REDUCTION SLOW SYNCHRO MODE .....	63
■ Shutter Speeds .....	63
TAKING PICTURES USING THE BUILT-IN FLASH .....	64
■ Effective Range of the Built-in Flash .....	65
LENSES THAT CAN BE USED WITH THE BUILT-IN FLASH .....	66
FLASH EXPOSURE COMPENSATION .....	67
To check the amount of compensation .....	67
To cancel exposure compensation .....	67
NIKON FLASH UNITS THAT CAN BE USED .....	68
USING THE FUNCTION MENU WHEN TAKING PICTURES .....	70
 <b>WHITE</b> BALANCE .....	71
 <b>AF AREA/QUALITY/RECORDED PIXELS</b> .....	72
AF AREA .....	72
QUALITY .....	73
RECORDED PIXELS .....	73
 <b>COLOR/TONE/SHARPNESS/FUNCTION LOCK</b> .....	74
COLOR .....	74
TONE .....	74
SHARPNESS .....	75
FUNCTION LOCK .....	75

**4 Advanced Features Playback**

USING THE FUNCTION MENU ..... 76

    FUNC HISTOGRAM ..... 77

        ■ About the Histogram Display ..... 77

    FUNC ERASING SINGLE-FRAME ..... 78

    FUNC SINGLE-FRAME PROTECT ..... 79

        ■ To check protected frames ..... 79

    FUNC MULTI-FRAME PLAYBACK ..... 80

    REC/OK PLAYBACK MENU ..... 81

        ERASE ..... 81

        ON SETTING AND REMOVING PROTECTION FOR ALL FRAMES ..... 83

    HOW TO SPECIFY PRINT OPTIONS (DPOF) ..... 84

    VOICE MEMO (AUDIO RECORDING) ..... 86

    LCD BRIGHTNESS ..... 88

**5 Settings**

SET-UP ..... 89

    ■ SET-UP Menu Options ..... 89

    Setup operations ..... 89

    IMAGE DISPLAY ..... 90

        Using the Preview Function ..... 90

    SETTING THE CUSTOM WB ..... 91

        ■ When the exposure is not measured correctly ..... 92

    VOICE MEMO ..... 93

    FRAME No. MEMORY ..... 94

    TWO-BUTTON RESET ..... 95

    CUSTOM SETTING (CSM) ..... 96

        Cancelling custom settings ..... 96

        ■ Custom Settings List ..... 97

**6 Connection**

CONNECTING TO A TV/USING THE AC POWER ADAPTER (OPTIONAL) ..... 99

CONNECTING TO A COMPUTER ..... 100

CONNECTING TO A COMPUTER VIA IEEE 1394 ..... 101

CONNECTING TO A COMPUTER VIA USB ..... 102

DISCONNECTING FROM THE PC (Important — always use this procedure.) ..... 103

System Expansion Options ..... 104

Accessories Guide ..... 105

Notes on Using Your Camera Correctly ..... 107

Cleaning the CCD ..... 108

Notes on the Power Supply ..... 112

    Applicable Batteries ..... 112

    Notes on the Batteries ..... 112

    Notes on Using the AC Power Adapter ..... 112

Notes on the Media (SmartMedia™ and Microdrives) ..... 113

Warning Displays ..... 114

Troubleshooting ..... 118

Specifications ..... 120

Explanation of Terms ..... 122

Safety Notes ..... 123

\* Refer to the pages in parentheses for information on using the camera features.

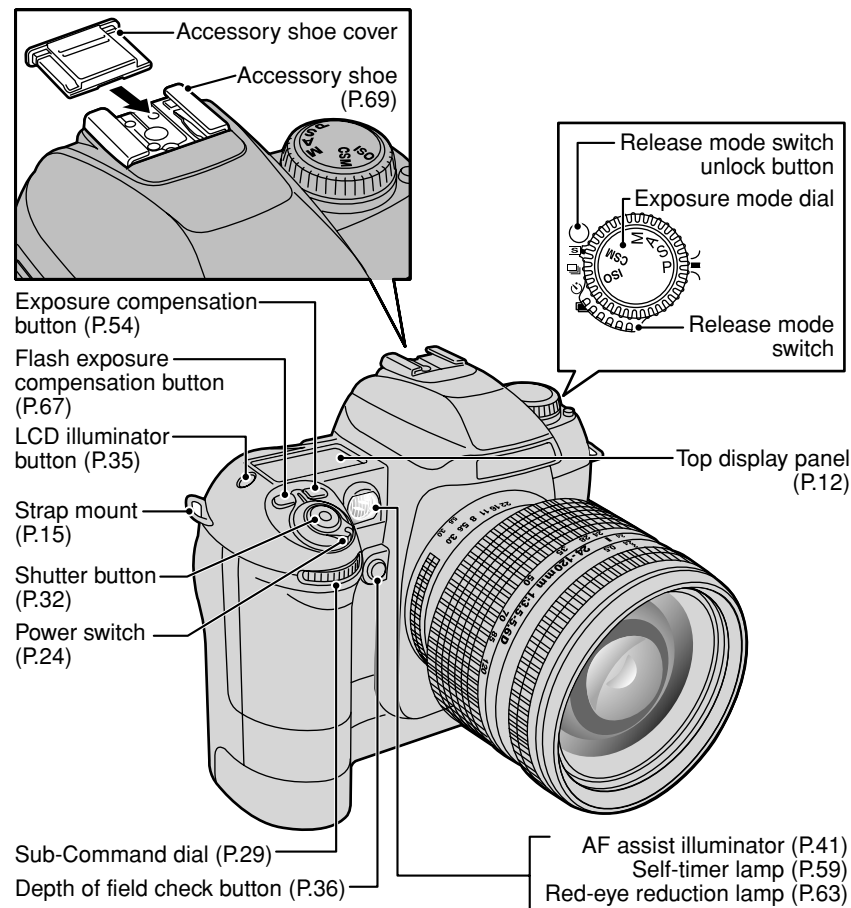

# Nomenclature

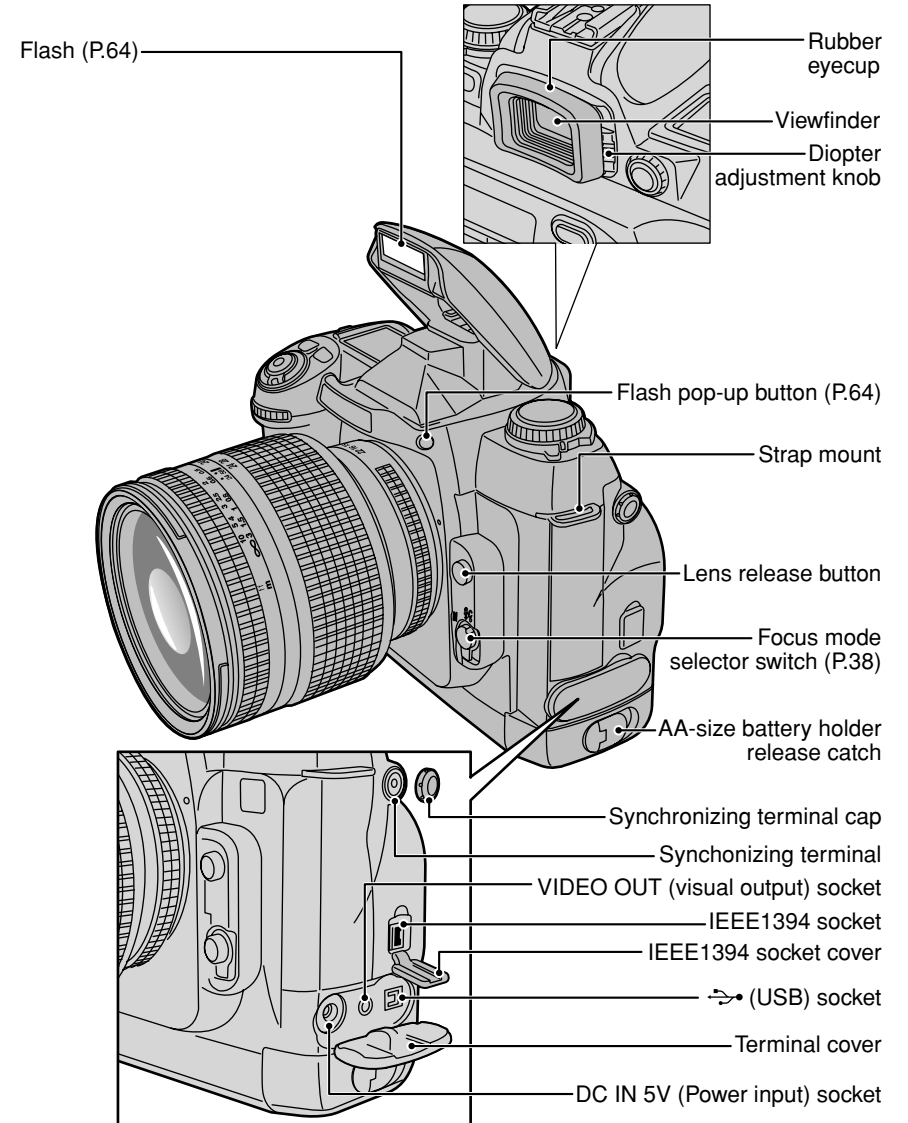
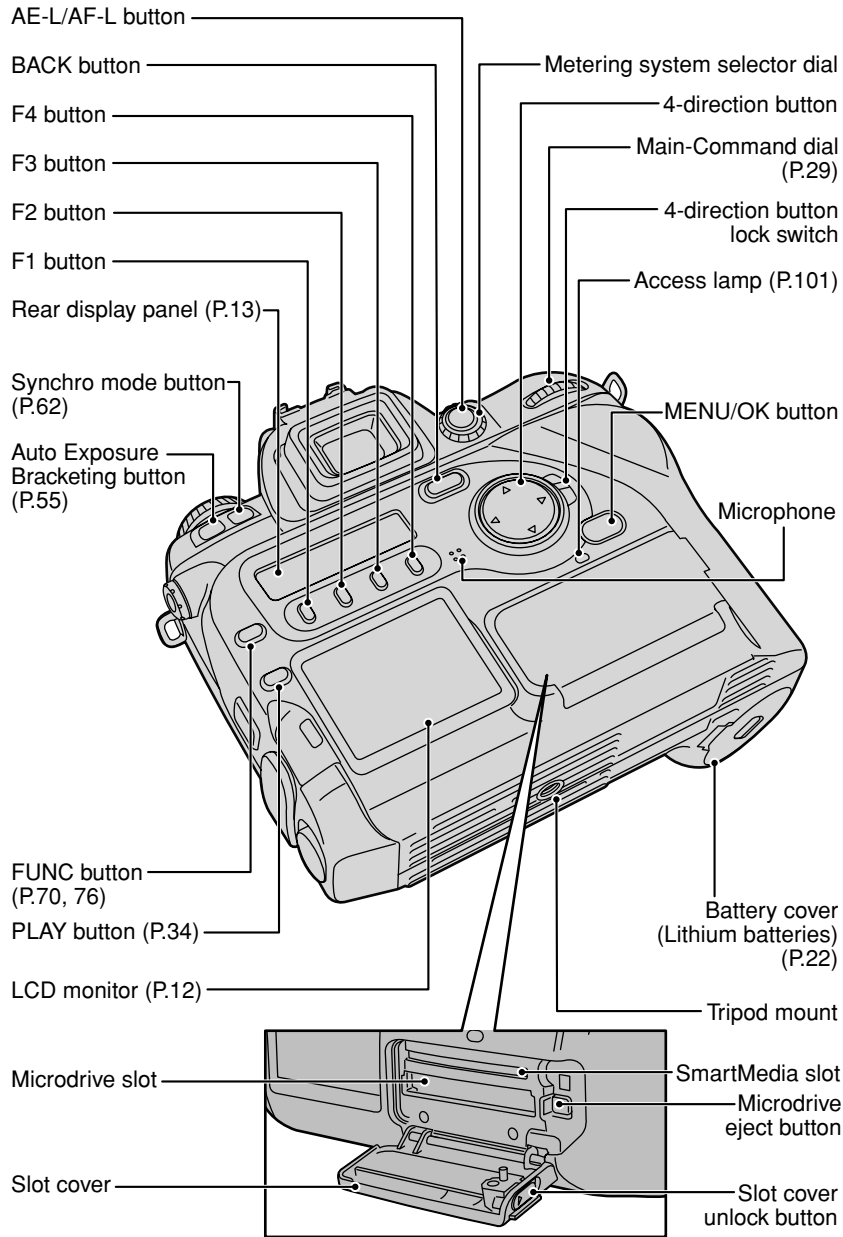

# Nomenclature

## Top display panel

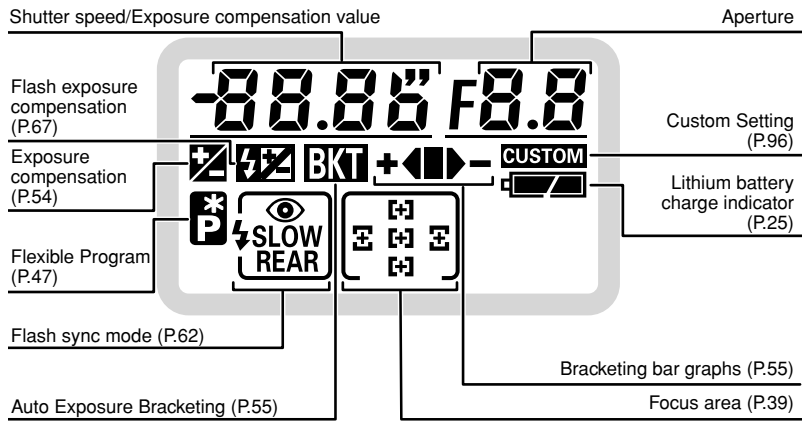

The LCD used in the top display panel will turn dark at high temperatures and will respond a little more slowly at low temperatures. However, it will operate normally again at normal temperatures.

## LCD monitor

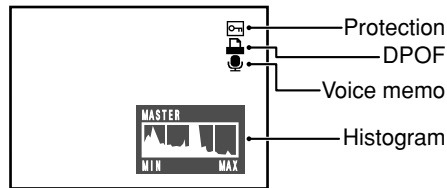

There may be some unevenness in the brightness at the bottom of the LCD monitor. This is due to variations in the lighting of the LCD itself and is not a fault.

## Rear display panel

### During shooting

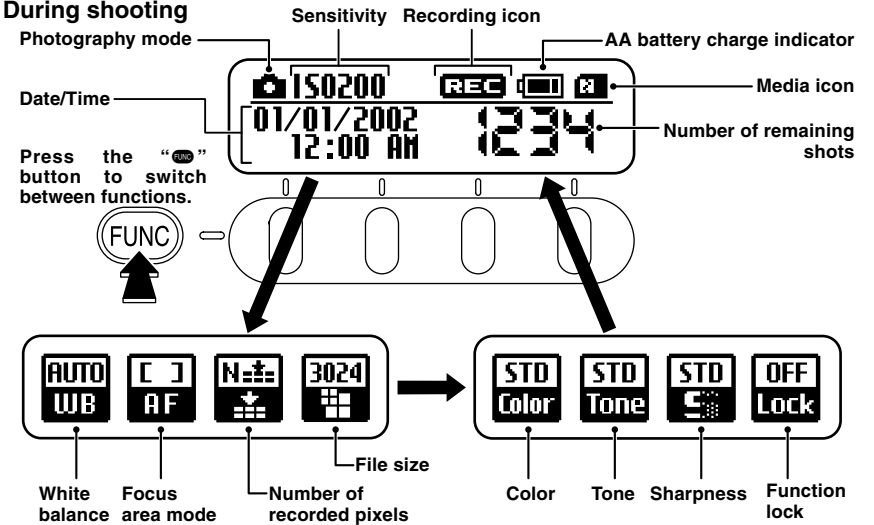

### When preview is selected

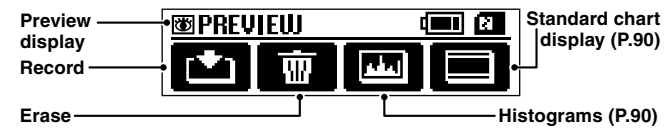

### During playback

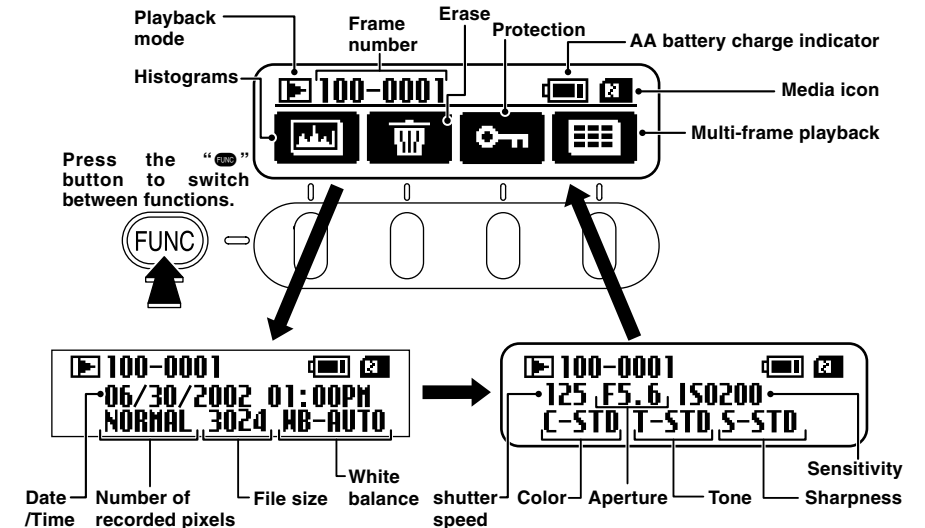

The LCD used in the rear display panel will turn dark at high temperatures and will respond a little more slowly at low temperatures. However, it will operate normally again at normal temperatures.

The frame number is highlighted for CCD-RAW images or non-DCF files.

## Viewfinder display

12mm-dia reference circle for Centre-weighted Metering area (P.45) On-Demand Grid Lines (P.97)

Focus area Spot Metering area (P.45)

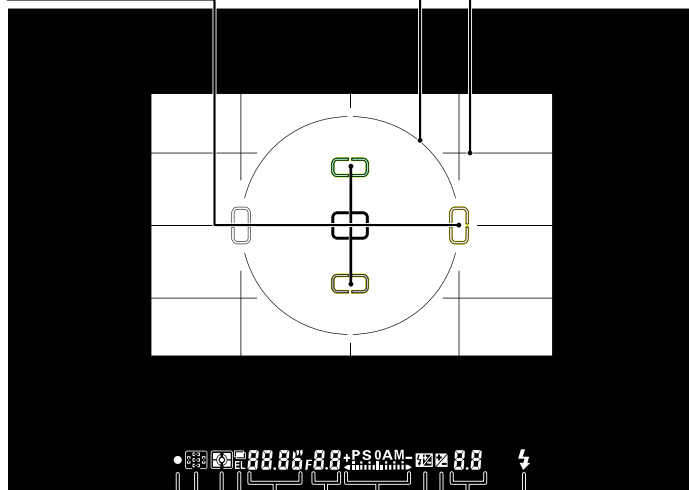

● Viewfinder information display	Flash ready-light (P.64)
Focus indicator (P.32)	Exposure compensation value /Flash exposure compensation value (P.54/67)
Focus area (P.39)	Exposure compensation (P.54)
Metering system (P.45)	Fish exposure compensation (P.67)
Multiple exposure (P.57)	Exposure mode (P.46-52)/Electronic analog exposure display/Exposure compensation value display (P.54)
AE-L (Auto exposure lock) indicator (P.53)	
Shutter speed	
Aperture	

- ⚠ The viewfinder will be dark without Lithium battery power but brightens after installation of fresh batteries. This is not a malfunction.
- ⚠ The LCD panel in the upper part of the viewfinder (focus area and framing guides) will become paler at high temperatures and will become darker and respond a little more slowly at low temperatures. However, it will operate normally again at normal temperatures.
- ⚠ The LCD panel in the viewfinder display (where the icons and numbers are displayed) will turn dark at high temperatures and will respond a little more slowly at low temperatures. However, it will operate normally again at normal temperatures.

### ◆ About Advanced Focusing Screen Display ◆

The new Advanced Focusing Screen Display of the FinePix S2 Pro employs the convenient Vari-Brite Focus Area display system; it enables clear display of the focus brackets at the selected focus area in the viewfinder for easy identification. When the finder image is bright, the focus brackets are displayed in black and when the finder image is dark, the focus brackets are momentarily illuminated in red. The selected focus area can be identified easily in both bright and dark conditions with this function.

Also, the new Advanced Focusing Screen Display allows the superimposition of On-Demand Grid Lines. The grid lines can be displayed by using Custom Setting Menu #2 (→P.96). These grids assist you in composing the frame, in taking landscape pictures or in shifting/tilting PC-Nikkor lenses.

\* Due to characteristics of the LCD used in the Vari-Brite Focus Area display system, a thin line outside the selected focus area may also be displayed or the entire viewfinder may be illuminated in red under certain conditions. These are not malfunctions.

1

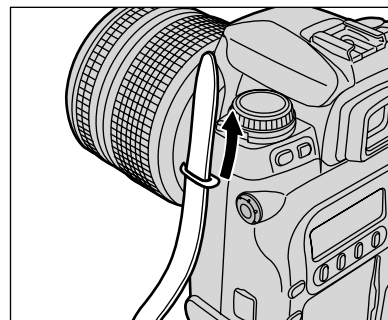

Pass one end of the strap through the strap mount on the camera body.

2

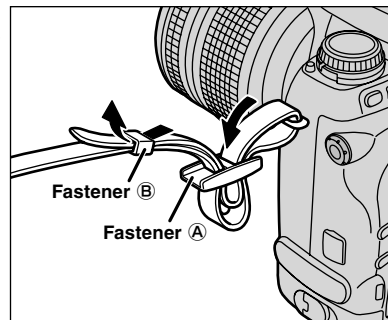

Pass the end of the strap through the fastener (A) and (B) as shown in the figure.

3

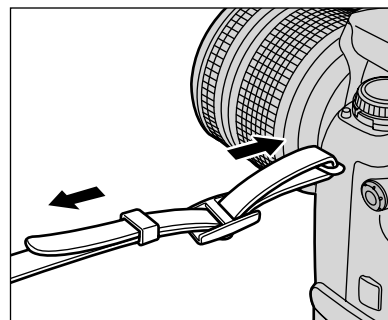

Adjust the strap length. Use the same procedure to attach the other end of the strap to the other strap mount.

- ⚠ Check that the strap is pulled tight after it is attached.



# MOUNTING THE CAMERA LENS

## 1 Check the lens type.

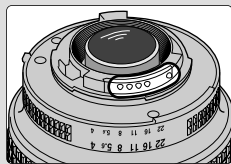

**CPU contacts of CPU lens**  
The lens is fitted with CPU signal contacts.

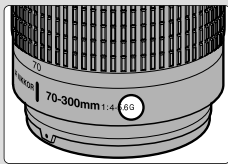

**G-type Nikkor lens**  
(without aperture ring)

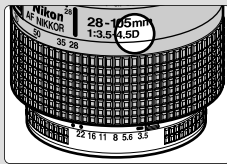

**CPU Nikkor lens other than G-type**  
(with aperture ring)

See "Lenses that can be used with this camera" (→P.18) for details.

## 2

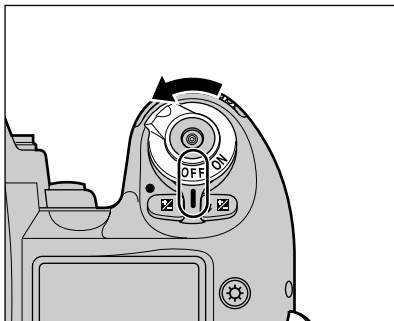

Set the power switch to OFF to switch the camera off.

## 3

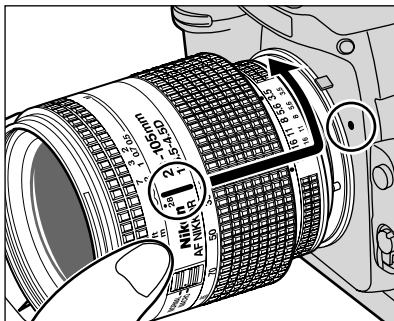

Position lens in the camera's bayonet mount so that the mounting indexes on lens and camera body are aligned, then twist lens counterclockwise until it locks into place.

- Always change the lens in an area free of dirt and dust.
- When attaching the lens, take care not to press the lens release button.
- When the lens is not attached or when a non-CPU Nikkor lens is attached and the power switch is turned on, "F- -" blinks in the top display panel and viewfinder, and the shutter cannot be released. See page 19 for a non-CPU lens.
- Take care not to mount the lens when it is at an angle to the camera as this can damage the lens mount on the camera.

## Using Nikkor lenses with built-in CPUs other than G-type lenses

### 1

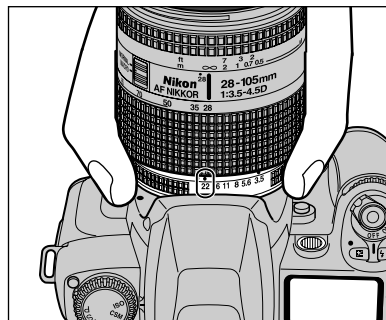

Set the aperture ring to the smallest aperture.

### 2

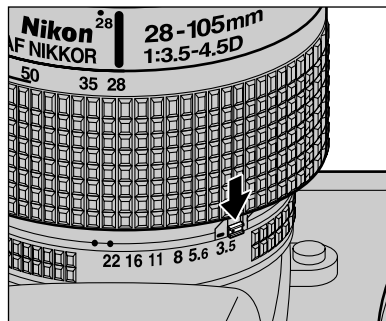

Lock the aperture ring. If you switch the camera on without first selecting the smallest aperture (the aperture setting with the highest number), "FE E" flashes on the top display panel and in the viewfinder, and the shutter will not operate.

### Removing the lens

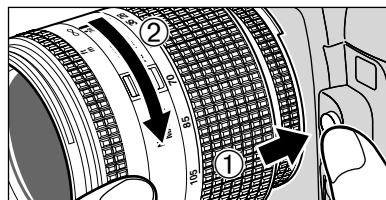

Push and hold the lens release button, then turn the lens clockwise.

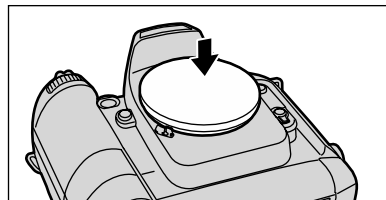

While the lens is removed from the camera, fit the camera body cap provided onto the camera to protect the inside of the camera and prevent soiling of the mirror and viewfinder screen. (You can also use the Nikon BF-1A Body Cap.)

## MOUNTING THE CAMERA LENS

### Lens Compatibility

Use a CPU lens (except IX-Nikkor) with this camera. D- or G-type AF lenses give you access to all available functions. See page 16

### Types of CPU lenses and other usable lenses/accessories

Lens/accessories	Mode	Focus mode			Exposure mode		Metering system		
		Autofocus	Manual with electronic rangefinder	Manual	Any mode other than M	M	Matrix		Centre-Weighted, Spot*1
							3D 10-segment	10-segment	
CPU Nikkor*2	D-type AF Nikkor*3, G-type AF Nikkor, AF-S, AF-I Nikkor	○	○	○	○	○	○	—	○
	PC Micro-Nikkor 85 mm f/2.8D*4	—	○*5	○	—	○	○	—	○
	AF-I Teleconverter*6	○*7	○*7	○	○	○	○	—	○
	Non-D/G-type AF Nikkor (except AF Nikkor for F3AF)	○	○	○	○	○	—	○	○
	AI-P Nikkor	—	○*8	○	○	○	—	○	○
Non-CPU Nikkor*9	AI-S or AI type Nikkor, Series-E, AI-modified Nikkor	—	○*8	○	—	○*10	—	—	—
	Medical-Nikkor 120 mm f/4	—	○	○	—	○*11	—	—	—
	Reflex-Nikkor	—	—	○	—	○*10	—	—	—
	PC-Nikkor	—	○*5	○	—	○*10	—	—	—
	AI-S or AI type Teleconverters	—	○*7	○	—	○*10	—	—	—
	Bellows Focusing Attachment PB-6*12	—	○*7	○	—	○*10	—	—	—
Auto Extension Rings (PK-11A, PK-12, PK-13 and PN-11)	—	○*7	○	—	○*10	—	—	—	

- \* 1 Spot Metering area can be shifted with focus area selector (➡P.45) with CPU Nikkor lens.
- \* 2 IX-Nikkor lenses cannot be attached.
- \* 3 This camera is compatible with the Vibration Reduction function of the VR Nikkor lens.
- \* 4 The camera's exposure metering and flash control system do not work properly when shifting and/or tilting the lens, or when using an aperture other than the maximum aperture.
- \* 5 Without shifting and/or tilting the lens.
- \* 6 Compatible with AF-S and AF-I Nikkor except AF-S 17-35 mm f/2.8D IF-ED and AF-S 28-70 mm f/2.8D IF-ED.
- \* 7 With maximum effective aperture of f/5.6 or faster.
- \* 8 With maximum aperture of f/5.6 or faster.
- \* 9 Some lenses/accessories cannot be attached (➡P.19).
- \* 10 With exposure mode set to Manual. The exposure meter cannot be used.
- \* 11 With exposure mode set to Manual and shutter speed set to 1/125 sec. or slower but the exposure meter cannot be used.
- \* 12 Attach the PB-6 vertically (PB-6 can be set to horizontal position after attaching).
  - AS-15 must be attached in combination with Medical-Nikkor 200 mm f/5.6 for the lens to fire flash.
  - Reprocoply Outfit PF-4 can be attached in combination with Camera Holder PA-4.

### G-type Nikkor and other CPU Nikkor lens

- The G-type Nikkor lens has no aperture ring; aperture should be selected from camera body. Unlike other CPU Nikkor lenses, aperture does not need to be set to minimum (largest f-number).
- CPU Nikkor lenses other than G-type Nikkor lens have an aperture ring. Set the lens aperture to its minimum and lock. When the lens is not set to its minimum aperture setting and the power switch is turned on, "FE E" blinks in the top display panel and viewfinder and the shutter cannot be released.

### When a non-CPU lens is attached

Set exposure mode to "M" Manual with a non-CPU lens. (When other modes are selected, shutter cannot be released.) The camera's exposure meter cannot be used and the aperture cannot be set using the Sub-Command Dial when using non-CPU lenses. "F- -" appears in place of the aperture indication in the top display panel and viewfinder; set/confirm aperture using the lens aperture ring.

### Nikkor lenses/accessories that cannot be attached to the FinePix S2 Pro

The following Nikkor lenses/accessories cannot be attached to the FinePix S2 Pro (otherwise camera body or lens may be damaged):

- TC-16A Teleconverter
- Non-AI lenses
- 400mm f/4.5, 600 mm f/5.6, 800 mm f/8 and 1200 mm f/11 with Focusing Unit AU-1
- Fisheye 6 mm f/5.6, 7.5 mm f/5.6, 8 mm f/8 and OP 10 mm f/5.6
- Old type 21 mm f/4
- K1, K2 ring, Auto Extension Ring PK-1, PK-11, Auto Ring BR-2, BR-4
- ED 180-600 mm f/8 (No. 174041-174180)
- ED 360-1200 mm f/11 (No. 174031-174127)
- 200-600 mm f/9.5 (No. 280001-300490)
- 80 mm f/2.8, 200 mm f/3.5 and TC-16 Teleconverter for F3AF
- PC 28 mm f/4 (No. 180900 or smaller)
- PC 35 mm f/2.8 (No. 851001-906200)
- Old type PC 35 mm f/3.5
- Old type Reflex 1000 mm f/6.3
- Reflex 1000 mm f/11 (No. 142361-143000)
- Reflex 2000 mm f/11 (No. 200111-200310)

# LOADING THE MEDIA

You can use either SmartMedia or Microdrive as recording media in the FinePix S2 Pro.

- If a SmartMedia and Microdrive are both loaded into the camera at the same time, images are recorded on the media selected in SET-UP (→ "Setup" P.89).
- Data cannot be copied between the two media types on the FinePix S2 Pro.

## SmartMedia™ (optional)

Always use 3.3-volt SmartMedia.

- MG-4S (4MB)
- MG-8S (8MB)
- MG-16S (16MB)
- MG-16SW (16MB, ID)
- MG-32S (32MB)
- MG-32SW (32MB, ID)
- MG-64SW (64MB, ID)
- MG-128SW (128MB, ID)

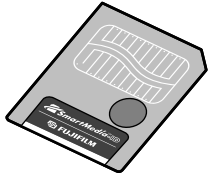

- ⚠ Images cannot be recorded or erased if a write-protect sticker is affixed to the SmartMedia.
- ⚠ Operation of this camera is only guaranteed when it is used with FUJIFILM SmartMedia.
- ⚠ Some 3.3V SmartMedia are labeled as "3V" or "ID" cards.
- ⚠ See P.113 for more information on using SmartMedia.

## Microdrive (optional: supplied by another manufacturers)

- Microdrive 340MB
- Microdrive 1GB

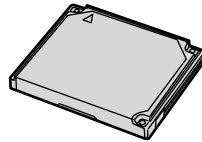

- ⚠ Microdrives are actually very small and light hard disks. Because they are a spinning storage medium, they are less resistant to vibration and impacts than SmartMedia. If you are using a Microdrive, take great care not to expose the camera to vibration or impacts (particularly during recording or playback).
- ⚠ The use of Ni-MH (nickel-metal hydride) batteries is recommended when using as Microdrive.
- ⚠ See P.113 for more information on using Microdrive.

Some CompactFlash™ cards may not work properly. Please contact the card manufacture for compatibility.

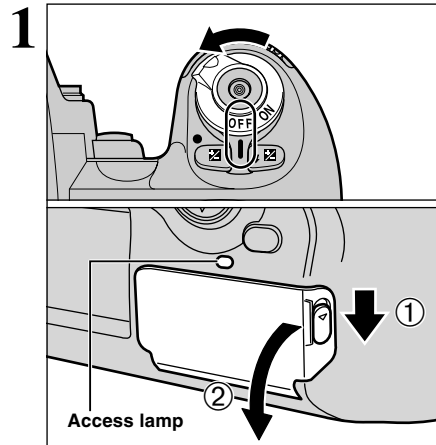

Set the power switch to "OFF" and check that the Access lamp is off. Then open the slot cover.

Never open the media slot cover while the camera is switched on. This could destroy the image data or damage the SmartMedia itself.

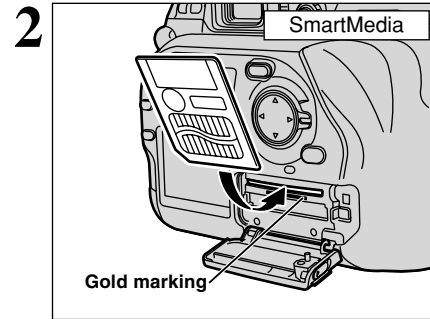

Align the contact area (gold-colored section) on the SmartMedia with the gold marker on the SmartMedia slot and push the SmartMedia firmly all the way into the slot.

- ⚠ If you open the slot cover while the camera is still switched on, the camera is switched off as a safety measure.
- ⚠ If the media is oriented incorrectly, it will not go all the way into the slot. Do not apply excessive force when inserting a SmartMedia or Microdrive.

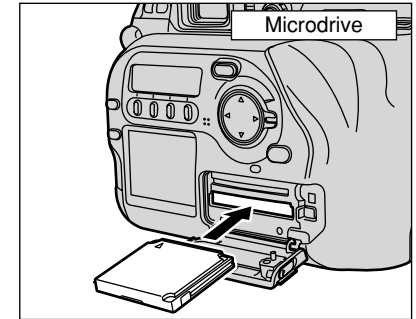

Push the Microdrive firmly all the way into the Microdrive slot.

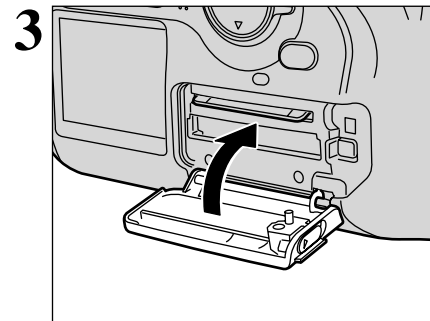

Close the slot cover.

### ◆ Replacing a SmartMedia ◆

Set the power switch to "OFF", check that the Access lamp is off and then open the slot cover. If you push the SmartMedia gently into the slot, it pops out for easy removal.

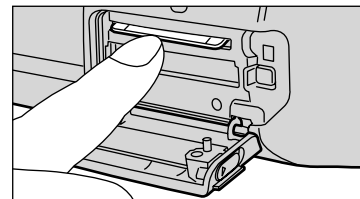

- ⚠ When storing SmartMedia, always use the special anti-static case provided.

### ◆ Replacing a Microdrive ◆

Set the power switch to "OFF", check that the Access lamp is off and then open the slot cover. Then press the eject button and remove the Microdrive.

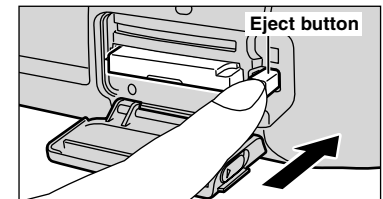

- ⚠ When storing Microdrives, always use the special protective case provided.

# LOADING THE BATTERIES

## Compatible Batteries

- CR123A batteries: 2 (lithium)
- AA batteries: 4 (alkaline or nickel-metal hydride)

### ◆ About the Batteries ◆

- Never use a battery when the outer casing is split or peeling as this could result in a short-circuit and cause major problems due to battery fluid leakage or overheating.
- Do not use AA-size lithium, manganese or nickel-cadmium (Ni-Cd) batteries.
- Do not use batteries of different types or brands together and do not use new batteries together with used batteries.
- The useful life of alkaline batteries varies depending on the brand. The life of some batteries may be considerably shorter than the batteries supplied with the camera. Due to the nature of alkaline batteries, the time for which they can be used is shorter in cold locations (+10°C (+50°F) or below).
- Soiling such as fingermarks or grease on the poles of batteries can significantly reduce the number of shots that can be taken.
- See P.112 for other precautions concerning the use of batteries.

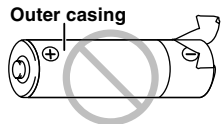

## Loading the lithium batteries

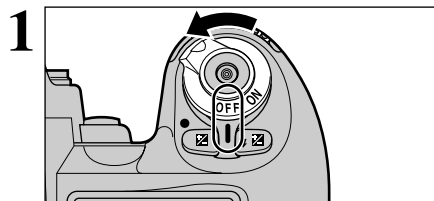

1 Set the power switch to OFF to switch the camera off.

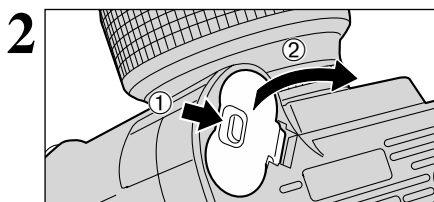

2 Open the battery compartment cover.

⚠ Do not apply excessive force to the battery cover.

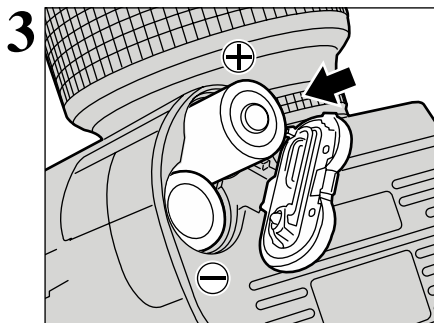

3 Load the lithium batteries in the direction indicated by the ⊕ and ⊖ labels on the camera.

⚠ Take care not to drop the batteries when opening or closing the battery cover.

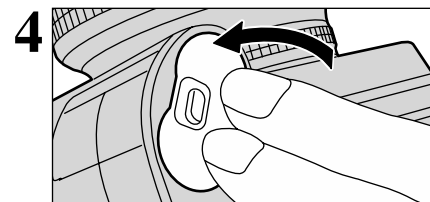

4 Firmly close the battery compartment cover.

## Loading the AA-size batteries

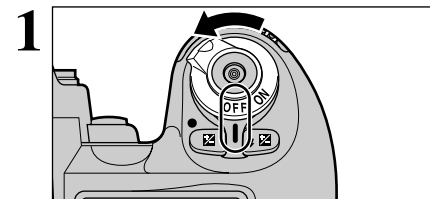

1 Set the power switch to OFF to switch the camera off.

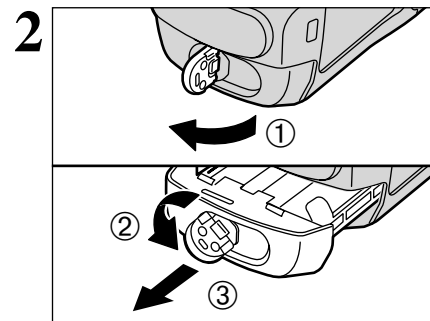

- ① Lift out the battery holder lock tab.
- ② Turn the battery holder lock tab counterclockwise to unlock the battery holder.
- ③ Pull the battery holder out.

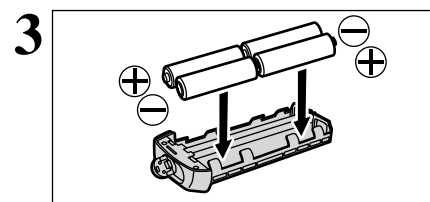

3 Load the AA-size batteries in the direction indicated by the ⊕ and ⊖ labels on the holder.

⚠ Remove the batteries more easily by pushing the batteries upwards from the gap at the opposite end from the battery holder lock tab.

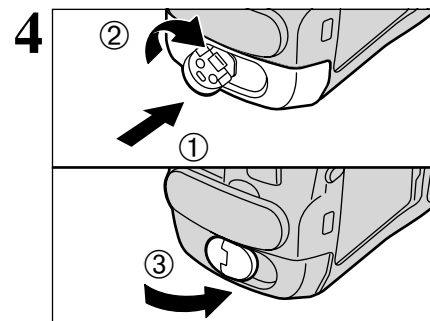

4 Push the battery holder in and hold it in place as you turn the battery holder lock tab clockwise to securely lock the battery holder.

## SWITCHING ON AND OFF • SETTING THE DATE AND TIME

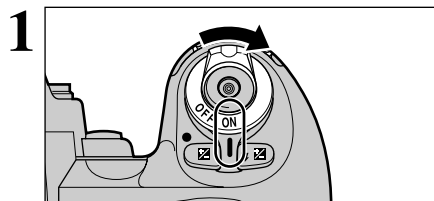

To switch the camera on, set the Power switch to "ON".  
To switch the camera off, set the Power switch to "OFF".

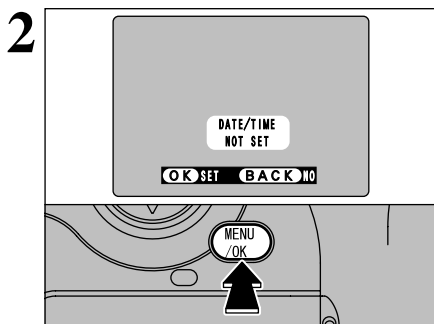

When you first switch the camera on, the date is cleared. Press the "MENU/OK" button to set the date and time.

④ To set the date and time later, press the "BACK" button.  
④ If you do not set the date and time, this confirmation message will appear each time you switch the camera on.

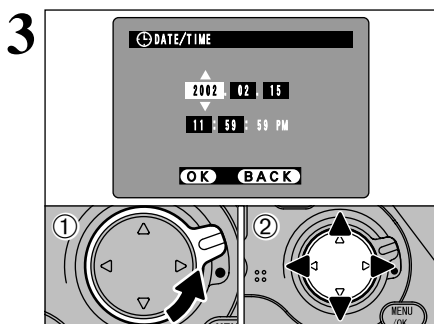

① Unlock the 4-direction button.  
② Press "◀" or "▶" to select year, month, day, hour or minute and then press "▲" or "▼" to adjust the selected setting.

④ If you hold down "▲" or "▼", the numbers change continuously.  
④ When the time displayed passes "12:00:00", the AM/PM setting automatically switches.

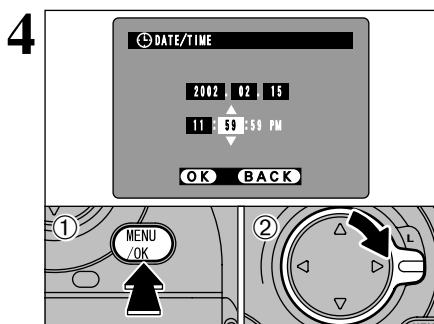

① Press the "MENU/OK" button. This switches the camera to Photography mode.  
② When you have finished the procedure, lock the 4-direction button to prevent accidental improper use.

④ To set the time precisely, press the "MENU/OK" button when the time is at zero seconds.  
④ Once the AC power adapter has been connected or the batteries have been loaded for 2 days or more, the date and time settings will be retained for roughly 6 months even when the camera has no power (batteries removed and AC power adapter disconnected).

### To correct the date/time

- ① Press the "MENU/OK" button to display the SET-UP screen.
- ② Use "▲" or "▼" to select "DATE/TIME" and then press "▶".

## CHECKING THE BATTERY LEVEL

Switch the camera on and check the battery charge indicator.

- ① There is ample charge in the batteries.
- ② The batteries are low on charge and will run out shortly. You should replace the batteries.
- ③ The batteries are fully depleted. You must replace the batteries. The display switches off and the camera stops operating, after which the display lights again.

Loss of power while an image is being saved will prevent the image from being saved successfully. Take note of the battery level when you are taking shots where image saving will take some time (continuous shooting or when the quality is set to "HIGH").

Lithium batteries (Top display panel)

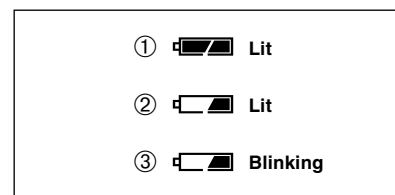
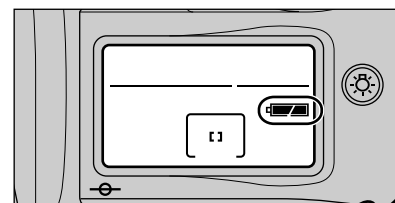

AA-size batteries (Rear display panel)

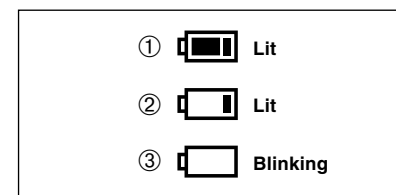
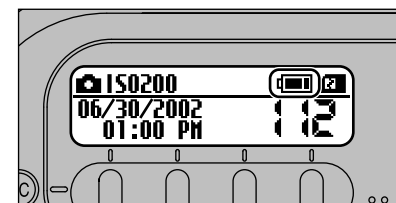

### ■ When you have difficulty obtaining lithium batteries

You can take pictures using only the four AA-size Ni-MH (nickel-metal hydride batteries), but the built-in flash cannot be used. When you are using only the four AA-size Ni-MH batteries, remove the used lithium batteries from the camera.

The time for which the camera can be used is shorter, and as far as possible this should only be used as an emergency measure. Note that the displays on the top and rear display panels both function as battery level indicators for the AA-size Ni-MH batteries.

- \* When you are taking pictures in locations where you think you will have difficulty purchasing lithium batteries, it is a good idea to take along some spare lithium batteries or carry some fully charged Ni-MH batteries for emergencies.
- \* The camera cannot be used just with alkaline batteries.

### ■ Batteries Uses and Symptoms When Batteries are Depleted

	Uses	Symptoms When Depleted
AA-size Alkaline batteries	Image processing	"E r r" appears on the top display panel
Lithium batteries CR123A	Power functions such as auto focus, aperture, mirror and shutter operation, and charge the flash.	The camera will not switch on.

### ◆ Auto Power Off Function ◆

If you leave the camera switched on without using it, this function automatically switches the camera off (➡P.98).

If the Auto Power Off function has shut down the camera, restore power to the camera by pressing the shutter button down halfway or pressing the LCD illuminator button. A small amount of battery charge is consumed even when Auto Power Off has shut down the camera.

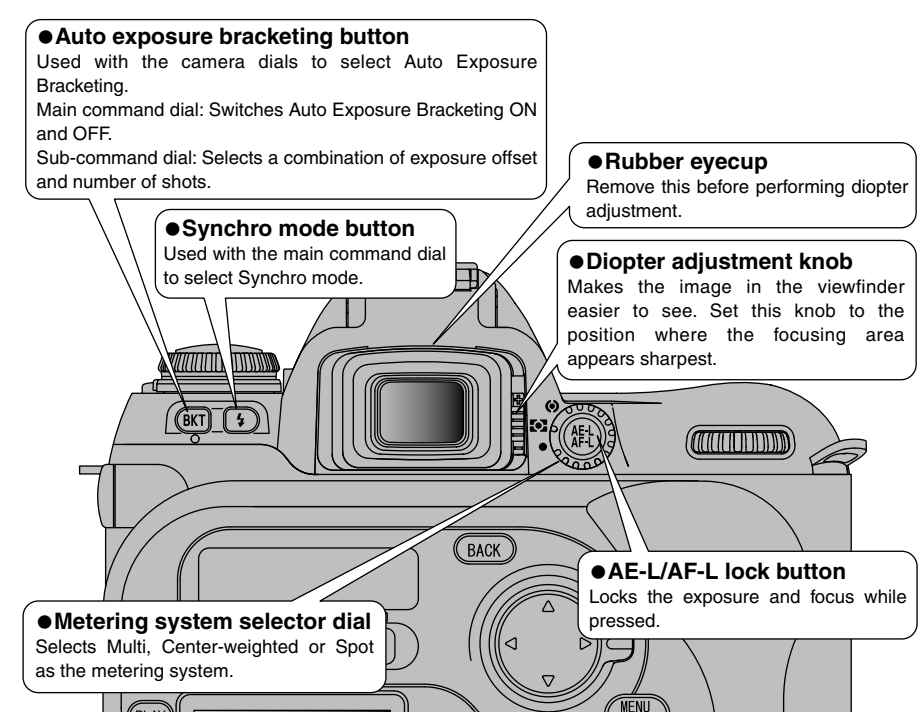
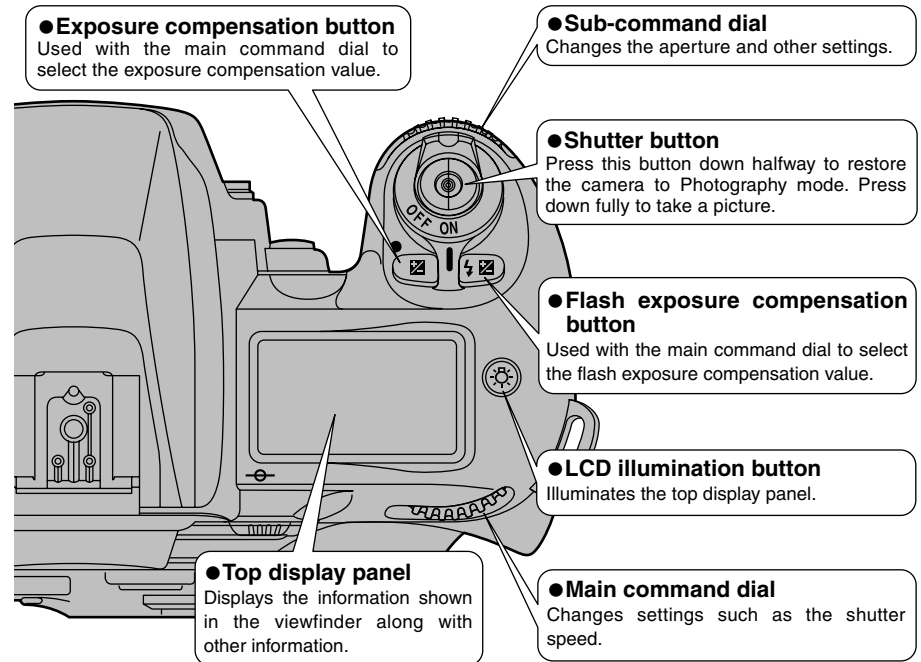
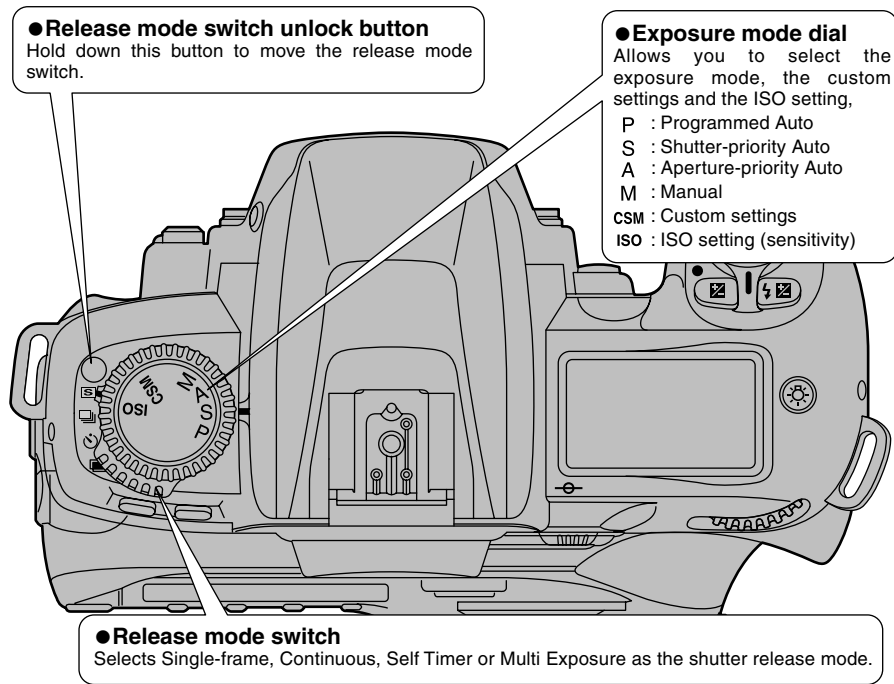
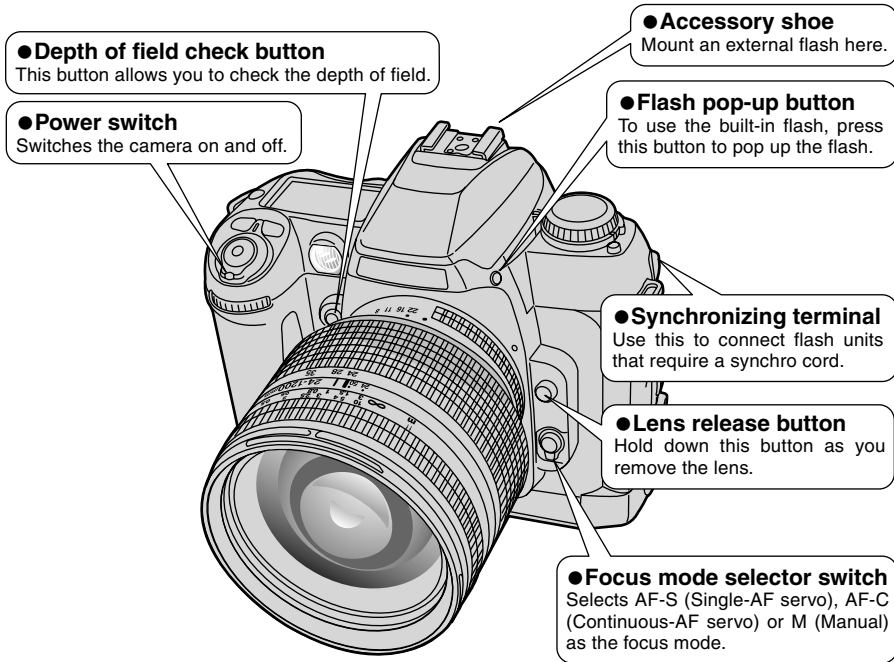

# BASIC OPERATION GUIDE

- FUNC button**  
 Selects the information displayed on the rear display panel.
- Rear display panel**  
 Displays information during shooting or playback.
- BACK button**  
 Press this button to cancel an action in the menu screen.
- 4-direction button lock switch**  
 Release this switch to use the 4-direction button.
- F1 to F4 buttons**  
 Use these buttons to select items in the rear display panel.
- MENU/OK button**  
 Press the button to confirm an action in the menu screen.
- 4-direction button**  
 Use this button to select menu options or the focus area.
- PLAY button**  
 Switches playback display on and off.

## ●Playback, Menu and SET-UP Operations

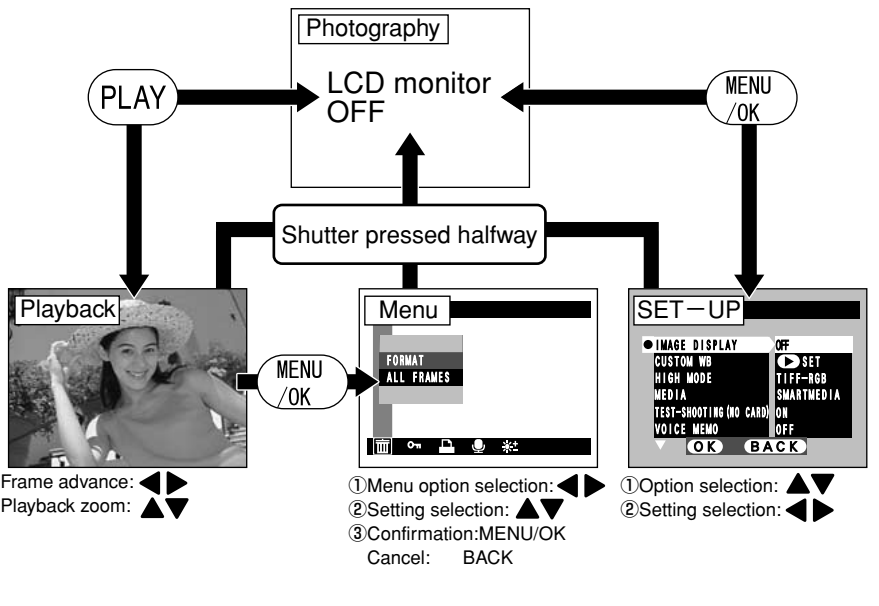

## Command dials

The FinePix S2 Pro's Main- and Sub-Command dials are used alone or in combination with other buttons to select/set various functions or modes.

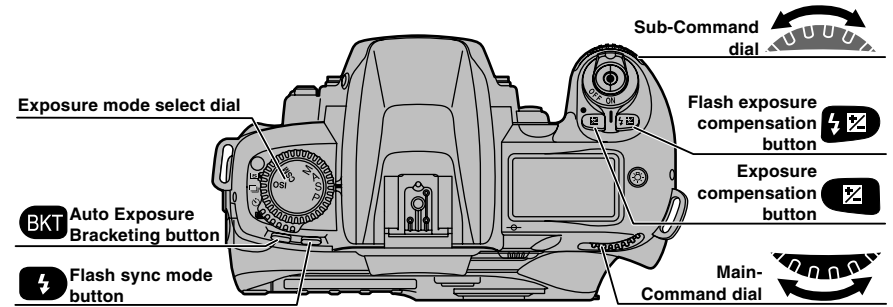

Setting	Exposure mode setting	Procedure
Program shift	"P"	Main ◀▶
Shutter speed	"S, M"	Main Slower ◀▶ Faster
Aperture setting	"A, M"	Sub Open ◀▶ Aperture
Exposure compensation amount	"P, S, A, M"	Main + ◀▶
Auto Exposure Bracketing ON/OFF	"P, S, A, M"	Main + ◀▶
Number of shots and exposure offset for Auto Exposure Bracketing		Sub + ◀▶
Synchro mode setting	"P, S, A, M"	Main + ◀▶
Flash exposure compensation amount		Main + ◀▶
Sensitivity setting	"ISO"	Main ◀▶
Custom setting option selection	"CSM"	Main ◀▶
Custom setting option modification		Sub ◀▶

# TAKING PICTURES

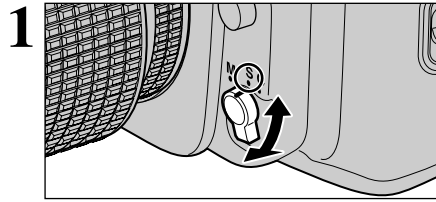

1 Set the focus mode selector to “S” (Single-AF Servo).

Make sure to turn the focus mode selector until it clicks into position.

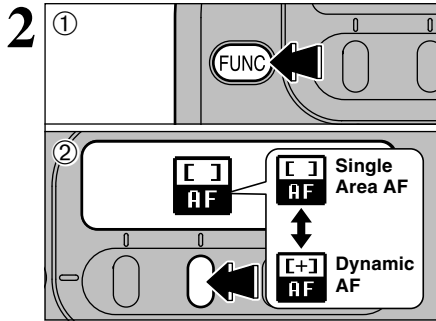

1 Press the “FUNC” button to display the AF setting on the rear display panel.  
2 Press the “F2” button to select “AF” single area.

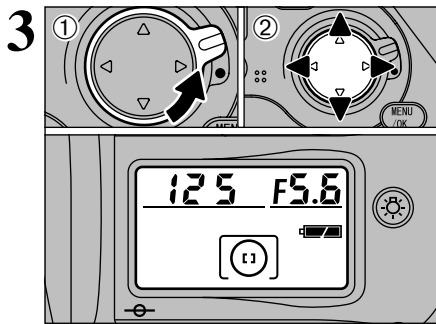

1 Unlock the 4-direction button.  
2 Press “◀”, “▶”, “▲” or “▼” to position the focusing area in the center.

The selected focus area indicator appears on the top display panel, in the viewfinder display and on the viewfinder screen (P.39).

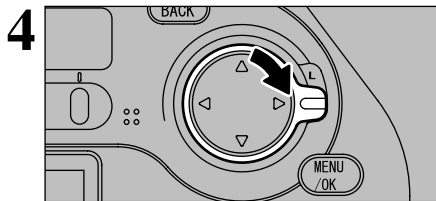

Lock the 4-direction button to prevent accidental improper use.

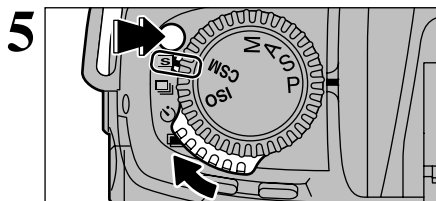

Hold down the release mode switch unlock button and set the release mode switch to “S” (Single-frame).

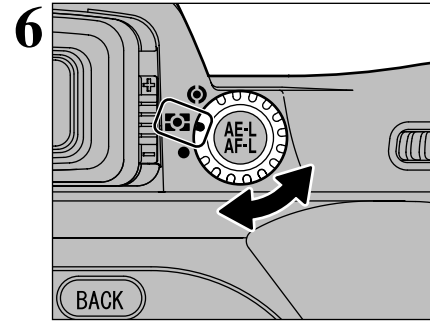

6 Set the metering system selector to “M” (Matrix Metering).

Matrix Metering indication “M” appears in the viewfinder.

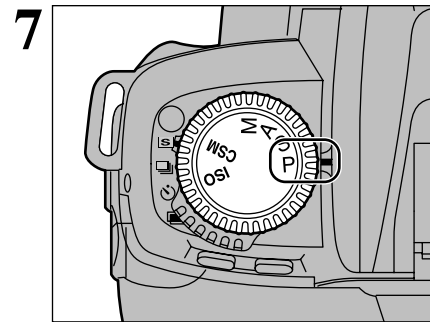

7 Set the exposure mode select dial to “P” (Auto-Multi Program).

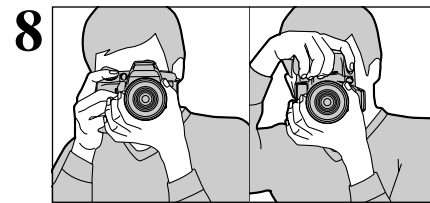

8 Brace your elbows against your body and hold the camera with both hands.

Take care not to obscure the lens with your fingers or the shoulder strap.



9 Position the central focus area over the subject.

If the subject is not inside the AF frame, move the focus area or take the picture using AF lock (P.33).



## TAKING PICTURES



Press the shutter button down halfway to focus the shot. The “●” focus indicator appears in the viewfinder display.

⚠ If the focus indicator is flashing, the camera cannot focus and the shutter will not release.

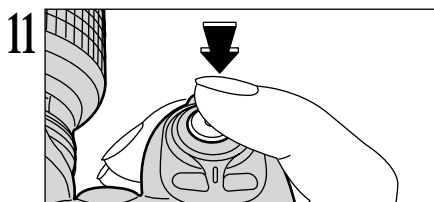

Without releasing the shutter button, press it down all the way (fully pressed) to take the shot.

## NUMBER OF AVAILABLE SHOTS

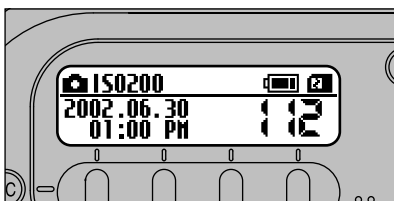

The number of available shots is displayed on the rear display panel.

⚠ See P.73 for information on changing the number of recorded pixels/Quality (compression ratio) setting.  
⚠ The factory default settings set at shipment are 3024 (Number of recorded pixels) and N (Quality: normal).

## Standard Number of Shots for the Media

Because the amount of data needed to record an image varies slightly depending on the type of subject, the number of available shots may not decrease after an image is recorded, or may decrease by 2 in some cases. Also, the difference between the standard number of shots and the actual number of available shots increases for media with a higher capacity.

Number of recorded pixels	4256 4256 × 2848				3024 3024 × 2016			2304 2304 × 1536			1440 1440 × 960		
	HIGH TIFF-RGB	FINE CCD-RAW	NORMAL		HIGH TIFF-RGB	FINE	NORMAL	HIGH TIFF-RGB	FINE	NORMAL	HIGH TIFF-RGB	FINE	NORMAL
Image File Size	Approx. 35.5MB	Approx. 12.4MB	Approx. 4.7MB	Approx. 2.2MB	Approx. 17.9MB	Approx. 2.3MB	Approx. 1.1MB	Approx. 10.4MB	Approx. 1.3MB	Approx. 660KB	Approx. 4.1MB	Approx. 690KB	Approx. 350KB
MG-16S (16MB)	0	1	3	6	0	6	13	1	10	23	3	22	44
MG-32S (32MB)	0	2	6	13	1	12	27	3	22	47	7	45	89
MG-64S (64MB)	1	4	13	28	3	26	55	6	45	94	15	92	180
MG-128S (128MB)	3	9	26	56	7	52	112	12	90	189	30	185	362
Microdrive 340MB	9	26	73	156	19	145	307	33	249	525	84	507	992
Microdrive 1GB	29	80	220	468	58	437	912	100	746	1564	254	1492	2986

\* Number of available shots for formatted media.

## USING AF LOCK



If you take a shot with this type of composition using Single-area AF with the focus area in the center, the subjects (the two people in this case) are outside the focus area and will not be in focus.

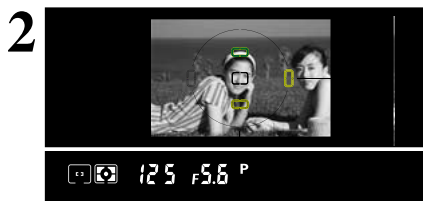

Move the camera slightly so that one of the subjects is in the AF frame.

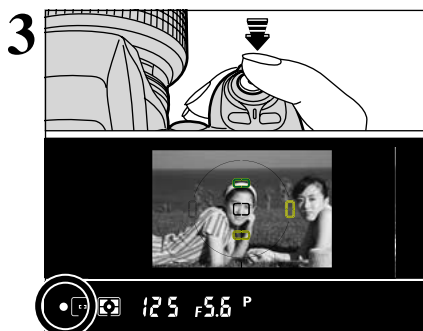

Keep the shutter button pressed down halfway (AF lock) and check that the “●” focus indicator is lit in the viewfinder display.

⚠ If you are using the “AF-C” focus mode, hold the shutter button down halfway and press the “AE-L/AF-L” button (→P.53).



Continue to hold the shutter button down halfway (AF lock). Move the camera back to the original image and then fully press down on the shutter button.

⚠ You can reapply the AF lock as many times as you like before releasing the shutter.  
⚠ The AF lock operates in all photography modes and can be used to ensure excellent results.

## When AF (Auto Focus) does not focus the shot

- Position the focus area over another subject at roughly the same distance and press the shutter button down halfway. Then recompose the shot and take the picture.
- You can also set the focus and take the shot by selecting “M” (manual) as the focus mode.

## PLAYING BACK IMAGES

Press the “**PLAY**” button to play back your images.

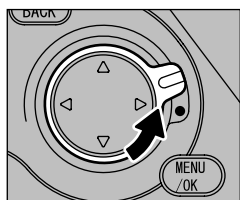
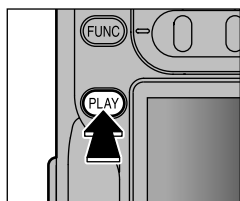

Unlock the 4-direction button to use it.

When you have finished viewing the images...

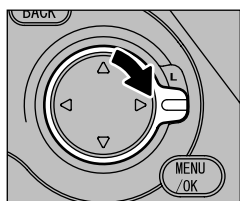

Lock the 4-direction button to prevent accidental improper use.

### Frame advance/rewind



Press “◀” or “▶” to move backwards and forwards through the images. Hold the button down for about 1 second to move quickly through the images.

Images appear slightly coarser during fast forwarding.

### Zoom



Use “▲” or “▼” to zoom in or out.



Switches between zooming and repositioning.

### Panning



Press “◀”, “▶”, “▲” or “▼” to view a different area.

Press “BACK” to return to frame advance mode.

To take a shot when you are viewing images, press the “**PLAY**” button or press the shutter button down halfway.

## DIOPTRE ADJUSTMENT/LCD ILLUMINATOR

### DIOPTRE ADJUSTMENT

The finder dioptre enables near- or far-sighted photographers to adjust the eyepiece dioptre to suit their vision.

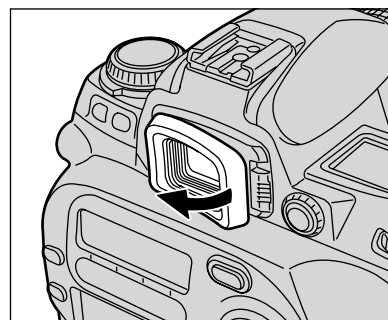

Remove the rubber eyecup.

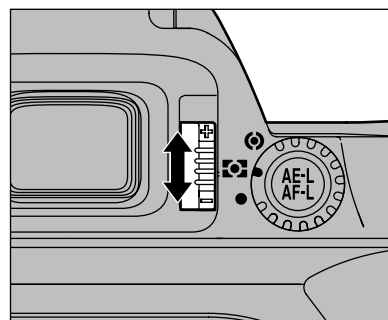

While looking through the viewfinder, adjust the position of the diopter adjustment knob until the focusing frame or the image in the viewfinder appears sharpest. Then reattach the rubber eyecup.

- The diopter setting can be adjusted from  $-1.8 \text{ m}^{-1}$  (shortsighted) to  $+0.8 \text{ m}^{-1}$  (farsighted). Nikon also provides 9 types of diopter adjustment lens ranging from  $-5 \text{ m}^{-1}$  to  $+3 \text{ m}^{-1}$ .

Since the dioptre adjustment lever is located next to the viewfinder, be careful not to poke yourself in the eye with your finger or fingernail while sliding the lever.

### LCD ILLUMINATOR

Displays in the top display panel can be confirmed in the dark with the LCD illuminator.

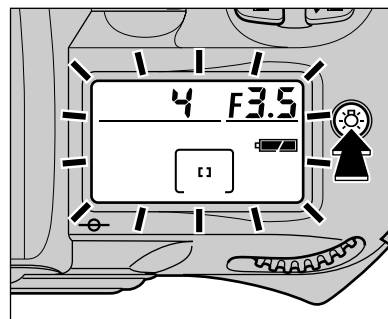

When you press the “**ILLUMINATOR**” LCD illuminator button, the top and rear display panels light up.

- Display panel illumination switches off in the following situations:
  - When you press the “**ILLUMINATOR**” LCD illumination button again
  - When you release the shutter
  - When the Auto Power Off function switches the camera off

Pressing the shutter button down halfway temporarily switches display panel illumination off.

CMS 14: The illuminator can be set to come on when any button is pressed (→P.98).

## DEPTH OF FIELD CHECK BUTTON/CCD PLANE INDICATOR

### DEPTH OF FIELD CHECK BUTTON

Depress the depth-of-field check button to confirm the depth of field through the viewfinder.

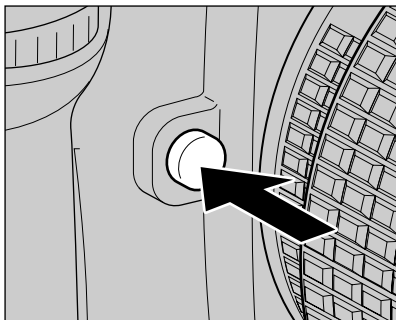

Pressing the depth-of-field check button stops the lens down to the aperture controlled in “P” Auto-Multi Program or “S” Shutter-Priority Auto exposure mode, and down to the aperture selected in “A” Aperture-Priority Auto or “M” Manual exposure mode. By looking through the viewfinder, the approximate depth of field with the given aperture can be confirmed.

When you press the depth of field check button, the shutter speed display and LCD illumination both turn off.

### CCD PLANE INDICATOR

The CCD plane indicator shows the position of the CCD plane inside the camera body.

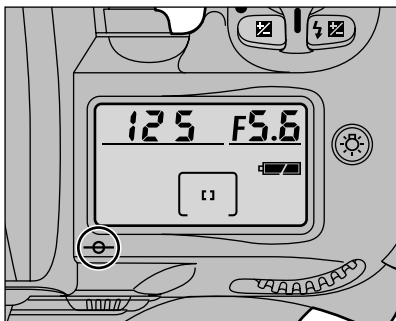

The CCD plane indicator shows the standard line of the shooting distance and indicates the position of the CCD plane inside the camera body. Use this indicator when actually measuring camera-to-subject distance, e.g. in close-up photography. The exact distance from the lens mounting flange to the CCD plane is 46.5 mm.

Pages 38 to 43 provide explanations of how to use and set the camera's focusing functions, along with various related topics. The diagram below is a page map to this section. Refer to the pages indicated for details.

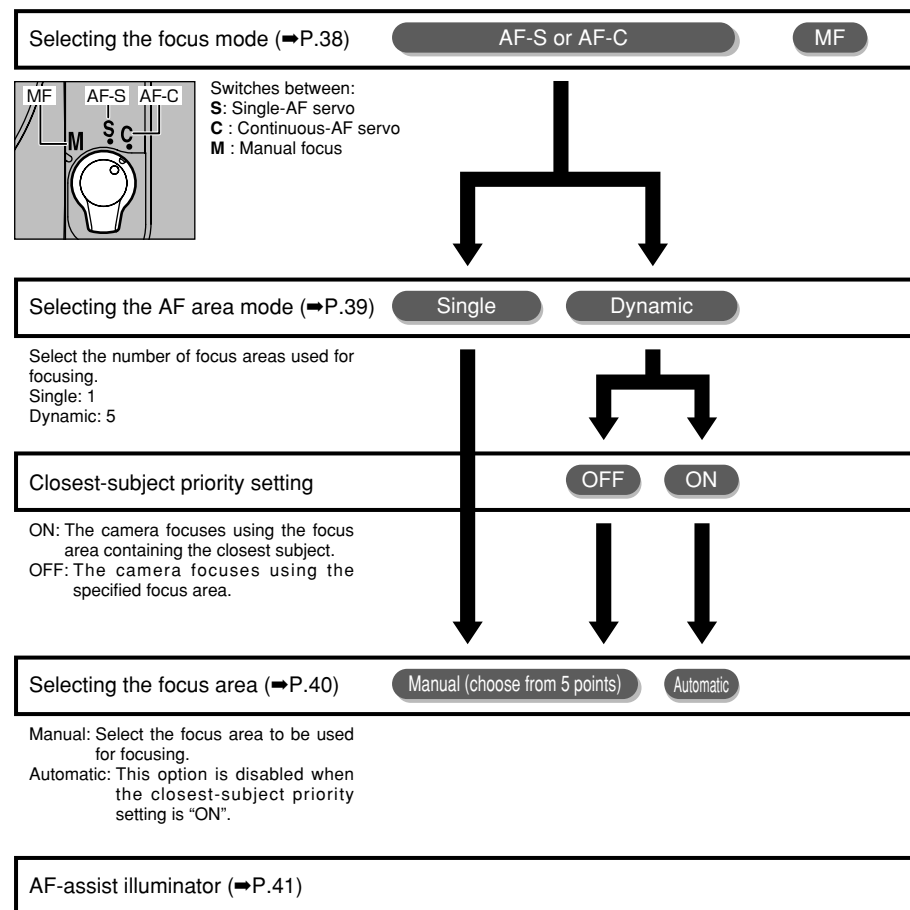

### ■ Focus-related custom settings

<b>CSM 3:</b> Illumination for focus area	Sets the automatic illumination setting for the focus area in the viewfinder	⇒P.97
<b>CSM 4:</b> Focus area selection	Sets the focus area selection method	⇒P.97
<b>CSM 7:</b> Closest-subject priority dynamic AF at S-AF mode	Closest-subject priority dynamic AF settings	⇒P.97
<b>CSM 8:</b> Closest-subject priority dynamic AF at C-AF mode	Sets the closest-subject priority dynamic AF settings	⇒P.97
<b>CSM 9:</b> AE/AF lock button	Selects AE/AF concurrent locking, independent locking, or maintained locking	⇒P.97
<b>CSM 15:</b> AF-assist illuminator	Switches auxiliary AF light ON/OFF	⇒P.98

## FOCUS SETTINGS

### SELECTING THE FOCUS MODE

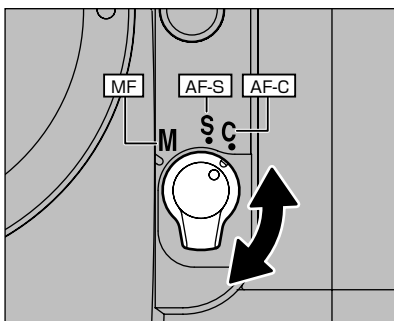

Use the focus mode selector switch to select the focus mode.

#### Focus modes

	AF-S (S: Single AF servo)	AF-C (C: Continuous AF servo)	MF (M: Manual focus)
Features	Focus priority mode. The shutter will only release if the "●" focus indicator is displayed. (Excludes predictive motion focusing)	Release priority mode. The shutter will release even if the "●" focus indicator is not displayed.	Allows you to release the shutter at any time.
AF starts	When the shutter button is pressed down halfway (default).	When the shutter button is pressed down halfway (default).	AF is not used.
Focus lock	When the shutter button is held down halfway and the "●" focus indicator is displayed, the focus is locked.	Even when the shutter button is held down halfway and the "●" focus indicator is displayed, the focus is not locked and focusing continues. Press the AE-L/AF-L button to lock the focus.	The focus is not locked.
Predictive motion focusing (focus tracking function for moving subjects)	Only works for moving subjects from the time AF operation starts. While this function is operating, the camera decides when the subject is in focus and releases the shutter.	Also works for subjects that start moving during shooting.	Does not operate.

**CSM 9:** AF operation can be modified so that it does not begin when the shutter button is pressed down halfway, but when the "AE-L/AF-L" button is pressed (⇒P.97).

You can change the focusing method used for automatic focusing (when the focus mode switch is set to "S" or "C").

### SELECTING THE AF AREA MODE

Single-area AF	<ul style="list-style-type: none"> <li>Focuses using the selected focus area.</li> <li>Useful for situations where you want to focus accurately on a more or less stationary subject.</li> </ul>
Dynamic AF	<ul style="list-style-type: none"> <li>If the subject is outside the specified focus area, another focus area is used for focusing.</li> <li>Useful for shots where it is difficult to accurately keep the subject in a given focus area, such as when you are tracking a moving subject (particularly one that moves in unpredictable ways).</li> </ul>
Closest-subject Priority AF	<ul style="list-style-type: none"> <li>Focuses using the focus area containing the subject closest to the camera.</li> </ul>

\* If spot metering is used in Closest-subject Priority AF mode, metering is always performed for the focus area in the center of the shot.

\* When you are using a telephoto lens or the subject is dark, the closest focus area may not be selected.

**CSM 7/8:** The focus mode determines whether Closest-subject Priority AF is ON or OFF. The default settings are "ON" in "S" (Single-AF servo) mode and "OFF" in "C" (Continuous-AF servo) mode. You can change these settings using the custom settings (⇒P.97).

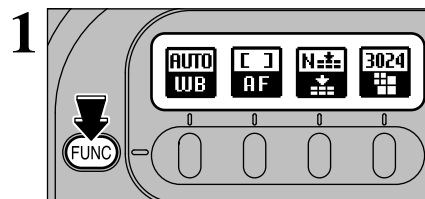

Press the "FUNC" button to display this screen.

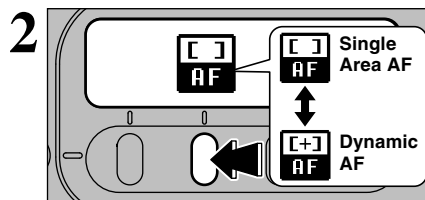

Select Single-area AF or Dynamic AF.

**The displays shown in the viewfinder and on the top display panel are shown below.**

	Single-area AF	Dynamic AF (Closest-subject Priority AF OFF)	Dynamic AF (Closest-subject Priority AF ON)
Focus area			
Top display panel/viewfinder display			

Then specify the focus area.

End of settings. 39

## FOCUS SETTINGS

### Selecting the focus area

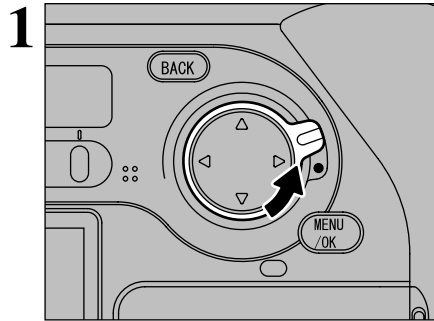

Unlock the 4-direction button.

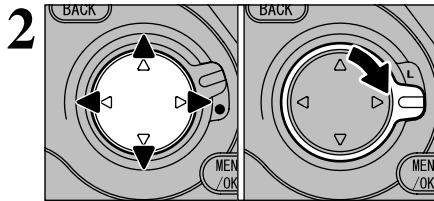

Press “◀”, “▶”, “▲” or “▼” to select the focus area. Once you have specified the focus area, lock the 4-direction button to prevent accidental improper use.

- The specified focus area is automatically illuminated in red according to the brightness of the subject.

**CSM 3:** The specified focus area is automatically illuminated, but you can change the settings so that the illumination is disabled or is no longer dependent on the subject brightness (⇒P.97).

**CSM 4:** Normally, you can only select a focus area by pressing the arrow on the 4-direction button that points towards that focus area. However, you can set camera operation so that when the right-hand focus area is selected, pressing “▶” on the 4-direction button selects the left-hand focus area. This means you can switch between focus areas on opposite sides without having to press different sides of the 4-direction button (⇒P.97).

## AF-ASSIST ILLUMINATOR

When the subject is dark and the shutter release button is pressed lightly, the camera's AF-Assist Illuminator automatically turns on and enables autofocus operation in a dark environment.

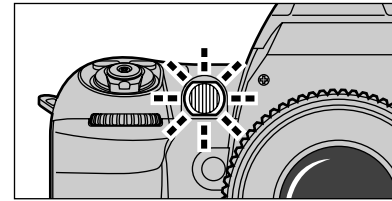

AF-Assist Illuminator automatically turns on in the following situations:

Focus mode is Single Servo AF, AF Nikkor lens is used, subject is dark and centre focus area is selected or Dynamic AF Mode with Closest Subject Priority is activated.

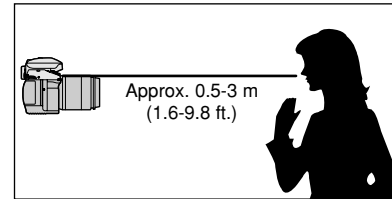

Focal length of the usable AF Nikkor lens is 24-200 mm and the distance range of the AF-Assist Illuminator is approx. 0.5-3 m (1.6-9.8 ft.).

**CMS 15:** AF-Assist Illuminator can be cancelled (⇒P.98).

When the AF-Assist Illuminator is used continuously, illumination is limited temporarily to protect the firing tube. The illumination restarts after a few moments. Also, when the AF-Assist Illuminator is used repeatedly in a short period of time, be careful not to touch the AF-Assist Illuminator lamp because it may have become hot.

### ◆ Nikon flash units and active auxiliary flash ◆

If you use an SB-28/28DX, SB-27, SB-26, SB-25 or SB-24 Nikon flash to take pictures when the conditions for active assist illuminator are met, the active assist illuminator on the Nikon flash automatically fires. With other Nikon flash models, the AF-assist illuminator on the camera automatically lights.

### ◆ Lenses For Which Vignetting Occurs ◆

- Autofocus using the camera's AF-Assist Illuminator cannot be performed due to vignetting with following lenses at shooting distance within 1m:
  - AF Micro 200 mm f/4 IF-ED
  - AF-S 17-35 mm f/2.8 IF-ED
  - AF 18-35 mm f/3.5-4.5 ED
  - AF 20-35 mm f/2.8 IF
  - AF 24-85 mm f/2.8-4
  - AF 24-120 mm f/3.5-5.6 IF
  - AF-S 28-70 mm f/2.8 IF-ED
  - AF Micro 70-180 mm f/4.5-5.6 ED
- Autofocus using the camera's AF-Assist Illuminator cannot be performed due to vignetting with AF-S 80-200 mm f/2.8 IF-ED, AF 80-200 mm f/2.8 ED and AF VR 80-400 mm f/4.5-5.6 ED.

## SITUATIONS WHERE AUTOFOCUS MAY NOT WORK AS EXPECTED

Autofocus may not work as expected in the following situations. In such situations, focus manually using the clear matte field or focus on a different subject located at the same distance, use AF lock (➔P.33) then recompose.

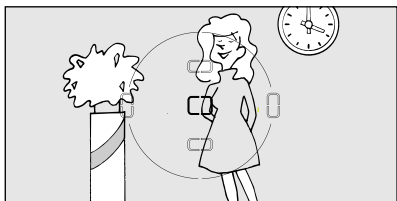

**Low-contrast scenes**  
For example, where the subject is wearing clothing the same colour as a wall or other background.



**Scenes with subjects within the focus brackets located at different distances from the camera**  
For example, when shooting an animal in a cage or a person in a forest.

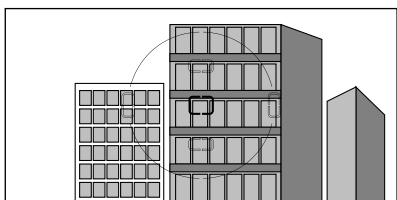

**Patterned subject or scene**  
For example, building windows.

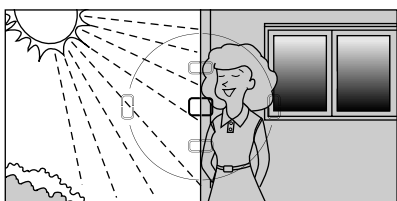

**Scenes with pronounced differences in brightness within the focus brackets**  
For example, when the sun is in the background and the main subject is in shadow.

## MANUAL FOCUS

Use Manual focus in situations where autofocus may not work as expected (➔P.42) or a lens other than an AF Nikkor lens (➔P.19) is attached.

### Focus can be set manually when the focus mode selector is set to M.

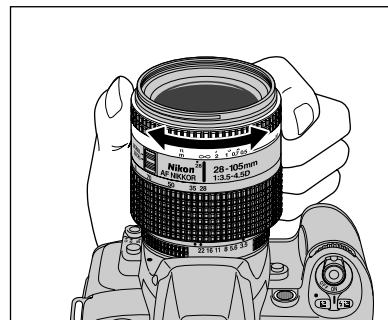

Focus the camera by turning the focusing ring on the lens until the image can be seen clearly in the matt surface of the viewfinder screen.

- When using a lens with the A-M select function, set the switch/ring to "M" to focus manually. If "M/A" (autofocus with manual priority) is available with your lens, Manual focus is possible either with the switch/ring set to "M" or "M/A". See the instruction manual of your lens for details.

### Focus Aid



This allows you to check the focus of your shot using the focus indicator "●" in the viewfinder. You can use Focus Aid when the lens mounted has an f-stop setting brighter than f/5.6.

- ① Position the selected focus area over the object on which you want to focus.
- ② Turn the focusing ring on the lens.

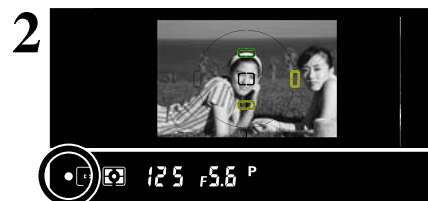

Press the shutter button down halfway. When the shot is in focus, the focus indicator "●" lights.

#### ◆ Focus indicator ◆

To make focusing easier on this camera, the range in which the focus indicator "●" lights is set to a fixed size. As a result, the camera does not react to slight movements of the focusing ring, thereby avoiding flickering in the focus indicator "●".

However, this means that the focusing position at the wide-angle setting is very slightly different from the focusing position at the telephoto setting, so that the shot may not be optimally focused even when the focus indicator "●" is lit. In this situation, you can focus precisely by positioning the focusing ring in the middle of the range in which the focus indicator "●" lights.

## RELEASE MODES/ (SINGLE-FRAME) AND (CONTINUOUS SHOOTING)

The release mode is normally set to Single-frame. Set the release mode to Continuous Shooting to take sequential shots of moving subjects or to take a series of shots using Auto Exposure Bracketting.

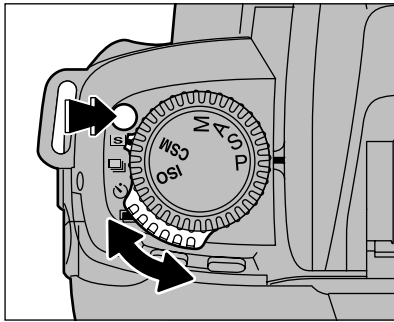

Hold down the release mode switch unlock button and set the release mode switch to “S” (Single frame) or “C” (Continuous Shooting).

### (Single frame)

In this mode, one shot is taken each time you press the shutter button. Use this mode to take a single clearly defined shot in each frame.

⚠ If you take a number of single-frame shots in rapid succession, the number of available shots is highlighted in the same way as in continuous shooting. Once this happens, no further shots can be taken. Wait until the number of available shots is no longer highlighted.

### (Continuous Shooting)

This mode allows you to take up to 7 consecutive shots at intervals as short as 0.5 seconds by holding down the shutter button.

● Once you have shot the maximum number of continuous frames (7), the number of available shots shown on the rear display panel is highlighted. No further continuous shots can be taken at that point. Wait until the number of available shots is no longer highlighted.

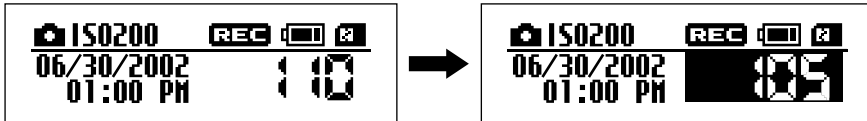

- ⚠ The continuous shooting speed is fixed and does not vary according to the resolution or quality settings.
- ⚠ You cannot use continuous shooting with the built-in flash.
- ⚠ If previewing is selected for photographed images (P.90) when continuous shooting is used, only the photographed image for the final frame is displayed and automatically recorded.
- ⚠ If you use continuous shooting when the number of available shots is low, the number of available shots may temporarily change to 0.

## METERING SYSTEMS

Normally, the Matrix Metering system will provide the optimum exposure for your shot. However, you can choose from 3 metering modes for shots where you want to select a different exposure level (AE lock or exposure compensation) or for particular scenes (such as backlit shots or shots with very strong contrast).

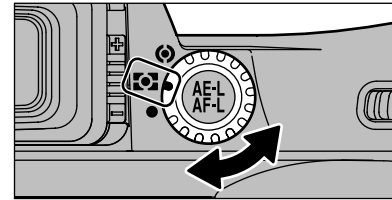

Turn the metering system selector dial to desired metering system. The icon for the selected metering system appears in the viewfinder.

### : Matrix (10-segment) metering

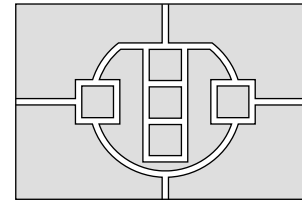

The camera sets the optimum exposure based on data (the maximum brightness and brightness contrast) measured independently for 10 segments in the photography screen. With D- or G-type Nikkor lenses, 10-segment 3-D matrix metering is used, factoring in the distance to the subject as well as the maximum brightness and brightness contrast to ensure even more accurate metering.



### : Center-weighted metering

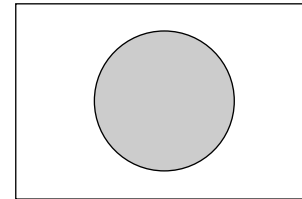

Center-weighted metering determines the exposure value based primarily on a 12-mm circle in the center of the viewfinder.

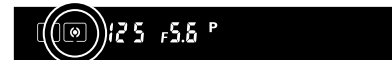

### : Spot metering

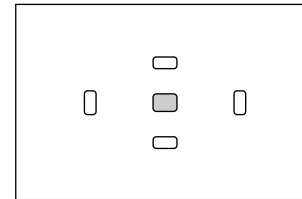

Spot metering determines the exposure value by concentrating metering on the equivalent of a 4-mm diameter area in the viewfinder (approx. 2% of the entire frame).

The metering area moves to follow shifts in the selected focus area. However, spot metering always remains in the center of the shot when Closest-subject Priority Dynamic AF mode is used.



# ISO SENSITIVITY/EXPOSURE MODES P

## ISO SENSITIVITY

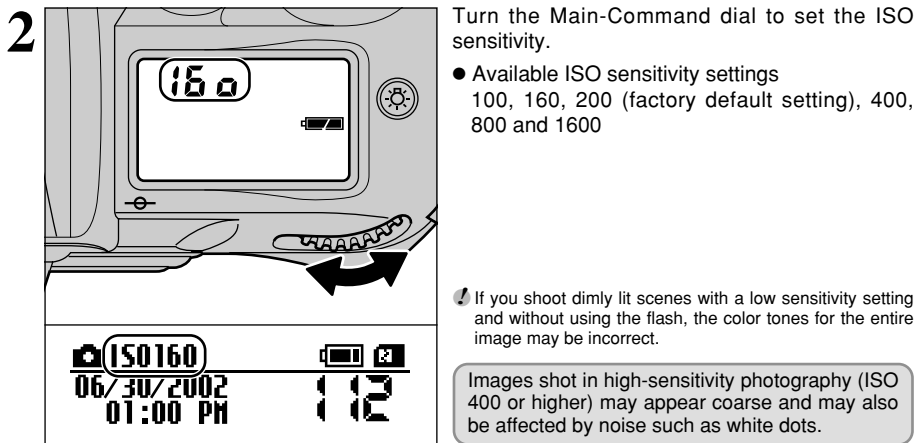
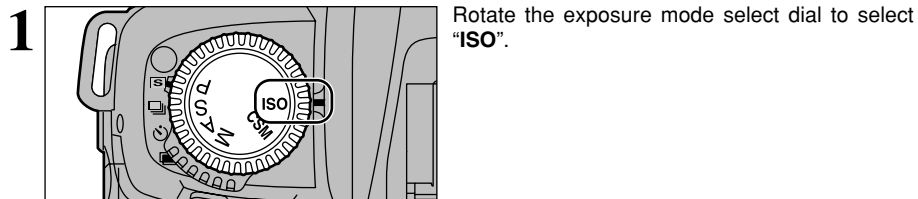

## P MULTI-PROGRAMMED AUTO

This mode automatically controls the shutter speed and aperture setting to give the optimum exposure for the photography conditions. This mode is useful when you want to be able to take pictures quickly and easily to take advantage of snapshot opportunities.

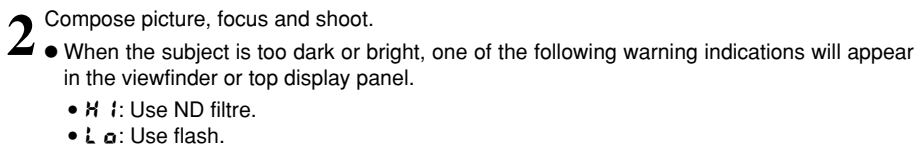
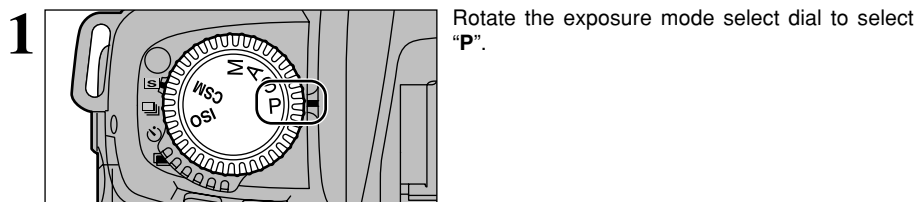

## Flexible Program

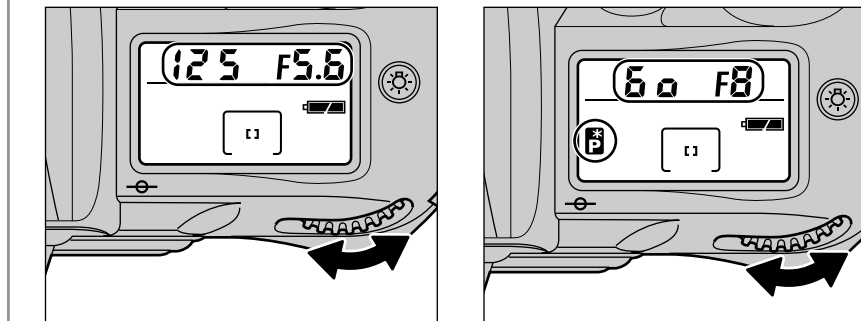

In Auto-Multi Program, by rotating the Main-Command dial you can change the combination of shutter speed and aperture while maintaining correct exposure. With this function, you can shoot in Auto-Multi Program as though you were shooting in Shutter-Priority Auto or Aperture-Priority Auto. **F** appears in the top display panel when the Flexible Program is used. To cancel the Flexible Program, turn the Main-Command dial until the Flexible Program icon **F** disappears, change the exposure mode, turn the power switch to "OFF", use the built-in flash (→P.64), or perform a Two-Button Reset (→P.95).

## Program chart

The program chart shows exposure control in Auto-Multi Program exposure mode (ISO 100).

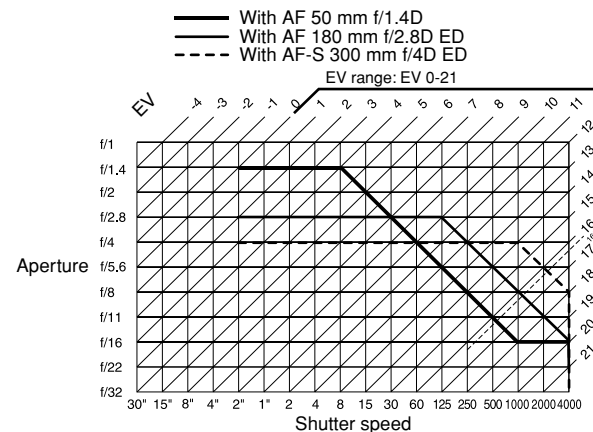

- Limits apply to the upper and lower EV values depending on the metering range for the sensitivity setting.
- In Matrix Metering, any EV above 16 1/3 is controlled to EV 16 1/3 when using ISO 100. Consequently, shots of very bright subjects may be overexposed.

If you select the "P", "S" or "A" exposure mode when you are not using a Nikkor lens with a built-in CPU, "F- -" appears on the top display panel and in the viewfinder and you cannot take pictures. When this occurs, you can take pictures by setting the exposure mode to "M" and using the aperture ring on the lens to set the aperture. Note that you cannot use the camera's exposure meter.



## EXPOSURE MODES S

### S SHUTTER-PRIORITY AUTO

In this mode, the photographer sets the shutter speed (1/4000 to 30 sec.) and the camera automatically controls the aperture setting. This mode is best when the shutter speed takes priority, such as shots where a fast shutter speed is used to freeze the action or a slow shutter speed is used to convey the sense of movement.

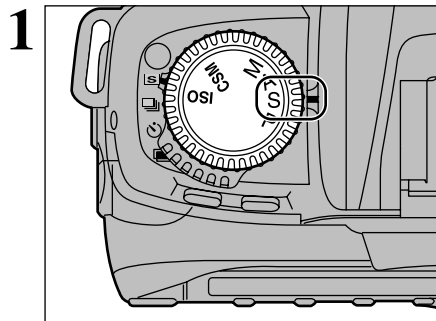

1 Rotate the exposure mode select dial to select "S".

- If "bulb" is selected in "M Manual" exposure mode and the exposure mode is changed to Shutter-Priority Auto without cancelling "bulb", "bulb" blinks and the shutter locks. When this occurs, select a shutter speed other than "bulb".

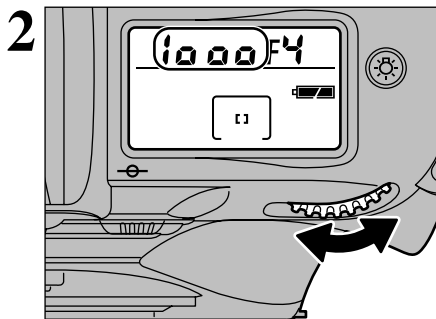

2 Set the shutter speed (1/4000 to 30 sec.) on the main command dial.

Images shot with long exposures (1 second or longer) may appear coarse and may also be affected by noise such as white dots.

3 Compose picture, focus and shoot.

- When the subject is too dark or bright, one of the following warning indications will appear in the top display panel or viewfinder (Electronic analog exposure display will also indicate the amount of under- or overexposure).

- **H f**: Select higher shutter speed. If the warning indication still remains on, use ND filtre.
- **L α**: Select a slower shutter speed. If the warning indication still remains on, use the flash.

- For long exposures, it takes several seconds for the Access lamp to light after the image shown in the preview window has disappeared.

If you select the "P", "S" or "A" exposure mode when you are not using a Nikkor lens with a built-in CPU, "F- -" appears on the top display panel and in the viewfinder and you cannot take pictures. When this occurs, you can take pictures by setting the exposure mode to "M" and using the aperture ring on the lens to set the aperture. Note that you cannot use the camera's exposure meter.

## EXPOSURE MODES A

### A APERTURE-PRIORITY AUTO

In this mode, the photographer sets the aperture (narrowest aperture to widest aperture) and the camera automatically controls the shutter speed. This mode is best for photographs where the priority is on the depth of field (the area where objects are in focus), such as shots where both near and distant objects are in clear focus (narrowest apertures) or where the background is out of focus (widest apertures).

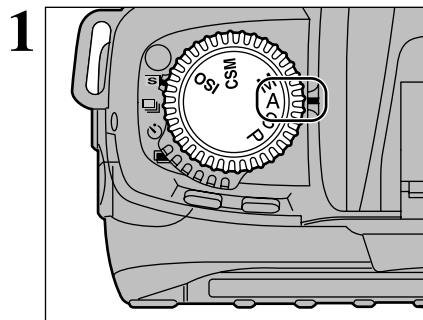

1 Rotate the exposure mode select dial to select "A".

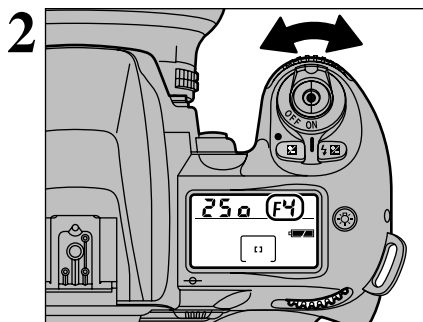

2 Use the sub-command dial to set the aperture (narrowest aperture to widest aperture).

3 Compose picture, focus and shoot.

- When the subject is too dark or too bright, one of the following warnings will appear in the top display panel or viewfinder (Electronic analog exposure display will also indicate the amount of under- or overexposure).

- **H f**: Select smaller aperture (larger f-number). If the warning indication persists, use an ND filtre.
- **L α**: Select larger aperture (smaller f-number). If the warning indication persists, use the flash.

If you select the "P", "S" or "A" exposure mode when you are not using a Nikkor lens with a built-in CPU, "F- -" appears on the top display panel and in the viewfinder and you cannot take pictures. When this occurs, you can take pictures by setting the exposure mode to "M" and using the aperture ring on the lens to set the aperture. Note that you cannot use the camera's exposure meter.

# EXPOSURE MODES M

## M MANUAL

In this mode, the photographer is free to set any shutter speed (1/4000 to 30 sec. or “b u l b”) or aperture setting (narrowest aperture to widest aperture). This allows the photographer to determine the exposure to suit the conditions and the desired effect while watching the exposure indicator in the viewfinder.

**CSM 6:** To use the “b u l b” shutter speed (for long exposures), the custom settings must be modified (➔P.97).

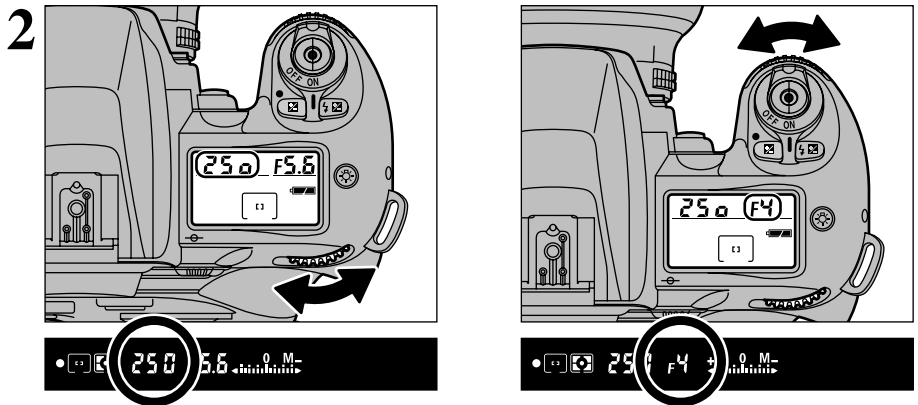
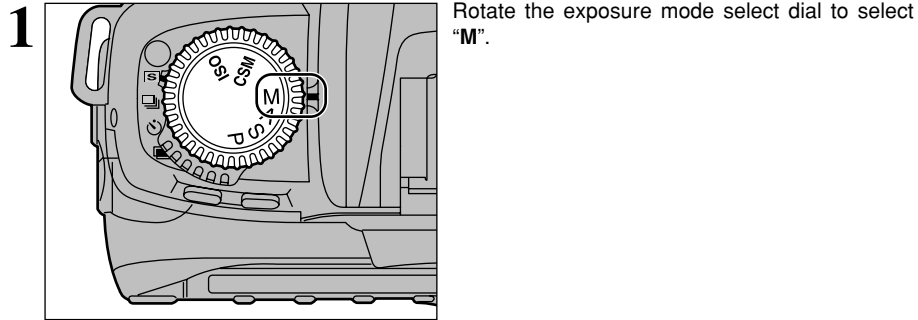

While watching the exposure indicator in the viewfinder, use the main command dial to set the shutter speed (1/4000 to 30 sec. or “b u l b”) and the sub-command dial to set the aperture setting (narrowest aperture to widest aperture).

- When the exposure compensation (➔P.54) is set, only the electronic analog display changes—selected shutter speed and aperture do not change.

Images shot with long exposures (1 second or longer) may appear coarse and may also be affected by noise such as white dots.

## ◆ Electronic analog exposure display ◆

The electronic analog display in the viewfinder indicates the difference between the selected exposure (shutter speed and aperture) and the correct exposure. Not available with Long Time Exposure.

The electronic analog exposure display blinks when the subject brightness is beyond the camera’s exposure range.

The following examples show electronic analog exposure display indications:

Correct exposure	-1/2 EV	Over +3 EV
+...0...-	+...0...-	+...0...-

3 Compose picture, focus and shoot.

If you are not using a Nikkor lens with a built-in CPU, you can take pictures by using the aperture ring on the lens to set the aperture. However, you cannot use the camera’s exposure meter. “F- -” also appears on the top display panel and in the viewfinder.

## Bulb Photography (“bulb”)

Bulb photography is useful when you want to take pictures with any shutter speed. You should use a tripod to keep the camera steady because the shutter stays open for as long as the shutter button is held down.

Images shot with long exposures (1 second or longer) may appear coarse and may also be affected by noise such as white dots.

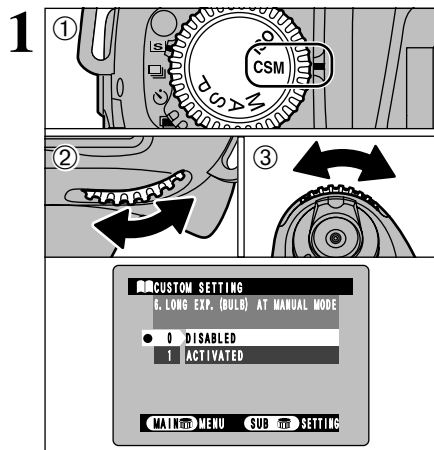

**CSM 6:** To use the “bulb” shutter speed (for long exposures), the custom settings must be modified (⇒P.97).

- ① Set the exposure mode dial to “CSM”.
- ② Use the main command dial to select “6. LONG EXP. (BULB) AT MANUAL MODE”.
- ③ Use the sub-command dial to select “1: ACTIVATED”.

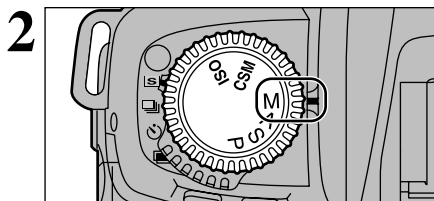

Set the exposure mode dial to “M”.

- Bulb photography can only be used in Manual exposure mode.
- A tripod should be used for bulb photography.

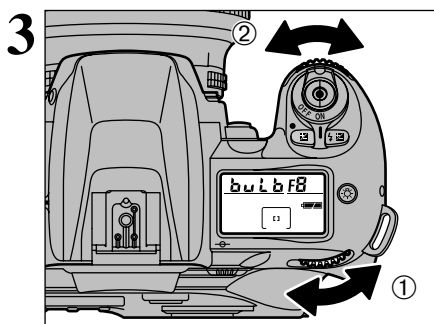

- ① Use the main command dial to set the shutter speed to “bulb” and then ② use the sub-command dial to set the aperture setting (narrowest aperture to widest aperture).

4 Compose picture, focus and shoot.

- The shutter will be open as long as the shutter release button is kept fully depressed.
- Using the cable release (sold separately) attached to the release terminal instead of pressing the shutter button with your finger also reduces camera shake.

AE lock allows you to set the exposure for a specific subject in your shot. This technique is useful when brightness of your subject differs greatly from its surroundings.

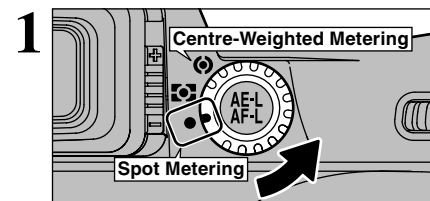

1 Rotate the metering system selector to select Centre-Weighted or Spot Metering.

- Matrix Metering is not recommended since the effect of the Auto Exposure Lock cannot be effectively attained.

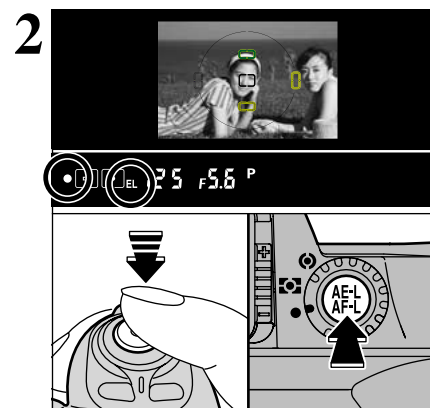

2 Position the focus area over the subject you want correctly exposed, press and hold the shutter button down halfway and then press the “AE-L/AF-L” button. The “EL” (exposure lock) indicator appears in the viewfinder.

- The exposure and focus are locked as long as the “AE-L/AF-L” button is held down (default setting).
- If you press the “AE-L/AF-L” button in the AF-S or AF-C focus mode when the shot is not in focus, the exposure is locked with the shot out of focus. Always check that the “●” focus indicator is lit.

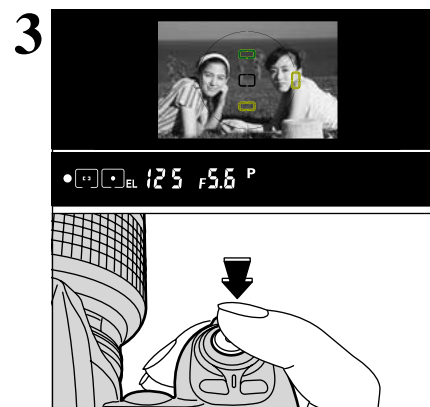

3 While keeping the “AE-L/AF-L” button pressed, recompose, focus and shoot.

- Because the settings are maintained after you take the shot for as long as the “AE-L/AF-L” button is held down, you can keep the same settings as you recompose the shot.
- The following functions can be operated while the “AE-L/AF-L” button is kept pressed:
  1. In “P” exposure mode: Sets program shift.
  2. In “S” exposure mode: Changes the shutter speed.
  3. In “A” exposure mode: Changes the aperture.
- Rotating the metering system selector to another setting does not change the metering system during Auto Exposure Lock operation. Release the AE lock.

**CSM 5:** Auto Exposure Lock can be set to be activated by lightly pressing the shutter release button (⇒P.97).

**CSM 9:** The operation performed when the “AE-L/AF-L” button is pressed can be modified (⇒P.97).

Operation: AF/AE lock (default setting), AE lock only, AF lock only, AE lock maintained, AF operation

## EXPOSURE COMPENSATION

Exposure compensation allows you to intentionally vary the optimum exposure value controlled by the camera. This can be useful when intentionally achieving under- or overexposure. Use Centre-Weighted or Spot Metering. Exposure compensation can be performed in any exposure mode (However in “M” exposure mode, only the electronic analog display changes—selected shutter speed and aperture do not change).

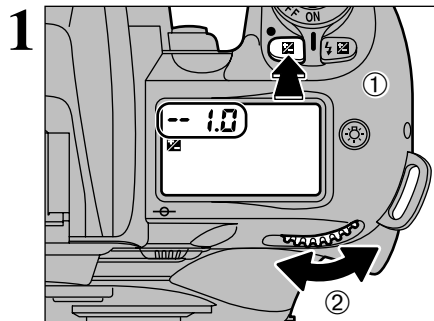

1 Set exposure compensation by rotating the Main-Command Dial while pressing the “**EC**” button until the desired compensation value appears (–3 EV to +3 EV in 1/2 EV steps).

- When the exposure compensation is set, “**EC**” appears on the top display panel and viewfinder. The Electronic analog exposure display also appears in the viewfinder. The compensation value can be checked by pressing the “**EC**” button.
- Electronic analog exposure display indicates the exposure compensation value and “0” blinks.
- Normally, you should compensate exposure to the + side when the background is brighter than your main subject, or to the – side when the background is darker.
- See p.67 for information on using flash exposure compensation to adjust the amount of light emitted by the flash.

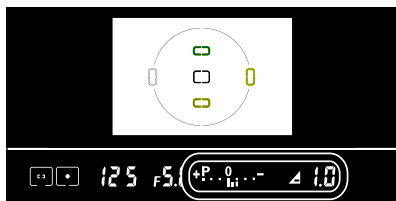

Electronic analog exposure display



–0.5 EV compensation



+2 EV compensation

2 Compose picture, focus and shoot.

- To cancel exposure compensation, set the compensation amount to “0.0” or perform a two-button reset (→P.95). (Switching the camera off does not cancel exposure compensation.)

## BKT AUTO EXPOSURE BRACKETING

Use Auto Exposure Bracketing when you want to take the same shot with different exposure settings. Using the correct exposure setting displayed by the camera (the value set in “M” exposure mode) as a reference, the camera can automatically offset the exposure by a set value (up to ±2 EV steps without exposure compensation) in either direction.

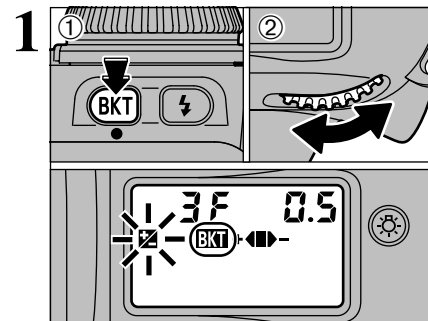

1 Hold down the “**BKT**” (Auto Exposure Bracketing) button ① as you turn main command dial ② to display the “**BKT**” icon on the top display panel.

- The “**EC**” icon continues to flash while auto exposure bracketing is being used to indicate that auto exposure bracketing photography is in progress.

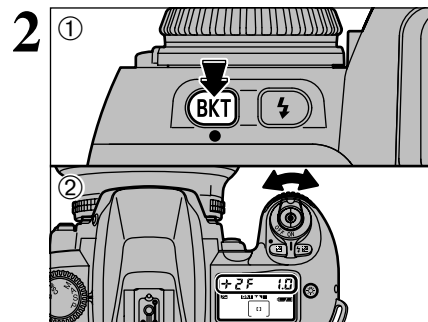

2 Hold down the “**BKT**” (Auto Exposure Bracketing) button ① as you turn sub-command dial ② to set the number of shots (up to 3) and the exposure offset (up to ±2 EV steps in 1/2 EV step increments).



- Check the number of available shots before setting the number of shot.

### List of exposure offsets and numbers of shots

Number of shots and compensated EV value	Bracketing bar graphs	Bracketing order
3F 0.5	+◀▶-	0, –0.5, +0.5
3F 1.0	+◀▶-	0, –1.0, +1.0
3F 1.5	+◀▶-	0, –1.5, +1.5
3F 2.0	+◀▶-	0, –2.0, +2.0
+2F 0.5	+◀	0, +0.5
+2F 1.0	+◀	0, +1.0
+2F 1.5	+◀	0, +1.5
+2F 2.0	+◀	0, +2.0
–2F 0.5	▶-	0, –0.5
–2F 1.0	▶-	0, –1.0
–2F 1.5	▶-	0, –1.5
–2F 2.0	▶-	0, –2.0

## BKT AUTO EXPOSURE BRACKETING

3 Compose picture, focus and shoot. A bracketing bar graph in the top display panel shows the photography status each time a shot is taken.



- When three shots are to be taken, “+◀▶-” is shown before shooting begins, “+◀▶-” appears after the first shot, “+◀” appears after the second shot, and the bar graph disappears when shooting is completed.
- If you hold the shutter button down when the “” (Continuous shooting) release mode is selected, shooting automatically stops when the specified number of shots has been taken. Note that shots are taken one frame at a time when the built-in flash is used.
- If the exposure compensation function (⇒P.54) or flash exposure compensation (⇒P.67) is also set, Bracketing will be combined with the exposure compensation values. It is useful to perform Bracketing with a compensated value of over +2 EV or under -2 EV.
- To cancel the Bracketing, rotate the Main-Command Dial while pressing the “” button so “” disappears from the top display panel or perform Two-Button Reset (⇒P.95). The number of shots and compensated EV values previously selected will remain when they are cancelled with the Main-Command Dial, and they automatically reset to “3F 2.5” when the Two-Button Reset is performed.

CSM1: Bracketing order can be set to change from negative EV value to positive EV value (⇒P.97).

## MULTIPLE EXPOSURE

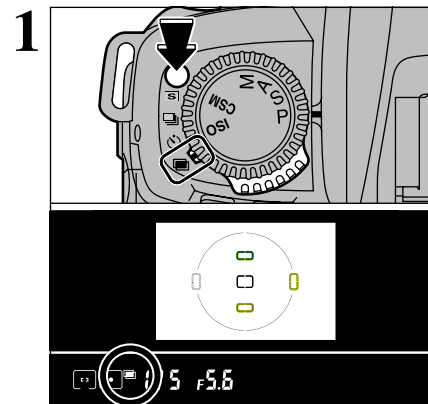
This is a photography technique that allows you overlay photographed images on top of each other. You can use this technique to compose shots that cannot be obtained normally.



1 Hold down the release mode switch unlock button and set the release mode switch to “” (multi-exposure). When you select multi-exposure mode, the “” icon appears in the viewfinder display.

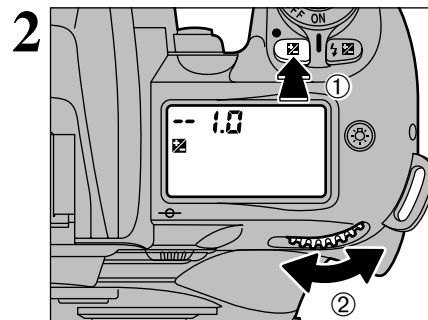

2 According to the photography conditions, hold down the “” (exposure compensation) button ① as you turn the main command dial ② to set the exposure offset.

### ◆ Standard compensation value in Multiple exposure ◆

In multi-exposure, a number of images are shot in the same frame. When you are overlaying backgrounds and subjects, you must set the appropriate exposure offset before taking any shots.

#### ■ General guide to exposure offsets

Number of exposures	Compensation value
Two	-- 1.0
Three	-- 1.5
Four	-- 2.0

- Test shooting is recommended since the compensation actually required varies depending on the shooting situation.
- When the background is completely dark and subjects do not overlap, no compensation is necessary for each shot.

## MULTIPLE EXPOSURE

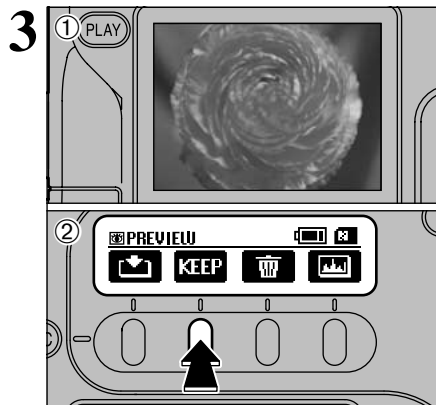

- ① When you compose, focus and take the shot, a preview image appears on the LCD monitor.
  - ② Press "F2" to move on to the next shot.
- A preview image is always displayed, regardless of the "PREVIEW" setting selected in SET-UP.
  - If you change the release mode before multi-exposure shooting is completed, no images are recorded.

You cannot use the function menus or SET-UP to change the camera settings while multi-exposure shooting is in progress.

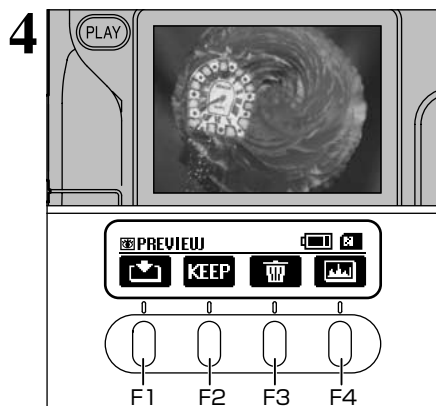

When you take the next (multi-exposure) shot, a preview appears showing the overlaid images.

- To record the image: Press the "F1" or "MENU/OK" button.
- To take another multi-exposure shot: Press the "F2" button.
- To take the shot again without using multi-exposure mode: Press the shutter button again.
- To cancel multi-exposure mode without recording the shots: Press the "F3" or "BACK" button.
- To check the brightness distribution: Press the "F4" button.

⚠ Preview image display is cancelled when the Auto Power Off function operates (after 15 seconds under the default setting). Record preview images before the Auto Power Off function is triggered.

**CSM 11:** In multi-exposure mode, one shot is taken in the frame each time the shutter button is pressed, but continuous shooting can also be used (→P.97).

- ⚠ If you only shoot one frame, multiple exposures cannot be shot because "MULTI" is not displayed. Always take continuous shots.
- ⚠ You cannot use the built-in flash for continuous shooting.

## SELF-TIMER PHOTOGRAPHY

You can use the self-timer when you want to be in the photograph. Use a tripod or place the camera on a stable surface before using the self-timer.

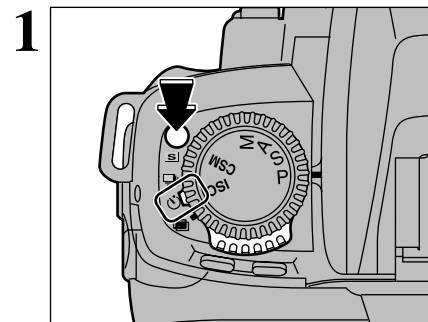

Hold down the release mode switch unlock button and set the release mode switch to Self Timer.

### ◆ Before shooting ◆

- The self timer does not operate in situations where the camera shutter is disabled, such as when the focus is not set in AF-S (Single-AF Servo) mode.
- In exposure modes other than "M" (Manual), you must prevent any back-entry light from the eyepiece to obtain the correct exposure. Before pressing the shutter button, cover the eyepiece with your hand or the eyepiece cap provided. To attach the eyepiece cap, remove the rubber eyecup and slide the cap down over the eyepiece from above.
- Do not stand in front of the lens when setting the self-timer in autofocus mode.

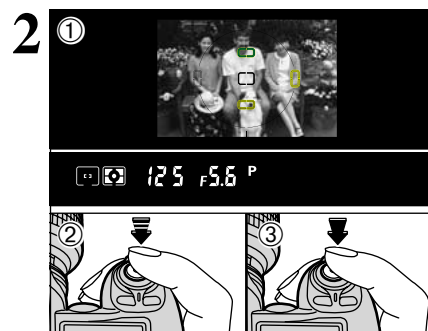

- ① Position the focus area over the subject.
- ② Press the shutter button down halfway to focus the shot.
- ③ Without releasing the shutter button, press the shutter button down fully to start the self timer.

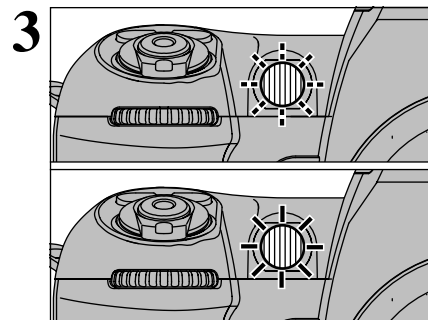

The self timer flashes for 8 seconds and then stays lit for 2 seconds, after which the shot is taken.

- To cancel Self Timer mode, set the power switch to "OFF" or simply move the release mode switch to another setting.
- You can change the self timer running time from 10 seconds to 2, 5 or 20 seconds (→P.98).

# FLASH PHOTOGRAPHY

## SETTINGS FOR FLASH PHOTOGRAPHY

Some flash settings can be set directly:

Synchro mode (the flash timing and shutter speed)  
Flash exposure compensation (flash brightness adjustment)

Other settings are:

Flash control mode (the system for measuring and adjusting the flash brightness)  
Flash control range (the effective range of the flash)

The basic settings for flash photography are explained on pages 61 to 67. If necessary, refer also to “Nikon Flash Units That Can Be Used” (➡P.68).

### ◆ How the flash control mode is set ◆

The three flash modes are 3D-Multi BL, Multi BL and TTL. One of these is selected based on the exposure mode, the metering system and the lens-flash combination.

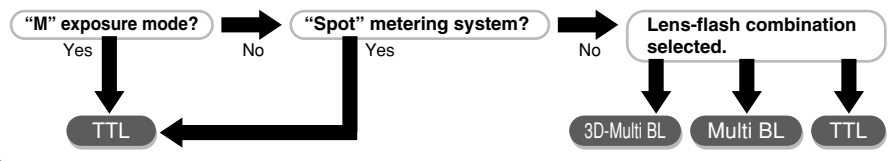

### ◆ To increase the effective range of the flash ◆

Item	Measure
Lens brightness	Use a brighter lens.
Guide No.	Use a higher number.
Aperture	Widen the aperture.
ISO setting	Increase the ISO setting.

# BUILT-IN FLASH

This camera is equipped with a built-in Speedlight that provides an angle of coverage for a 28mm lens with a guide number of 12 (ISO100, m). TTL Auto Flash modes such as 3D Multi-Sensor Balanced Fill-Flash and Multi-Sensor Balanced Fill-Flash are available and ensure proper exposure of the main subject and background, while providing adequate flash output to create natural-looking flash photography. In addition to shooting in dim light, the flash can be used in daylight to reduce shadows on the main subject or to put catchlights in your subject's eyes. Five flash sync modes—Front-Curtain Sync (Normal Sync), Slow Sync, Rear-Curtain Sync, Red-Eye Reduction and Red-Eye Reduction with Slow Sync—are available with this camera.

### ■ Flash control modes that can be used with the built-in flash

Lens	TTL Auto Flash mode
D- or G-type Nikkor lens	3D Multi-Sensor Balanced Fill-Flash*1 (with Distance Information and Monitor Pre-Flash*2)
CPU Nikkor lens other than D/G- type (except AF Nikkor for F3AF)	Multi-Sensor Balanced Fill-Flash*1 (with Monitor Pre-Flash*2)
Non-CPU Nikkor lens	Standard TTL*3

\*1 When built-in flash is used and the exposure mode is set to Manual or Spot metering is selected, TTL Auto Flash mode automatically changes to Standard TTL Flash.

\*2 To cancel Monitor Pre-Flash, select Manual exposure mode or Spot metering.

\*3 Monitor-Pre Flash is not fired in Standard TTL Flash.

### 3D Multi-Sensor Balanced Fill-Flash

3D Multi-Sensor Balanced Fill-Flash can be performed with a combination of the FinePix S2 Pro camera and D- or G-type Nikkor lens. In this flash mode, just after you press the shutter release button and before the shutter is activated, the built-in flash will fire a series of imperceptible pre-flashes that are detected by the FinePix S2 Pro's five-segment TTL Multi Sensor, then analysed for brightness and contrast. Furthermore, it integrates Distance Information from the lens with other exposure control information, automatically compensating the flash output level so that flash output and ambient light are balanced.

3D Multi-Sensor Balanced Fill-Flash enables flash photography in very difficult situations, such as a scene that includes an object with extremely high reflectivity or a subject against an “infinite” background (empty sky, clouds, etc.).

### Multi-Sensor Balanced Fill-Flash

Multi-Sensor Balanced Fill-Flash, without the Distance Information added to the 3D Multi-Sensor Balanced Fill-Flash, can be performed with a combination of the FinePix S2 Pro camera and CPU Nikkor lens other than D/G-type.

3D Multi-Sensor Balanced Fill-Flash together with Multi-Sensor Balanced Fill-Flash is called Automatic Balanced Fill-Flash with TTL Multi Sensor

### Standard TTL Flash

Standard TTL Flash can be performed with non-CPU Nikkor lens. (Can only be used with exposure mode set to “M” ➡P.50) With CPU Nikkor lens, Standard TTL Flash is automatically set when the camera is set to “M” exposure mode or Spot metering when using built-in flash. In Standard TTL Flash, automatic flash output level compensation is not available. This means that, even though the main subject is correctly exposed, the background may not be. Standard TTL Flash is useful when you want to highlight the main subject or perform flash exposure compensation. Monitor Pre-Flash is cancelled in Standard TTL Flash.



# SYNCHRO MODES AND THEIR FEATURES

You can select any of 5 modes to suit the type of shot and the desired effect.

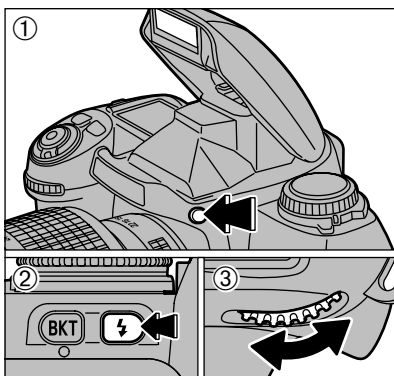

- ① Press the flash pop-up button to pop up the flash.
- ② Hold down the “Fn” button and,
- ③ Turn the main command dial to select the synchro mode. The icon shown on the top display panel changes as shown below.

⚠ When you are not using the flash, always keep it stowed away to prevent battery depletion.

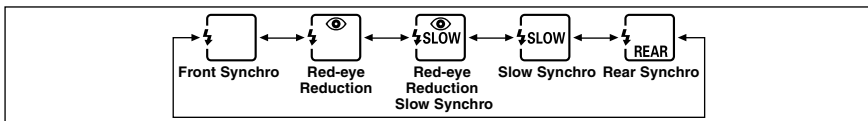

⚠ When some exposure mode and synchro mode combinations are selected, the synchro mode may be automatically changed subsequently.

Exposure mode	Synchro mode	Display during selection	Display after selection	Operation
P or A	Rear Synchro			Automatically set to Slow Synchro.
S or M	Red-eye Reduction Slow Synchro			Slow Synchro is cancelled (shutter speed not changed.)
	Slow Synchro			



## ⚡ FRONT SYNCHRO MODE

Can be used in all exposure modes. Select this mode for normal flash photography.



## ⚡ SLOW SLOW SYNCHRO MODE

Can be used in the “P” and “A” exposure modes. Because this mode uses a slow shutter speed, it captures the background while at the same time firing the flash to produce a shot that captures the atmosphere of a twilight or nighttime scene.



## ⚡ REAR REAR SYNCHRO MODE

Can be used in all exposure modes. In the “P” and “A” exposure modes, a slow shutter speed is used. The flash fires just before the shutter closes. This mode is effective in capturing the subject’s movement as a flow of light in a way that looks natural.

⚠ Rear-Synchro cannot be used with a studio flash system since the correct synchronisation cannot be obtained.



## ⚡ RED-EYE REDUCTION MODE

Can be used in all exposure modes. The Red-Eye Reduction lamp lights for approx. 1 sec. before the flash fires in order to reduce the red-eye effect in photos of people or animals.

## ⚡ SLOW RED-EYE REDUCTION SLOW SYNCHRO MODE

Can be used in the “P” and “A” exposure modes. This mode combines red-eye reduction with a slow shutter speed.

⚠ When a Nikon SB-28/28DX, SB-27 or SB-26 flash unit is used, the red-eye reduction lamp on the external flash fires.

⚠ Take care to ensure that the camera and the subjects (people) in the shot do not move until the shutter is released.

⚠ Depending on the type of lens mounted, the light from the red-eye reduction lamp may not reach the person, in which case the effect of the red-eye reduction lamp is lost.

## ■ Shutter Speeds

The synchronized shutter speed is 1/125 sec.

The shutter speeds that can be set vary depending on the combination of synchro mode and exposure mode, as shown below.

Synchro mode	Exposure mode		
	P or A	S	M
Front Synchro	1/125 to 1/60 sec. (automatically set by the camera*1)	1/125 to 30 sec.	1/125 to 30 sec. and <b>b u l b</b>
Slow Synchro	1/125 to 30 sec. (automatically set by the camera*2)	—	—
Rear Synchro	Automatically set to Slow Synchro. 1/125 to 30 sec. (automatically set by the camera*1, *2)	1/125 to 30 sec.	1/125 to 30 sec. and <b>b u l b</b>
Red-eye Reduction	1/125 to 1/60 sec. (automatically set by the camera)	1/125 to 30 sec.	1/125 to 30 sec. and <b>b u l b</b>
Red-eye Reduction Slow Synchro	1/125 to 30 sec. (automatically set by the camera*2)	—	—

\*1 When a Nikon SB-26, SB-25 or SB-24 flash unit is used, the synchro selector on the external flash unit sets the shutter speed.

\*2 Because a slow shutter speed is used, a tripod should be used to prevent camera shake.



# TAKING PICTURES USING THE BUILT-IN FLASH

Operation described in this section applies when the built-in flash and D- or G-type AF Nikkor are attached.

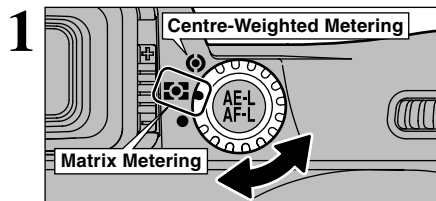

Set the metering system selector dial to “Matrix Metering” or “Center-weighted Metering”.

⚠ If you select “□” (Spot Metering), the flash control mode is switched to “TTL”.

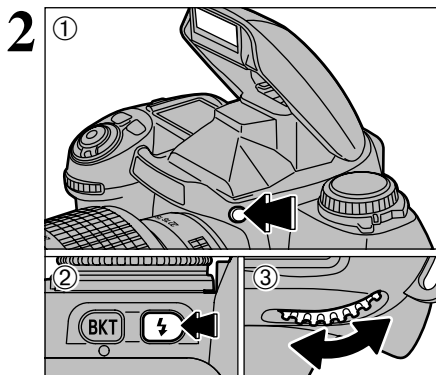

① Press the flash pop-up button to pop up the flash.  
 ② Hold down the “BKT” button and,  
 ③ Turn the main command dial to select the synchro mode.

⚠ When you are not using the flash, always keep it stowed away to prevent battery depletion.

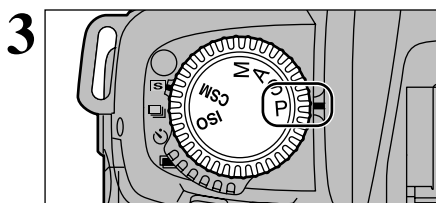

Set exposure mode and confirm shutter speed and aperture.



Check that the “⚡” (ready light) is displayed in the viewfinder.

⚠ If you take a number of continuous shots with the built-in flash, the “⚡” (ready light) may take a few moments to light.

⚠ The shutter cannot be released unless “⚡” appears without blinking in the viewfinder.

5 Bear in mind the composition, focus and effective flash range when taking pictures.

⚠ If the “⚡” (ready light) flashes for about 3 seconds after the shutter is released, this is a warning that the flash fired at full power and the shot may be underexposed. Play the image back to check it. If you decide to retake the shot, check the shooting distance, aperture, flash control range, etc. again before shooting.

⚠ If the subject is dark, the auxiliary AF-Assist illuminator fires to set the focus. See P.41 for details.

⚠ When you use the flash, shots are not taken continuously when the release mode is set to Continuous Shooting.

⚠ If the built-in flash is charging, camera-shake correction is not performed on a VR lens while the shutter button is pressed down halfway.

Exposure mode	Shutter speed	Aperture	Flash control mode
P	Synchronized shutter speed: 1/125 sec. See P.63 for details.	Automatically set by the camera	3D Multi BL
S		Any aperture	
A			TTL
M			

\* Shutter speeds faster than the synchronized speed (1/125 sec.) cannot be set. When “125” appears in the viewfinder display and the specified shutter speed flashes on the display panel, the actual shutter speed is 1/125 sec.

\* The shooting distance is determined by the ISO setting and the aperture. For the “A” and “M” exposure modes, see the table below.

\* For the “P” exposure mode, the widest aperture that can be set by the camera varies depending on the ISO setting. See P.69.

ISO setting	100	160	200	400
Widest aperture (built-in flash)	2.8	3.3	3.3	4

## Effective Range of the Built-in Flash

The effective range of the built-in flash varies depending on the ISO sensitivity and aperture settings used. Refer to the table below.

Flash control range (m)

Aperture	ISO setting Guide Nos shown in <>	100 <12>	160 <15>	200 <17>	400 <24>
	1.4	2.5-5.0	—	—	—
2	1.5-4.5	2.5-5.0	2.5-5.3	—	
2.8	1.0-3.3	1.5-4.7	2.2-5.0	3.0-6.0	
4	0.7-2.5	1.0-3.3	1.0-3.5	2.3-5.0	
5.6	0.6-1.7	0.8-2.2	0.8-2.5	2.0-3.5	
8	0.6-1.0	0.6-1.5	0.6-1.6	0.8-2.3	
11	—	—	0.6-1.0	0.6-1.6	
16	—	—	—	0.6-1.0	

\* The effective flash range can be calculated by dividing the guide number (12 for the built-in flash in this camera) by the specified aperture.

⚠ When the sensitivity is set to ISO 800 or 1600, the built-in flash will fire but the correct exposure may not be obtained. Use one of the following methods to check the results:

- Select “PREVIEW” as the photographed image display option in the SET-UP screen.
- Press the “” button to play back the image.

## LENSES THAT CAN BE USED WITH THE BUILT-IN FLASH

### Usable lenses with built-in flash

- 28 mm to 300 mm CPU lenses can be used with the built-in flash.
- Make sure to remove the lens hood.
- The built-in flash cannot be used at shooting distance less than 0.6 m.
- Vignetting occurs at the edges of the frame resulting in underexposure with the following zoom lenses, which have limitations in usable focal length or shooting distance:

Lens	Limitations
AF-S 17-35 mm f/2.8 ED	35 mm focal length at 1.5 m or longer shooting distance
AF 18-35 mm f/3.5-4.5 IF-ED	28 mm or longer focal length; and at 28 mm, at 1 m or longer shooting distance
AF 20-35 mm f/2.8	28 mm focal length at 2 m or longer shooting distance or 35 mm focal length at 0.7 m or longer shooting distance
AF 24-85 mm f/2.8-4	28 mm or longer focal length; and at 28 mm, at 1 m or longer shooting distance
AF 24-120 mm f/3.5-5.6	28 mm or longer focal length; and at 28 mm, at 0.8 m or longer shooting distance
AF-S 28-70 mm f/2.8 ED	50 mm or longer focal length; and at 50 mm, at 0.8 m or longer shooting distance
AF 28-85 mm f/3.5-4.5	28 mm or longer focal length; and at 28 mm, at 2 m or longer shooting distance
AF 35-70 mm f/2.8	35 mm or longer focal length; and at 35 mm, at 0.8 m or longer shooting distance
AF Micro 70-180 mm f/4.5-5.6 ED	70 mm or longer focal length; and at 70 mm, at 0.7 m or longer shooting distance

\* 28 mm to 200 mm non-CPU Nikkor lenses (AI-S, AI, AI-modified Nikkor) and Series-E lenses except 200 mm f/2 lens can be used with the built-in Flash. However following lenses have limitations in usable focal length or shooting distance:

- AI-S/AI 25-50 mm f/4 (40 mm or longer focal length; and at 40 mm, at 0.8 m or longer shooting distance)
- AI-S 28-85 mm f/3.5-4.5 (35 mm or longer focal length)
- AI 35-70 mm f/3.5 (35 mm or longer focal length; and at 35 mm, at 1 m or longer shooting distance)
- AI 28-45 mm f/4.5 (28 mm or longer focal length; and at 28 mm, at 1 m or longer shooting distance)
- AI-modified 50-300 mm f/4.5 (200 mm or longer focal length)
- AI-S/AI 50-300 mm f/4.5 (135 mm or longer focal length)
- AI-S 80-200 mm f/2.8 (105 mm or longer focal length)
- AI-modified 80-250 mm f/4 (135 mm or longer focal length)

## FLASH EXPOSURE COMPENSATION

Flash exposure compensation lets you intentionally change the correct exposure computed by the flash and the camera. For example, you can highlight the main subject by increasing the flash output or prevent the main subject from becoming too bright by decreasing the flash output.

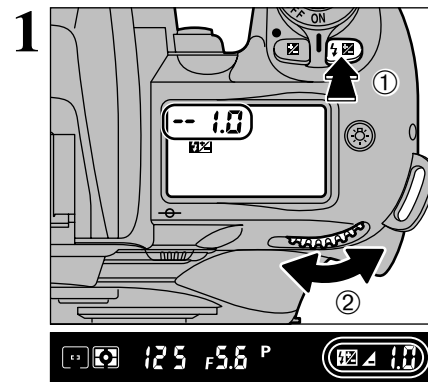

- ① Hold down the “” button (Flash Exposure Compensation) button and,
- ② Turn the main-command dial to set the amount of compensation.

The “” icon appears on the top display panel and on the viewfinder.

Compensation range: -3 EV to 1 EV in 1/2 EV increments

Compensation guide: Select + settings when the background is brighter than the subject and - settings when background is darker.

- 2 The remainder of the procedure is the same as for normal flash photography (→P.64).

### To check the amount of compensation

Press the “” (Flash Exposure Compensation) button.

### Sample Flash Exposure Compensation displays

Compensation amount	Top display panel	Viewfinder display
“0.0”		
“+0.5”		
“-0.5”		

### To cancel exposure compensation

- Set the compensation amount back to “0.0”.
- ⚡ Switching the camera off does not cancel Flash Exposure Compensation.

# NIKON FLASH UNITS THAT CAN BE USED

The Nikon flash models listed in the table below can be used with this camera. In the table, ① indicates D- or G-type Nikkor lenses (except IX-Nikkor), ② indicates CPU Nikkor lens other than D- or G-type (except AF Nikkor for F3AF) and ③ indicates non-CPU Nikkor lenses.

Flash	Flash mode Lens	TTL			A	M	REAR	REAR	Red-Eye Reduction	Monitor Pre-Flash*3
		3D Multi-Sensor Balanced Fill-Flash*1	Multi-Sensor Balanced Fill-Flash	Standard TTL flash*2	Non-TTL Auto	Manual	Repeating Flash	Rear-Curtain Sync		
SB-28, SB-28DX (Cordless)	①	○		○	○	○	○	○	○	○
	②		○*1	○	○	○	○	○	○	○
	③			○	○	○	○	○	○	○
SB-27 (Cordless)	①	○		○	○	○	○	○	○	○
	②		○*1	○	○	○	○	○	○	○
	③			○	○	○	○	○	○	○
SB-26*4 (Cordless)	①	○		○	○	○	○	○	○	○
	②		○*1	○	○	○	○	○	○	○
	③			○	○	○	○	○	○	○
SB-25 (Cordless)	①	○		○	○	○	○	○	○	○
	②		○*1	○	○	○	○	○	○	○
	③			○	○	○	○	○	○	○
SB-24 (Cordless)	① ②		○*1	○	○	○	○	○	○	○
	③			○	○	○	○	○	○	○
	① ②		○*6	○	○	○	○	○	○	○
SB-23, SB-29*5 SB-21B*5 (Cordless)	③			○	○	○	○	○	○	○
	① ②		○*6	○	○	○	○	○	○	○
	③			○	○	○	○	○	○	○
SB-22s, SB-22, SB-20, SB-16B, SB-15 (Cordless)	① ②		○*6	○	○	○	○	○	○	○
	③			○	○	○	○	○	○	○
	① ②		○*6	○	○	○	○	○	○	○
SB-11*7, SB-14	③			○	○	○	○	○	○	○

\*1 metering system other than Spot.

\*2 Standard TTL is performed with Spot Metering. Also, selecting Manual exposure mode automatically changes the TTL Auto Flash mode to Standard TTL with flash other than SB-28/28DX, 27, 26, 25 and 24 that are equipped with TTL Auto Flash.

\*3 When Spot metering is selected, Monitor Pre-Flash will not be fired.

\*4 Wireless Slave Flash can be performed with the SB-26. Shutter speed is automatically controlled to slower than 1/90 sec. when the Wireless Slave Flash selector is set to D.

\*5 With the SB-29 and SB-21B, autofocus can only be used when an AF Micro-Nikkor (60 mm, 105 mm, 200 mm and 70-180 mm) is attached.

\*6 Select exposure mode other than Manual or metering system other than Spot.

\*7 If TTL mode is used with the SB-11 or SB-14, the SC-23 TTL flash control cord is required for the connection, To use "A" or "M" mode, connect the SB-11 or SB-14 with the SC-13 and SU-2. The SC-11 or SC-15 can also be used to connect the SB-11 or SB-14, but in that case the Ready light in the camera's viewfinder display cannot be used and the shutter speed is not selected automatically.

## Notes on using Nikon flash units

- Refer to the instructions supplied with the flash unit for details. If your flash unit supports TTL mode and comes with instructions that include a table of camera types, refer to the section for group I cameras.
- The synchronized shutter speed when a flash is used is a slow speed of 1/125 sec. or slower.
- In TTL mode, the ISO sensitivity linked settings are ISO 100-400.
- With the SB-26, 25 or 24, flash sync mode set on the Speedlight overrides the setting on the camera body.
- If you set the camera's synchro mode to "Red-eye Reduction" or "Red-eye Reduction Slow Synchro" and then use a Nikon external flash unit that has its own red-eye reduction function, the red-eye reduction lamp on the external flash unit fires.

- Even when the optional flash with the AF-Assist Illuminator is attached, AF-Assist Illuminator does not emit light unless the conditions for AF-Assist Illumination are met.
- With SK-6 and SB-24 are attached, AF-Assist Illuminators of the camera body and the flash do not emit light.
- When the exposure mode is "P" Multi-Programmed Auto, the widest aperture that can be automatically set by the camera is governed by the ISO setting used, as shown in the table below.

ISO setting	100	160	200	400
Widest aperture (built-in flash)	2.8	3.3	3.3	4
Widest aperture (optional flash)	4	4.8	4.8	5.6

\* If an aperture that is wider than the controlled aperture is still too dark, the aperture is determined by widest aperture on the mounted lens.

- When flash exposure compensation is set, "F2" appears in the viewfinder without the compensation value.
- "FE E" in the top display panel and "P" in the viewfinder blink and the shutter cannot be released when the exposure mode is set to "P" and attached flash is not set to TTL Auto Flash. Set the flash mode to TTL, or set the camera's exposure mode to "S", "A" or "M".
- To cancel Monitor Pre-Flash when using the SB-28/28DX, 27, 26 or 25, select Spot metering.

## Flash attachments made by manufacturers other than Nikon

Use only Nikon flash models. Other units may damage the camera's electrical circuit due to incompatible voltage requirements (not compatible with 250V or higher), electric contact alignment or switch phase.

## Accessory shoe (with cover)

An optional flash, i.e. SB-28/28DX, SB-27, SB-26, SB-25, SB-24, SB-23 or SB-22s can be attached directly to the accessory shoe of the FinePix S2 Pro without a cord. This accessory shoe is equipped with a safetylock which prevents accidental drop when a flash with a safety-lock pin (i.e. SB-28/ 28DX, SB-27, SB-26, SB-25 or SB-22s) is attached.

Always install the accessory shoe cover when you are not using an external flash unit.

## Synchronizing terminal (with cap)

To use an external flash unit that requires a synchro cord, connect the synchro cord to the synchro cord terminal (with JIS-B locking screw). However, if you mount a Nikon SB-28/28DX, SB-50DX, SB-28, SB-27, SB-26, SB-25, SB-24, SB-23, SB-22s or SB-29 on the accessory shoe and then select Rear Synchro mode, do not connect other external flash units to the synchronizing terminal to provide additional flash for the shot.

## USING THE FUNCTION MENU WHEN TAKING PICTURES

You can use the Function menu to change the quality settings (White Balance, Quality, Resolution, Color, Tone, Sharpness) of saved images and the AF area settings.

1 Switch the camera on and set the camera to Photography mode. If the Auto Power Off function has switched the camera off, press the shutter button down halfway to switch it back on.

2 The functions change each time the “FUNC” button is pressed.

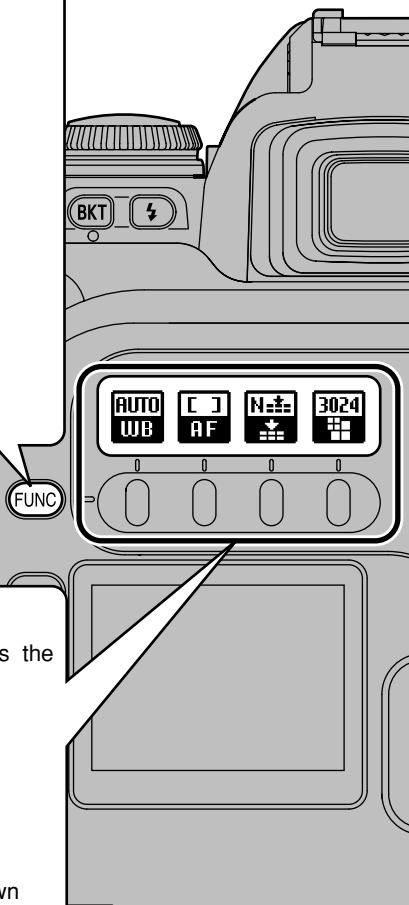
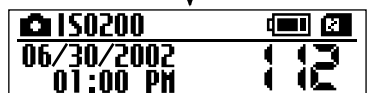

3 Method 1  
The setting changes each time you press the button.

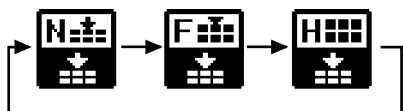

Method 2

The settings can be changed by holding down the button and pressing “▲” or “▼”.

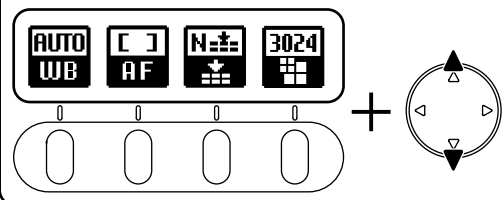

## FUNC WHITE BALANCE

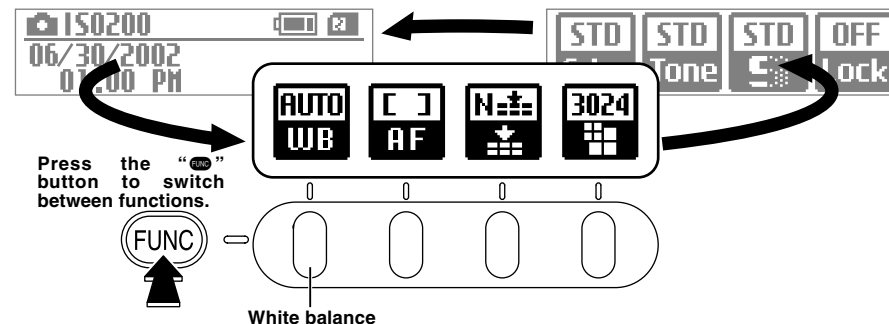

Change the settings when you want to set the white balance to suit the natural or artificial lighting conditions when you shoot.

When AUTO is selected, the correct white balance sometimes cannot be obtained under special light sources or for subjects where people's faces are highlighted, etc. In such cases, select the correct white balance setting for the light source.

• Factory default setting: AUTO

Display	Name	Description
	AUTO	The camera automatically determines the amount of light and the color information for the shot and takes the picture with a natural white balance.
	Custom 1	This setting uses the white balance setting specified by the photographer in the “SET-UP” menu (→P.91).
	Custom 2	
	Sunny	Select this setting for outdoor shots in fine weather when the light source for the shot is the sun.
	Shade	Select this setting for shots taken in shade or on cloudy days.
	Fluorescent 1	Select this setting for shots taken under “Daylight” fluorescent lamps.
	Fluorescent 2	Select this setting for shots taken under “Warm White” fluorescent lamps.
	Fluorescent 3	Select this setting for shots taken under “Cool White” fluorescent lamps.
	Incandescent	Select this setting for shots when the light source is incandescent bulbs or lights.

• When the flash fires, white balance settings other than AUTO and CUSTOM are ignored. To achieve a particular effect, take the shot without using the flash.

## FUNC AF AREA/QUALITY/RECORDED PIXELS

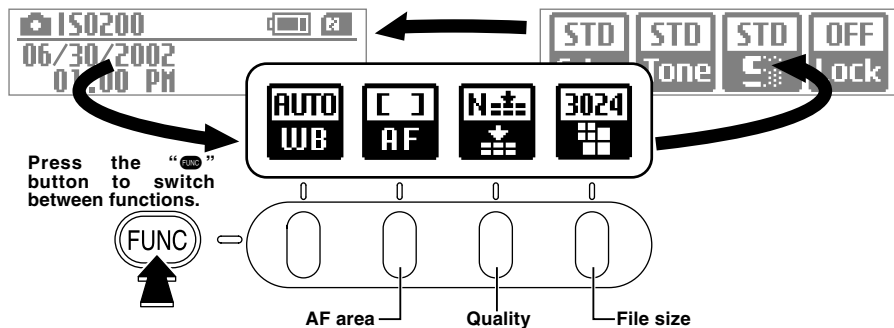

### AF AREA

Auto Focus provides two AF modes. In Single-area AF mode, the shot is focused using the selected focus area, while in Dynamic AF mode, multiple focus areas are used to set the focus. See P.39 for more detailed information on the AF area modes.

- Factory default setting: Single-area

Display	Mode	Focus area	Viewfinder, Top panel display	Description
	Single-area AF			Useful for situations where you want to focus accurately on a more or less stationary subject.
	Dynamic AF	or 	or 	Useful for shots where it is difficult to accurately keep the subject in a given focus area, such as when you are tracking a moving subject.

### QUALITY

Sets the quality of the photographed image. Select settings suited to the purposes for which the photograph will be used.

Select "Fine" for better quality and "High" to record an uncompressed image with the highest available image quality.

The "Normal" setting provides ample image quality for most purposes.

- Factory default setting: Normal

Display	Name	Description
	Normal	Allows you to record the largest number of images.
	Fine	Records images in high quality bettered only by the "High" setting. This mode allows you to record more images than the "High" setting.
	High	TIFF-RGB: Select this setting to record uncompressed images with the highest available image quality. CCD-RAW (⇨P.122): No image processing is performed on the camera. Select this setting when you want to process the image on a PC.

### RECORDED PIXELS

Sets the size of the photographed image.

- Factory default setting: 3024 × 2016

Display	Name	Description
	1440	Sets the image size to 1440 × 960 pixels (approx. 1.38 megapixels). You can record the largest number of images in this mode.
	2304	Sets the image size to 2304 × 1536 pixels (approx. 3.53 megapixels).
	3024	Sets the image size to 3024 × 2016 pixels (approx. 6.12 megapixels).
	4256	Sets the image size to 4256 × 2848 pixels (approx. 12.12 megapixels). You can record the fewest images in this mode.

#### ◆ Shooting CCD-RAW images ◆

CCD-RAW images, because they are not processed on the camera, can only be recorded at the "4256 × 2848" image size. These images must always be processed using software on a computer.

- To shoot CCD-RAW images, set up the camera as follows:
  1. Select the "CCD-RAW" setting as the "HIGH mode" option in SET-UP (⇨P.89).
  2. Set the Quality to "High".

⚠ When you display a CCD-RAW image, the frame number is highlighted.

⚠ "4256" is displayed as the resolution.

## FUNC COLOR/TONE/SHARPNESS/FUNCTION LOCK

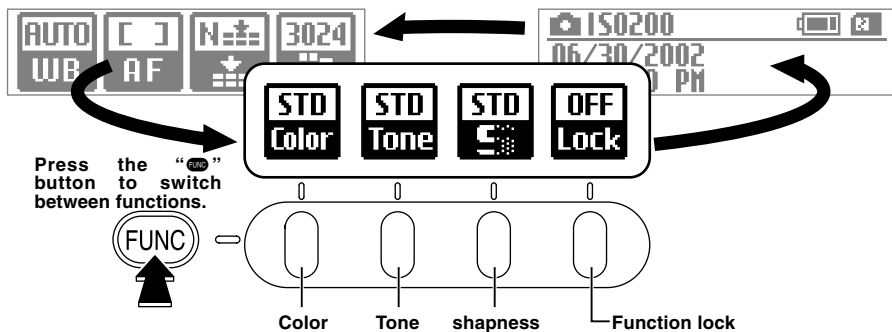

### COLOR

Use the procedure below to set the density of the color used when images are shot.

- Factory default setting: STANDARD

Display	Name	Description
	STD	This setting sets the standard color density.
	HIGH	This setting provides a higher color density than the "STD" setting.
	ORG	This setting specifies a lower color density than the "STD" setting. Use this setting for images that will undergo image processing for use in commercial printing.
	B/W	This setting converts the colors in the photographed image to black and white.

- If you want to view or print the image data directly, do not select "ORG".

### TONE

Use the procedure below to set the contrast when images are shot.

- Factory default setting: STANDARD

Display	Name	Description
	STD	This setting sets the contrast for photographed images to the standard level.
	HARD	Use this setting for images that will undergo image processing for use in commercial printing. This setting provides a higher level of contrast than the "STD" setting.
	ORG	This setting specifies a lower contrast than the "STD" setting. Use this setting for images that will undergo image processing for use in commercial printing.

- If you want to view or print the image data directly, do not select "ORG".

### SHARPNESS

Use this setting to soften or sharpen the outlines in an image and to adjust the quality of the photographed image.

- Factory default setting: STANDARD

Display	Name	Description
	STD	This setting applies the optimum level of sharpness for normal shots.
	HARD	This setting sharpens the outlines in an image and is best for images of subjects such as buildings or text where clarity is important.
	OFF	Sharpness processing is not applied in this setting. Use this setting for images that will undergo image processing for use in commercial printing.

- If you want to view or print the image data directly, do not select "OFF".

### FUNCTION LOCK

This feature allows you to lock the function menu settings so that they cannot be changed (to prevent accidental misuse).

- Factory default setting: OFF

Display	Name	Description
	OFF	Releases the function lock.
	ON	Sets the function lock. The settings cannot be changed once the function lock is applied. To change the settings, first press the "F4" button to cancel function lock.

You can use this menu to work with a displayed image (histogram display, erase, protect) and switch between multi-frame and single-frame playback.

1 Switch the camera on and press the "PLAY" button to select Playback mode. If the Auto Power Off function has switched the camera off, press the shutter button down halfway to switch it back on.

2 The functions change each time the "FUNC" button is pressed.

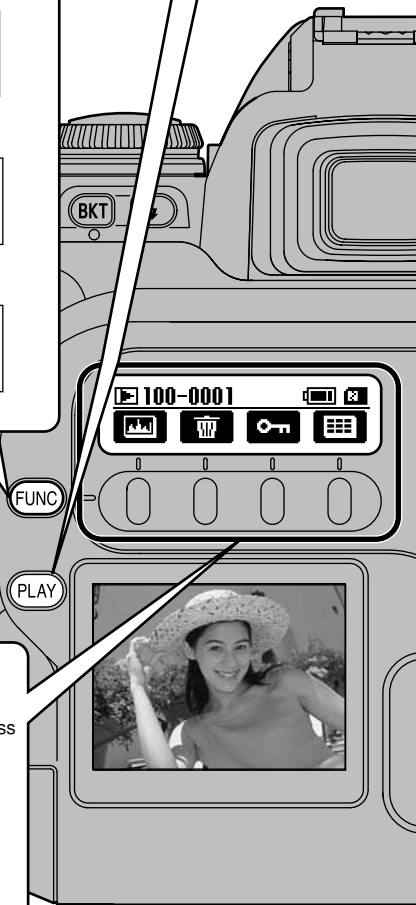
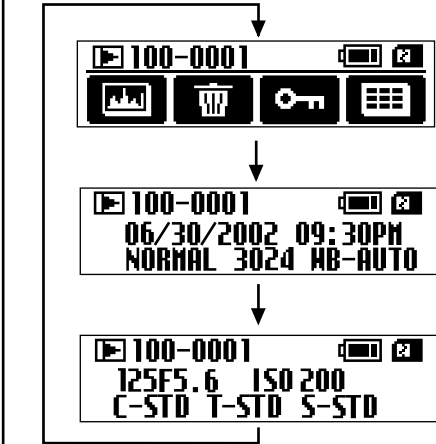

3



Histogram

The histogram display changes each time you press the button.



Single-frame erase

Erases an image.



Protect frame

Protects or unprotects an image.



Multi-frame playback

The mode switches between single-frame and multi-frame playback each time you press the button.

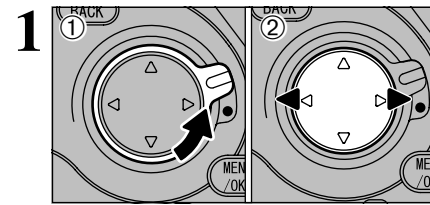

Unlock the 4-direction button ① and press "◀" or "▶" ② to select the frame for which the histogram is to be displayed.

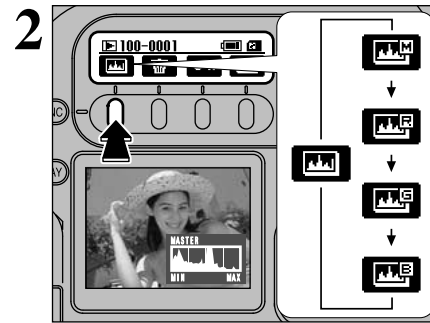

The histogram display changes each time you press the "F1" button. Histograms can be displayed for both playback images and preview images.

- : Image histogram for brightness shown.
- : Image histogram for red shown.
- : Image histogram for green shown.
- : Image histogram for blue shown.

- ⚙ If "MASTER" does not appear on the rear display panel, press the "MENU" button to change the screen.
- ⚙ A histogram is a graph that shows the distribution of brightness in an image.

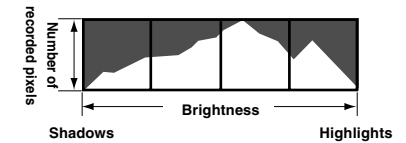

3 When you have finished the procedure, lock the 4-direction button to prevent accidental improper use.

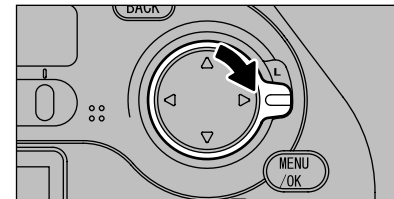

■ About the Histogram Display

		Even distribution	Sloping up to the right	Sloping up to the left
Icon	Mode			
	MASTER brightness	Correct exposure	Overexposed	Underexposed

## FUNC ERASING SINGLE-FRAME

Use this function to erase an image you have photographed.

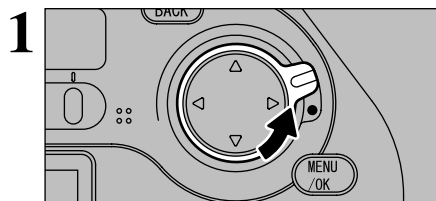

Unlock the 4-direction button.

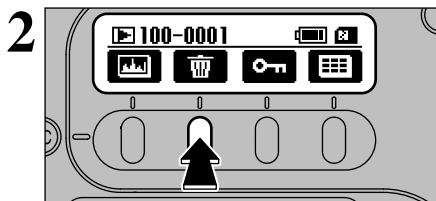

Press the "F2" button to display the erase confirmation screen.

⚠ If "☒" does not appear on the rear display panel, press the "☒" button to change the screen.

⚠ If the currently displayed frame is protected, "☒" appears instead of "☒" and the "☒" icon is displayed in the top-right corner of the LCD monitor.

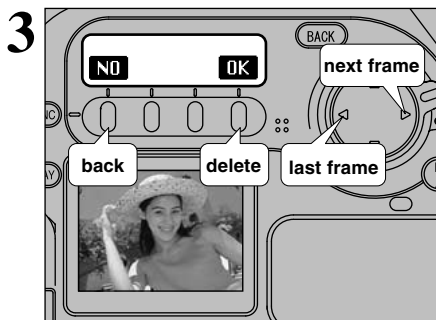

**The following operations can be used in the erase confirmation screen:**

To select the frame: "◀" or "▶"

To erase the displayed frame: "OK" ("F4" button)

To return to the previous frame:

"NO" ("F1" button) or "BACK" button

⚠ If "(! PROTECTED FRAME)" displayed for a frame indicates that the frame is protected. Unprotect the frame before erasing it.

If the "DPOF SPECIFIED. ERASE ALL OK?" message appears, press the "MENU/OK" button again to erase the files.

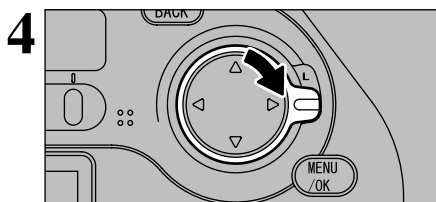

When you have finished the procedure, lock the 4-direction button to prevent accidental improper use.

## FUNC SINGLE-FRAME PROTECT

The "Protect" setting prevents an image from being accidentally erased.

Protected images cannot be erased by the "Erasing single-frame" or "Erase all" function. However, the "Format" function erases all files.

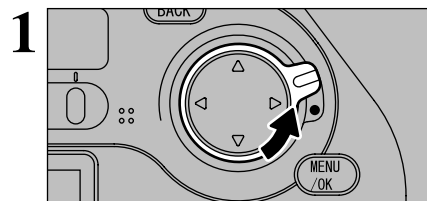

Unlock the 4-direction button.

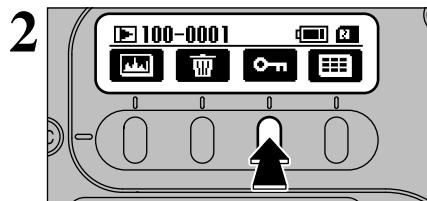

Press the "F3" button to display the protection screen.

⚠ If "☒" does not appear on the rear display panel, press the "☒" button to change the screen.

⚠ If the currently displayed frame is protected, "☒" is displayed instead of "☒".

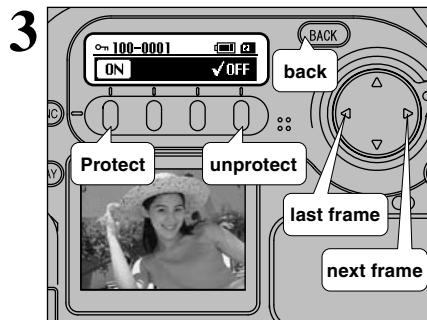

**The following operations can be used in the protection screen:**

To select the frame: "◀" or "▶"

To protect the frame: "ON" ("F1" button)

To unprotect the frame: "OFF" ("F4" button)

To return to the previous frame: "BACK" button

### ■ To check protected frames

	LCD monitor	Rear display panel (protection screen)	Rear display panel (during single-frame playback)
Protected			
Not protected	No icon		

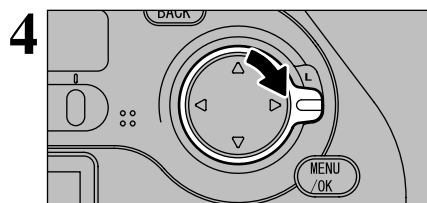

When you have finished the procedure, lock the 4-direction button to prevent accidental improper use.



## FUNC MULTI-FRAME PLAYBACK

Multi-frame playback displays 9 frames at a time and is useful for situations such as when you are searching for one image among many.

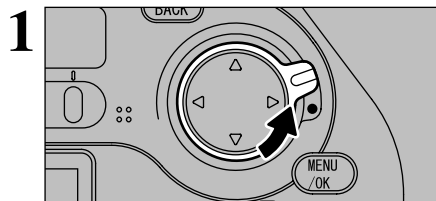

1 Unlock the 4-direction button.

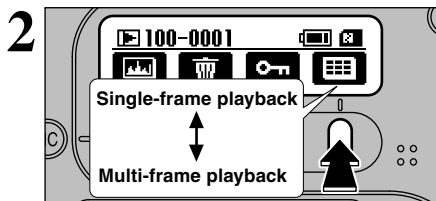

2 Press the "F4" button.

☛ If "F4" does not appear on the rear display panel, press the "MENU/OK" button to change the screen.



3 Press "◀", "▶", "▲" or "▼" to move the cursor (the orange frame) and select a frame. Press "▼" or "▲" several times to move to the next or previous page.

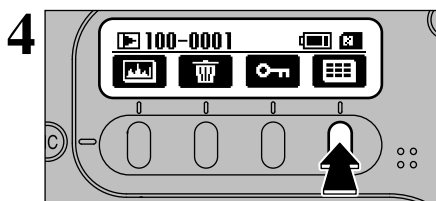

4 You can view the selected image enlarged by pressing the "F4" button again.

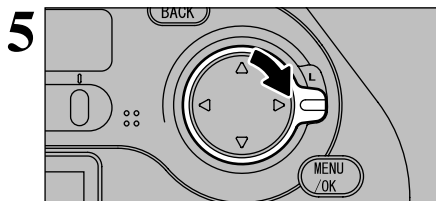

5 When you have finished the procedure, lock the 4-direction button to prevent accidental improper use.

## MENU/OK PLAYBACK MENU

### ERASE

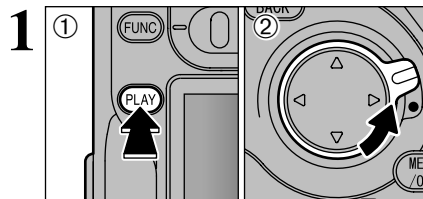

- 1 Press the "PLAY" button to select Playback mode.
- 2 Unlock the 4-direction button.

When you have finished using the menu, lock the 4-direction button to prevent accidental use.

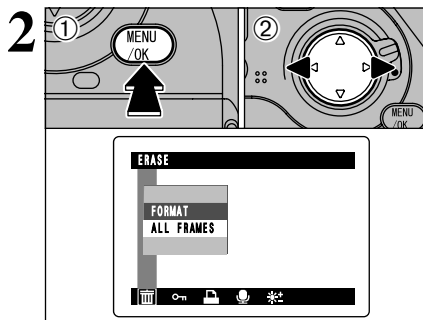

- 1 Press the "MENU/OK" button to display the menu screen.
- 2 Use "◀▶" to select "ERASE".

☛ Press the "BACK" button to exit the menu.

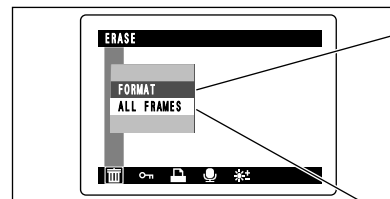

#### FORMAT

Formatting erases all the files. Initialize the media for use in the camera. Copy any files that you want to keep to your PC beforehand.

☛ Protected files are also erased.

#### ALL FRAMES

This function erases all the unprotected frames.

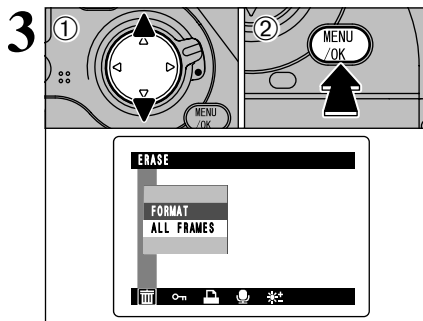

- 1 Press "▲" or "▼" to select "ALL FRAMES" or "FORMAT".
- 2 Press the "MENU/OK" button.

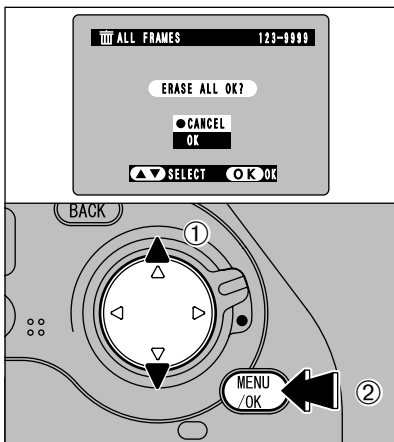

### Erase All

- ① Press "▲" or "▼" to select "OK".
- ② Press the "MENU/OK" button to erase all the unprotected files.

⚠ This may take some time if there is a large number of recorded frames. To interrupt the procedure, press "BACK" button.

If the "DPOF SPECIFIED. ERASE ALL OK ?" message appears, press "▲" or "▼" to select "OK" and then press the "MENU/OK" button to erase the files.

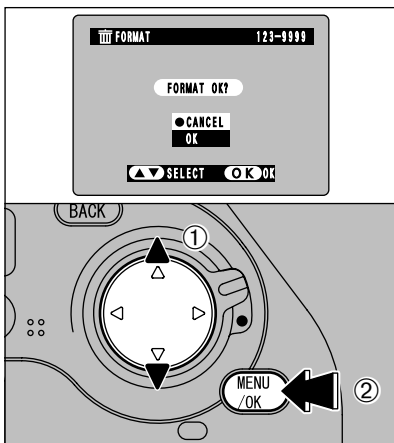

### FORMAT

- ① Press "▲" or "▼" to select "OK".
- ② Pressing the "MENU/OK" button erases all the files and initializes the media.

⚠ If the "CARD ERROR" "WRITE ERROR" "READ ERROR" or "CARD NOT INITIALIZED" message appears, refer to P.116 before formatting the media and take the appropriate measures.

"Format" erases all the files, including any protected files.

### SETTING AND REMOVING PROTECTION FOR ALL FRAMES

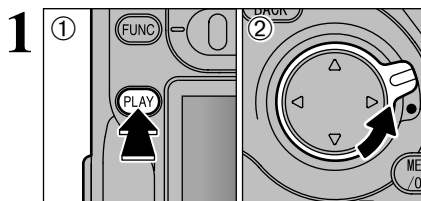

- ① Press the "PLAY" button to select Playback mode.
- ② Unlock the 4-direction button.

When you have finished using the menu, lock the 4-direction button to prevent accidental use.

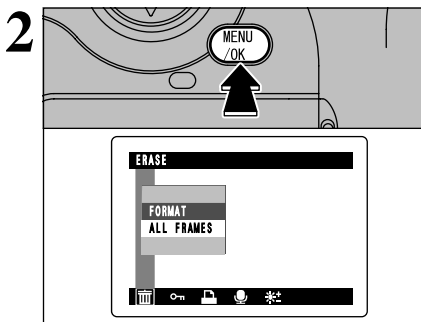

Press the "MENU/OK" button to display the menu on the monitor.

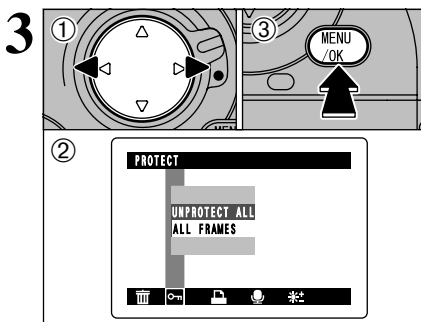

- ① Use "◀" or "▶" to select "🔑".
- ② Press "▲" or "▼" to select "ALL FRAMES" or "UNPROTECT ALL".
- ③ Press the "MENU/OK" button.

Formatting erases all images, including protected images (→P.82).

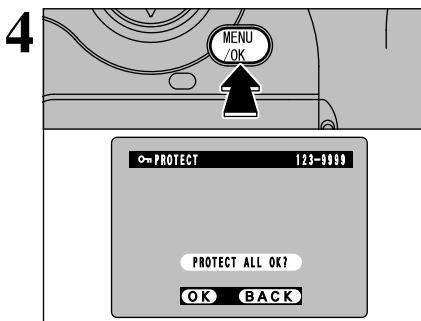

A confirmation message will appear to proceed, press the "MENU/OK" button.

- ⚠ This may take some time if there is a large number of frames. To interrupt the procedure, press "BACK" button.
- ⚠ To end frame protection, press the "BACK" button and return to the menu.

**HOW TO SPECIFY PRINT OPTIONS (DPOF)**



DPOF stands for Digital Print Order Format and refers to a format that is used for recording printing specifications for images shot using a digital camera on media such as SmartMedia. The recorded specifications include information on which frames are to be printed.

This section gives a detailed description of how to order your prints with the FinePix S2 Pro.

On the FinePix S2 Pro, you can specify only one print per image in the DPOF settings.

\* Note that some printers do not support date and time imprinting or specification of the number of prints.

\* Note that the warnings shown below may be displayed while you are specifying the prints.

**DPOF SPECIFIED. ERASE OK?**

**DPOF SPECIFIED. ERASE ALL OK?** (⇒P.116)

When you erase the image, the DPOF setting for that image is deleted at the same time.

**RESET DPOF OK?** (⇒P.117)

If you load a media that contains frames specified for printing on another camera, those print specifications are all reset and replaced by the new print specifications.

**! DPOF FILE ERROR** (⇒P.117)

Up to 999 frames can be specified on the same media.

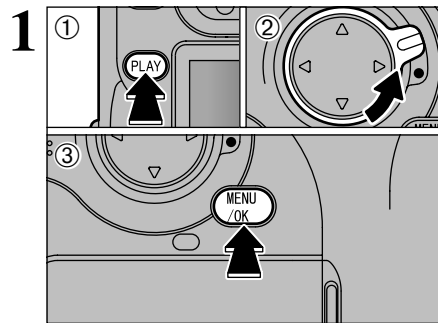

- ① Press the "PLAY" button to select Playback mode.
- ② Unlock the 4-direction button.
- ③ Press the "MENU/OK" button to display the menu screen.

When you have finished using the menu, lock the 4-direction button to prevent accidental use.

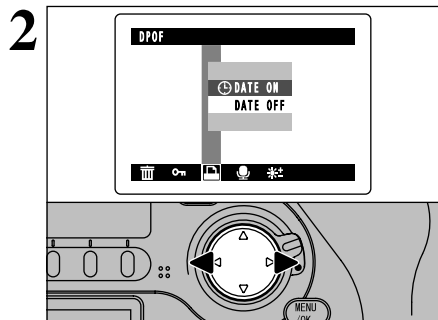

Use "◀" to select "DPOF".

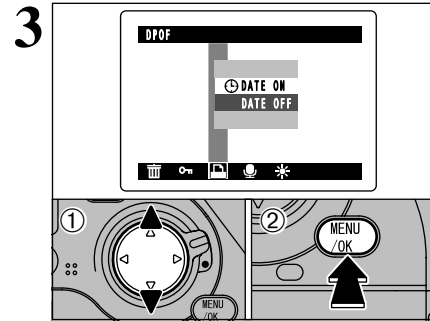

- ① Use "▲" and "▼" to select "DATE ON" or "DATE OFF".
  - ② Press the "MENU/OK" button.
- The selected setting is then valid for all frames with DPOF settings.

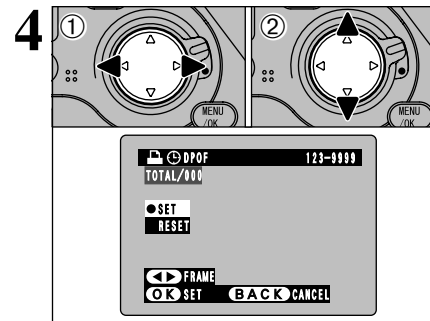

- ① Use "◀" or "▶" to display the frame for which you want to specify DPOF settings.
  - ② Use "▲" or "▼" to select the setting for the frame to be printed.
- To specify more DPOF settings, repeat steps ① and ②.
- Do not press the "MENU/OK" button until you have finished specifying all the DPOF settings for your images.

- ⚡ DPOF settings cannot be specified for CCD-RAW files because they cannot be printed without first being processed.
- ⚡ "TOTAL" shows the total number of frames for which prints have been ordered.

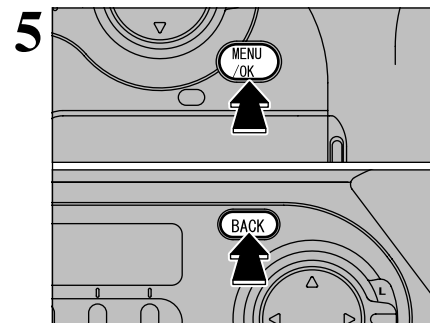

When you have finished specifying the DPOF settings, always press the "MENU/OK" button to confirm the settings. If you press the "BACK" button, no DPOF settings are specified.

- ⚡ You can only specify one print per frame in the DPOF settings. Note also that you can specify prints for up to 999 frames on the same SmartMedia.

Pressing the "MENU/OK" button confirms all the settings. Note that you cannot change the settings later.

**◆ Additional DPOF settings cannot be specified ◆**



If you select a frame for which DPOF settings have already been specified, the "RESET DPOF OK?" message appears. Pressing the "MENU/OK" button erases all the DPOF settings already specified. You must then specify the DPOF settings again.

- ⚡ Press the "BACK" button to leave the previous settings unchanged.
- ⚡ During playback, check that the "D" icon is displayed for the previous settings.

**VOICE MEMO (AUDIO RECORDING)**

This function allows you to add a voice memo (comment) up to 30 seconds long to an image.

- Recording time: Max. 30 sec.  
Audio format: WAVE (→P.122)  
PCM recording format  
Audio file size: Approx. 240 KB (for a 30 seconds recording)

You can also add a voice memo immediately after taking the shot. See P.93 for details.  
Recorded voice memos cannot be played back on the camera. To play back a voice memo, use a computer with the bundled FinePixViewer application installed.

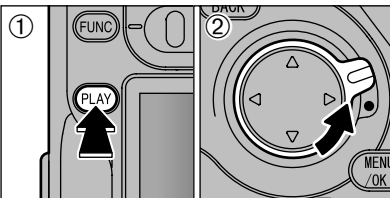
**1**  ① Press the “PLAY” button to select Playback mode.  
② Unlock the 4-direction button.

When you have finished using the menu, lock the 4-direction button to prevent accidental use.

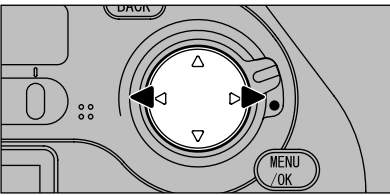
**2**  Use “◀” and “▶” to select the image to which you want to add a voice memo.

• Voice memos cannot be added to protected frames. Unprotect the frame before adding a voice memo.

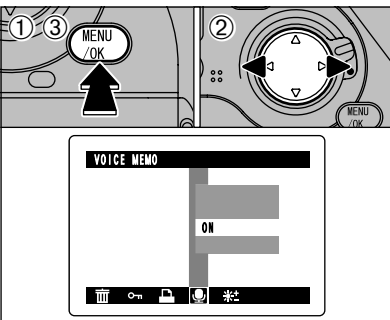
**3**  ① Press the “MENU/OK” button to display the menu screen.  
② Use “◀▶” to select “VOICE MEMO”.  
③ Press the “MENU/OK” button.

The LCD monitor displays the "VOICE MEMO" menu screen with a large "ON" indicator.

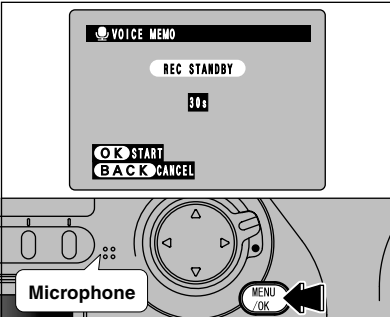
**4**  “REC STANDBY” appears on the LCD monitor. Press the “MENU/OK” button to begin recording.

• The recording time may be shorter, depending on the amount of space available on the media.

Face the microphone on the back of the camera as you record the voice memo. For best results, position the microphone about 20 cm away from your mouth during recording.

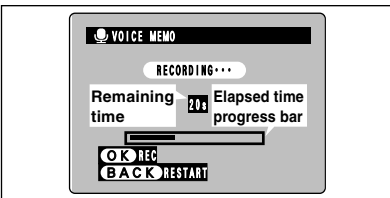
**5**  The remaining time and an elapsed time progress bar are shown on the LCD monitor during audio recording.

• To end recording mid-way, press the “MENU/OK” button.

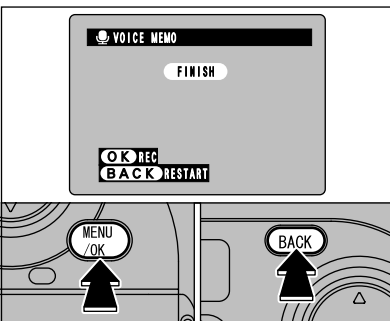
**6**  After 30 seconds of recording, “FINISH” appears on the LCD monitor.  
**To finish:** Press the “MENU/OK” button.  
**To re-record your comment:** Press the “BACK” button.

◆ **When the Image Already Has a Voice Memo** ◆

 If you select an image that already has a voice memo, a screen appears in which you can select whether or not to rerecord the memo. Press “▲” or “▼” to return to the previous screen or proceed with the recording and then press the “MENU/OK” button. To check a recorded voice memo, use the FinePixViewer application on a computer to play back the voice memo.

**LCD BRIGHTNESS**

**1**

① Press the "PLAY" button to select Playback mode.  
② Unlock the 4-direction button.

When you have finished using the menu, lock the 4-direction button to prevent accidental use.

**2**

① Press the "MENU/OK" button to display the menu screen.  
② Use "◀" to select "\*+".

**3**

① Pressing the "MENU/OK" button displays the monitor brightness setting screen.  
② Press "◀" or "▶" to adjust the monitor brightness.

◆ **Brightness adjustment checking bar** ◆

You can specify whether or not the brightness adjustment checking bar is displayed in the brightness setting screen.

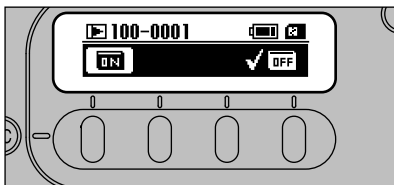

■ **SET-UP Menu Options**

Setting	Display	Default	Details
IMAGE DISPLAY	OFF/POSTVIEW/ PREVIEW  PREVIEW	OFF	Use this setting to specify whether previews of photographed images are displayed for checking. See P.90 for details.
CUSTOM WB	SET	—	Use this setting to specify an the correct white balance setting for a light source. See P.91 for details.
HIGH MODE	TIFF-RGB/ CCD-RAW	TIFF-RGB	When "HIGH" is specified as the Quality setting, use this setting to specify the file format used.
MEDIA	SMARTMEDIA/ CF Type II	SMART MEDIA	Use this setting to specify the media used when a SmartMedia and a Microdrive are loaded in the camera.
TEST-SHOOTING (NO CARD)	ON/OFF	ON	Set this option to ON to allow the shutter to be released when there is no media in the camera.
VOICE MEMO	OFF/ON	OFF	See P.93 for details.
FRAME No.	RENEW/CONT.	RENEW	See P.94 for details.
PC MODE	1394 DOWNLOADING/ USB DOWNLOADING/ 1394 SHOOTING	1394 DOWN LOADING	See P.100-103 for details.
BEEP	LOW/HIGH/OFF	LOW	Use this setting to set the volume of the beep emitted when the camera controls are used.
LANGUAGE	ENGLISH/ FRANCAIS/ DEUTSCH/ JAPANESE	ENGLISH	Use this setting to specify the language used for LCD monitor display.
DATE/TIME	SET	—	See P.24 for details.
RESET ALL	OK	—	Use this setting to reset all the settings in the SET-UP menu other than DATE/TIME and CUSTOM WB.

**Setup operations**

**1**

① Switch the camera on and select Photography mode.  
② Press the "MENU/OK" button to display the SET-UP screen.

Always switch the camera off when you replace the batteries. If you open the battery cover or disconnect the AC power adapter without switching the camera off, the camera settings may revert to the factory default settings set at shipment.

**2**

① Unlock the 4-direction button.  
② Press "▲" or "▼" to select an option and "◀" or "▶" to change the setting.  
③ When you have completed the settings, press the "MENU/OK" button.

Press "▶" for the "CUSTOM WB", "DATE/TIME" and "RESET ALL" settings.

When you have finished using the menu, lock the 4-direction button to prevent accidental use.

## SET-UP

### IMAGE DISPLAY

This setting allows you to specify whether the resulting image is displayed after you take a shot.

- OFF** : The photographed image is automatically recorded without being displayed.
- POSTVIEW** : The photographed image is displayed for about 2 seconds and is then automatically recorded.
- PREVIEW** : The photographed image is displayed so that you can check the image and choose whether to record it.
- PREVIEW** (with histogram icon): A preview that includes the histogram is shown.

Preview image display is cancelled when the Auto Power Off function operates (after 15 seconds under the default setting). Record preview images before the Auto Power Off function is triggered.

### Using the Preview Function

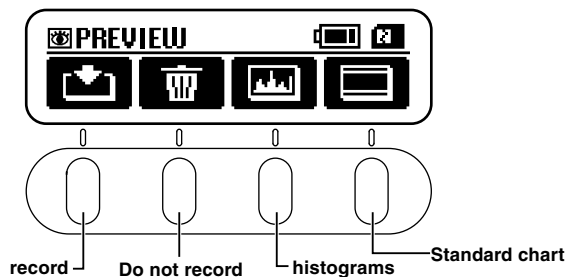

#### Preview zoom

Unlock the 4-direction button and press “▲” or “▼” to zoom in or out.

To view another part of the image, press the “PLAY” button and then use the “◀”, “▶”, “▲” and “▼” buttons to move around. To return to zoom mode, press the “PLAY” button again.



#### Histogram

Pressing this button displays the histogram. The display changes in a cycle from MASTER → R → G → B each time the button is pressed.

See P.77 for more information on histograms.

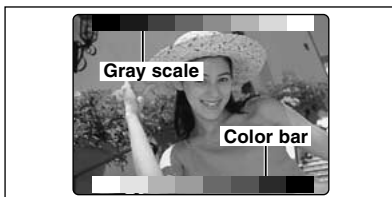

#### Standard chart

A “gray scale” is displayed in the upper part of the LCD monitor and a “color bar” is displayed in the lower part. You can check the brightness and color tones of the image by comparing the image with the colors in the bars.

### SETTING THE CUSTOM WB

- Use this function to set the correct white balance for a light source. You can also use this function to achieve a desired special effect. Press the “F1” (custom WB 1) button or the “F4” (custom WB 2) button to select the custom white balance you want to set.

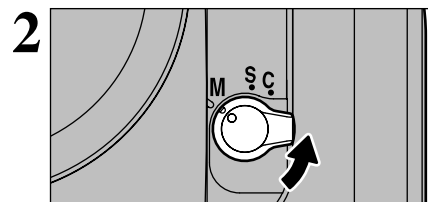
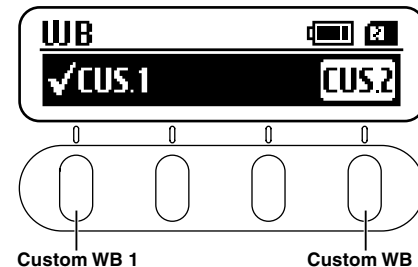

- Turn the focus mode selector switch to “M” (Manual focus) and set the focus manually.

The camera's auto focus function may be unable to focus on a subject such as a white sheet of paper, which will prevent the shutter from operating.

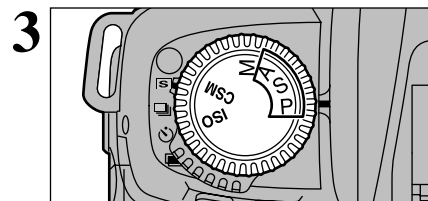

- Set the exposure mode to “P”, “S” or “A”.

While a custom white balance can also be measured in “M” mode, the image may be extremely overexposed or underexposed so that the optimum measurement is not taken.

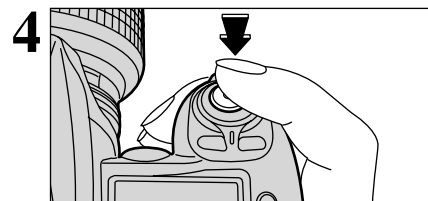

- Hold up a page of white paper or a similar object under the target light source so that the paper fills the viewfinder screen. Then press the shutter button to set the custom white balance.

Range of custom WB settings  
Color temperatures from approx. 2800 K to 9500 K

The white balance setting is not applied to the image on the screen.

#### Example

You can deliberately change the white balance in photographed images by using colored paper instead of white paper.

## SET-UP

5

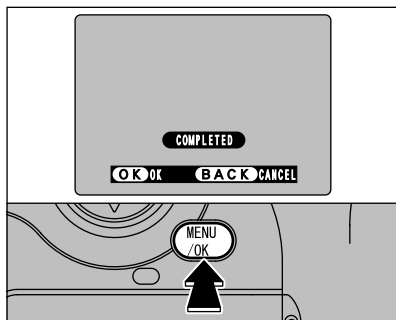

If the exposure is measured correctly, “COMPLETED” appears on the LCD monitor. Press the “MENU/OK” button to confirm the setting.

- After you take a photograph, you should check the color tones (white balance) in the image.
  - Select “PREVIEW” as the photographed image display option (⇒P.90) in the SET-UP screen.
  - Press the “” button (⇒P.34).
- When you have finished setting the white balance, select the focus mode you want to use.

### ■ When the exposure is not measured correctly

	Remedy
	The subject is too bright. Use a negative (-) exposure compensation value and set the white balance again.
	The subject is too dark. Use a positive (+) exposure compensation value and set the white balance again.
	Because the exposure is outside the range of valid custom white balance settings, the maximum (or minimum) value has been set. <ul style="list-style-type: none"> <li>Available custom WB settings: Color temperatures of approx. 2800 K to 9500 K</li> </ul>

## VOICE MEMO

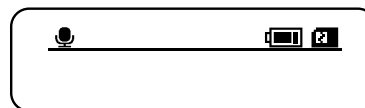

Recorded voice memos cannot be played back on the camera. To play back a voice memo, use a computer with the bundled FinePixViewer application installed.

If you set the Voice Memo option to “ON”, the “” icon appears on the rear display panel. Immediately after you take the shot, you can add a voice memo (comment) up to 30 seconds long to the image.

- Recording format: WAVE (⇒P.122) PCM recording format
- Audio file size: Approx. 240 KB (for a 30 seconds recording)

The recording time may be shorter, depending on the amount of space available on the media.

### Recording procedure

Set the release mode to “” (Single-frame) and take the picture. After you take the picture, “REC STANDBY” appears on the screen.

- Voice memos cannot be recorded in the “” (Continuous shooting) release mode.
- If you do not want to record a caption, press the “BACK” button. Note that the image is still recorded.
- The LCD monitor switches off again when recording ends.

When recording the voice memo, speak into the microphone (⇒P.10) on the left of the 4-direction button. For best results, position the microphone about 20 cm away from your mouth during recording.

1

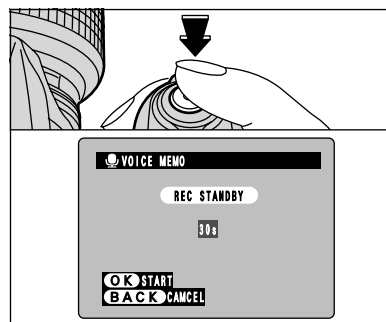

2

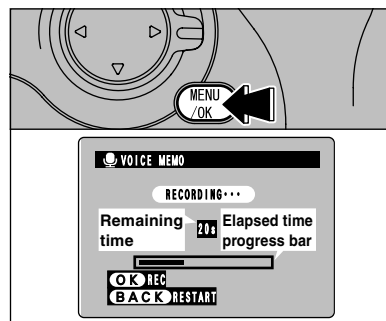

Press the “MENU/OK” button to begin recording. The remaining time and an elapsed time progress bar are shown on the LCD monitor during audio recording.

- The recording time may be shorter, depending on the amount of space available on the media.
- To end recording mid-way, press the “MENU/OK” button.

3

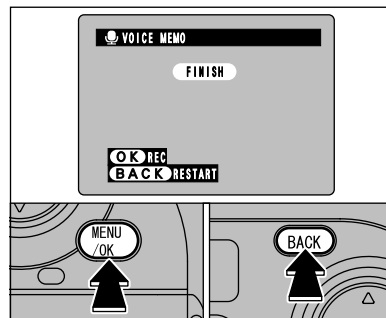

After 30 seconds of recording, “FINISH” appears on the screen.

To end recording: Press the “MENU/OK” button. To record the comment again: Press the “BACK” button.

**FRAME No. MEMORY**

Use this feature to manage the file numbers for frames you have shot. Setting this function to "CONT." is useful as a way of ensuring that the file names for images recorded on a computer are not duplicated.

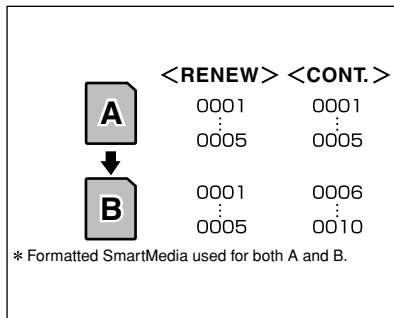

**RENEW:** Pictures are stored on each media beginning with a file number "0001".  
**CONT. :** Pictures are stored beginning from the highest file number stored on the last media used.

⚠ If the media already contains image files with file numbers higher than the highest file number on the last media, images are stored beginning from the highest file number on the current media.

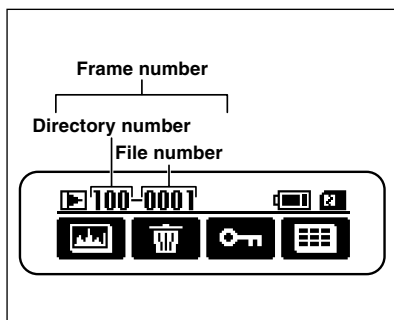

You can check the file number by viewing the image. The last 4 digits of the 7-digit number in the top right corner of the screen are the file numbers, while the first 3 digits show the directory number.

- ⚠ When you change the media, always switch the camera off before you open the media slot cover. If you open the slot cover without switching the camera off, the frame number memory will not function.
- ⚠ File numbers run from 0001 to 9999. Once 9999 is exceeded, the directory number changes from 100 to 101. The maximum number is 999-9999.
- ⚠ If you switch the Frame No. Memory function off, the highest file number stored by the function is reset.
- ⚠ The displayed frame number may differ for images photographed on other cameras.
- ⚠ The frame number is reset if the camera is left for a long period with the batteries removed (Settings are retained for roughly 6 months once the batteries have been loaded for 2 days or more).

**TWO-BUTTON RESET**

Two-Button Reset lets you instantly reset specified settings to their original initial settings.

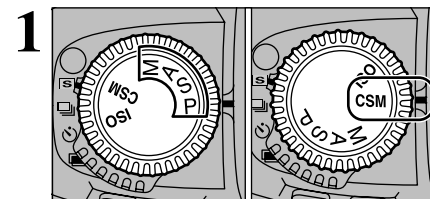

Set the exposure mode dial to "P", "S", "A", "M" or "CSM" and select the settings to be reset.

Exposure mode dial	Reset Settings																
"P", "S", "A", "M"	The photography functions are reset as shown below. <table border="1"> <thead> <tr> <th>Function</th> <th>Condition</th> </tr> </thead> <tbody> <tr> <td>Focus area</td> <td>Centre</td> </tr> <tr> <td>Flexible Program</td> <td>Cancelled</td> </tr> <tr> <td>Exposure compensation</td> <td>Cancelled</td> </tr> <tr> <td>Auto Exposure Lock</td> <td>Cancelled</td> </tr> <tr> <td>Auto Exposure Bracketing</td> <td>Cancelled</td> </tr> <tr> <td>Flash Sync mode</td> <td>Front-curtain sync</td> </tr> <tr> <td>Flash exposure compensation</td> <td>Cancelled</td> </tr> </tbody> </table>	Function	Condition	Focus area	Centre	Flexible Program	Cancelled	Exposure compensation	Cancelled	Auto Exposure Lock	Cancelled	Auto Exposure Bracketing	Cancelled	Flash Sync mode	Front-curtain sync	Flash exposure compensation	Cancelled
Function	Condition																
Focus area	Centre																
Flexible Program	Cancelled																
Exposure compensation	Cancelled																
Auto Exposure Lock	Cancelled																
Auto Exposure Bracketing	Cancelled																
Flash Sync mode	Front-curtain sync																
Flash exposure compensation	Cancelled																
"CSM"	<ul style="list-style-type: none"> <li>● All the custom settings are reset.</li> <li>● The ISO sensitivity is reset to 200.</li> </ul>																

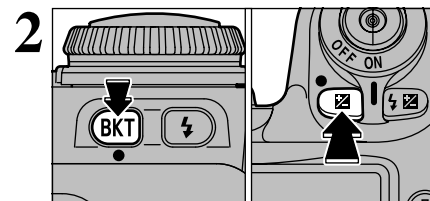

Hold down the "BKT" and "Z" buttons together for at least 2 seconds (green markings are positioned alongside). The top display panel flashes briefly and the settings are reset.

3 When the reset is finished, set the exposure mode dial to a setting other than "CSM".



## CUSTOM SETTING (CSM)

The custom settings allow to modify camera functions such as how information is displayed in the viewfinder and which functions are assigned to which buttons.

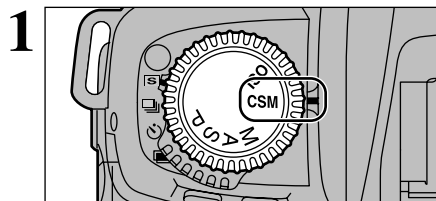

Set the exposure mode dial to “CSM”.

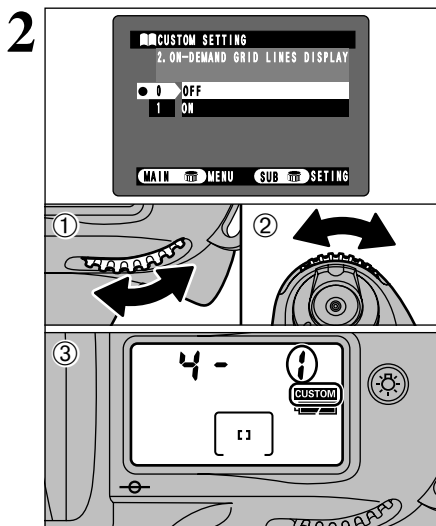

- ① Turn the main-command dial to select an option.
- ② Turn the sub-command dial to change the setting.
- ③ “CUSTOM” appears on the top display panel.

3 When you have finished the settings, set the exposure mode dial to a setting other than “CSM”.

⚡ The custom settings are retained when the camera is switched off.

### Cancelling custom settings

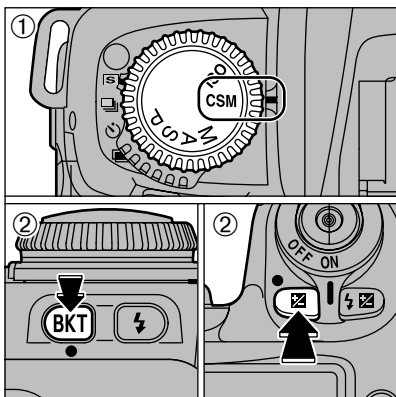

- ① Set the exposure mode dial to “CSM”.
  - ② Hold down the “BKT” and “AF-ON” buttons together for at least 2 seconds (green markings are positioned alongside).  
The top display panel flashes briefly and the settings are reset.
- All the custom settings are reset to their default values.
  - The ISO sensitivity is reset to 200.

### Custom Settings List

No.	Setting	Display	Details
1	BRACKETING ORDER	0: METERED VALUE ➔ UNDER ➔ OVER (default) 1: UNDER ➔ METERED VALUE ➔ OVER	Allows you to change the compensation sequence when auto exposure bracketing is used.
2	ON-DEMAND GRID LINES DISPLAY	0: OFF (default) 1: ON	If you display the framing guides, you can use the intersections of the horizontal and vertical lines to position your main subject in the shot or align one of the horizontal lines with the horizon. This allows you to compose the desired shot while monitoring the subject's size and the balance.
3	ILLUMINATION FOR FOCUS AREA	0: AUTO (default) 1: OFF 2: ON	Specifies the illumination used for the focus area in the viewfinder.
4	FOCUS AREA SELECTION	0: NORMAL (default) 1: ENABLES ROTATION	Selecting cyclic focus area selection allows you to select the opposite focus area without changing which part of the 4-direction button you have to press.
5	AE-LOCK	0: DISABLED (default) 1: ACTIVATED	This setting lets you apply AE lock by pressing the shutter button down halfway.
6	LONG EXP. (BULB) AT MANUAL MODE	0: DISABLED (default) 1: ACTIVATED	Select “1” to take bulb flash shots in the “M” exposure mode.
7	CLOSEST-SUBJECT-PRIORITY DYNAMIC AF AT S-AF MODE	0: ENABLED (default) 1: DISABLED	If you select “1”, Closest-subject Priority Dynamic AF is not used in AF-S mode.
8	CLOSEST-SUBJECT-PRIORITY DYNAMIC AF AT C-AF MODE	0: DISABLED (default) 1: ENABLED	If you select “1”, Closest-subject Priority Dynamic AF is used in AF-C mode.
9	AE/AF LOCK BUTTON	0: AE/AF LOCK (default) 1: AE LOCK ONLY 2: AF LOCK ONLY 3: AE REMAINS LOCKED 4: AF OPERATION	Normally, AE lock (exposure recording) and AF lock (focus lock) are both applied concurrently when you press the “AE-L/AF-L” button. However, this can be changed so that only AE lock or only AF lock is applied, or so that the AE lock status is maintained. If the AE/AF lock is used with the “Maintain AE lock” setting, pressing the “AE-L/AF-L” button again or releasing the shutter cancels the lock. In addition, though the auto focus (AF) normally operates when the shutter button is pressed down halfway, you can change this so that AF operates when the “AE-L/AF-L” button is pressed. (In this case, AF does not operate when the shutter button is pressed down halfway.)
10	COMMAND DIAL FUNCTIONS	0: DISABLED (default) 1: ENABLED	Use this setting to change the main command dial and sub-command dial operation during photography. 0: Main: Changes the shutter speed. Sub: Changes the aperture. 1: Main: Changes the aperture. Sub: Changes the shutter speed.
11	MULTIPLE EXPOSURE	0: SINGLE SHUTTER RELEASE (default) 1: CONTINUOUS SHUTTER RELEASE	Changing this setting allows you to use continuous shooting for multi-exposure shots.

## CUSTOM SETTING

No.	Setting	Display	Details
12	AUTO POWER OFF	0: OFF 15: 15 SEC. (default) 2: 2 MIN. 5: 5 MIN.	Sets the delay time until the Auto Power Off function operates. Preview image display is also cancelled after the specified time.
13	SELF-TIMER DURATION	2: 2 SEC. 5: 5 SEC. 10: 10 SEC. (default) 20: 20 SEC.	Sets the running time for the self timer.
14	LCD ILLUMINATION	0: OFF (default) 5: 5 SEC. 15: 15 SEC.	Allows you to change the settings so that the LCD illumination lights when buttons are used.
15	AF-ASSIST ILLUMINATOR	0: ON (default) 1: OFF	Allows you to prevent the built-in auxiliary AF light from operating. Note that this may prevent the auto focus from successfully setting the focus in some cases.

## 6 Connection

## CONNECTING TO A TV/ USING THE AC POWER ADAPTER (OPTIONAL)

### Connecting to a TV

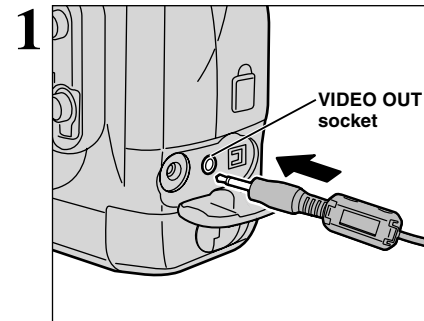

Switch off the camera and TV. Open the terminal cover and plug the bundled video cable into the camera's "VIDEO OUT" socket.

⚠ If there is a power outlet available, connect the AC-5VH/AC-5VHS AC Power Adapter.

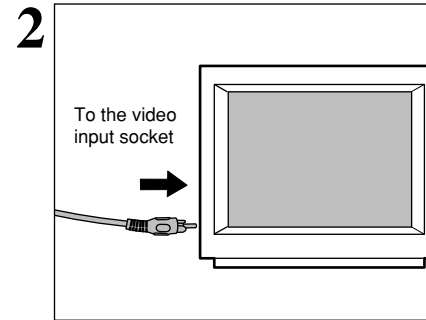

Plug the other end of the cable into the video input socket on the TV. Then switch the camera and TV on and take pictures or play back images as you would normally.

⚠ Refer to the instructions provided with your TV for more information on video input for your TV.

### Using the AC Power Adapter (OPTIONAL)

The AC Power Adapter is useful since it allows you to take pictures, play back images (connected to a TV, etc.) and connect to a computer without worrying about using up the battery charge.

#### • Compatible AC power adapters

Model: AC-5VH/AC-5VHS (optional)

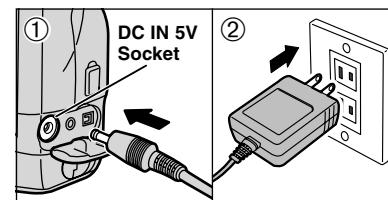

Check that the camera is switched off and then remove the lithium batteries. Open the terminal cover and plug the AC power adapter connector into the "DC IN 5V" socket. Then plug the AC power adapter into a power outlet.

- ⚠ Use only the FUJIFILM products listed above.
- ⚠ See P.112 for notes on using the AC power adapter.
- ⚠ The shape of the plug and socket-outlet depends on the country of use.
- ⚠ The lithium batteries are still used when the AC power adapter is connected.
- ⚠ The built-in flash will not operate if the lithium batteries are removed.

# CONNECTING TO A COMPUTER

Install the software before connecting the camera to a computer.  
The available functions differ depending on the camera's PC mode settings, as shown below.

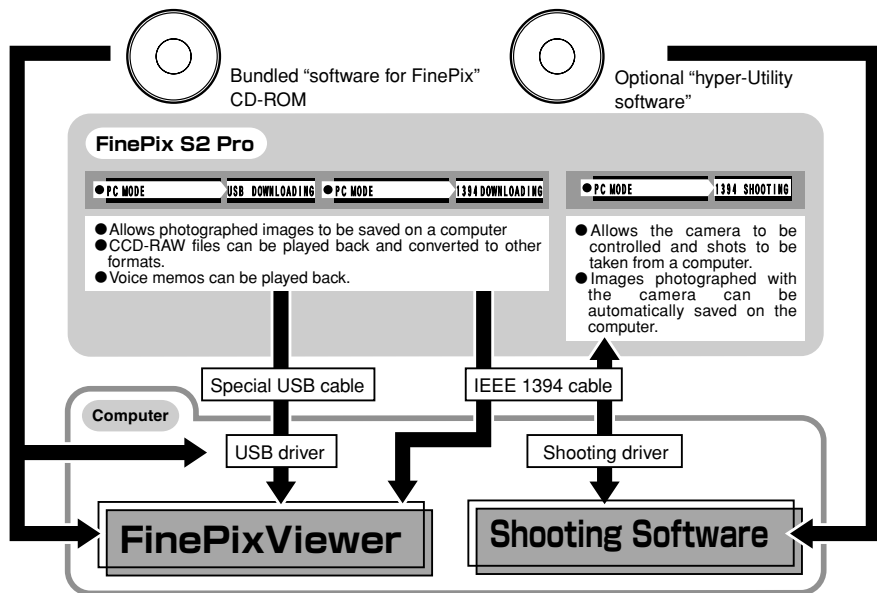

- Refer to the User's Guide for the optional Hyper-Utility Software HS-S2 for more information on the photography modes.
- This description covers the downloading modes.

## Connecting to a Computer

To connect the camera to a computer via a USB port, the computer must be equipped with a USB port as a standard feature. (Operation is not guaranteed for USB ports added later.) To connect via an IEEE1394 port, check that the interface is OHCI compliant and then refer to the table below to check whether it is supported by your operating system.

### Operating System Compatibility Chart (Windows)

○: Can be connected X: Cannot be connected

Connection type	OS				
	Windows 98	Windows 98 SE (Second Edition)	Windows Me (Millennium Edition)	Windows 2000	Windows XP
IEEE1394	X	○*2	○	○	○
USB*1	○	○	○	○	○

\*1 Can be used by installing the driver from the bundled CD-ROM.

\*2 Select Windows Update from the Start button menu and update the 1394 device driver (Your system must be capable of connecting to the Internet).

### Operating System Compatibility Chart (Macintosh)

○: Can be connected X: Cannot be connected

Connection type	OS				
	Mac OS 8.6	Mac OS 9.0.4	Mac OS 9.1	Mac OS 9.2.1	Mac OS X
IEEE1394	X	X*2	○	○	○
USB*1	○	○	○	○	○

\*1 Can be used by installing the driver from the bundled CD-ROM.

\*2 Cannot be used even when installed as a standard feature, but can be used by downloading and installing the free update to Mac OS 9.1. Contact Apple Computers (<http://www.apple.com>) for information on software updates.

# CONNECTING TO A COMPUTER VIA IEEE 1394

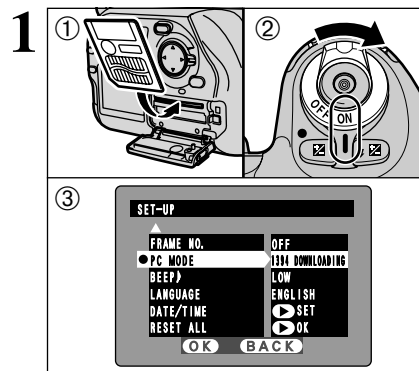

- Load the media containing your shots into the camera.
- Switch the camera on.
- Select "1394 DOWNLOADING" as the "PC MODE" setting in SET-UP (→P.89).
- Set the power switch to "OFF" to switch the camera off.

- Refer to the operating system compatibility charts on P.100 and check that your operating system supports the IEEE1394 interface.
- Use of the AC power adapter (sold separately) is recommended when connecting the camera to a computer.
- If a SmartMedia and Microdrive are both loaded into the camera at the same time, the media selected in the "MEDIA" setting in SET-UP is used (→"Setup", P.89).

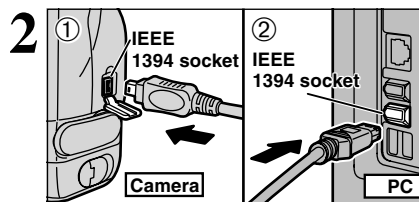

- Switch your PC on.
- Connect the camera to the computer using the bundled IEEE1394 cable.
- Switch the camera on.

Always use the prescribed procedure when disconnecting or switching off the camera (→P.103).

- In Windows XP and Mac OS X, automatic startup must be set up the first time you connect.
- The first time you connect, the media may take a few moments to mount.
- Take care to ensure that the cable is connected the right way round and that the plugs are firmly inserted all the way into the sockets.

## Camera Operations

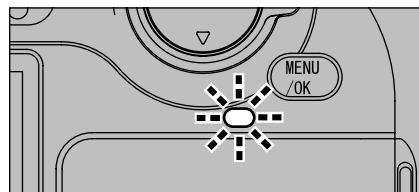

- The Access lamp blinks when the camera and computer are exchanging data.
- "1394 DOWNLOADING" is displayed on rear display panel.
- The Auto Power Off function is disabled while the camera is connected to a computer.

- When replacing the media, always switch the camera and computer off first using the procedure described on P.103.
- Do not disconnect the USB cable when the camera is communicating with the PC. See P.103 for information on the disconnection procedure.

## PC Operations

- If FinePixViewer is installed, it starts up automatically.



\* Screen for Windows 98 SE

- A removable disk icon appears and you can use your PC to transfer files to and from the camera.

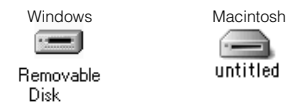

If the above operations do not occur, you do not have the required software programs or drivers installed on your PC. Refer to the Software Quick Start Guide booklet and complete the required PC setup procedures. Then reconnect the camera to your PC.

## CONNECTING TO A COMPUTER VIA USB

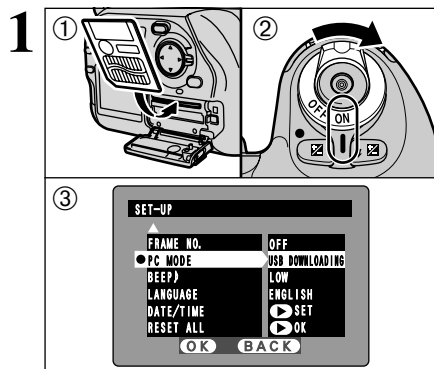

- 1 Load a media containing photographed images into the camera.
  - 2 Switch the camera on.
  - 3 Select "USB DOWNLOADING" as the "PC MODE" setting in SET-UP (→P.89).
  - 4 Set the power switch to "OFF" to switch the camera off.
- ⚡ Before connecting, you must install software on the bundled CD-ROM on your computer.
  - ⚡ Use of the AC power adapter (sold separately) is recommended when connecting the camera to a computer.
  - ⚡ If a SmartMedia and Microdrive are both loaded into the camera at the same time, the media selected in the "MEDIA" setting in SET-UP is used (→"Setup", P.89).

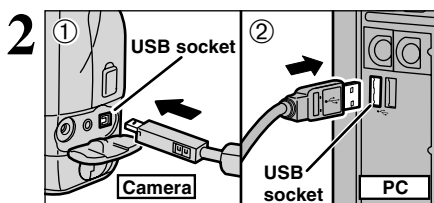

- 1 Switch your PC on.
- 2 Connect the special USB cable to the camera and the computer.
- 3 Switch the camera on.

Always use the prescribed procedure when disconnecting or switching off the camera (→P.103).

- ⚡ In Windows XP and Mac OS X, automatic startup must be set up the first time you connect.
- ⚡ Take care to ensure that the cable is connected the right way round and that the plugs are firmly inserted all the way into the sockets.

If you are using a Windows PC, the driver settings are automatically specified when installation ends. Simply wait a few moments.

\* If your computer does not recognize the camera, refer to the Software Quick Start Guide.

### Camera Operations

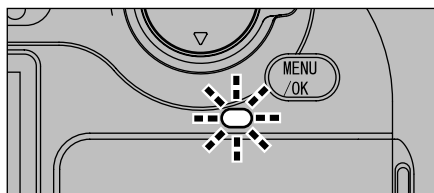

- When the camera and the computer are exchanging data, the Access lamp blinks orange.
- "USB DOWNLOADING" is displayed on the rear display panel.
- The Auto Power Off function is disabled while the camera is connected to a computer.
- ⚡ When replacing the SmartMedia, always disconnect the camera and computer first using the procedure described on P.103.
- ⚡ Do not disconnect the USB cable during communication. See P.103 for the disconnection instructions.

### PC Operations

- If FinePixViewer is installed, it starts up automatically.
- A removable disk icon appears and you can use your PC to transfer files to and from the camera.

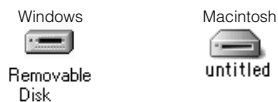

If the above operations do not occur, you do not have the required software programs or drivers installed on your PC. Refer to the Software Quick Start Guide booklet and complete the required PC setup procedures. Then reconnect the camera to your PC.

## DISCONNECTING FROM THE PC (Important — always use this procedure.)

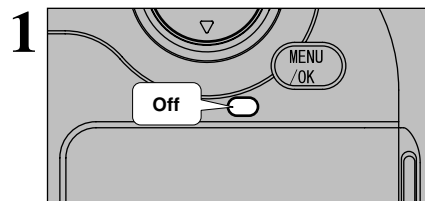

- 1 Quit all applications (FinePixViewer, etc.) that are using the camera.
- 2 Check that the Access lamp is off (that the camera and computer are no longer exchanging data).

⚡ In some cases, the camera and computer may still be communicating even after the "Copying" message disappears from the computer screen. Always check that the Access lamp is off.

- 2 Perform the steps shown below before you switch the camera off. This procedure differs depending on the operating system software (or PC) you are using.

### Windows 98/98 SE

For a USB connection, no action is needed on the computer. If you are connecting via an IEEE1394 interface, use the disconnection procedure described below.

- 1 Left-click the Eject icon in the taskbar and eject "USB Disk".
- 2 The "Eject" menu option is displayed. Click this menu option.
- 3 The "Eject hardware" dialog box appears. Click the [OK] button or the close button.

### Windows Me/2000 Professional/XP

- 1 Right-click the removable disk icon in the "My Computer" window and select Eject.
- 2 Left-click the Eject icon in the taskbar and eject "USB Disk".

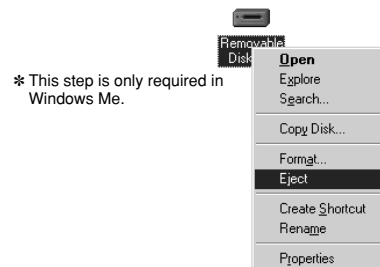

\* This step is only required in Windows Me.



\* Windows Me screen

- 3 The "Eject" menu option is displayed. Click this menu option.
- 4 The "Eject hardware" dialog box appears. Click the [OK] button or the close button.

### Macintosh

Drag the "Removable drive" icon on the desktop to the Trash.



⚡ When you drag the icon to the Trash, "REMOVE OK" appears on the camera's screen.

- 3 Switch the camera off and disconnect the IEEE1394 or USB cable.

## System Expansion Options

► By using the FinePix S2 Pro together with other optional FUJIFILM products, your system can be expanded to fill a wide range of uses.

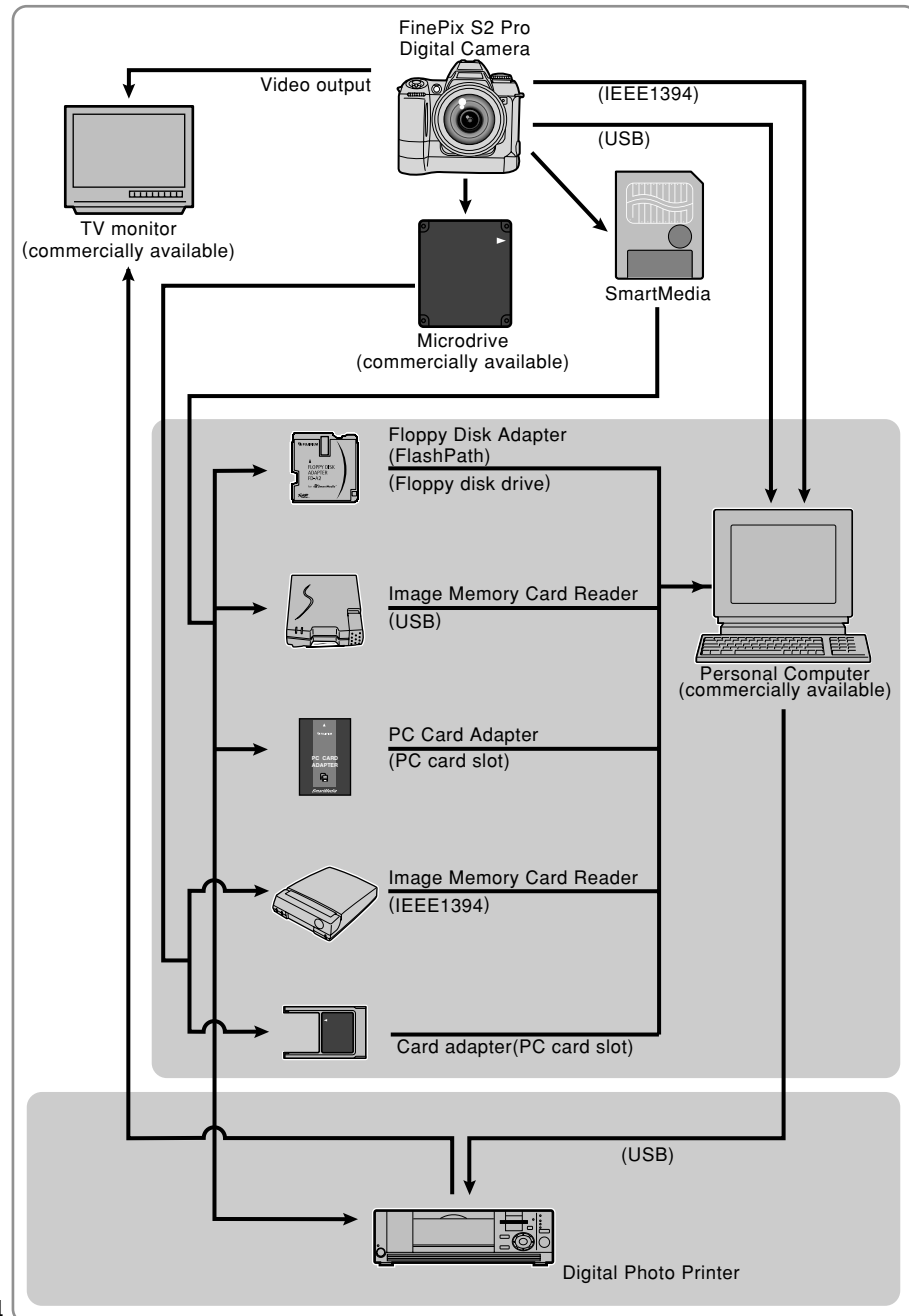

## Accessories Guide

► The optional accessories (sold separately) can make taking pictures with the FinePix S2 Pro even easier. For information on how to attach and use the accessories, refer to the instructions provided with the accessory used.

Visit the FUJIFILM web site for the latest information on camera accessories. <http://home.fujifilm.com/products/digital/index.html>

### ● SmartMedia™

- These are SmartMedia cards sold separately. Use the 9 types listed below.
- MG-4S : 4MB, 3.3V
  - MG-8S : 8MB, 3.3V
  - MG-16S : 16MB, 3.3V
  - MG-32S : 32MB, 3.3V
  - MG-64S : 64MB, 3.3V
- \* Some 3.3V SmartMedia are labelled as "3V" cards.
- MG-16SW : 16MB, 3.3V, ID
  - MG-32SW : 32MB, 3.3V, ID
  - MG-64SW : 64MB, 3.3V, ID
  - MG-128SW : 128MB, 3.3V, ID
- \* SmartMedia with ID are labelled as "ID" cards.

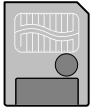

### ● AC-5VH/AC-5VHS AC Power Adapter

- Use the AC-5VH/AC-5VHS when you want to take pictures or play back images for long periods or when the FinePix S2 Pro is connected to a personal computer.
- \* The shape of the AC power adapter, the plug and socket outlet depend on the country.

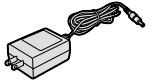

### ● Fujifilm Rechargeable Battery 2HR-3UF

- The 2HR-3UF includes high-capacity AA-size Nickel-Metal Hydride batteries.



### ● Fujifilm Battery Charger with Battery BK-NH (Not Available in U.S.A. / Canada)

- The BK-NH includes the quick battery charger BCH-NH and 2 AA Ni-MH batteries. The BCH-NH can charge 4 AA Ni-MH batteries in approx. 180 minutes.
- Up to 4 Ni-MH or Ni-Cd batteries can be charged simultaneously.

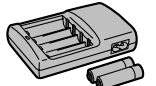

### ● SM-R2 Image Memory Card Reader

- The SM-R2 allows images to very easily be read and written from an image memory card (SmartMedia) to a personal computer. Its USB interface provides high-speed data transmission.
- Compatible with Windows 98 SE, Windows Me, Windows 2000 Professional or iMac or Power Macintosh and models that support USB as standard.

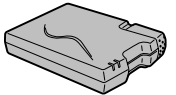

### ● DM-R1 Image Memory Card Reader

- This device provides a simple way to transfer image data in either direction between your PC and an image memory card (SmartMedia or CompactFlash Type II (Microdrive-compatible)).
- The IEEE 1394 interface provides high-speed data transfer.
- Compatible with Windows 98 SE, Windows 2000 Professional (read-only), iMac DV and Power Macintosh PCs with FireWire as a standard feature. Mac OS 8.5.1 to 9.1

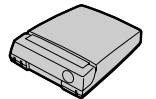

### ● PC-AD3 PC Card Adapter

- The PC Card Adapter allows the SmartMedia to be used as a PC Card Standard ATA-compliant (PCMCIA 2.1) PC card (Type II).
- Compatible with SmartMedia of 5V/3.3V, 2MB to 128MB.



### ● Hyper-Utility Software HS-S2 (IEEE1394 Interface)

- This software allows you to convert CCD-RAW files shot on the FinePix S2 Pro to 16-bit TIFF files by specifying the conversion settings (tone curve, white balance, sharpness and color) and the output image size.
- This software also makes it possible for you to connect the camera to a computer via an IEEE1394 interface and download the images shot on the camera directly to the computer without first storing them on a media. You can also use this software to control the camera and take pictures from your computer.
- This software allows images shot on the Digital Camera FinePix S2 Pro to be used on a computer.

#### ■ System Requirements

	Windows®	Mac OS
Compatible machine	IBM PC/AT compatible PC	Macintosh with an IEEE1394 interface as a standard feature
Connection ports (only when photography software is used)	Equipped with an IEEE1394 (OHCI-compliant) PCI board or IEEE1394 (OHCI-compliant) CardBus card	IEEE1394 port as a standard feature
Operating system	Windows® Me, 2000 Professional, XP	Mac OS 9.1 to 9.2
CPU	Pentium III, 4 or Celeron or higher	PowerPC G3, G4, iBook (Dual USB)
RAM	RAM of 256 MB or more (512 MB recommended)	RAM of 256 MB or more (512 MB recommended)
Hard disk	Minimum 1 GB available space	Minimum 1 GB available space
Display Monitor	1024 × 768 pixels or higher, High Color (16-bit) or higher	1024 × 768 pixels or higher, approx. 32,000 color or higher
Disk drives	Drive capable of reading CD-ROM disks	Drive capable of reading CD-ROM disks

► Be sure to read this information in conjunction with “Safety Notes” (→P.123), to ensure that you use your camera correctly.

### ■ Places to Avoid

Do not store or use the camera in the following types of locations:

- In the rain or in very humid, dirty or dusty places.
- In direct sunlight or in places subject to extreme temperature rises, such as in a closed car in summer.
- Extremely cold places.
- Places subject to strong vibration.
- Places affected by smoke or steam.
- Places subject to strong magnetic fields (such as near motors, transformers or magnets).
- In contact with chemicals such as pesticides or next to rubber or vinyl products for long periods of time.

### ■ Notes on Immersion in Water or Sand

The FinePix S2 Pro is particularly adversely affected by water and sand. When you are at the beach or close to water, ensure that the camera is not exposed to water or sand. Take care also not to place the camera on a wet surface. Water or sand inside the camera can cause faults that may be irreparable.

### ■ Notes on Condensation

If the camera is carried suddenly from a cold location into a warm place, water droplets (condensation) may form on the inside of the camera or on the lens. When this occurs, switch the camera off and wait an hour before using the camera. Condensation may also form on the media. In this event, remove the media and wait a short time before using it again.

### ■ When the Camera is Unused for Long Periods

If you do not intend to use the camera for a long period of time, remove the battery and the media card before storing the camera.

### ■ Cleaning Your Camera

- Use a blower brush to brush away any dust on the lens, LCD monitor surface, viewfinder or external AF sensor and then gently wipe the camera with a soft, dry cloth. If any soiling remains, apply a small amount of lens cleaning liquid to a piece of FUJIFILM lens cleaning paper and wipe gently.
- Do not scratch hard objects against the lens, LCD monitor screen or viewfinder as these surfaces are easily damaged.
- Clean the body of the camera with a soft, dry cloth. Do not use volatile substances such as thinners, benzene or insecticide, as these may react with camera body and cause deformation or remove the coating.
- This camera is equipped with a CCD photosensitive element. This CCD is located behind the shutter screen. If dust or other soiling attaches to the surface of the CCD and pictures are then taken, this soiling may appear as spots in the image, depending on the camera settings and the type of subject. If this occurs, the CCD must be cleaned. Because the surface of the CCD is extremely fragile, wherever possible the camera should be returned to an authorized FUJIFILM dealer for cleaning (for a charge). Any repairs carried out by an authorized FUJIFILM service facility to CCDs that were scratched or damaged during cleaning by the customer will be charged to the customer. Note that such repairs will probably involve replacing the CCD and will be expensive.

⚠ Take the following precautions to ensure that no dirt or dust gets onto the CCD:

- Before a FUJIFILM digital camera is shipped from the factory, it is carefully checked for dust inside the camera and on the surface of the CCD to ensure that it conforms to FUJIFILM standards.
- Bear in mind also that some types of soiling on the CCD surface cannot be removed even by an authorized FUJIFILM service facility. Should this occur, you can use features such as the despeckling function provided in the image processing software to remedy the problem.

### ■ Using the Camera Overseas

When travelling overseas, do not place your camera in the check-in baggage. Baggage handling at airports may subject baggage to violent shocks, and the camera may be damaged internally even when no external damage is visible.

# Cleaning the CCD

This camera is equipped with a CCD photosensitive element. This CCD is located behind the shutter screen.

If dust or other soiling attaches to the surface of the CCD and pictures are then taken, this soiling may appear as spots in the image, depending on the camera settings and the type of subject. If this occurs, the CCD must be cleaned. Because the surface of the CCD is extremely fragile, wherever possible the camera should be returned to an authorized FUJIFILM dealer for cleaning (for a charge).

Any repairs carried out by an authorized FUJIFILM service facility to CCDs that were scratched or damaged during cleaning by the customer will be charged to the customer. Note that such repairs will probably involve replacing the CCD and will be expensive.

## ◆ Dust inside the camera and on the surface of the CCD ◆

- Before a FUJIFILM digital camera is shipped from the factory, it is carefully checked for dust inside the camera and on the surface of the CCD to ensure that it conforms to FUJIFILM standards.
- Bear in mind also that some types of soiling on the CCD surface cannot be removed even by an authorized FUJIFILM service facility. Should this occur, you can use features such as the despeckling function provided in the image processing software to remedy the problem.

## Checking the Condition of the CCD Surface

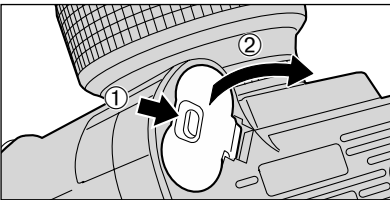
**1**  Check that the camera is switched off and then remove the lithium batteries.

⚠ Do not apply excessive force to the battery cover.

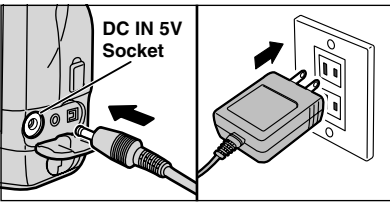
**2**  Open the terminal cover and fully insert the connector plug from the AC power adapter (sold separately) into the "DC IN 5V" socket. Then plug the AC power adapter into the power outlet.

⚠ When cleaning the camera, always use the AC power adapter (sold separately) to prevent camera damage due to the mirror dropping down or the shutter closing.

⚠ See P.112 for more information on using the AC power adapter.

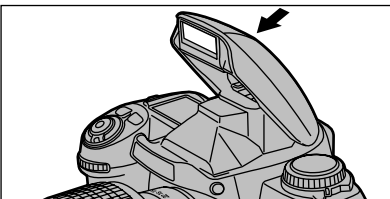
**3**  Press the built-in flash down to stow it away.

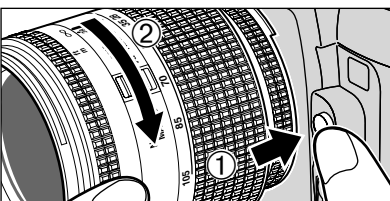
**4**  Hold down the lens release button and turn the lens in the direction of the arrow.

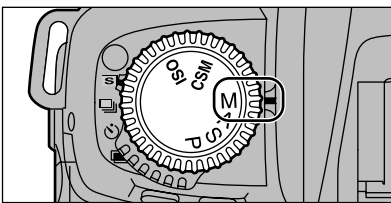
**5**  Set the exposure mode dial to "M".

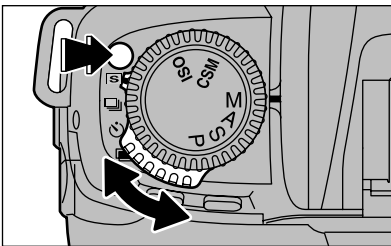
**6**  Hold down the release mode switch unlock button and set the release mode switch to "S" (single-frame).

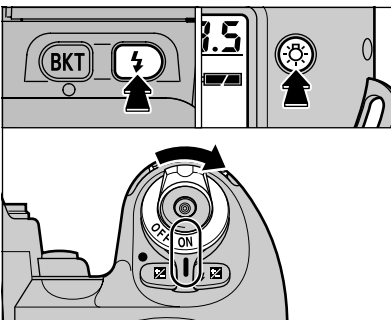
**7**  Hold down both the Synchro mode button and the LCD illumination button and switch the camera on.

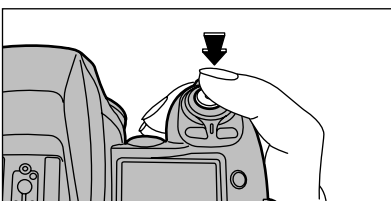
**8**  When you press the shutter button, the mirror flips up and the shutter opens and stays open.

⚠ When you release the shutter button, the mirror stays up.

## Cleaning the CCD

9 Hold the camera so that the sun shines on the CCD and check the surface for dust.

Surface clean

Surface soiled

Contact a FUJIFILM service center and request CCD cleaning.

Clean the CCD yourself.

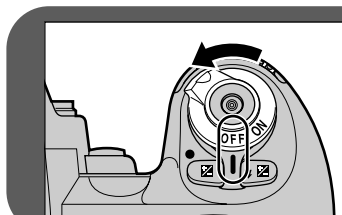

Switch the camera off and attach a lens or body cap to the camera.

⚠ When you switch the camera off, the mirror drops down and the shutter closes at the same time. Ensure that your fingers are not caught inside the camera.

### Starting CCD Cleaning

Take great care to avoid scratching or damaging the CCD during cleaning, as you will be responsible for the possibly high cost of repairs (or replacement) by an authorized FUJIFILM service facility.

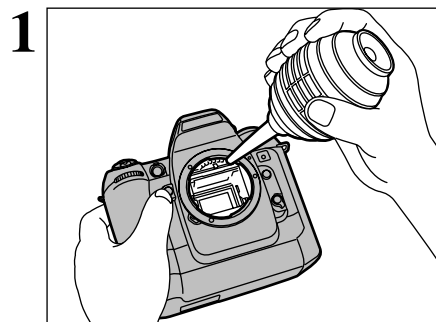

1 Use a blower (without a brush attached) to remove any soiling on the CCD surface.

⚠ Use a blower that does not have a brush attached. Using a blower brush to clean soiling from the CCD can scratch the CCD surface.

2 Check whether the dust has been removed from the CCD surface.

The blower has removed the dust (There are no oily marks or fingerprints).

There are oily marks or fingerprints left on the CCD that cannot be removed with the blower.

Proceed to step 3.

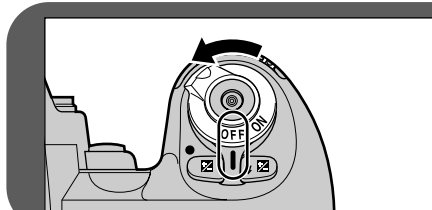

Switch the camera off and mount the lens or body cap on the camera.

⚠ When you switch the camera off, the mirror drops down and the shutter closes at the same time. Ensure that your fingers are not caught inside the camera.

### ◆ Ensure that you have the cleaning equipment ready ◆

- Cleaning swabs  
Sensor Swab (Photographic Solutions, Inc.)  
\* For information on suppliers outside Japan, visit the web site listed below (<http://www.photosol.com/swabproduct.htm>).
- Cleaning fluid  
Ethanol (95% solution or better), EE Cleaner (Olympus)

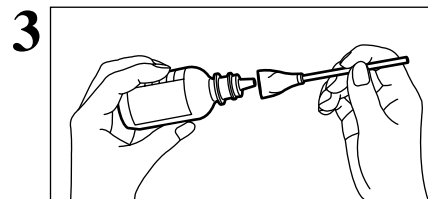

3 Moisten the bottom 5 mm of the Sensor swab evenly with cleaning fluid.

⚠ Do not use the swab when it is dry or not moistened with cleaning fluid.

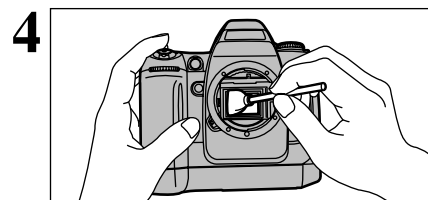

4 Slowly and gently wipe one side of the swab just once across the full width of the CCD from left to right.

5 Then wipe the other side of the Sensor swab across the full width of the CCD from left to right once more. Do not reuse Sensor swabs.

If this does not remove the soiling, repeat steps 3 to 5 with a new Sensor swab or contact an authorized FUJIFILM service facility.

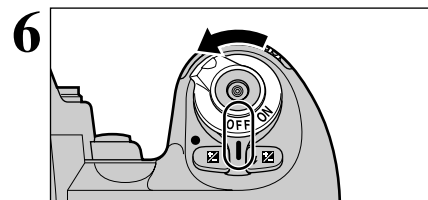

6 Switch the camera off and mount the lens or body cap on the camera.

⚠ When you switch the camera off, the mirror drops down and the shutter closes at the same time. Take care to ensure that your fingers are not caught inside the camera.



# Notes on the Power Supply

## Applicable Batteries

● Use AA-size alkaline or nickel-metal hydride (Ni-MH) batteries, and 3-volt lithium batteries with this camera. AA-size manganese or lithium batteries cannot be used.

● The operating lives of alkaline batteries vary between brands and the life of batteries you purchase may be shorter than the alkaline batteries provided with the camera.

## Notes on the Batteries

Incorrect use of the batteries could cause them to leak, become hot, ignite or burst. Always observe the precautions given below.

- Do not heat the batteries or throw them into a fire.
- Do not carry or store the batteries with metal objects such as necklaces or hairpins that could come into contact with the metal positive (+) and negative (-) poles of the battery.
- Do not expose the batteries to fresh or sea water, and take particular care to keep the terminals dry.
- Do not attempt to deform, disassemble or modify the batteries.
- Do not attempt to peel off or cut the battery casing.
- Do not drop, strike or otherwise subject the batteries to strong impacts.
- Do not use the batteries that are leaking, deformed, discolored or exhibit any other obvious abnormality.
- Do not store the batteries in very warm or moist locations.
- Keep the batteries out of reach of infant and young children.
- When loading the batteries into the camera, ensure that the battery polarity (+) and (-) is as indicated on the camera.
- Do not use new batteries together with used batteries. In the case of rechargeable batteries, do not use charged and discharged batteries together. Do not use batteries of different types or brands together.
- If you do not intend to use the camera for a long period of time, remove the batteries from the camera (Note that if the camera is left with the batteries removed, the time and date settings are cleared).
- The batteries may feel warm immediately after being used. Before removing the batteries, switch the camera off and wait until the batteries cool down.
- When replacing the batteries, always fit 4 new batteries. Here, "new batteries" refers to either recently purchased unused alkaline batteries, or Ni-MH (nickel metal hydride) batteries that have recently been fully recharged together.
- In cold locations (at temperatures of +10°C/+50°F or below), battery performance deteriorates and the time for which they can be used shortens markedly. This is particularly true of alkaline batteries. In cold conditions, put the batteries in your pocket or a similar place to warm them before loading them into the camera. If you use a body warmer to warm the batteries, ensure that they are not in direct contact with the warmer.
- Soil (such as fingerprints) on the battery terminals can markedly reduce the number of available shots. Carefully wipe the battery terminals clean with a soft dry cloth before loading the batteries.

- ⚠ If any liquid at all leaks from the batteries, wipe the battery compartment thoroughly and then load new batteries.
- ⚠ If any battery fluid comes into contact with your hands or clothing, flush the area thoroughly with water. Note that battery fluid can cause loss of eyesight if it gets into your eyes. If this occurs, do not rub your eyes. Flush the fluid out with clean water and contact your physician for treatment.

## Notes on Using the AC Power Adapter

Always use the AC-5VH/AC-5VHS AC Power Adapter with the camera.

The use of an AC Power adapter other than AC-5VH/AC-5VHS could result in damage to your digital camera.

- This AC power adapter is designed exclusively for indoor use.
- Plug the connection cord plug securely into the DC input terminal of the FUJIFILM Digital camera.
- Turn off the power switch of the FUJIFILM Digital camera before disconnecting the connection cord from the FUJIFILM Digital camera's DC input terminal. To disconnect, take hold of the plug and pull it out (do not disconnect it by pulling on the cord).

### Disposing of Batteries

When disposing of batteries, do so in accordance with your local waste disposal regulations.

### Notes on Small Rechargeable Batteries (Ni-MH batteries)

- Always use the special battery charger to charge AA-size Ni-MH batteries. Charge the batteries as described in the instructions provided with the battery charger.
- Do not use the battery charger to charge batteries other than those specified for use with the charger.
- Note that the batteries may feel warm immediately after being charged.
- Ni-MH batteries are not charged at shipment. Be sure to charge the batteries before using them.
- The camera mechanism is such that it draws a minute amount of current even when the camera is switched off. Take particular care not to leave Ni-MH batteries in the camera for a long period of time as they can become excessively discharged and may no longer be usable even when charged.
- Ni-MH batteries self-discharge even when not used. Always charge Ni-MH batteries before using them. If the time for which a battery provides power shortens markedly when it has been correctly charged, this indicates that the battery has reached the end of its effective life and should be replaced.
- Soiling (fingerprints, etc) on the terminals of Ni-MH batteries can greatly reduce the number of available shots. When this occurs, clean the terminals carefully with a soft dry cloth. Then use up the remaining charge in the batteries and recharge them.
- Newly purchased batteries or batteries that have been left unused for an extended period may not be fully charged. (This is indicated by the immediate display of the battery low warning or a low number of available shots.) This is a normal characteristic of the batteries and does not indicate a fault. Repeatedly charging and using the batteries 3 or 4 times will restore them to a normal condition.
- If you repeatedly charge a Ni-MH battery before it is fully discharged, it will suffer from the "memory effect", causing the battery low warning to appear while there is still ample charge remaining in the battery. To restore the batteries to their normal condition, use up all the charge in the batteries before recharging them.
- \* Memory effect: A phenomenon affecting the battery characteristics such that the apparent battery capacity decreases.

- Do not use this AC power adapter with any device except the specified device.
- During use, this AC power adapter will become hot to touch, but this is normal.
- Do not disassemble the AC power adapter. Doing so could be dangerous.
- Do not use this device in a place with high temperature and high humidity.
- Do not drop or subject this device to strong shocks.
- This device may emit a humming noise, but this is normal.
- If used near a radio, this device may cause static, so play the radio in a distant place.

# Notes on the Media (SmartMedia™ and Microdrives)

### SmartMedia

The SmartMedia card is a new image recording medium developed especially for use in digital cameras. Each SmartMedia card contains a built-in semiconductor memory chip (NAND flash memory) which is used for storing image data files in digital form. Because the data is stored electronically, the stored image data can be erased from the card and new data recorded.

### SmartMedia with ID

A SmartMedia with ID is a SmartMedia that has an individually assigned identification number. SmartMedia ID cards can be used with devices that use ID numbers for copyright protection or other purposes. This camera accepts SmartMedia ID cards in the same way as conventional SmartMedia cards.

### Microdrives

Microdrives are compact, lightweight hard disk drives that conform to the CF+ Type II standard. Due to their ample capacity for large image data files and their low per-megabyte recording cost, Microdrives provide a more economical way to save high-resolution image files.

### Storing Data

In the situations listed below, recorded data may be erased (destroyed). Please note that FUJIFILM accepts no responsibility whatsoever for the loss (destruction) of recorded data.

- \* When the media is used incorrectly by the owner or a third party
- \* When the media is exposed to static electricity or electrical noise
- \* When the media is removed or the camera is switched off during data recording or erasing (media formatting)
- \* When the media is bent, dropped or otherwise subjected to a strong force or impact

Important data should be backed up onto another medium. (MO disk, floppy disk, hard disk, etc.)

### General Notes on Handling Media (all types)

- When inserting the media into the camera, hold the media straight as you push it in.
- Never remove the media or switch the camera off during data recording or erasing (media formatting) as this could result in damage to the media.
- Data storage media are precision electronic devices. Do not bend, drop or otherwise subject the media to strong force or shocks.
- Do not use or store these media in environments likely to be affected by strong static electricity or electrical noise.
- Do not use or store media in locations subject to high temperatures and humidity or in environments where they are exposed to corrosive substances.

### Notes on Handling SmartMedia

- Use only the SmartMedia specified for use with the camera. The use of other SmartMedia could damage the camera.
- Take care not to touch the SmartMedia's contact area (the gold-colored area) or allow the area to become soiled. Use a soft, dry cloth to wipe off any soiling that does occur.
- To avoid damage caused by static electricity, always use the special static-free case provided when carrying or storing the media. Alternatively, keep the SmartMedia in a storage case if available.
- Inserting a SmartMedia that is charged with static electricity into your camera may result in a camera malfunction. If this occurs, switch the camera off and then on again.
- Do not carry SmartMedia in locations such as a trouser pocket. This could subject the SmartMedia to excessive force when you sit down, thereby damaging the

SmartMedia.

- The SmartMedia may feel warm when it is removed from the camera after extended periods of use. This is normal and does not indicate a fault.
- SmartMedia have a limited life and it may become impossible to record or erase data on a SmartMedia that has been used for a long time. When this happens, purchase a new SmartMedia.
- Affix the index labels supplied with the SmartMedia onto the designated area of the card. Do not use third-party labels as this can lead to problems when the card is inserted or removed.
- When you attach the index label to a SmartMedia, take care that it does not cover any part of the write-protect area.

### Notes on using Microdrive

- Do not write on the Microdrive label.
- Do not peel off the Microdrive label.
- Do not stick additional labels onto a Microdrive.
- When carrying or storing a Microdrive, keep it in the protective case provided.
- Do not use Microdrive in CF+ Type II slots that do not have an eject function.
- Take care when handling Microdrive that have been used for long periods as they may become hot.
- Do not place Microdrive close to strong magnetic fields.
- Keep Microdrive dry.
- Do not apply strong pressure to the Microdrive cover.

### Notes on using media with a computer



- If you intend to take photos using a media that has been used on a personal computer, first format the media on your camera.
- When you format a media in the camera and then photograph and record images, a folder is automatically created on the media. Image data is then recorded in this folder.
- Do not change or delete the folder names or file names on the media from your computer as this will make it impossible to use the media in your camera.
- Always use the camera to erase image data on a media.
- To edit image data, copy the image data to the computer's hard disk and then edit the copied data.

### SmartMedia Specifications

Type	Image memory card for digital cameras (SmartMedia)
Operating voltage	3.3V
Conditions for use	Temperature: 0°C to +40°C (+32°F to +104°F) Humidity: 80% or less (no condensation)
Dimensions	37 mm × 45 mm × 0.76 mm (1.45 in. × 1.77 in. × 0.03 in.) (W × H × D)

# Warning Displays

►The table below lists the warning messages displayed on the top display panel or in the viewfinder.









Warning Displayed		Explanation	Remedy
Top display panel	View finder		
<b>FE E</b> (blinking)	<b>FE E</b> (blinking)	<ul style="list-style-type: none"> <li>• CPU Nikkor lens other than G-type is not set to its minimum aperture.</li> <li>• Attached flash is not set at TTL Auto Flash in "P" mode.</li> </ul>	<ul style="list-style-type: none"> <li>• Set lens to minimum aperture.</li> <li>• Set the external flash mode to TTL, or set the camera's exposure mode to "S", "A" or "M".</li> </ul>
 (lit)	—	• Lithium Batteries are low on charge.	• Have new ones ready.
 (blinking)	—	• Lithium Batteries have no remaining charge.	• Turn the power off and replace lithium batteries with new ones.
<b>F - -</b> (blinking)	<b>F - -</b> (blinking)	• Non-CPU lens is attached or lens is not attached.	• Attach CPU lens (except IX-Nikkor). With a non-CPU lens, set the exposure mode to "M" and set the aperture with lens' aperture ring.
—	● (blinking)	• Autofocus is not possible.	• Focus manually.
<b>HI</b> (lit)	<b>HI</b> (lit)	• Overexposure warning (subject is too bright).	<ul style="list-style-type: none"> <li>• In "P" mode, use ND filtre (If the warning indication remains after performing above remedies in "S" or "A" mode, use ND filtre as well).</li> <li>• In "S" mode, select faster shutter speed.</li> <li>• In "A" mode, select smaller aperture (larger f-number).</li> </ul>
<b>Lo</b> (lit)	<b>Lo</b> (lit)	• Underexposure warning (subject is too dark).	<ul style="list-style-type: none"> <li>• In "P" mode, use flash (If the warning indication remains after performing above remedies in "S" or "A" mode, use flash as well).</li> <li>• In "S" mode, select slower shutter speed.</li> <li>• In "A" mode, select larger aperture (smaller f-number).</li> </ul>
—	Electronic analog exposure display (blinking)	• Subject brightness is beyond camera's exposure range.	• When the subject is too bright, use ND filtre and when the subject is too dark, use flash too the electronic analog exposure display remains blinking when the flash is used.
<b>bulb</b> (blinking)	<b>bulb</b> (blinking)	• Shutter speed is set to "bulb" in "S" mode.	• Cancel the "bulb" or select "M" mode.
Shutter speed indication (blinking)	<b>125</b> (lit)	• Shutter speed faster than sync speed is selected in "S" or "M" mode.	• Release the shutter as it is to take a flash picture (Shutter speed automatically shifts to 1/125 sec.).
—	 (blinking)	• Flash has fired at full output and underexposure may have occurred.	• Shoot again after confirming focus distance, aperture or flash shooting distance range.
<b>Err</b> (blinking)	<b>Err</b> (blinking)	• Malfunction detected.	• Release shutter again. If the warning indication remains, or this warning appears frequently, contact you FUJIFILM dealer.

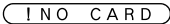

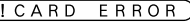
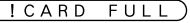

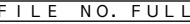
Warning Displayed		Explanation	Remedy
Top display panel	View finder		
<b>Err</b> (lit)	—	<ul style="list-style-type: none"> <li>• The slot cover was opened during card operation.</li> <li>• The AA-size batteries are low on charge or flat.</li> <li>• No AA-size batteries are loaded.</li> </ul>	<ul style="list-style-type: none"> <li>• Switch the camera off, close the slot cover, switch the camera back on and try again.</li> <li>• Switch the camera off and replace the AA-size batteries or load new AA-size batteries. Then switch the camera back on and try again.</li> </ul>
<b>Err</b> (blinking)	—	• The lithium batteries are low on charge or the camera mechanism has stopped due to cold and cannot take pictures.	<ul style="list-style-type: none"> <li>• Switch the camera off and replace the lithium batteries. Then switch the camera back on and try again. If this does not resolve the problem, set the focusing mode to "M", release the shutter and briefly switch the camera off.</li> </ul>

In certain cases, due to static electricity or poorly loaded batteries, the FinePix S2 Pro microcomputer may turn the camera off, even with fresh, properly installed batteries. For the same reason, the operation of camera may not advance properly during either "USB mode" or "IEEE1394 mode". In each of these cases, to resume operation, simply turn the power off, then turn it on again. Or, remove and reinstall the batteries.



## Warning Displays

►The table below lists the warning messages displayed on the top display panel or in the viewfinder.

Warning Displayed LCD monitor	Explanation	Remedy
	No media is inserted.	<ul style="list-style-type: none"> <li>• Load a SmartMedia (3.3V) in the correct direction.</li> <li>• Load a Microdrive in the correct direction.</li> </ul>
	<ul style="list-style-type: none"> <li>• The media is not formatted (initialized).</li> <li>• The SmartMedia contact area (gold-colored area) is soiled.</li> <li>• The camera is faulty.</li> </ul>	<ul style="list-style-type: none"> <li>• Format the media.</li> <li>• Wipe the SmartMedia contact area with a soft, dry cloth. It may also be necessary to format the SmartMedia. If an error message still appears, replace the SmartMedia.</li> <li>• Contact your FUJIFILM dealer.</li> </ul>
	<ul style="list-style-type: none"> <li>• The SmartMedia is not loaded correctly.</li> <li>• The SmartMedia contact area (gold-colored area) is soiled.</li> <li>• The media is damaged.</li> <li>• The media format is incorrect.</li> <li>• The camera is faulty.</li> </ul>	<ul style="list-style-type: none"> <li>• Push the SmartMedia all the way into the slot and check that it is locked into place.</li> <li>• Wipe the SmartMedia contact area with a soft, dry cloth. It may also be necessary to format the SmartMedia. If an error message still appears, replace the SmartMedia.</li> <li>• Contact your FUJIFILM dealer.</li> </ul>
	The media is full and no further data can be recorded.	Erase some images or use a media that has some available space.
	The SmartMedia is write-protected.	Use a SmartMedia that is not write-protected.
	<ul style="list-style-type: none"> <li>• You attempted to play back file that was not recorded correctly.</li> <li>• The SmartMedia contact area (gold-colored area) is soiled.</li> <li>• The camera is faulty.</li> </ul>	<ul style="list-style-type: none"> <li>• That data cannot be played back.</li> <li>• Wipe the SmartMedia contact area with a soft, dry cloth. It may also be necessary to format the SmartMedia. If an error message still appears, replace the SmartMedia.</li> <li>• Contact your FUJIFILM dealer.</li> </ul>
	Frame number 999-9999 has been reached.	Use a formatted SmartMedia to take pictures.
	<ul style="list-style-type: none"> <li>• Data cannot be recorded due to a media fault or a problem with the connection between the media and the camera.</li> <li>• The image you just shot is too large to fit in the space available on the media.</li> </ul>	<ul style="list-style-type: none"> <li>• Reload the media or switch the camera off and then on again. If this does not remedy the problem, contact your FUJIFILM dealer.</li> <li>• Use a new media.</li> </ul>
	You attempted to erase a protected frame.	Protected frames cannot be erased. Remove the protection using the camera on which the protection was applied.
 	You attempted to erase an image for which DPOF settings have been specified.	Erasing the image deletes the setting from the DPOF specifications at the same time.

Warning Displayed LCD monitor	Explanation	Remedy
	<ul style="list-style-type: none"> <li>• DPOF settings are already specified.</li> <li>• The DPOF file contains an error or was specified on another device.</li> </ul>	To create a new DPOF file and reset all the DPOF settings, press the "MENU/OK" button.
	1000 or more prints were specified in the DPOF frame settings.	The maximum number of frames for which printing can be specified on the same SmartMedia is 999. Set no more than 999 frames.
  	See P.92 for details.	

►The table below lists the warnings that are displayed on the rear display panel.

Warning Displayed Rear display panel	Explanation	Remedy
	The built-in flash was popped up even though the battery adapter is used.	The built-in flash cannot be used if the lithium batteries are not installed.
	The AA-size batteries are low on charge.	Have replacement AA-size batteries ready.
	The AA-size batteries are flat.	Replace the AA-size batteries.

# Troubleshooting

► If you think the camera is faulty, check the following once more

Troubleshooting	Possible causes	Solutions
The camera won't switch on.	<ul style="list-style-type: none"> <li>The batteries are exhausted.</li> <li>The batteries are loaded the wrong way round.</li> <li>The AC power adapter is not connected correctly.</li> </ul>	<ul style="list-style-type: none"> <li>Load new or fully charged batteries.</li> <li>Reload the batteries correctly</li> <li>Reconnect the adapter correctly and plug the adapter plug into the mains power outlet.</li> </ul>
Power cuts out during operation.	<ul style="list-style-type: none"> <li>The batteries are exhausted.</li> </ul>	<ul style="list-style-type: none"> <li>Load new or fully charged batteries.</li> </ul>
Batteries run out quickly.	<ul style="list-style-type: none"> <li>You are using the camera in extremely cold conditions.</li> <li>The battery terminals are soiled.</li> <li>The battery terminals were soiled when the batteries were charged.</li> <li>The batteries were charged after having not been used for a long period.</li> <li>The rechargeable batteries have reached the end of their operating lives.</li> </ul>	<ul style="list-style-type: none"> <li>Put the batteries in your pocket or another warm place to heat them and then load them into the camera just before you take a picture. Note that alkaline batteries cannot be used at very low temperatures.</li> <li>Remove the batteries from the camera and wipe the battery terminals with a clean, dry cloth before reloading the batteries.</li> <li>Wipe the battery terminals with a clean, dry cloth before charging.</li> <li>Due to their nature, the batteries may not be fully charged. Charge and use the batteries several times to restore them to normal operation.</li> <li>Load new fully charged batteries.</li> </ul>
No photograph is taken when the shutter button is pressed.	<ul style="list-style-type: none"> <li>The focus is not set in AF-S mode ("●" focus indicator not lit).</li> <li>No media is loaded.</li> <li>The media is full and no further data can be recorded.</li> <li>The SmartMedia is write-protected.</li> <li>The media is not formatted.</li> <li>The SmartMedia contact surface (the gold-colored area) is soiled.</li> <li>The media is damaged.</li> <li>The Auto Power Off function has switched the camera off.</li> <li>The batteries are flat.</li> <li>The camera will not focus.</li> <li>You are trying to take pictures using the built-in flash when there are no lithium batteries loaded in the camera.</li> <li>An error occurred.</li> </ul>	<ul style="list-style-type: none"> <li>Use AF lock to set the focus and check that the "●" focus indicator is lit before taking the shot.</li> <li>Load a media.</li> <li>Load a new media or erase some frames.</li> <li>Remove the write-protection.</li> <li>Format the media.</li> <li>Clean the SmartMedia contact surface (the gold-colored area) with a clean dry cloth.</li> <li>Load a new media.</li> <li>Switch the camera on.</li> <li>Fit new batteries.</li> <li>Set the focusing mode to manual (M), focus on the subject manually and take the picture.</li> <li>Close the built-in flash and then take the picture.</li> <li>Refer to the warning displays on P.114-117 and take the appropriate action.</li> </ul>
I can't use the flash to take pictures.	<ul style="list-style-type: none"> <li>The flash is set to Suppressed Flash mode. (The flash is closed.)</li> <li>You pressed the shutter button while the flash was charging.</li> <li>You are trying to take pictures using the built-in flash when there are no lithium batteries loaded in the camera.</li> </ul>	<ul style="list-style-type: none"> <li>The flash pops up.</li> <li>Wait until charging is completed before pressing the shutter button.</li> <li>Use lithium batteries.</li> </ul>
The playback image is too dark even though I used the flash.	<ul style="list-style-type: none"> <li>The subject is too far away.</li> <li>Something is obstructing the flash.</li> </ul>	<ul style="list-style-type: none"> <li>Move closer to the subject.</li> <li>Remove the lens hood.</li> </ul>

Troubleshooting	Possible causes	Solutions
The playback image is blurred.	<ul style="list-style-type: none"> <li>The lens is dirty.</li> <li>The camera is not focused.</li> </ul>	<ul style="list-style-type: none"> <li>Clean the lens.</li> <li>Focus the camera correctly (►P.30).</li> </ul>
I cannot format the SmartMedia or Microdrive.	<ul style="list-style-type: none"> <li>The SmartMedia or Microdrive is write-protected.</li> <li>The media is damaged.</li> </ul>	<ul style="list-style-type: none"> <li>Remove the write-protection (Peel off the write-protect sticker).</li> <li>Use a new media.</li> </ul>
I cannot erase all the frames.	<ul style="list-style-type: none"> <li>The frame is protected.</li> </ul>	<ul style="list-style-type: none"> <li>Remove the frame protection.</li> </ul>
Nothing happens when I use the camera switches and dials.	<ul style="list-style-type: none"> <li>Camera malfunction.</li> <li>The batteries are flat.</li> </ul>	<ul style="list-style-type: none"> <li>Remove the power supply (the batteries) and then reload them and try again.</li> <li>Fit new batteries.</li> </ul>
No image appears on the color LCD monitor when I press the "M" button.	<ul style="list-style-type: none"> <li>There is no media loaded.</li> <li>There is no photography data recorded on the media.</li> </ul>	<ul style="list-style-type: none"> <li>Insert a media that contains some photography data.</li> </ul>
There is no image on the TV screen.	<ul style="list-style-type: none"> <li>The camera and TV are not connected correctly.</li> <li>"TV" is selected as the TV input.</li> </ul>	<ul style="list-style-type: none"> <li>Connect the camera and TV correctly.</li> <li>Set the TV input to "VIDEO".</li> </ul>

# Specifications

## System

Type of camera	Interchangeable-lens SLR-type digital camera
No. of effective pixels	6.17 million
CCD sensor	Large-format (23.0 × 15.5 mm) Super CCD with primary color filters (total pixels: 6.49 million)
No. of recorded pixels	4256 × 2848, 3024 × 2016, 2304 × 1536 or 1440 × 960, with a maximum of 12.12 megapixels using signal processing
Sensitivity	Equivalent to ISO 100, 160, 200, 400, 800 or 1600 *1 Still images: DCF-compliant Compressed: Exif Ver.2.2 JPEG, DPOF-compatible Uncompressed: Exif Ver.2.2 TIFF-RGB, DPOF-compatible, CCD-RAW *2 Audio: Exif Ver.2.2 audio file standard-compliant
Recording modes	Slot 1: SmartMedia (3.3 V) Slot 2: Microdrive (CF+ type II) Some of Compact Flash may not work properly
Recording media	Slot 1: SmartMedia (3.3 V) Slot 2: Microdrive (CF+ type II) Some of Compact Flash may not work properly
LCD monitor	1.8-inch 110,000-pixels low-temperature polysilicon TFT color LCD panel (approx. 100% coverage for playback)
Lens mount	Nikon F mount (with AF coupling and AF contacts)
Interchangeable lenses	See P.18.
Focal length	Approx. 1.5× the nominal focal length of the lens (35mm camera equivalent)
Viewfinder	Eye-level type with pentaprism and built-in diopter adjustment (coverage: approx. 93% vertical and approx. 95% horizontal)
Focus	Auto focus, TTL phase detection with auxiliary AF lamp
Lens servo	"S" (single AF servo), "C" (continuous AF servo), "M" (manual)
Focus areas	1 focus area selected from 5 focus areas
AF area mode	Single-area AF, Dynamic AF (with a closest-subject priority dynamic AF function)
AF lock	AE/AF lock button. Can also be operated by pressing the shutter button halfway in single AF servo mode.
Metering modes	TTL open metering Selectable from 3 metering modes (restrictions apply on some lenses) • 3D 10-zone Matrix, Center-weighted, Spot
Exposure modes	<b>P</b> : Multi-programmed Auto (Flexible Program also available), <b>S</b> : Shutter-priority Auto, <b>A</b> : Aperture-priority Auto, <b>M</b> : Manual
Release modes	Single-frame, Continuous shooting (up to 7 frames), Self timer (2, 5, 10 or 20 sec.), Multi-exposure
Exposure compensation	±3 EV (in 1/2 EV step increments)
Auto bracketing	No. of shots: Up to 3; Exposure offset: ±2 EV in 1/2 EV step increments
AE lock	BV memory type using AF/AE lock button
Shutter	Electronically controlled descending-type focal-plane shutter
Shutter speeds	30 to 1/4000 sec, Bulb *3
White balance	AUTO, Sunny, Shade, Fluorescent 1, Fluorescent2, Fluorescent3, Incandescent and Custom (2 positions)
Image quality settings	Color, Tone (gradations), Sharpness
Built-in flash	Manual pop-up type. Guide No. 12 (ISO 100, m) Synchronizing shutter speeds: 1/125 sec. and slower Synchro modes: Front Synchro, Slow Synchro, Rear synchro, Red-eye Reduction and Red-eye Reduction Slow Synchro
Accessory shoe	Hot shoe (with synchro contacts, ready signal contacts, TTL flash control stop signal contacts, monitor signal contacts and GND) with built-in safety lock feature
Synchro contacts	X contacts only, synchronizing speed: 1/125 sec. or slower
Synchro terminal	Equipped with ISO519 synchro terminal as standard, lock screw provided
Remote release	Release socket on shutter button
Information display	Viewfinder display, Top display panel, Rear display panel
Battery checks	• Battery checking performed for lithium and AA batteries. However, only the AA batteries are checked when no lithium batteries are installed. • Check levels: 3 levels (full, flat and low). If either the lithium or AA batteries have insufficient charge, a warning is displayed for 3 seconds and then the Auto Power Off function is triggered.
Auto Power Off	Off, 15 sec., 2 min. or 5 min. (disabled when the camera is connected to a PC)
Preview	Preview zoom, histogram display, standard chart display
Playback	Single-frame, playback zoom, histogram display, protect frame, multi-frame playback

Erase	Erase frame, Erase all frames, Format (initialize)
Other	Print ordering (DPOF), Voice memo, Frame No. memory, Custom settings

## Standard Number of Available Shots per Media

The number of available shots varies slightly depending on the type of subject. Also, the discrepancy between the actual number of available shots and the standard number grows as the capacity of the media increases.

Number of recorded pixels	4256 × 2848			3024 × 2016			2304 × 1536			1440 × 960			
	HIGH TIFF-RGB	CCD-RAW	FINE	NORMAL	HIGH TIFF-RGB	FINE	NORMAL	HIGH TIFF-RGB	FINE	NORMAL	HIGH TIFF-RGB	FINE	NORMAL
Image File Size	Approx. 35.5MB	12.4MB	4.7MB	2.2MB	Approx. 17.9MB	Approx. 2.3MB	1.1MB	Approx. 10.4MB	1.3MB	660KB	Approx. 4.1MB	690KB	350KB
MG-16S (16MB)	0	1	3	6	0	6	13	1	10	23	3	22	44
MG-32S (32MB)	0	2	6	13	1	12	27	3	22	47	7	45	89
MG-64S (64MB)	1	4	13	28	3	26	55	6	45	94	15	92	180
MG-128S (128MB)	3	9	26	56	7	52	112	12	90	189	30	185	362
Microdrive 340MB	9	26	73	156	19	145	307	33	249	525	84	507	992
Microdrive 1GB	29	80	220	468	58	437	912	100	746	1564	254	1492	2986

For CCD-RAW files, "RAW" is displayed as the resolution.

## Input/Output Sockets

VIDEO OUT	For connecting a mini pin jack (3.5 mm dia.) cable for video output to a TV
IEEE1394 socket	For connecting a 4-pin IEEE1394 cable for data exchange with a computer and picture taking from a computer
USB socket	For connecting the special USB cable for data exchange with a computer
DC input socket	For connecting the special AC Power Adapter AC-5VH/AC-5VHS to supply power to the camera

## Power Source, etc.

Power source	CR123A lithium batteries (2) AA-size batteries (4) (alkaline or nickel-metal hydride) Special AC Power Adapter AC-5VH/AC-5VHS
Operating conditions	Temperature: 0°C to +40°C. (+32°F to +104°F) (Note that the range for Microdrive is +5°C to +40°C (+41°F to +104°F).) Humidity: 80% or less (no condensation)
Dimensions (W × H × D)	141.5 × 131 × 79.5 mm (5.6 × 5.2 × 3.1 in.) (excluding lens and attachments)
Mass (Weight)	760 g (26.8 oz.) (body only, not including accessories, batteries or recording media)

## Available shots using batteries (When fully charged) \*4

Battery type	Alkaline batteries	Ni-MH batteries HR-3UF 1700 mAh	CR123A lithium batteries
SmartMedia	Approx. 600 frames	Approx. 650 frames	Approx. 1000 frames
Microdrive	Approx. 420 frames	Approx. 450 frames	

Accessories	See P.5
Optional accessories	See P.105-106

- \*1: Images shot in high-sensitivity photography (ISO 400 or higher) may appear coarse and may also be affected by noise such as white dots.  
\*2: CCD-RAW is a format specific to the FinePix S2 Pro. The enclosed "FinePix Viewer" software or the optional Hyper-Utility software "Shooting Software" is required to interpret the images.  
\*3: Images shot with long exposures (1 second or longer) may appear coarse and may also be affected by noise such as white dots.  
\*4: The figures shown for the number of available shots are a guide to the number of consecutive shots that can be taken at normal temperatures with the flash used in 50% of the shots. Note that the actual number of available shots may differ due to variations in the ambient temperature when the camera is used and the amount of battery charge. The number of available shots is lower at low temperatures.

\* These specifications and performance data are subject to change without notice. FUJIFILM accepts no liability whatsoever for errors or omissions in this manual.  
\* The color LCD monitor on your digital camera is manufactured using advanced high-precision technology. Even so, up to 0.01% of the pixels may fail to light or may remain permanently lit. This phenomenon will not appear on the recorded image.  
\* The operation error may be caused in a digital camera by the strong radio interference (i. e. electric fields, static electricity, line noise, etc.).

## Explanation of Terms

### Auto Power Off Function:

If the camera is not used in any way for a set period, the Auto Power Off function switches the camera off to prevent battery depletion and to avoid wasting power when the camera is connected to the AC power adapter. Preview image display is also cancelled when this function operates.

- The Auto Power Off function does not operate, when a USB connection is being used, or when the Auto Power Off function is switched off during setup.

### CCD-RAW

This is the image data prior to signal processing (the reconstruction of the data read in from the CCD as an image). Because the signal processing is performed on the computer, high levels of control are possible.

- \* To reconstruct images, FinePixViewer (on the enclosed CD-ROM) or the Hyper Utility (optional) must be installed on your computer.

### Color Temperature:

Low-temperature light sources, such as a candle flame, are strongly red, while high-temperature light sources, such as a gas burner flame, are strongly blue. The color of the light for these temperatures is expressed as a color temperature (K = Kelvin). The light of the sun at midday in a completely clear sky is taken to be 5500K.

### EV:

A number that denotes Exposure Value. The EV is determined by the brightness of the subject and sensitivity (speed) of the film or CCD. The number is larger for bright subjects and smaller for dark subjects. As the brightness of the subject changes, a digital camera maintains the amount of light hitting the CCD at a constant level by adjusting the aperture and shutter speed. When the amount of light striking the CCD doubles, the EV increases by 1. Likewise, when the light is halved, the EV decreases by 1.

### JPEG:

Joint Photographics Experts Group

A file format used for compressing and saving color images. The compression ratio can be selected, but the higher the compression ratio, the poorer the quality of the expanded image.

### TIFF-RGB:

A format for saving image data in which a tag indicating the file format is attached to each item of data. Files stored in this format can be opened on a personal computer.

### WAVE:

A standard format used on Windows systems for saving audio data. WAVE files have the ".WAV" file extension and the data can be saved in either compressed or uncompressed format. This camera use PCM recording.

WAVE files can be played back on a personal computer using the following software:

Windows: MediaPlayer

Macintosh: QuickTime Player

\* QuickTime 3.0 or later

### White Balance:

Whatever the kind of the light, the human eye adapts to it so that a white object still looks white. On the other hand, devices such as digital cameras see a white subject as white by first adjusting the color balance to suit the color of the ambient light around the subject. This adjustment is called matching the white balance. A function that automatically matches the white balance is called an **Automatic White Balance function**.



Exif Print Format is a newly revised digital camera file format that contains a variety of shooting information for optimal printing.

## Safety Notes

- To ensure that you use your FinePix S2 Pro camera correctly, read these Safety Notes and your Owner's Manual carefully beforehand.
- After reading these Safety Notes, store them in a safe place.

### About the Icons

The icons shown below are used in this document to indicate the severity of the injury or damage that can result if the information indicated by the icon is ignored and the product is used incorrectly as a result.

 **WARNING** This icon indicates that death or serious injury can result if the information is ignored.

 **CAUTION** This icon indicates that personal injury or material damage can result if the information is ignored.

The icons shown below are used to indicate the nature of the information which is to be observed.

 Triangular icons notify the user of information requiring attention ("Important").

 Circular icons with a diagonal bar notify the user that the action indicated is prohibited ("Prohibited").

 Filled circles with an exclamation mark notify the user of an action that must be performed ("Required").

### WARNING

**When a fault arises, switch the camera off and then remove the batteries and disconnect the AC power adapter.**

Continued use of the camera when it is emitting smoke, is emitting any unusual odor, or is in any other abnormal state can cause a fire or electric shock.

- Contact your FUJIFILM dealer.



Unplug from power socket.

**Do not allow water or foreign objects to enter the camera.**

If water or foreign objects get inside the camera, switch the camera off, remove the battery and disconnect and unplug the AC power adapter. Continued use of the camera can cause a fire or electric shock.

- Contact your FUJIFILM dealer.



**Do not place the camera on an unstable surface.**

This can cause the camera to fall or tip over and cause injury.



**Do not use the camera in the bathroom or shower.**

This can cause a fire or electric shock.



Do not use in the bathroom or shower.

**Never attempt to modify or disassemble the camera. (Never open the casing.)**

Do not use the camera when it has been dropped or the casing is damaged. This can cause a fire or electric shock.

- Contact your FUJIFILM dealer.



Do not disassemble.

**Never attempt to take pictures while in motion.**

Do not use the camera while you are walking or operating a moving car or other vehicle.



This can result in you falling down or being involved in a traffic accident.

**Do not heat, modify or attempt to disassemble the batteries. Do not drop or subject the batteries to impacts.**

**Do not attempt to recharge lithium or alkaline batteries. Do not store the batteries with metallic products.**

















Any of these actions can cause the batteries to burst or leak and cause fire or injury as a result.

**Do not touch any metal parts of the camera during a thunderstorm.**

This can cause an electric shock due to induced current from the lightning discharge.



 <b>WARNING</b>	
<p><b>Do not use the batteries except as specified.</b> Load the batteries with correct polarity as indicated by the ⊕ and ⊖ marks.</p>	
<p><b>Use only the batteries or AC power adapter specified for use with this camera.</b> The use of other power sources can cause a fire.</p>	
<p><b>If the battery leaks and fluid gets into your eyes or comes into contact with your skin or clothing, this can cause injury or loss of eyesight. Immediately flush the affected area thoroughly with clean water and seek medical treatment.</b></p>	
<p><b>When discarding or storing batteries, cover the battery terminals with insulation tape.</b></p> <ul style="list-style-type: none"> <li>● Contact with other metallic objects or batteries could cause the batteries to ignite or burst.</li> </ul>	

 <b>CAUTION</b>	
<p><b>Keep out of the reach of small children.</b> This product could cause injury in the hands of a child.</p>	
<p><b>Do not use this camera in locations severely affected by oil fumes, steam, humidity or dust.</b> This can cause a fire or electric shock.</p>	
<p><b>Do not leave this camera in places subject to extremely high temperatures.</b> Do not leave the camera in locations such as a sealed vehicle or in direct sunlight. This can cause a fire.</p>	
<p><b>Do not place heavy objects on the camera.</b> This can cause the heavy object to tip over or fall and cause injury.</p>	
<p><b>Do not move the camera while the AC power adapter is still connected.</b> This can damage the power cord or cables and cause a fire or electric shock.</p>	
<p><b>Do not cover or wrap the camera or the AC power adapter in a cloth or quilt.</b> This can cause heat to build up and distort the casing or cause a fire.</p>	
<p><b>Remove the batteries and disconnect the AC power adapter when you are cleaning the camera or if you intend to leave the camera unused for a long period.</b> Failure to do so can cause a fire or electric shock.</p>	
<p><b>Using a flash too close to a person's eyes may temporarily affect the eyesight.</b> Take particular care when photographing infants and young children.</p>	
<p><b>Request regular internal testing and cleaning for your camera.</b> Build-up of dust in your camera can cause a fire or electric shock.</p> <ul style="list-style-type: none"> <li>● Contact your FUJIFILM dealer to request internal cleaning every 2 years.</li> </ul>	







---

**FUJI PHOTO FILM CO., LTD.**  
26-30, Nishiazabu 2-chome, Minato-ku, Tokyo 106-8620, Japan

Printed in Japan

Printed on recycled paper.

FGS-204104-FG