



The Canon AE-1 was the first 35mm SLR camera to be controlled solely via a built-in Central Processing Unit (CPU) and made SLR photography available to beginners and amateurs at a reasonable prices - with a record of over 5 million units been sold worldwide, the success of which firmly established Canon as the leader in camera innovations.

It revolutionized many of the concepts for future camera designs especially in the field of electronic applications and mass produced technique with a lower cost of production with the use of plastic injection molding, resulting in simpler assembly of parts. It also popularized and made devices like Power Winder and electronic Speedlites a household name in the consumer market. The camera was controlled entirely by electronics precision rather than by mechanical functions - and depends solely on battery power for all of its functions. Despite defying the mainstream camera design concept in the '70s, the AE-1 came through well and attained a huge during its availability years. This was very much due to Canon's efforts in promoting the camera - it offers very precise and stable timing of shutter speeds, which was also extended to other areas like auto flash-synchronization speed when any dedicated Canon electronic Speedlites is used. Although the technologies employed within the AE-1 looked very simple when compared with today's modern SLR cameras, it has to be remembered that during its era, the market was still dominated largely by those heavy, mechanically-controlled type of cameras. Canon used these points to enhance the advantages of electronic applications in camera designs - where in many areas, electronic cameras do offer much more precise timings and other features that can never be matched by mechanical technologies.

However, the AE-1 was not in anyway a professional-grade SLR as compared to the Canon F-1. It was generally regarded as a classic and top amateur SLR model due to the impact it has created with its then innovative concept that went on to influence other future camera designs, both Canon and other makes, of the industry as a whole. The camera was eventually replaced by a newer model with added features, the AE-1 Program in 1981, following on the success of Canon's semi-pro and top-of-the-line A-series camera, the multi-mode Canon A-1, which made its debut in 1978.



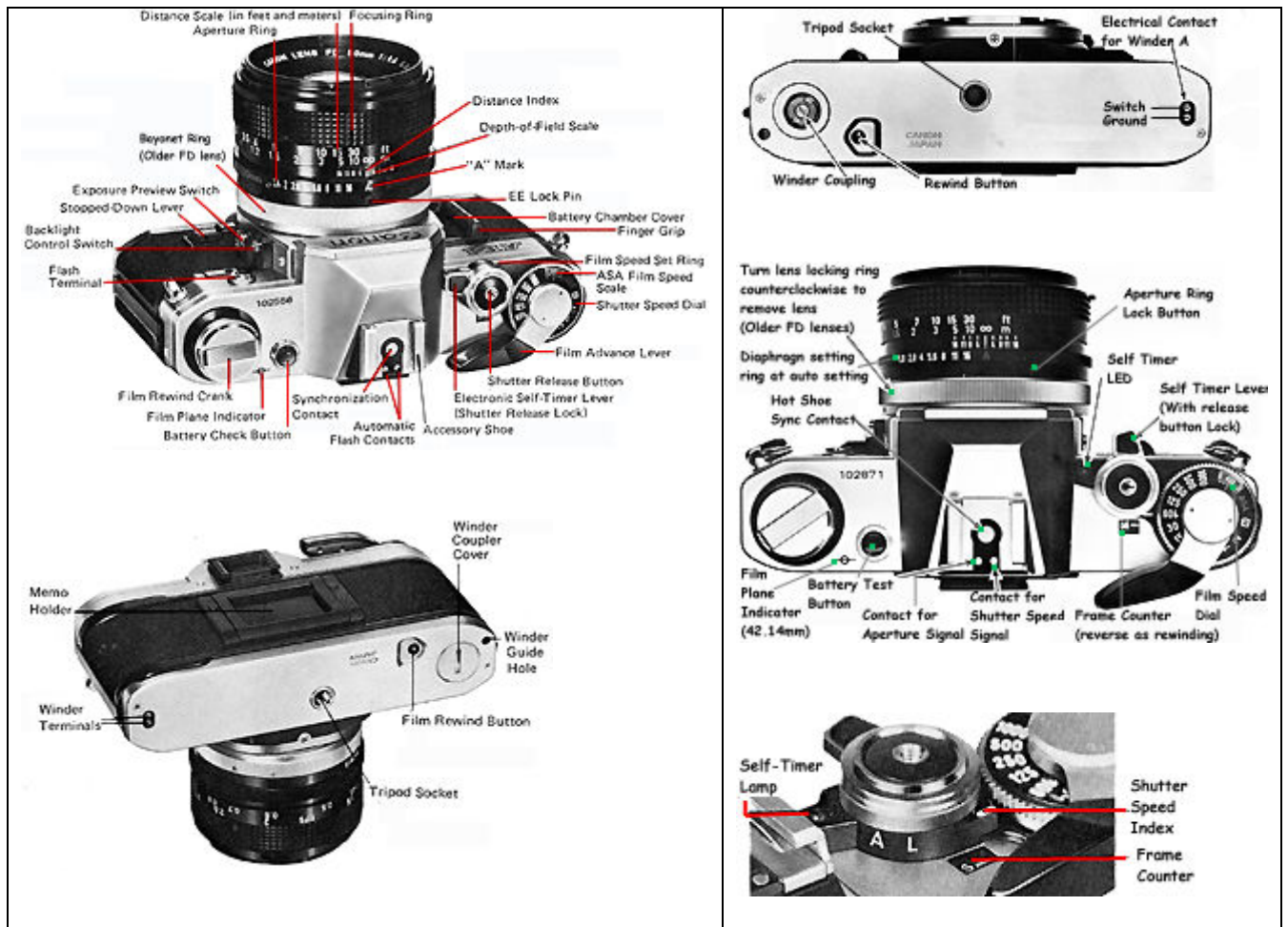

- Characteristics**
1. Total Automatic System with a built-in CPU (Central Processing Unit), the first 35mm SLR camera in the world to do so.
 2. Shutter Speed Priority AE Camera Good for Fast Breaking Action. With Less Chance of Camera Shake.
 3. Compact and Lightweight Design Facilitating Mobility and Handling Ease.
 4. Continuous Shooting with Power Winder A.
 5. AE (Automatic Exposure) Computer Flash Unit, Speedlite 155A - world's first Dedicated autoflash.
 6. Full Use of Canon FD Lenses.

CANON AE-1's MAIN FEATURES

1. Very Little Battery Consumption.

The battery lasts the equivalent of 20,000 shutter releases or one year under **normal use**.

Usable Batteries

Silver Oxide Battery (6V)

Eveready (UCAR) No. 544 JIS 4G13, Mallory PX28

Alkaline Manganese
Battery (6V)

Eveready (UCAR No.537, Mallory 7K13

2. Convenient Finger Grip Bar.

3. Battery Check Button.

OK if the meter needle rests below the index. Without sufficient battery power, a safety mechanism will prevent the shutter release. This button also serves to cancel the self-timer

operation.

4. Electromagnetic Shutter Release Button

Activated by a Very Smooth Touch. Two-step shutter button. Light metering is activated by the halfway depression and shutter release by the further depression.

5. Immediate Response Metering. Light metering takes only 0.001 sec. at EV 12.

6. Shutter Speed Priority AE Camera.

High mobility. Less chance of camera shake. Effective for fast breaking action.

7. Compact and Lightweight Design.

590g (20-13/16 ozs.) body only. 790g (27-7/8 ozs.) with the 50mm f/1.8 S.C. lens. 895g (31-9/16 ozs.) with the 50mm f/1.4 S.S.C. lens.

8. Design Based on Human Engineering Technique.

Rounded back contours and large operational parts that fit to hand. Finger grip bar. Film advance with 120° throw. One finger operation.

9. Other Features.

Interchangeable back cover.

Memo holder.

Backlight control switch.

Electronic self-timer.



But up to the mid-'70s, electronics control and applications in SLR cameras were still limited, for example, where the mechanical designs were largely responsible for much of the operations. But the AE-1 was the first camera in the world to incorporate a CPU (Central Processing Unit) which enabled automatic exposure, memory transmission of signals, display, regulation of time and completion signal are all electronically controlled.

All these were packed in a economical price range - it is an entirely new kind of SLR camera during that time. Canon AE-1 was massed produced with new manufacturing and assembling techniques even though it had made its debut during an economic slump. The high degree of automation was not been restricted only to the camera. It was extended to the various accessories, all with the same standard of precision. The AE-1 was also the first camera to offer a totally automated electronic photographic system. It takes its name, AE-1 (Automatic Exposure-One), from this concept.

Application of Electronics is the Cornerstone of the Entire Design Automation in the AE-1 was made possible by the application of the 'most advanced' available electronic technologies during the seventies (Although it may sound pretty much outdated when compared with today's electronics standard), and after a thorough analysis of all the mechanisms and their operations. The important mechanical features made way for the electronic ones, thus changing the very essence of the camera's design.

As a result, a miniature computer (CPU) was successfully incorporated in the AE-1 for the first time in the world to compute, judge, control, display and regulate required information - in certain ways, unmatched by mechanical mechanism especially where the precise timing of the shutter speeds and electronic flash compatibility.

The (Integrated Injection Logic), as far as its application in photography is concerned, was the most outstanding achievement in the field of electronics during the early and mid-'70s. An

LSI digital circuit with extremely high properties of accumulation, an operational amplifier, a circuit with full use of an analog switch, a hyperbolic function resistance using both thick and thin film technology, an analog digital converter, and the proper interfaces, together with their constructions and arrangements in modular form, represent the technological breakthroughs in camera design and made mass production possible, which in turn, made photography more affordable to the general consumers.

Exceptional Reliability through Application of Electronics The Canon AE-1, since it employed computer technology and its overall design was based on electronics, opened the doors to a new age in the camera world. In order to make an inter-related package out of all the inner mechanisms and to automate the assembly process, each and every part must be built with a very high degree of precision.



And Canon extensively used computers to automate the design of the modules as well as the assembly, manufacturing and finishing processes. In a way, the AE-1 has influenced (and inspired) many other manufacturers to look into the application of plastic materials in camera manufacturing to reduce costs of production. Although the Canon AE-1 has shiny metallic finishing and even sounds like a metal when you used your finger to knock on its shell, in reality, it was a clever use of a production technique with an underlying coating of Iron Oxide beneath the plastic which gave it such a similar metallic feel. But the key essential parts like the lens mount, had used metal as the prime material. But undeniably, the modular construction of the camera allowed acceleration in its production with the more uniformed quality control..

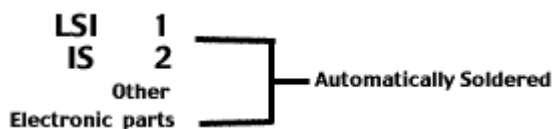

Flexible Substrate of the Canon AE-1 **PL(integrated Injection Logic)** High grade of LSI technique used. Equivalent to three chips of IC consisting of more than 1,000 elements.

By using new production methods and the adoption of highly advanced packaging techniques in the manufacture of electronics circuitry, the vital parts were completely sealed to keep out dust and humidity and reduce the effects of temperature. The IC and resistance circuits were built as units. Not only was the wiring streamlined to increase efficiency, but also the new modular joints and all other main parts were completely sealed to obtain the best possible weather proofing (but **it was not** a water proof camera).

Interface Interface as a common boundary of mechanics and electronics. Three magnets: 1) For camera function start, 2) For AE aperture control, 3) For second shutter curtain control were used to enhance reliability and precision which provides a matching precision assured by

ball bearings. While combination of permanent magnet and electromagnet which use very little battery consumption and the omission of holding mechanisms.

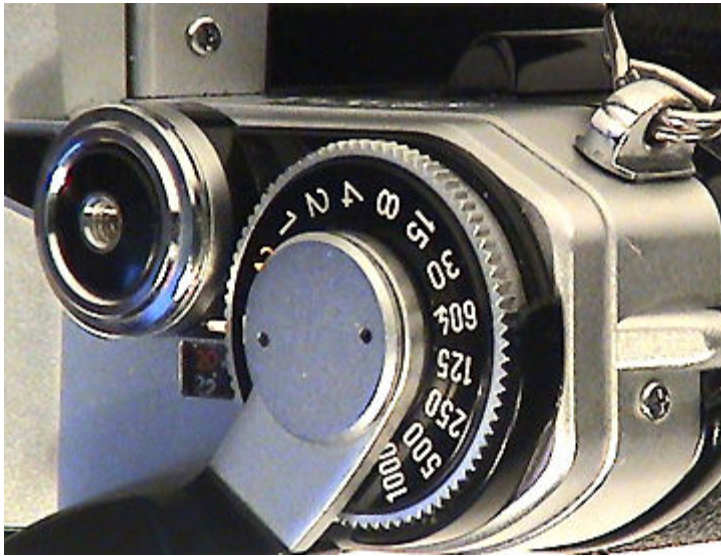

Shutter Priority Automatic exposure (AE) System Canon's earlier screw mount models, the EX EE (1969) and EX AUTO (1972) have already offered Shutter-priority AE in their exposure control system while the FD lenses, which also used the famed breech-lock mount (but with auto-diaphragm) as found in the FL-type lenses, were introduced along with the **Canon F-1** in 1971. It was still too early to see an SLR model exploring the potential benefits of what the 'new' and sophisticated breech lock mount system these FD lenses can offer.

The AE-1, which has a Shutter-priority AE system that can automatically decides the correct diaphragm opening of the lens you are using according to the light the subject is reflecting, based on the shutter speed that has been previously set. This is the meaning of shutter speed priority. The pins and structures of all FD lenses allows the AE-1 to couple with the functions of the Shutter speed priority AE.

Therefore, as you compose the picture, you can freely choose the shutter speed that corresponded to the speed at which the subject is moving.

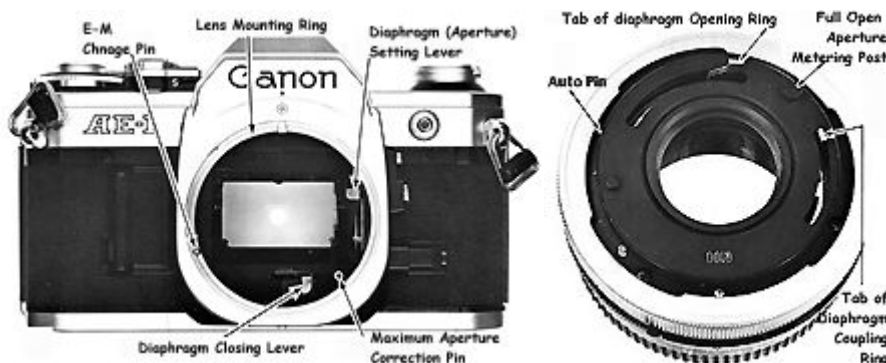

A Gentle Touch Activates the Shutter Button This unique shutter button activates a complex of electronically controlled functions, a technological feat since such a design has never been realized previously by the other manufacturers. As opposed to the conventional mechanical systems, it serves as a switch to turn the electronic circuitry on or off, and

operates magnetically, in order to make the shutter release extremely fast and smooth.

The design of the shutter release button also uses the sequential electric supply ON and OFF. Power is sequentially switched on-off only when the shutter button is depressed and this minimized power consumption. Furthermore, it decreased harmful electric noises.

Immediate Response Metering From light metering to exposure setting, all the functions are electronically controlled. With this astounding, revolutionary system, the very instant the shutter button is pressed, the electronic brain (CPU) immediately computes the photographic information and produces the- operating command. Light metering takes place at a speed impossible to attain with other cameras. In EV 1 lighting conditions, light metering takes but only 0.04 sec. With other features like exposure compensation button for an even more precise control of AE photography, there were plenty of ways that can be used to handle automatic exposures without the need to worry about inaccuracies in metering and exposure timing. The shutter button activates light metering and shutter release in succession and practically simultaneously.

Instantaneous response. **0.001 sec. at EV 12 (1/125 sec., f/5.6)**
 0.04 sec. at EV 1 (1 sec., f/1.4)

An Electronic Brain for Instantaneous Control For the first time in the world, this camera adopts a system based on **PL**(Integrated Injection Logic) technology, the most advanced electronic development applicable to photography during that time. The electronic brain (CPU) controls all functions something no other similar class of camera offered during that period.

Silicon Photocell and Logarithmic Amplifier In A Single IC The SPC (silicon photocell) is well known for its outstanding photo-sensitive characteristics which yields greater responsiveness with greater linearity (straight line characteristic) and a wider metering range.

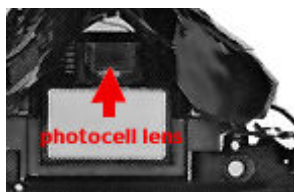

The SPC cell, housed near the eyepiece, has a logarithmic amplifier and a special, immediate response circuit, integrated into a single IC in order to obtain the speediest responsiveness while at the same time ensuring remarkable overall durability.

Power-Saving Circuit The main parts were designed so as to require the minimum of energy while a sequential command controls energy cut-off and supply. Thus, there is no unnecessary battery consumption. A battery lasts the equivalent of 20,000 shutter releases (almost 556 rolls of 36-exposure film) in continuous photography, or one year under normal use.

Compact, Light weight Design for Great Handling Ease Although still consider bulkier when compared with compact SLR cameras such as the Olympus OM-1, but within the Canon line, the body dimensions have been reduced as compared with other models such as Canon F-1, and the lightweight structure, with a special finger grip and rounded back contours, provides great handling ease.

Automatic Film Winding with the Canon Power winder A



There is no doubt that AE-1 has helped Canon shoot to the top as a major 35mm SLR camera manufacturer, with some original ideas such as automatic film advance devices using a power winder, a convenient and economical accessory in photography. The Power Winder A, extremely easy to attach, enables the AE-1 to photograph continuously at up to 2 frames per second. This feature is enhanced by the fact that actual handling of the AE-1 is very much the same with or without this accessory attached.

Canon Speedlite 155A, the World's First AE Computer Flash Benefiting with the CAT system used in the professional F-1 model, a new automatic flash system was refined from the earlier technology used, in which a dedicated flash unit, like the Speedlite 155A is used with the AE-1, flash photography can be performed with the aperture ring set at the "A" mark for automatic exposure. When the pilot lamp lights to indicate the proper charging level has been reached, the shutter speed is automatically set (1/60 sec) and the aperture automatically determined. After the flash, the camera returns to its original AE setting.

Data Imprinting Mechanism The film back of the AE-1 is a removable part. **The Data Back A**, an optional accessory when attached in place of the AE-1's normal back cover, can directly imprint the date and other information on the negative or slide film at the very moment the picture is taken. This information is imprinted in the lower right hand corner of the picture and is most convenient for keeping track of the dates of your photographs or classifying them in general. However, there was a little mistake made when the design was adopted, nothing relative to mechanical or electronic flaws - but an oversight which Canon didn't expect that the databack will be so 'lasting' - the input numerals for the 'year' on the first control wheel was provided until the year of 1987 only.

However, if compared with the Databack produced by competing manufacturers like Nikon's MF-12 for the FE, where the LCD version has digits that lasts until the year 2019, the Canon has some advantages by way of its Roman numerals from I to X, some used it to solve the problem, of which current years could be indicated by the Roman numeral for the second digit. The second wheel can be used for months, but also has numbers from 1 up to 31 as well as letters from A to G. The third wheel has numbers from 0 to 31. As with the other earlier databacks, you need to plug a short cable which came from the left-hand side of the Data Back A into the PC terminal socket on the AE-1 camera for proper operation. Well, if you wish to use the Data Back A and a non-hot shoe flash at the same time, you must plug the PC cord from the flash into the PC socket on the Data Back A.



The advantage of having an interchangeable lens ability is the large collection of used FD Lenses The theoretically long lasting and “wearless” breech-locked mount FD lenses are one of the key outcome of the application in first rated electronics technology in the field of optics. Their image sharpness and color reproduction abilities are of extremely high standard. Canon offered a full array of interchangeable lenses ranging from the 7.5mm fisheye to the 1200mm super telephoto, totaling as many as 55 lenses including the special purpose lenses up to the time when the whole line-up was slated for discontinuation. That was another reason why the AE-1 was so successful commercially, as the general public was able to experience the thrill and excitement of lens interchangeability in SLR photography. But as a new user to SLR photography, if you have little intention to upgrade, the 'abandoned' FD lens-based SLR camera like the AE-1, with the huge pool of resources available in the used market presents a really attractive alternative if your budget is tight. But if you intend to grow with the system and migrated to autofocus or action related photography in the future, I do have a little reservation to invest into the manual focus FD system. But as I said, photography is not all about autofocus and the medium is not as economical and regarded as an cheap 'hobby' as compared with the early days of manual focus photography, the AE-1 still possesses some charm that can be considered as a good and logical entry.

If you have owned or purchase a AE-1, these are few essential but relatively easy steps for you to setup your camera to take pictures (Section one for the camera, section two when you are using it with flash and lastly, with a auto film advance device like the dedicated Auto Winder). If you intend to understand more about the details, please read through the whole site for other related content to fully explore the potential this camera can offer you.

Basic Setup Steps for Camera Operations



1. Set the aperture ring of the lens to the "A" mark.



2. Load the battery.

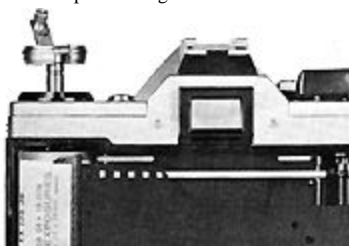

3. Load the film.



4. Set the ASA film speed.



Select a shutter speed.

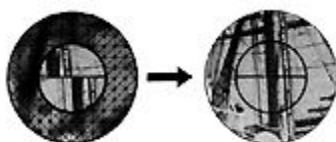

Out of Focus

In Focus

5. Look into the viewfinder Compose the picture and focus.



6. Advance film; Check exposure. Press the shutter button.

Photography with earlier flash unit 155A automatic Flash photography (Or any dedicated flash units by Canon)



1. Load the batteries.



2. Set the ASA film speed

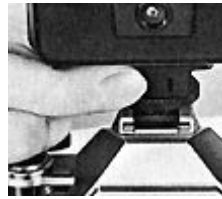

3. Mount the Speedlite 155A (Or equivalent) onto the camera



4. Turn the main switch5. Set the AUTO/MANUAL switch

6. Focus, compose and press the shutter button to take the picture.

Photography with the Canon Power Winder A

1. Remove the Battery Pack A.
2. Load the batteries into the Battery Pack A.
3. Attach the Battery Pack A to the Power Winder A.
4. Take off the winder coupler cover.
5. Attach the Power Winder A to the AE-1.
6. Turn the main switch on.
7. Focus and press the shutter button.



Preliminary Preparation for AE-1



Attaching the Neckstrap

Attach the Canon AE-1's neckstrap by threading it through the rings and adjusting it to the desired length as indicated in the photos. A case for a spare battery can be attached to the neckstrap.

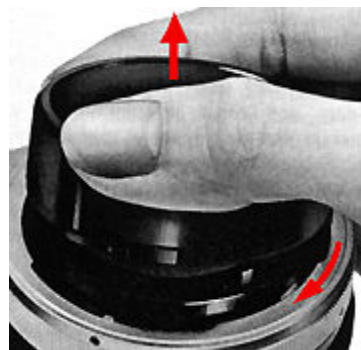

Handling the Lens Cap

The lens cap can be removed from the front of the lens after pressing in the tabs on both sides of the cap. The rear dust cover can be removed by turning the bayonet ring in the direction of the arrow.

To attach the dust cover, align its slot with the positioning pin below the red dot of the bayonet ring, and press it in. When the dust cover is removed the bayonet ring is locked.



1. Mounting the Lens onto the camera

Remove the body cap and mount the lens onto the camera. The lens is mounted by aligning the red dot of the body with the red dot of the bayonet ring, and then turning the bayonet ring clockwise, pressing gently until it locks into position. Reverse the procedure to dismount the lens.



2. Setting the Aperture Ring to the "A" Mark

The AE-1 delivers perfect AE photography when the aperture ring is set for automatic exposure. The "A" mark on the aperture ring should be set to the EE position. Hold in the EE lock pin while turning the aperture ring to the "A" mark. This can be done either before or after the lens is mounted on the camera.

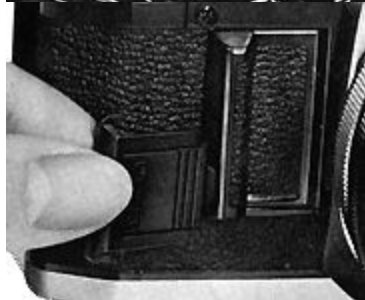

3. Loading the Battery

This camera will not function without battery power. A 6V silver oxide or alkaline battery is loaded into the battery chamber after opening the battery chamber cover. It can be opened more easily by using the viewfinder cover that is inserted into the accessory shoe.

Be careful to load the battery correctly with the "+" side up as indicated in the diagram. Load the battery by inserting first the "-" contact in the battery chamber. The battery can be unloaded in a similar way by pulling it out from the top. The battery can be loaded and unloaded more easily when the lens is dismounted.

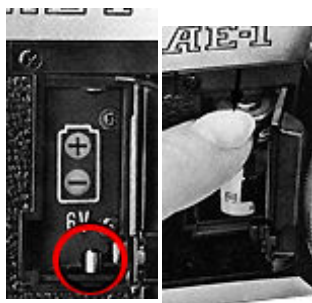

The battery should last for approximately one year under normal use. Check on other section with specifications of the battery when the camera is used in extremely cold conditions.

4: Checking the Battery

Since the AE-1 is an electronically controlled camera, the shutter will not function without sufficient battery power. The battery requires checking in the following circumstances:

1. When a new battery is loaded.
2. When the shutter does not function.
3. When long exposures are frequently performed.
4. When the camera is used very frequently.



5. When the camera is used after it has been stored for a long period.
- When the camera is used in extremely cold conditions.



Usable Batteries: Silver Oxide Battery (6V) (Eveready (UCAR) No.544, JIS 4G 13, Mallory PX 28; Alkaline Manganese Battery (6V) (Eveready (UCAR) No.537, Mallory 7K 13)

How to Check the Battery The charge level of the battery is checked by pressing the battery check button on the top of the camera Carefully watch the meter needle in the viewfinder.

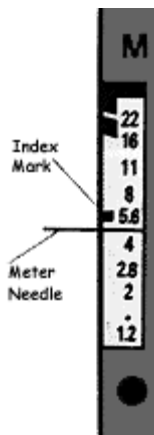

Press the battery check button and if the meter needle in the viewfinder rests below the index, power level is sufficient. If the meter needle rests above the index, the power level is insufficient. If this is the case, replace the battery with a new one of the prescribed type. When a new battery with full voltage is used, the meter needle in the viewfinder indicates close to the 2.8 f/stop. When the battery power wanes, it takes more time for the meter needle to stop fluttering.

Because of the special circuit, the meter needle's swing depends on the state of the battery. The meter needle will rise as the battery power wanes until it reaches the f/5.6 position where there is no longer any more power. Press the battery check button until the meter needle rests still. When the battery is just about to fail, the meter needle in the viewfinder rests close to the index.

5. Loading the Film The Canon AE-1 uses color or black and white film in standard 35mm cartridges. Since this is a 25 years old camera, you can't expect it is as convenient as today's modern SLR with nifty feature such as **Auto DX coding** , auto film advance and power rewind. Most of this procedures have to handle them manually.

Opening the Back Cover To load a cartridge of film into the camera, first open the camera's back cover. Pull up the rewind crank and the back cover will pop open. The back cover can be securely closed simply by pressing it until it locks.

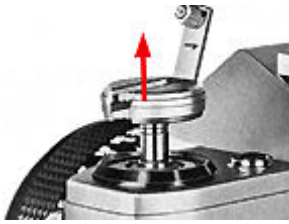

An optional accessory, Canon Data Back A, a recording device for imprinting data such as the day, month and year, can be attached to the AE-1 in place of the standard back cover.

How to Load the Film Note: ALWAYS avoid direct sunlight when loading or unloading the film. Put the cartridge into the film cartridge chamber and press down while rotating the rewind knob until it drops securely into position. The protruding part of the cartridge should be on the bottom. Pull the film leader across and insert the end into one slot of the multi-slot take-up spool.

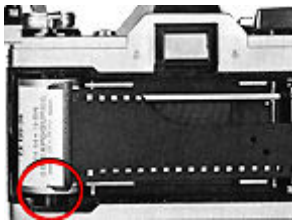

Turn the film advance lever and wind the film around the take-up spool making sure that the perforations of the film are engaged in the teeth of the film transport sprocket.

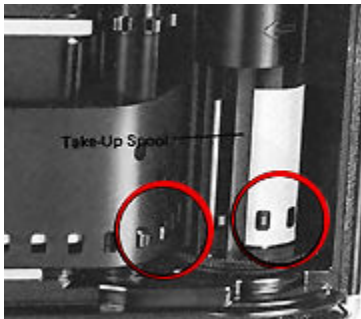

Then, make sure that there is no film slack. In case there is, gently turn the film rewind crank in the direction of the arrow to obtain proper film tautness and the film advance lever to ensure that the leader is wound fully on to the take-up spool before the camera back is closed.

When loading the film into the camera **do not** touch the shutter curtain, the film rails or the pressure plate. The shutter curtain is a most delicate and fragile part in the camera, a deformed shutter curtain may result in a permanent damage and since the AE-1 may not have any support in replacement parts from Canon, always handle loading and unloading of film roll carefully.

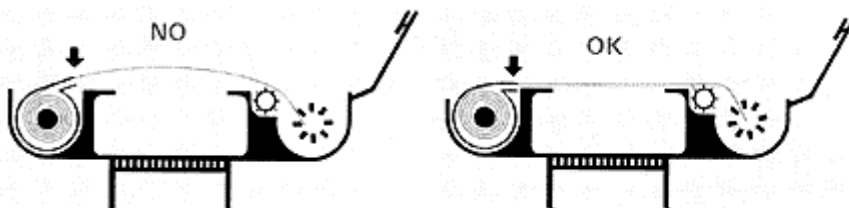

Closing the Back Cover

Close the back cover until it snaps shut. Gently turn the film rewind crank clockwise in the direction of the arrow to take up the film slack. Then, advance the film a couple of times pressing the shutter button until the first exposure appears in the frame counter.

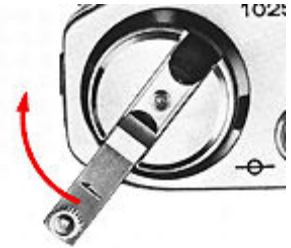

Checking Film Winding

Operate the film advance lever while watching the film rewind knob. If it rotates, the film is properly loaded. If the rewind knob does not rotate, open the back cover and load the film again from the start.

Setting the ISO Film Speed



After loading the film, set the ISO film speed according to the ISO speed of the film in use.

To set the ISO, first push the film advance lever out to its 30° stand-off position away from the camera body, then lift up the ISO ring around the shutter dial and rotate it in either direction until the proper number is aligned with the green index mark. ISO is a numerical rating of a film's sensitivity to light. A higher ISO number indicates a faster film which is more sensitive to light. On the other hand, a lower ISO number indicates a slower film which is less sensitive to light. The ISO rating recommended by the manufacturer is printed on the film box, e.g., ISO 100.

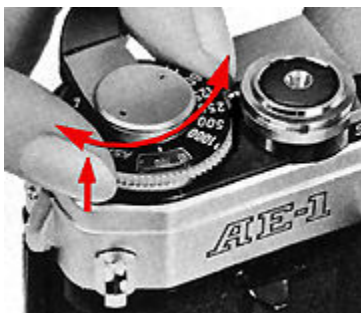

The following ISO ratings can be set on the camera. Figures in parentheses indicate intermediate film speeds.

ISO 25 | 32 | 40 | **50** | 64 | 80 | **100** | 125 | 160 | **200** | 250 | 320 | **400** | 500 | 640 | **800** | 1000 | 1250 | **1600** | 2000 | 2500 | **3200**

Use of the Memo Holder The memo holder on the camera's back cover is useful for keeping data like film speed, location, shooting.



For example, after tearing off the part of the film box which specifies the type of the film being used, it can be inserted into the memo holder as a constant reminder. Personally, I used the memo holder to put an ID-size photo of my girlfriend.

Film Advance and Shutter Release Turn the film advance lever until it stops, so the film will advance one frame all in one motion. The shutter will cock, and the diaphragm and mirror will be ready for the next shutter release, while the frame counter advances simultaneously to the next number. By pushing the film advance lever lightly with the tip of your thumb, it will open to its 30 stand-off position away from the camera body for easy film advance. While the film is advancing, the shutter will not be released.

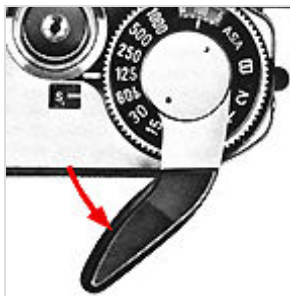

Film winding can also be accomplished by advancing the lever in short strokes.

Canon has developed the Power Winder A to be used with the AE-1 for automatic film winding. It greatly increases the automation and mobility of the AE-1.

Shutter Button and Shutter Lock The shutter release button is designed to function as the main switch of the camera to activate the AE meter and shutter operation. The shutter has a magnetic release, so the meter can be read by pressing the shutter button halfway with light pressure. By depressing it further, the shutter will be released.



The magnetic release shutter button enables faster metering for shooting in succession than the mechanical release method does. There is also less chance for camera shake.

When the shutter lock lever around the shutter release button is turned to the "L" position, the shutter button will be locked to prevent unintentional shutter release. Keep the shutter release button locked while carrying the camera to prevent film waste. Note: When the power level of the battery is insufficient, a safety mechanism will keep the shutter from being released.

Frame Counter



The frame counter is an additive type which counts one frame every time the film advance lever winds the film. When the camera's back cover is opened, the frame counter automatically resets itself to the "S" position.

The shutter release button is designed to function as the main switch of the camera to activate the AE meter and shutter operation. The shutter has a magnetic release, so the meter can be read by pressing the shutter button halfway with light pressure. By depressing it further, the shutter will be released. The magnetic release shutter button enables faster metering for shooting in succession than the mechanical release method does. There is also less chance for camera shake. While rewinding film, the frame counter counts back the frame numbers. The starting position "S", 0, and the even numbers 2 to 38 are displayed by the counter. Numbers 20 and 36 are marked in orange to call your attention to the end of film cartridges such as are today commercially available. The frame counter cannot count higher than 38.

Operation for General Photography The AE-1 is an Automatic Exposure camera with a shutter speed priority system which electronically controls the aperture opening for the given shutter speed to ensure the optimum exposure. Canon's shutter speed priority system has been adopted by this camera in the idea that a photograph is an instant snatched from elapsing time. The shutter speed priority system is ideal for catching fast-moving subjects, especially at the decisive moment. Even most of the models in Canon's EOS System of AF cameras have this shooting mode a standard feature. Furthermore, the shutter speed priority system allows you to control image blur at will and to emphasize the movement of the subject. For action or other such situations, you can realize all photographic aspirations.

Setting the Shutter Speed The shutter dial controls the length of time that light is allowed to reach the film. On the shutter speed dial, shutter speeds from 1/1000 to "B" are marked in white, while the 2-second speed is marked in orange. Each shutter speed gradation is twice or approximately twice the preceding speed, beginning with 1/1000 sec. (1000).

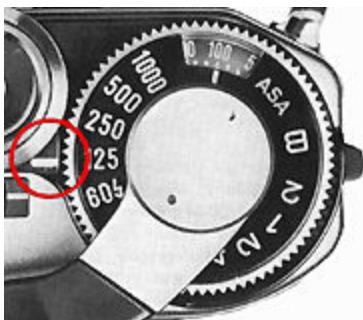

Thus, the light reaching the film at 1/250 second is half the light reaching it at 1/125. The numbers on the shutter speed scale represent the corresponding fraction of a second ($125=1/125$), with the exception of 1 and 2 (marked in orange) which stand for 1 and 2 seconds respectively.

The "B" setting is for long exposures. At the "B" setting, the shutter remains open while the shutter button is depressed and closes when it is not depressed. See page 48 for more details concerning long exposures. To set the shutter speed, rotate the dial in either direction until the desired number clicks into place next to the white index mark. An in-between shutter speed cannot be set on the dial.

Rotated between "B" and "1000".	
Brightness	Shutter Speed (Seconds)
Indoor	1/30 sec to 1/60 sec
Outdoor	1/125 sec to 1/1000 sec
Mid-summer Beach Snow-covered Mountains	1/500 sec to 1/1000

a) Selecting the Shutter Speed Shutter speed is determined in accordance with the brightness of the scene and the speed with which the main subject is moving. You can use the above table as a general guide to help you select an appropriate shutter speed when using a standard 50mm lens. For indoor photography, with no special illumination, choose 1/30 of a second and 1/60 of a second in a brightly lit room.

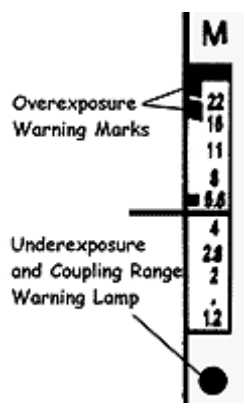

For out door photography, select 1/125 second when cloudy and 1/250 second in sunshine. To take pictures in particularly bright sunshine such as at a beach in midsummer or in snow-covered mountains, use shutter speeds of 1/500 sec. or 1/1000 sec.

The above mentioned shutter speeds apply when using a standard 50mm lens, but it is necessary to choose faster shutter speeds when using lenses of longer focal lengths because they are more difficult to hold steady. It is generally said that the shutter speed figure should be greater than 1 divided by the focal length of the lens in order to obtain sharp images. For example, when using a 200mm telephoto lens, shutter speed. should be faster than 1/200 second, therefore the shutter speed in this particular case should be set at 1/250 sec. Image blur can also arise if the camera is not properly held.

b) Reading the Exposure This camera incorporates a magnetic release system using an electromagnetic switch to effectively perform instantaneous light metering. The shutter release button activates light metering and exposure in succession and practically simultaneously. This is a two-step shutter button. The exposure can be confirmed by the meter

needle inside the viewfinder by pressing the shutter button halfway. When the meter needle inside the viewfinder stays within the proper range and the underexposure warning LED lamp below the aperture scale inside the viewfinder does not blink, the exposure is correct.

When the underexposure warning lamp inside the viewfinder blinks, or when the meter needle moves into the upper overexposure warning zone in red, the exposure is incorrect. When this is the case, turn the shutter speed dial until the meter needle inside the viewfinder moves into the proper exposure range. To confirm this, turn the shutter speed dial while looking into the viewfinder and pressing the exposure pre-view switch at the same time. It is convenient to turn the shutter speed dial with your forefinger in order to swiftly cope with the speed of fast moving subjects. When using shutter speeds slower than 1/30 second, the camera should be placed on a tripod to avoid the possibility of camera shake.

c) Viewing and Focusing Focusing is performed in the small round area in the center of the viewfinder. The smaller central circle is a split-image focusing screen and around it is the microprism ring. The split-image rangefinder ascertains that the image is "in focus" when the image divided horizontally in half matches and becomes one complete image.

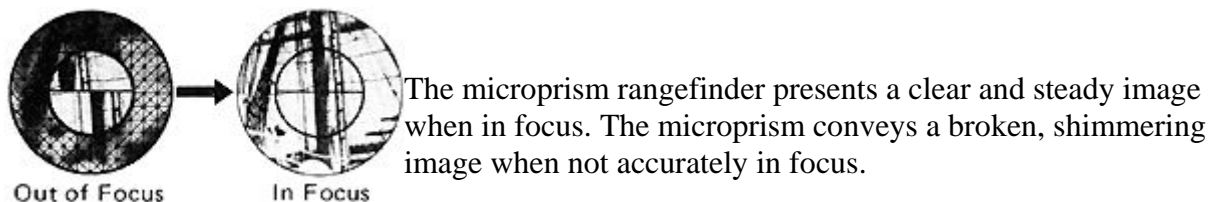

It is also possible to focus with the matte screen outside the smaller central area. You can focus with either of these focusing aids as you like, depending on the subject condition and your preference.

Dioptric Adjustment Lenses Dioptric adjustment lenses can be attached by inserting them from above into the grooves in the viewfinder eyepiece to compensate for the individual eyesight. With them, near-sighted or far-sighted persons can perform photography without glasses.

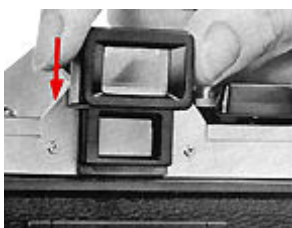

The built-in eyepiece lens of the AE-1 has -1 diopter. The following 10 kinds of dioptric adjustment lenses are optional accessories: +3, +2, +1.5, +1, +0.5, 0, -0.5, -2, -3, -4 (diopters).

Accessories such as an eyecup, dioptric adjustment lenses, angle finders, and magnifier can be attached to the viewfinder eyepiece.

One way of selecting the correct dioptric adjustment lens for you is to select the one that is the closest to your glasses in regard to number of diopters. But, we propose that, when you select the most appropriate dioptric adjustment lens, you actually look into the viewfinder through it after placing it over the eyepiece.

Note: Because the camera itself has -1 diopter, the diopters of the lenses are recorded as the real power when attached to the camera, thus reflecting the power of the camera's viewfinder.

Angle Finder A2 and B The angle finder is a magnifying glass which can be attached from above into the grooves of the viewfinder eyepiece. It rotates 90 degrees so that the image on the viewfinder can be viewed directly from the side or above whenever it is inconvenient or impossible to look directly through the eyepiece.



This is very helpful in copying, close-ups, macrophotography, and photomicrography. There are two types, the A2 whose image is reversed as in a mirror, and the more advanced Angle Finder B with the normal camera image.

Magnifier S The Canon Magnifier S gives 2.5X magnification of the viewfinder center for precision focusing in close-up work. The strength can be adjusted to your eyesight within the range of +4 to -4 diopters.



The Magnifier S combined with its adapter can be inserted into the grooves of the viewfinder eyepiece. The adapter of the Magnifier S is hinged to allow the magnifier to swing upward from the eyepiece leaving the whole screen image visible after focusing.

Holding the Camera Unlike the mechanical release system, the magnetic release system of the Canon AE-1 electronically controls the shutter. The shutter button moves with a very light touch and its travel is very short. The shutter will be released by lightly depressing the shutter button so as to prevent camera shake. But, unsteady holding of the camera will cause camera shake in spite of the magnetic release system. Therefore, be sure to hold the camera firmly. Rest the camera on your left palm and grasp the lower part of the lens focusing ring between your thumb and forefinger or middle finger. Hold the right end of the camera firmly, with your right thumb behind the tip of the film advance lever and your right forefinger on the shutter button, while the other fingers hold the camera's finger grip.

To reduce camera shake, press your left elbow strongly against your body and look into the viewfinder steadying the camera against the forehead. The right arm should be relaxed while holding the camera. When you use comparatively slow shutter speeds or when you use telephoto lenses, it is advisable to lean against a wall, a tree trunk or some fixed object for a steadier grip.



Adapter A for Tripod

When using a lens of considerable overall length, depending on the tripod being used, it may be difficult to hold the adjustment in the case of accidental bumping of the lens. In such cases, the Canon Adapter A for Tripod with a rubber matte should be placed between the tripod and the camera for easier handling.

Composition Since the AE-1 has automatic exposure control with shutter priority, you can concentrate on the actual picture you are going to take without worrying about exposure differences that may occur with changing subjects. Viewing is performed through the lens, and there is no difference between the viewfinder image and the image exposed on the film as opposed to the image provided by a separate viewfinder which is affected by the parallax between the viewfinder and the camera lens.

Releasing the Shutter The Canon AE-1's shutter button uses a magnetic release system. The shutter button travel is very short and activated by a very gentle touch. When you press the shutter button, try to squeeze the shutter button gently with your finger.



Avoid hitting or pressing the shutter button suddenly particularly when using slow shutter speeds, otherwise blur may result.

At the moment of shooting, you should hold your breath while the shutter button is being pressed.

Rewinding the Film When the film advance lever cannot travel all the way to the end of its stroke, the frame counter tells you that you have reached the end of the film. You have to rewind the film in its protective cartridge, before you can remove it from the camera.



You must not open the camera before rewinding the film. Since it is not protected, any exposure to light will "fog" the film and cause a drastic color shift and loss of picture image.

To rewind the film, press in the small rewind button on the bottom of the camera, unfold the rewind crank and turn it in the direction of the arrow on top of the rewind knob. When the frame counter has reached the "S" mark, you should stop rewinding. Then pull up the rewind knob to open the camera back and lift the cartridge out.

If you stop rewinding the moment the frame counter has reached the "S" mark, the film will not be completely rewound into the cartridge and the film leader may still be outside the cartridge.

Double-Check Before Shooting If you hurry to release the shutter, you may make an unexpected error due to carelessness. The following points should be double checked:

1) Is the aperture ring of the lens set to the "A" mark?

Press in the EE lock pin while turning the aperture ring to the "A" mark. This specific setting is a requisite for beautiful color pictures with automatic exposure. If you fail to adjust the aperture ring to this setting when appropriate, the correct automatic exposure will not be obtained. When the aperture ring of the lens is not set to the "A" mark, the manual aperture control "M" signal above the aperture scale in the viewfinder flash has on and off as a warning that the aperture ring is not set at the "A" setting.

2) Did you set the film speed properly?

It is necessary to set the film speed properly according to the film in use in order to obtain the correct exposure.

3) Is the film properly loaded?

You can use the rewind knob as an indicator that the perforations of the film are properly engaged on the sprocket and the film is actually advancing. Every time you advance the film, the rewind knob should turn.

Detailed Operation of the AE-1

A silicon photocell is used as the photosensitive element in the camera. If you compare the silicon photocell (SPC) with other existing photo-sensitive elements, you will find it covers a greater range of lighting situations and allows for greater accuracy. In order to provide the AE-1 with the best possible magnetic release system, Canon developed a special circuit for instantaneous light metering. Due to this innovation, even in place as dark as EV1 (at ISO 100, f/1.4, 1 sec.), metering can be performed in only 0.04 second.

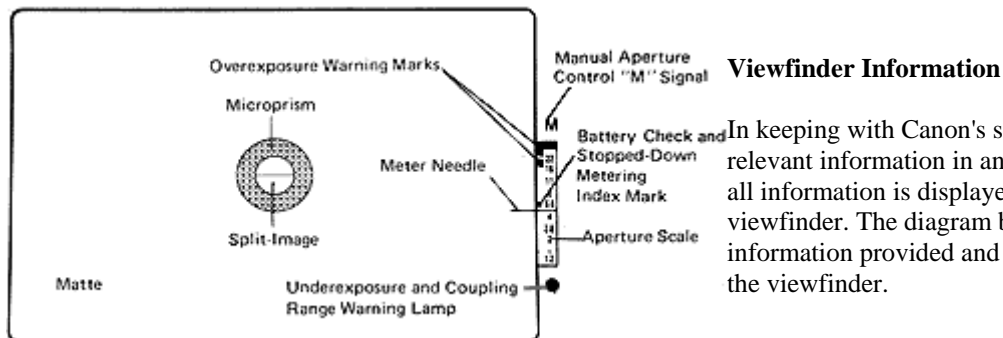

Meter Sensitivity Pattern



In a great variety of lighting situations, the carefully designed Central Emphasis Metering system simplifies problems to ensure that the subject is correctly exposed.

Metering Range

TTL metering is possible with a f/1.4 lens at ISO 100 from EV 1 (1 sec., f/1.4) to EV 18 (1/1000 sec.. f/16).

ASA Film Speed	Coupling Range
25..50	2 to 1/1000 sec
..100	1 to 1/1000 sec
..200	1/2 to 1/1000 sec
..400	1/4 to 1/1000 sec
..800	1/8 to 1/1000 sec
..1600	1/15 to 1/1000 sec
..3200	1/30 to 1/1000 sec

Shutter Speed and AE Coupling Range The shutter speed and AE coupling range are indicated in the table. If any combination outside the coupling range is made, the coupling range warning lamp will blink, as it does when warning of underexposure. Since the lamp serves a dual function, check that the shutter speed IS within the coupling range before assuming that the light level is too low.

Overexposure Warning Mark When the lighting of the subject is too bright, the meter needle will rise into the red zones of the aperture scale. The red area is divided into two parts. The top part is a warning for use with a lens having a minimum aperture of f/22, while the bottom part is for use with a f/16 minimum aperture lens. When the meter needle enters the red area, increase the shutter speed and correct the exposure.

Note: With some specific lenses like the FD 100mm f/4 Macro lens, which offers a minimum aperture of f/32, if you want to photograph at its minimum aperture of f/32 and the meter needle points to the red area, do the following: Increase the shutter speed until the meter needle indicates f/22 and then decrease the shutter speed by one gradation so that the exposure will be correct.

Underexposure and Coupling Range Warning LED Lamp This lamp blinks on and off as a warning of incorrect exposure. If you reduce the shutter speed by turning the shutter speed dial so the underexposure warning lamp will stop blinking, the correct exposure will also be obtained. Under dim light with a slow speed lens, there is a case when the meter needle will point at the aperture scale inside the viewfinder although it will exceed the maximum aperture of the lens. In this case, turn the shutter speed dial to a slower setting so that the underexposure warning lamp stops blinking.

For example, when you use an f/2.8 lens and the meter needle exceeds the aperture scale of f/2.8 inside the viewfinder, reduce the shutter speed until the lamp stops flashing. When the shutter is set at 'B' (Bulb) and the shutter button is pressed halfway, this warning lamp will also flash on and off.

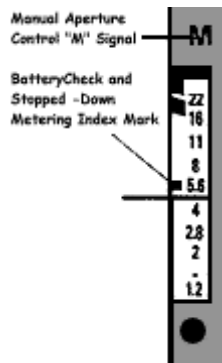

Battery Check and Stopped-Down Metering Index Mark

This battery check index mark serves also as the stopped-down metering index mark for use with Canon FL lenses and other similar manual lenses, when exposure measurement is performed with a stopped-down diaphragm.

Manual Aperture Control "M" Signal (LED) When the aperture ring is not set at the "A" mark, you cannot get the correct exposure in AE photography. When the aperture ring is set at any position other than the "A" mark, the manual aperture control "M" signal will blink as a warning. Also, when Canon FL lenses, Bellows or the like are used, this warning signal flashes on and off when exposure measurement is performed.

Concerning the Exposure (Shutter Speed and Aperture Coupling) In order to obtain the correct exposure, it is necessary to correctly match the shutter speed with the aperture. The shutter speed and the aperture are the main factors in controlling the amount of light which is allowed to strike the film, and when they change, the quality of the image upon the film also changes.

1) Effects of Changing the Shutter Speed The explanations below are pertinent to photography with fast moving subjects or when it is intended to convey the feeling of movement in a photograph. If, as in example, a photo is taken at a shutter speed of 1/250 sec. and above, the movement will be frozen. If, with the same subject, the photo is taken at a speed of 1/60 sec. though the subject is somewhat blurred, movement is well expressed. It is only a matter of aesthetics as to which of these photographs is the best. Depending on the selection of the shutter speed, you can freely control the expression of movement.

2) Effects of Changing the Aperture Because this camera is an AE camera with shutter speed priority, when you change the shutter speed, the aperture will also change. If you change the speed by one gradation, the aperture also changes the equivalent of one gradation. Aperture changes have an effect on the photographic expression as follows: The lens aperture controls the zone of sharpness in the subject field which is observed in the viewfinder or recorded on the film.

Aperture Priority Photography After having given careful thought to the results of aperture adjustments, when the f/stop has been determined before shooting, press the exposure preview switch while looking into the viewfinder. Then turn the shutter speed dial until the meter needle on the right of the viewfinder reaches the f/stop desired.

Depth-of-Field When a certain subject is brought into focus, there is only a limited range in the foreground and background of the subject which can be kept clearly in focus. This zone of sharpness in the subject field is depth-of-field.



There are two methods of confirming the extent of the depth of the field: by stopping down the lens diaphragm or by reading a value from the depth-of-field scale on the lens.

Confirming the Depth-of-Field by: 1). Stopping-Down the Lens Diaphragm. Wind the film and determine the aperture required for the subject by metering, and then set the f/stop by turning the aperture ring after disengaging the aperture ring from the "A" mark. **2).** Press the stopped-down lever until it locks. Once locked, the depth-of-field can be checked by looking into the viewfinder. Thus, the extent of the depth-of-field can be seen as the zone of sharpness in the subject field observed on the screen. When the stoppeddown lever's release button is pressed, full aperture metering will be restored.

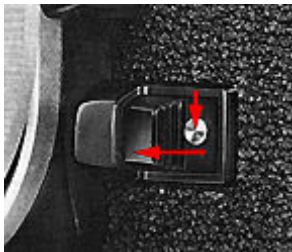

3). After having turned the aperture ring to the maximum f/stop on the lens, reset it to the "A" mark. Otherwise, you will not be able to obtain the correct automatic exposure for the next shot.

Stopping-down of the FD lenses should only be done after advancing the film. Should you not advance the film, the stopping-down of the lens diaphragm would only be possible up to the previous exposures aperture. Also, when the aperture ring is set at the "A" mark, the stopped-down lever cannot be pressed.

Generally, the depth-of-field will become deeper as the aperture becomes smaller, and shallower as the aperture becomes larger. A shorter focal length as well as a greater subject distance will also attain deeper zone of depth-of-field. Comparing an interchangeable 28mm lens with a standard 50mm lens set at the same f/stop, the 28mm lens's depth-of-field will be greater. And when the photographic distance changes, the depth-of-field changes, too. For example, if the same subject is photographed from three and then from seven meters away, the foreground and background of the subject will be deeper at the greater distance.

4) Depth-of-Field Scale on the Lens Most manual focus lenses has excellent depth-of-field scale engraved on the lens barrel, shown as a series of f/numbers on each side of the distance index mark opposite the distance scale. Focusing and depth-of-field are so closely interrelated that the depth of-field scale is engraved together with the distance scale. You can tell the extent of depth-of-field from the distance scale.

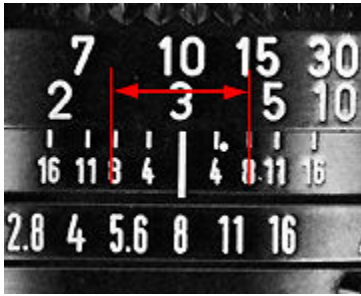

For example, if you use the camera with a standard 50mm lens that is focused on a subject at medium distance, say 3m with the aperture set at f/8, the depth-of-field extends from 2.4m to 4.5m. This tells you that with the 50mm lens focused at 3m and the subject between 2.4m and 4.5m the film image will be reasonably sharp.

Using the Self-Timer Obvious uses for the self-timer are self-portraits and the inclusion of the photographer in the picture. The self-timer, though, can also be used in place of a cable release to release the shutter gently and smoothly in close range work like photomicrography or copying. Push the electronic self-timer lever forward, then press the shutter button, and the shutter will be released 10 seconds later. The camera memorizes the exposure value the very instant the self-timer is activated by pressing the shutter button. While the self timer is in operation, the self-timer lamp flashes on and off. After you finish taking a picture the self-timer lever should be reset to its original position. **Otherwise, it will function again** the next time you press the shutter button.

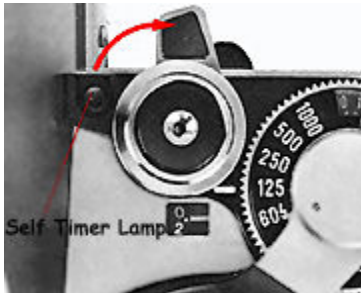

Exposure will be automatically determined at the instant the shutter button is pressed, and not when the picture is actually taken. Therefore, **avoid** standing directly in front of the lens when you press the shutter button as the AE control may miscalculate the proper exposure.

To prevent stray light from entering the viewfinder from the rear and possibly affecting the meter reading, it is a good idea to cover the eyepiece with the viewfinder cover which is inserted into the accessory shoe. This cover can be attached to the holder on the viewfinder eyepiece. After doing so, press the shutter button.

Canceling the Self-Timer Operation If you should want to cancel the self timer operation after having pressed the shutter button, depress the battery check button on the top side of the camera. Then, the self-timer lamp stops blinking and the self-timer operation will be cancelled. If the battery check button is not depressed and the self-timer lever is returned to its original position, the shutter will be released.

Shooting Against the Light with the Backlight Control Switch In most cases, the Canon AE-1's Central Emphasis Metering system will give correct exposure readings in AE photography. However, you will occasionally encounter 'abnormal' or unfavorable lighting situations in which normal AE photography would not provide a correct exposure reading of the main subject. For example, in situation where your subject has strong light behind it or the subject contrasts sharply with the background or the composition is such that it does not appear in the center of the picture or the entire scene is either extremely bright such as a light-colored subject in snow, a white wall or on a sunny beach.

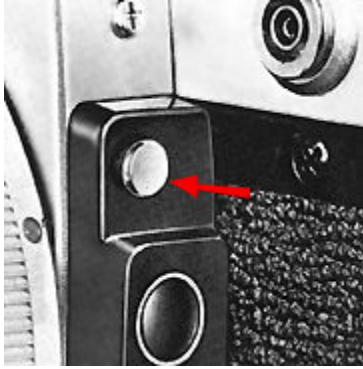

In the above cases, it is necessary to modify the automatic exposure reading that the camera automatically sets. If calculation of exposure compensation is too complicated, the AE-1 has a convenient feature in backlight exposure compensation button. You can correct the exposure reading by pressing the backlight control switch which will increase the exposure value by the equivalent of one and a half f/stops.

Long Exposures and "B" (Bulb) Setting

When you need shutter speeds slower than two seconds such as for shooting night scenes or fireworks, set the shutter speed dial at "B". Then, the shutter will remain open as long as the shutter button is pressed. In long exposures, it becomes essential to mount the camera on a tripod and use a cable release preferably with a lock to prevent camera shake and attain best results.



A cable release with a locking device can keep the shutter open even though the operator leaves the cable release unattended. Unlock the cable release when the shutter should be closed.

Warning: Since the electronic AE-1 does not operate any of its shutter settings mechanically, photography using the "B" setting will accelerate battery consumption since it requires continuous battery power. When necessary, the battery should be replaced with a new one having a full charge.

Stopped-Down Metering

When the AE-1 is used with Canon FD lenses, photography can be performed with through-the-lens (TTL) metering and with AE coupling. However, with the Canon FL lenses and most earlier non-auto coupled accessories such as bellows, extension tubes, or a microscope adapter, it is necessary to take a stopped-down meter reading.

Warning: The FD lenses with auto diaphragm mounted on the AE-1 should always be used with full aperture metering. Using stopped-down metering with FD lenses on the AE-1 will give the wrong exposure. Skip this section if your optics are FD or New FD-type of lenses.

Stopping down the lens can be done by pushing the stopped-down lever until it locks. When the lenses is stopped-down, press the shutter button halfway or depress the exposure preview

switch and adjust the aperture ring and/or shutter speed dial until the meter needle inside the viewfinder is aligned with the stopped-down metering index mark. Press the shutter button and the photograph will be perfectly exposed. If the lens should be mounted on the camera with the stopped-down lever locked, correct exposure will not be obtained. In this case, a red warning mark by the stopped-down coupling lever inside the camera body is visible. After removing the lens, on the lower part of the camera body, just below the mirror, this stopped-down coupling lever becomes visible, as does the red mark in the case described above.

Manual Aperture Control

When accessories requiring manual aperture control are used between the camera body and a lens, lock the automatic aperture lever in the manual position before mounting the lens.

A) Lock for Manual Aperture Control (1) For manual aperture control, push the automatic aperture lever counterclockwise until it stops and locks. When accessories such as extension tubes are attached to a lens that has been set for manual control, the diaphragm blades of the lens open or close as the aperture ring is turned. To revert from manual control, reset the automatic aperture lever in its original position.



B) Lock for Manual Aperture Control (2)

There are some FD lenses with the manual lock lever requiring a different procedure for manual control setting.

With these particular lenses, the automatic aperture lever must be turned fully counterclockwise while the manual lock lever is brought to the "L" position. Once this has been done, when the lens is mounted on the camera, the diaphragm blades will open or close by turning the aperture ring. To revert from manual aperture control, reset the manual lock lever at the position of the white dot.

C) Lock for Manual Aperture Control When Using the Macrophoto Coupler (3) In close-up photography of high magnification with a lens reversed on the Macrophoto Coupler, the automatic diaphragm mechanism is not coupled. You must, therefore, remember to close down the diaphragm manually after having locked the automatic aperture lever in the manual position as explained above in (1) and (2). Then, fix the Macrophoto Hood on the lens mount by turning the bayonet ring.



When you are taking stopped-down meter readings, the manual aperture control "M" signal above the aperture scale inside the viewfinder flashes on and off only when the shutter release button is depressed halfway.

Changing the Lens Earlier FD lenses (With inner chrome ring) incorporate a safety mechanism to prevent the bayonet ring and the diaphragm blades from moving when the lens is not mounted on the camera. To bypass this safety mechanism, press the lock pin in the top recess of the bayonet mount while turning the bayonet ring. Once this safety mechanism has thus been cancelled, you can see the diaphragm blades move when activated. Note: Later FD lenses (those with the black ring) need not have to lock the chrome ring. Since FD lenses have signal pins and levers which couple with the camera body, special care must be taken not to damage them. One basic precaution is to always put the lens down facing down whenever you must change lenses.

The following lenses **cannot** be used with the built-in meter because the extended rear part of the lens will push in the lens speed adjustment pin on the camera body: **FL 19mm f/3.5 FL 35mm f/2.5 FL 50mm f/1.8 FL 58mm f/1.2 R 35mm f/2.5 R 50mm f/1.8 R 100mm f/2.**

Lens Signal Coupling Aperture Signal Lever

This lever transmits the actual f/stop to the exposure meter. It is coupled to the aperture ring just the same as when the aperture ring is not set at the "A" mark.

Full Aperture Signal Pin This pin transmits the signal corresponding to the lens at the full aperture opening.

Automatic Aperture Lever This lever closes down the aperture, coupled with the stopped-down coupling lever.



EE Switch Pin

This pin protrudes when the aperture ring is locked at the "A" mark. In this position, it transmits a signal for AE photography.

Reserved Pin

This pin is designed for use with accessories that may be developed in the future.

Film Plane Indicator

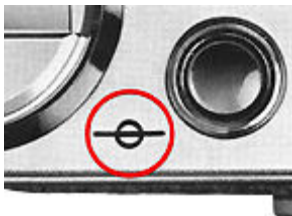

This mark is engraved on the top of the camera between the film rewind crank and the battery check button, just to the left of the pentaprism, to indicate the exact position of the film plane. The distance scale on the lens shows subject distances measured from the film plane indicator. This mark is not used in general photography, but in close-ups and macrophotography it is often used to obtain the exact subject distance.

Scales on the Lens - Aperture Scale The aperture of the lens is the opening of the diaphragm blades, like the iris of the human eye. It controls the amount of light passing through the lens to the film surface.

Brightness (f/stop)	1.2	1.4	2	2.8	4	5.6	8	11	16
Ratio	3	2	1	1/2	1/4	1/8	1/16	1/32	1/64

The f/number is a numerical expression of the effective aperture. It is obtained by dividing the focal length of the lens by the diameter of the effective aperture. When the f/number is set one scale gradation higher, the lens allows in half the light it would at the previous gradation. Intermediate settings of the aperture scale can be used, too. In some lenses, the f/number setting one gradation higher than the first f/number setting does not necessarily allow only half the amount of light of the previous setting through the lens to expose the film as is the case at the other settings. This should be taken into consideration when necessary.

Distance Scale The distance scale is for distances measured from the film plane. This scale is not generally used except for confirming the depth-of-field, performing guide number calculations in flash photography, or photographing with infrared film. Read one-digit distances in the middle of the number marked on the scale. Two-digit distances should be read at the point in the middle of the two digits.

Depth-of-Field Scale You can determine the depth-of-field by checking the depth-of-field

scale and the distance scale on the lens barrel. Both are closely interrelated.

Infrared Index Mark The red dot infrared index mark engraved on the lens barrel is a focusing correction index mark for infrared film. Because infrared light rays have longer wavelengths, they focus on a plane slightly behind that of ordinary visible light rays.



Therefore, it is necessary to slightly modify the normal method of focusing the lens. After focusing the same as usual, note the tiny red dot engraved on the lens barrel just to the right of the distance index and turn the focusing ring slightly to align the focused distance with this red dot.

For instance normally, when the focus is adjusted at 5m on the distance scale, you turn the focusing ring slightly so that the 5 on the distance scale matches the red dot infrared index mark. When photographing with infrared black and white film, visible light rays must be kept out by means of a deep red filter (R1) over the lens. Set the aperture ring manually following the film manufacturer's suggestion for exposure settings. However, this does not apply when color infrared film is used' so please follow the directions of the specific instructions of the film manufacturer when performing infrared color photography. The infrared index mark is engraved in a position based upon the conclusion arrived at through experiments that the film most sensitive to the 800m,μ wavelength is to be used with a red filter. For example, the Kodak Film IR135 and the Wratten Filter 37.

Speedlites, Accessories, Care, Maintenance and other issues.



The versatile circuitry of the Canon AE-1 allows it to perform fully automatic flash photography with the Speedlite 155A especially designed for this camera. It is not necessary to set the shutter speed or the aperture on the camera as, up to now, flash photography required. When the 155A is attached to the AE-1, set the aperture ring of the lens to the "A" mark and the shutter speed dial to any position other than "B" (Bulb). With the pilot lamp of the 155A lighting up, the 155A functions to automatically adjust the camera's shutter speed to the X synchronization speed as well as the aperture to the prescribed f/stop value.

After it flashes, the camera automatically switches over to the AE photography mode until the pilot lamp lights up again during which period AE photography can be continued. A steady support may be required if shutter speeds are slower than 1/30 of a second. Like ordinary flash units, you can also perform flash photography by operating the aperture ring manually. When you are using a Canon FL lens which does not allow full aperture metering, automatic flash photography can be performed by setting the prescribed f/stop on the lens manually. In both cases, the shutter speed is automatically adjusted to the X synchronization speed of 1/60 sec. As the time of its introduction, there is a 'dedicated' flash unit in Speedlite 155A, which uses a unique averaged light sensing system which keeps down the distribution of the reflected light

from the center, the influence of the background is greatly reduced. Thus, the 155A offers more appropriate exposure than the present some other third party flash units do.

Moreover, when the main switch of the Speedlite 155A is turned off, the flash circuitry is completely cut off and the AE-1 switches over to function as an AE camera even when the 155A is mounted on it. However, there are many flash units produced by Canon that followed which can offer similar capabilities, so you don't have to purposely hunting specifically for the 155A in the used market.

Flash Photography with the AE-1 Flash Synchronization: X Synchronization Speed (1/60 sec.) 1. When the AE-1 is used with the Canon Speedlite 155A, the shutter speed is **automatically adjusted to the X synchronization speed** at the time the pilot lamp lights up. When the AE-1 is used with other flash units, the shutter speed should be manually set at 1/60 sec. 2. **Flash Terminal:** The AE-1 offers a choice of two kinds of flash terminals; one is a directly coupled contact of the hot shoe type, and the other is of the B type terminal, as determined by Japanese Industrial Standards (JIS) for use with flash units with a cord. When both flash terminals are used, two flash units can be fired simultaneously. 3. **Flash Synchronization Range:**

Synchronized shutter speed		1/1000	1/500	1/250	1/60	1/30	1/15	1/8	1/4	1/2	1	2	B
Type													
Flash Bulbs	FP class					△	○	○	○	○	○	○	○
	M and MF class					△	○	○	○	○	○	○	○
Electronic Flash					○	○	○	○	○	○	○	○	○

(△ mark indicates possible unevenness in the picture depending on the flash bulb.)

When the camera is used with a flash unit other than the Canon Speedlite 155A or any other similar class Canon Speedlites, be sure to set the shutter speed at 1/60 sec or below and the aperture **manually** to the aperture to the f stop prescribed for automatic flash photography or to a proper f/stop as indicated by guide number calculation.

Canon Power Winder A Winder A2 The Canon AE-1 is a very compact, lightweight camera whose main functions respond to the electronic circuitry built into the camera body. It is possible to photograph just the same as in general photography even when the Canon Power winder A is attached. The Canon Power Winder A is an automatic film winder which makes the functions of automatic photography of the Canon AE-1 outstandingly effective. It can be attached to any Canon AE-1 directly, without any other accessory or attachment. When you attach the Power Winder A to the Canon AE-1 and press the shutter button, the film will be immediately wound after being exposed.



Furthermore, with the Power Winder A you can catch subjects' movements and changing expressions because you are able to take continuous or single frame photography at your pleasure. When you perform continuous photography, the Power Winder A couples with shutter speed from 1/60 to 1/1000 seconds while, in single frame photography, any shutter speed can be used.

The Winder A has an upgrade later in Winder A2 (Introduced with the AE-1 Program in 1981) which can be used on the earlier Canon A-1 and all other models within the A series (As well as the flagship model, Canon New F-1!). It is also compatible with the AE-1. However, the AE-1 was **not** designed to use with the later **Motor Drive MA**, but the upgrade AE-1 Program was able to share with the Motor Drive MA which primarily designed for the Canon A-1.

Data Back A This is an interchangeable back cover with a built-in data imprinting mechanism. It can imprint the day, month and year on the lower right hand corner of the photograph at the moment of the shutter's release, as well as other data to identify or classify the pictures you take.



It has letters and Roman numerals for greater versatility and convenience. **Warning:** (**Make sure** you understand the databack before you make a purchase at the used market - the input dial of the original databack for 'Year' 'expired' around 1987).

Canon Bellows FL Older (And cheaper) FL bellows can be considered as accessory. This is an adjustable bellows for high magnification photography. Magnification is adjusted within the range of about 0.7 to 3 times the size of the subject when it is used in combination with a standard lens.



The built-in semi-automatic aperture mechanism automatically closes the diaphragm at the time of shooting and makes the Bellows FL almost as easy to use as a fully automatic lens. Focusing is performed with a bright field of view. It has a built-in strut to prevent blur. The Slide Duplicator FL for duplicating slides can be attached to the end of the Bellows.

The use of a macro lens especially corrected for close-up photography is particularly recommended for photography with the bellows (Majority of the newer accessories designed for A-series bodies can be shared as well).

Accessories:

- | | |
|--------------------------------|--|
| 1. Angle Finders A2 and B | 13. Canon Release 30 |
| 2. Eyecup S | 14. Canon Release 50 |
| 3. Magnifier S | 15. 55mm filters 58mm filters |
| 4. Camera Holder F2 | 16. 58mm Close-up Lenses (240, 450, 1800) |
| 5. Macrophoto Coupler FL55, 58 | 17. 55mm Close-up Lenses (240, 450) |
| 6. Lens Hood BS-55 | 18. Copy Stand 4 |
| 7. Microphoto Hood | 19. Bellows M |
| 8. Photomicro Unit F | 20. Bellows F L |
| 9. Slide Duplicator | 21. Extension Tube M Set |
| 10. Handy Stand F | 22. Dioptic Adjustment Lenses for Eyesight Compensation (10 kinds) |
| 11. Gadget Back 4-type | 23. Speedlite 155A |
| 12. Gadget Back G-1 | 24. Power Winder A (A2) |
| | 25. Data Back A |

The camera is provided with the following (But don't expect these items will be as complete when you acquired a AE-1 as used unit): **Body:** Soft Case, Viewfinder Cover, Silver Oxide Battery, Eyecup 4S, Flash Terminal Cap, Camera Cover RF, Neckstrap 7, Spare Battery Case, and Adapter A for Tripod. **Lens:** Lens Cap and Dust Cover.

Care and Storage of the Camera No matter how exceptional the camera may be, it will not give you all it can unless it is taken care of properly. Please make sure to keep the camera clean all the time. Acquire a blower brush, cleaning liquid, cleaning paper, silicone cloth, etc. Dust on the lens or the viewfinder should first be blown off with a blower brush and then wiped lightly with cleaning paper impregnated with cleaning liquid. After the camera has been used on a beach or near the sea, clean it well because salt can affect its mechanisms. A blower brush should also be used to clean the mirror box inside the camera body. If it should require wiping, by all means, please take the camera to a Canon authorized distributor or any qualified and reliable service centre. The film compartment has to be cleaned with a blower because it easily collects film dust. If the dust contains sand, the film is easily scratched. When cleaning the rail surface or the pressure plate, please use cleaning paper and cleaning liquid. Be careful not to touch the shutter curtain when doing so.

Maintenance Keep the camera in a place with low humidity and no dust (**Avoid** storing them in drawer or inside any container that has little ventilation). After removing the camera from the case, take the battery out. When you are going to store the camera for a long time without using it, the shutter release button must be activated now and then, to prevent mold and mechanical trouble. Please **avoid** storing the camera in places such as mentioned below. 1. Inside the trunk or rear window of a car because the temperature can rise to an extremely high degree and this may give rise to trouble in the camera. 2. Places such as laboratories where chemicals are around may cause rust or corrosion.

Note: When taking off the top cover of the soft case, turn the top cover to the bottom then slide the cover straight up and pull it out of the hole as shown in the photo.

When the camera is used in very cold conditions: Battery performance is usually affected by temperatures below zero C. It is always necessary to use a new battery for photography in such extreme cold. Moreover, an extra battery should be taken along and kept warm by placing it next to your body. The battery may not function well at low temperatures but it may well work perfectly under normal conditions, so don't throw it away. In sudden changes of temperature from hot to cold or vice versa, the viewfinder or this lens may get moist and fog. Therefore, the camera should be exposed to the temperature change gradually. At least 30 minutes should be taken for a change of 10 degrees C. The camera has to be kept in a plastic bag completely sealed and then taken out once it has been adjusted to the outside temperature little by little.

Canon AE-1 – Specifications

Type: 35mm SLR (Single-Lens-Reflex) camera with electronically controlled AE (Automatic Exposure) and focal plane shutter.

Picture Size: 24 x 36mm

Interchangeable Lenses: Canon FD series with full aperture metering and AE coupling. Canon FL series with stopped-down metering.

Standard Lenses: Canon FD 55mm f/1.2 S.S.C; Canon FD 50mm f/1.4; S.S.C. Canon FD 50mm f/1.8 S.C. or the New FD 50mm f/1.2, New FD 50mm f/1.4 and the New FD 50mm f/1.8.

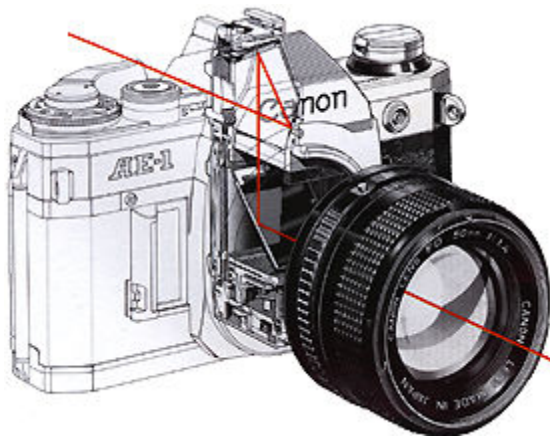

Lens Mount: Canon Breech-Lock mount. Canon FD, FL and R lenses can be used.

Viewfinder: Fixed eye-level pentaprism

Field of View: 93.5% vertical and 96% horizontal coverage of the actual picture area.

Magnification: 1:0.86 at infinity with a standard 50mm lens.

Viewfinder Attachments: Angle Finder A2 and B, Magnifier S, Dioptic Adjustment Lens (10 kinds), and Eyecup S.

Mirror: Instant-return, large reflector mirror with shock absorbing mechanism.

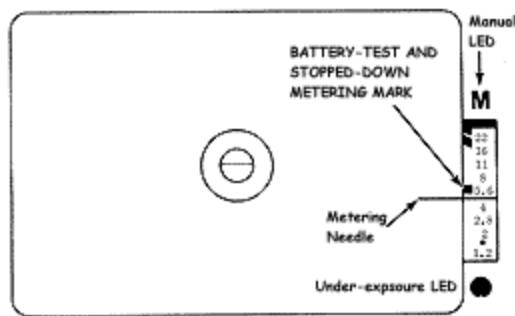

Viewfinder Information:

Split- image/micropism rangefinder, aperture scale with meter needle and stopped-down metering index mark which also serves as battery charge level check mark.

Besides, there are two red zones at the top of the aperture scale to warn of overexposure. Below the aperture scale, a red warning LED lamp blinks to indicate underexposure. This lamp also indicates that the selected shutter speed is outside the AE coupling range with respect to the ASA of the film being used. Above the aperture scale, a manual aperture control "M" signal (red LED) blinks as a warning that the aperture ring is not set at the "A" mark for AE photography.

AE Mechanism: Shutter priority, electronically controlled AE metering system incorporating two ICs and one LSI equipped with μ L(Integrated Injection Logic)

Light Metering System: TTL (Through-the-Lens) Central Emphasis Metering method employing a Silicon Photocell as photosensitive element.

Exposure Meter Coupling Range: With ISO 100 film, EV1 (f/1.4 at one second) to EV18 (f/16 at 1/1000 second).

Film Speed Range: ISO 25 to ISO 3200.

Exposure Correction: By pressing the backlight control switch, exposure is corrected by the automatic opening of the diaphragm 1.5 stops more on the aperture scale than the actual setting.

Exposure Preview: The meter needle will indicate in the viewfinder when the shutter release button is depressed halfway or the exposure preview switch is depressed.

Shutter: Cloth focal plane shutter with four spindles. Shock and noise damping mechanisms are incorporated. All shutter speeds are electronically controlled.

Shutter Speeds: 1 /1000, 1/500, 1/250, 1/125, 1/60, 1/30, 1/15, 1/8, 1/4, 1/2, 1, 2 (seconds) and B. X synchronization is at 1/60 seconds.

Shutter Speed Dial: The shutter speed dial is on the same axis as the film advance lever. The number 2 for two seconds is marked in orange; other numbers as well as X synchronization are in white. There is a shutter dial guard to prevent unintentional movement of the dial. The ISO dial is located underneath the shutter speed dial.

Shutter Release Button: It is a large, button type magnetic release switch. Depressing the shutter release button halfway switches on the light metering circuit, while full depression releases the shutter. The shutter release button has a locking device, besides a socket for the cable release in the center.

Self-Timer: Electronically controlled self timer. After the self-timer lever is pushed forward, the self-timer is activated by the shutter release button. The self-timer releases the shutter after a time lag of 10 seconds. A self-timer lamp (red LED) blinks on and off to indicate when the self-timer is in operation.

Stopping-Down the Lens Stopping-down the lens can be performed by pushing the stopped-down lever after setting the aperture ring.

Power Source: One 6V silver oxide battery Eveready No.544, UCAR No.544 JIS 4G 13, or Mallory PX28) or alkaline manganese battery (Eveready No.537, UCAR No.537, or Mallory 7K13). The battery lasts approximately one year under normal use.

Battery Check: Battery power level can be checked by the meter needle in the viewfinder

when the battery check button is pressed.

Flash Synchronization: X synchronization is at 1/60 second. M synchronization is at 1/30 second and below.

Flash Terminal: The accessory shoe has a direct flash contact and automatic flash control contacts. On the front of the camera body is the flash terminal, JIS-B type for flash units with a cord. It has a built-in protective rim to prevent electrical shock.

Automatic Flash: With the exclusive Canon Speedlite 155A, the shutter speed and aperture are automatically set. The amount of light is automatically controlled for correct flash exposure.

Back Cover: The camera's back cover has a memo holder for your convenience. The cover can be removed for attaching the Canon Data Back A. To open, pull the rewind crank up.

Film Loading: Easy film loading with multislot take-up spool.

Winding Lever: Single stroke with 120° throw and 30° stand-off. The film can be wound with several short strokes. The Canon Power Winder A also can be mounted for automatic winding of the film.

Frame Counter: Additive type. Automatically resets when the back cover is opened. While rewinding film, it counts back the frame numbers.

Film Rewinding: Performed by pressing the rewind button on the bottom and by using the rewind crank on the top. The rewind button is automatically reset when the film is advanced with the film advance lever.

Safety Devices:

* The shutter does not drain battery power when not released.

* The film cannot be wound while the shutter is in operation.

Size: 141 x 87 x 47.5mm (5-9/16" x 3-7/16" x 1-7/8") body only.

Weight: 590g (20-13/16 ozs.) body only. 790g (27-7/8" ozs.) with the 50mm f/1.8 S.C. lens. 895g (31-9/16 ozs.) with the 50mm f/1.4 S.S.C. lens.

AE-1's exposure flow chart

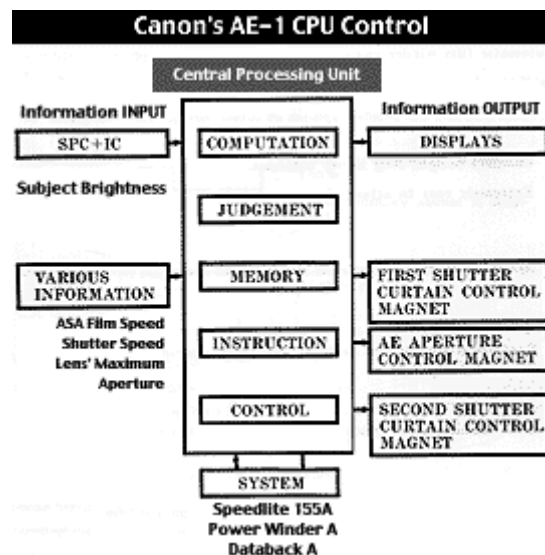

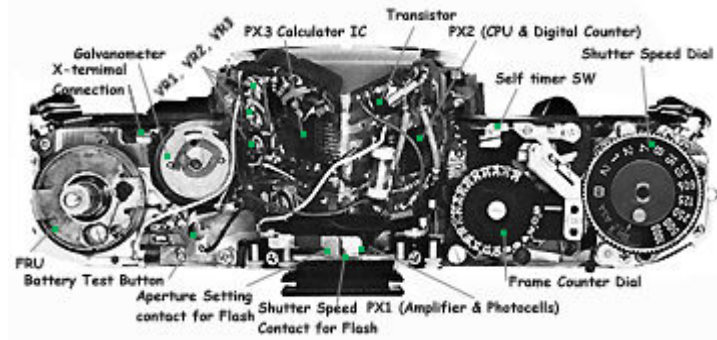

Although looks complicating, but the AE-1 has a very modular construction.

There are five main modules in 1) Viewfinder Unit, 2) Shutter Unit, 3) Mirror Unit, 4) AE Aperture Unit, 5) Automatic Diaphragm Unit

The key advantages of a modular construction are: streamline processing and assembly, improved durability, better precision and most important of all, decreased cost of production. But as earlier days of electronic cameras, most users regarded these as 'unrepairable' components and differ from mechanical bodies which can look for replacement of individual parts. Well, all modern electronic cameras are made this way now, even the most hardcore users have accepted the fact...

The AE-1 was designed from the ground up with five major units and twenty-five minor units. They were centrally controlled by a microcomputer. The major advantage of automation in the camera design and thus followed by manufacturing process is: by incorporating electronics, the parts count in a camera will be greatly reduced as compared with an mechanical camera, the AE-1, in this case, could be reduced by 300. The manufacturing of the camera was also highly automated. This made it possible to produce a low-cost camera having high-end features. The record sales of 5 million units attributed by a combination of variable factors set by the AE-1 will be long remembered and chances of breaking by another model is very slim.

Some technical info:

- You can lock the stop-down lever at the stopped-down position when you're set to a manual f/stop setting (**Note:** It can only be used at manual f stop settings). You can then use the FL lenses with stopped-down metering. Suppose that your diaphragm-setting ring is at "A" and you decide to use the depth-of-field preview. You turn the diaphragm-setting ring to a manual setting and push in the stop-down lever. But before you return the diaphragm-setting ring to the "A" position, set the largest aperture. Otherwise, the camera won't program the aperture automatically.
- The backlight control button automatically opens up 1.5 f stop overexposure as compensation for backlighted subject.
- The self-timer function delays the shutter release for 10 seconds. During the selftimer operation, the self-timer LED flashes on and off twice a second (2 Hz).
- There are two warning LED's visible through the finder. If you're set to a manual f/stop, the LED at the top of the aperture scale flashes on and off as you start depressing the release button. The LED then illuminates the letter "M" for "manual. "

A second LED at the bottom of the aperture scale flashes on and off to warn of underexposure. Both LED's flash at 4 Hz.

- When you push the battery-test button, the needle should move to the battery-test mark or below it. The battery-test mark also provides the stopped-down-metering mark when you're using the FL lenses.

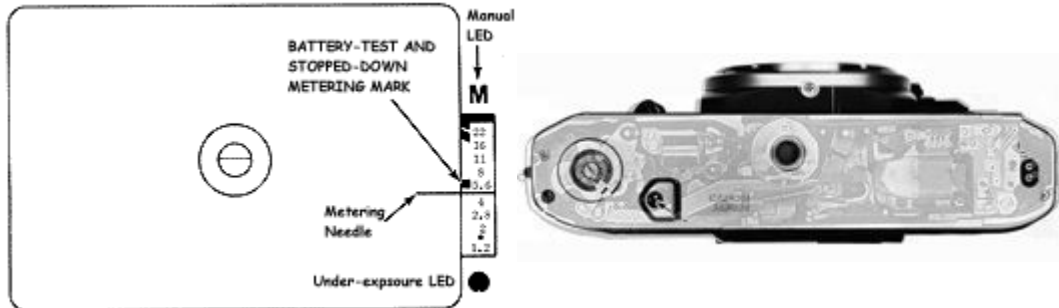

- The front surface of the maximum-aperture correction pin should be 5.7mm (+0, - 0.2mm) from the front surface of the lens-mounting ring. To make the adjustment, first loosen the set screw in the center of the maximum-aperture correction pin. You can then turn the maximum-aperture correction pin clockwise to increase the distance. To decrease the distance, turn the maximum-aperture correction pin counterclockwise and turn in the setscrew to hold the adjustment.

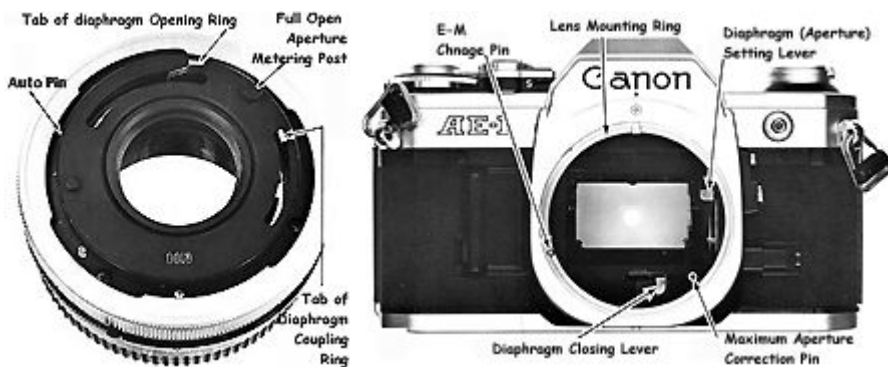

- The flange-focal distance to 41.9mm between the front of the lens-mounting ring and the film-guide rails or to 42.14mm between the lens mounting ring and the pressure-plate rails.

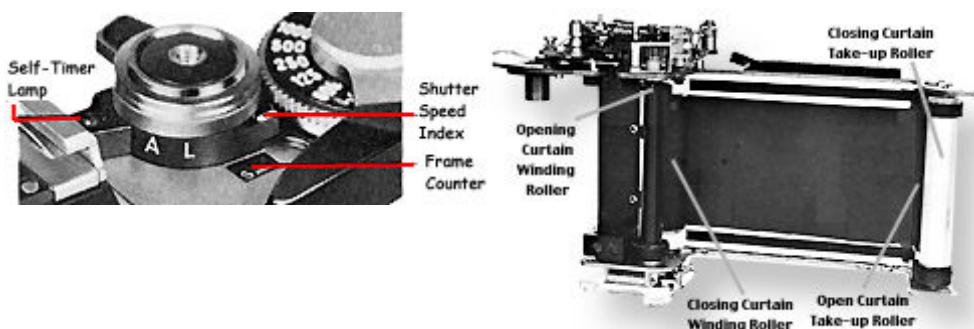

Flash Photography with Canon A-1 There are four groups of flash can be used with Canon SLR camera system. Since Canon only introduced **TTL OTF** (Through-the-Lens, Off-the-Film-Plane) feature very late in 1986 with the **Canon T-90** and a dedicated TTL-flash in **Speedlite 300-TL**, flash photography method was primarily using AE (Automatic Exposure) flash system. Personally, I don't regard flash photography with Canon was their strongest asset, but nevertheless, they did command the best of knowledge with automated flash system since the days of the original Canon F-1's proprietary CAT Flash System introduced way back during 1970. Another group is being flash for macro-photography with MacroLite flash units. The last is to use with older flash bulbs.



Among the three electronic flash groups, the AE flash (Canon has designed their flash with a word 'Speedlite' rather than flash unit, so it is very easy to identify them from flash of other makes) has the most sizes, 'varieties' and power output. There are further sub-divided into shoe mount flash or handle flash which usually has a higher power output (Rated by guide number). The most powerful flash unit within the Canon flash group is a handle flash 577G which has a very high guide number of 48 (ASA 100, m) or 80 (ASA 25, ft.) ! To take full advantage of all the A-1's electronics, Canon has some dedicated flash units. One is the **Speedlite 199A**. Those days, 'dedicated' flash still limiting to auto set the sync speed to pre-set shutter speed or just providing a viewfinder flash ready light. The 199A, in this case, when used with the Canon A-1 will make flash photography completely automatic and electronic, this unit employs an ¹LSI and Canon claimed for first time such advanced circuitry has been used in a flash. Once the 199A is slipped onto the camera's hot shoe (and locked by the convenient locking device), all you have to do is turn it on and set the auto aperture on the flash.



There are three to choose from: f/2.8 f/5.6 and f/11 with ASA 100 film. Corresponding to distances of 1.5 - 10.6m, 1 - 5.3m and 0.5 - 2.6m respectively should provide more than acceptable result under most situations and more importantly, provided your subject is within the distance range selected (apply to any flash units). You can also override the AE flash feature by sliding the Auto/Manual switch to Manual and choose a shutter speed slower than 1/60 sec. to make the background more luminous and in balance with the foreground. Or, you can get bounce flash effects by tilting the 199A's head upward to one of three positions: 60, 75

and 90 . Flash coverage of lenses as wide as 24mm is also possible by attaching the Wide Adapter.



60 F 5.6 Other popular Canon flash units are not quite so powerful but equally as reliable and automatic as the 199A are the Speedlites 188A, 177A, 155A and 133A.

All of these units are like the 199A in that they automatically change the shutter speed to 1/60 sec. and set the camera to the automatic flash aperture you have set. There are two on the 188A, 177A and 155A (f/2.8 and f/5.6, ASA100) and one on the 133A, f/4. Used with the Wide Adapter, the 188A and 177A give flash coverage of 28mm lens field. For flash other than having its contact on the flash feet or if you want to set up multiple flash units, you can use the PC terminal as well.

And since all of these units couple perfectly with the A-1's circuitry, they can be used with the Power Winder A2/A for automatic flash continuous shooting. However, since Canon advises multiple exposures mode in not recommended to work in continuous mode for most of the A series models, I am not so sure whether it applies in the flash AE mode as well for stroboscopic effect.

A series Cameras with Canon Flash Units on Automatic Mode				
Flash models	Canon A-1	Canon AE- Program	Canon AE-1	Canon AV-1 and AL-1
199A, 577G, 533G	Shutter speed and aperture set automatically. Viewfinder shows flash ready. Special procedure allows use of 1/30 to 30-second exposures with automatic features.	Shutter speed and aperture set automatically.	Shutter speed and aperture set automatically.	Shutter speed set automatically. You set aperture.
188A, 166A	Shutter speed and aperture set automatically. Viewfinder shows flash ready.	Shutter speed and aperture set automatically. Viewfinder indicator shows flash ready and correct exposure.	Shutter speed and aperture set automatically.	Shutter speed set automatically. You set aperture.
177A, 155A	Shutter speed and aperture set automatically.	Shutter speed and aperture set automatically.	Shutter speed and aperture set automatically.	Shutter speed set automatically. You set aperture.
133A, 011A	Shutter speed set automatically. Aperture set automatically to f4. If film speed not ASA 80/100 or ASA 400, use manual mode.	Shutter speed set automatically. Aperture set automatically to f4. if film speed not ASA 80/100 or ASA 400, use manual mode.	Shutter speed set automatically. Aperture set automatically to f4. If film speed is not ASA 80/100 or ASA 400, use manual mode.	speed set automatically. You set aperture as appropriate for film speed

Note: Although rarely used today, flash bulbs will work with Canon A-1, AE-1, AE-1 Program etc cameras which are using a horizontal traveled focal plane shutter design. If you are using type FP, MF or M flash bulbs, 1/30 second is the fastest shutter speed you can use. Naturally, with flash bulbs there is no automatic flash operation. Also check sync speed with flash bulbs for models: Canon AE-1, AE-1 Program.

Can the Canon A-1 or for that matter, all the A and T series SLR models interchangeable to use with all the A, G and T series flash units ? With the exception of the T90, all of Canon's A-series and T-series as well as the New F-1, will automatically set their X-sync with any A-series, T-series (except 300TL) and G-series (533G & 577G) of Canon Speedlites. Some has their own respective dedicated function, for an instance, AE-1 Program will automatically reverts to

Program Flash AE the moment the pilot lamp of your Speedlite 244T is ready.



Speedlite 577G

Speedlite 577G

Guide Number: 48 (ASA 100, m) or 80 (ASA 25, ft.).

Recycling Time (on automatic): 0.2-18 sec. with alkaline-manganese batteries. 0.2-7 sec. with Ni-Cd batteries.

Number of Flashes (on automatic): 100-1,000 with alkaline-manganese batteries and 75-750 with Ni-Cd batteries allowing 30 sec. between each firing.

Flash Duration: 1/400-1/50,000 sec.

Auto Apertures: f/2.8, f/5.6 and f/11 at ASA 100,

Auto Coupling Ranges: 2.5-17m at red "A" (f/2.8, ASA 100) without Adaptor. At green "A", 1.5-8.5m and at yellow "A", 1-4.3m without Adaptor.

The most powerful flash among all Canon Speedlites, with a guide number of 48 (ASA 100, m) or 80 (ASA 25, ft.).

Flash Coverage: For 35mm format, covers an angle of view of 35mm lens With Wide Adaptor, adequate coverage for 20mm lens. With Tele Adaptor, covers 100mm lens.

Bounce: Maximum upward tilt of 120° with detents at 0°, 60°, 75°, 90°, and 120°. 120° shift to both left and right with detents at 0°, 60°, 75°, 90°, 105° and 120°.

Power Source: 6 C-size alkaline-manganese batteries or Ni-Cd Pack TP in the Transistor Pack G.

Size: 99 (W) x 107 (D) x 245 (H)mm (2-7/8" x 4-1/4" x 9-5/8").

Weight: 600g (21-3/16 ozs.) without batteries.

Speedlite 533G

Guide Number: 36 (ASA 100, m) or 60 (ASA 25 ft.).

Recycling Time: 0.2-10 sec. with alkaline manganese batteries. 0.2-5.5 sec. with Ni-Cd batteries.

Number of Flashes (on automatic): 120 - 1,200 with alkaline-manganese batteries and 55 - 555 with Ni-Cd batteries allowing 30 sec. between each firing.

Flash Duration: 1/830-1/50,000 sec.

Auto Apertures: f/2.8, f/5.6 and f/11 at ASA 100.

Auto Coupling Ranges: 2.5-12.8m at red "A" (f/2.8, ASA 100) without Adaptor. At green "A", 1.5-6.4m and at yellow "A", 1-3.2m without Adaptor

Flash Coverage: Adequate for 35mm lens on a 35mm format. With Wide Adaptor, adequate coverage for 20mm lens. With Tele Adaptor, covers 100mm lens.

Specifications for some popular shoe mount flash units by Canon

199A 188A 177A 166A 155A 133A 011A

Speedlite 199A Guide Number: 30 (ASA 100, m) or 50 (ASA 25, ft.).

Recycling Time: 0.2-10 sec. with alkaline batteries and 0.2-6 sec. with Ni-Cd batteries on auto.

Number of Flashes: More than 100 with alkaline batteries and more than 50 with Ni-Cd batteries on auto.

Flash Duration: 1/500-1/50000 sec.

Aperture Choices: f/2.8 (red), f/5.6 (green) and f/11 (yellow) at ASA 100, and manual.

Auto Coupling Ranges: 1.5-10.6m (1.5-6.3m with Wide Adaptor) at red "A". 1-5.3m (1-3.2m with Wide Adaptor) at green "A". 0.5-2.6m (0.5-1.6m with Wide Adaptor) at yellow "A".



Flash Coverage: Covers 35mm lens. With Wide Adaptor covers 24mm lens.

Size: 79 (W) x 83 (D) x 116 (H)mm. (3-1/8" x 3-1/4" x 4-1/2").

Weight: 490g (1 lb. 1-5/16 ozs.) including batteries

Speedlite 188A Guide Number: 25 (ASA 100, m) or 41 (ASA 25, ft.).

Recycling Time: 0.5-8 sec with alkaline batteries and 0.5-6 sec. with Ni-Cd batteries on auto.

Number of Flashes: More than 200 with alkaline batteries and more than 70 with Ni-Cd batteries on auto.

Flash Duration: 1/700-1/40000 sec.

Aperture Choices: f2.8 (red) and f5.6 (green) at ASA 100 and manual.

Auto Coupling Ranges: 1.0-9.0m (1.0-5.6m with Wide Adaptor) at red "A". 0.5-4.5m (0.5-2.8m with Wide Adaptor) at green "A".



Flash Coverage: Covers 35mm lens. With Wide Adaptor, covers 28mm lens.

Size: 68 (W) x 52 (D) x 103 (H)mm. (2-11/16" x 2-1/16" x 4-1/16").

Weight: 290g (10-1/4 ozs.) including batteries.

Speedlite 177A Guide Number: 25 (ASA 100, m) or 41 (ASA 25, ft.).

Recycling Time: 0.5-8 sec. with alkaline batteries and 0.5-6 sec. with Ni-Cd batteries on auto.

Number of Flashes: More than 200 with alkaline batteries and more than 70 with Ni-Cd batteries on auto.

Flash Duration: 1/600-1/50000 sec.

Aperture Choices: f/2.8 (red) and f/5.6 (green) at ASA 100, and manual.

Auto Coupling Ranges: 1.0-9.0m (1.0-5.7m with Wide Adaptor) at red "A". 0.5-4.5m (0.5-2.8m with Wide Adaptor) at green "A"



Flash Coverage: Covers 35mm lens. With Wide Adaptor, covers 28mm lens.

Size: 72 (W) x 58 (D) x 107 (H)mm. (2-13/16" x 2-5/16" x 4-3/16").

Weight: 310g (10-15/16 ozs.) including batteries.

Speedlite 166A

Guide Number: 20 (ASA100, m) or 33 (ASA 25, ft)

Recycling Time: 0.5-7 sec. with alkaline batteries and 0.5-5 sec. with Ni-Cd batteries.
Number of Flashes: 250-2500 times with alkaline batteries and 80-830 times with Ni-Cd batteries.

Flash Duration: 1/1000-1/50000 sec

Auto Apertures: f/2.8, f/5.6 at ASA 100.

Auto Coupling Range: 0.5 -7 m (1.6-22 ft.) at ASA 100

Flash Coverage: Covers 35mm lens.



Power Source: Four AA size alkaline or Ni-Cd batteries.

Size: 66 (W) x 49.5 (D) x 98 (H) mm (2-5/8" x 1-15/16" x 3-7/8").

Weight: 260g (9-3/16 ozs.) including batteries.

Speedlite 155A Guide Number: 17 (ASA 100, m) or 28 (ASA 25, ft.).

Recycling Time: 0.5-7 sec. with alkaline batteries and 0.5-5 sec. with Ni-Cd batteries on auto.
Number of Flashes: More than 300 with alkaline batteries and 90 with Ni-Cd batteries on auto.

Flash Duration: 1/1000 - 1/50000 sec.

Aperture Choices: f/2.8 (red) and f/5.6 (green) at ASA 100, and manual.

Auto Coupling Ranges: 0.5-6m at red "A". 0.5-3m at green "A".

Flash Coverage: Covers 35mm lens.



Size: 70 (W) x 51 (D) x 105 (H)mm. (2-3/4" x 2" x 4-1/8").

Weight: 300g (10-9/16 ozs.) including batteries.

Speedlite 133A Guide Number: 16 (ASA 100, m) or 26 (ASA 25, ft.).

Recycling Time: 0.5-9 sec. with alkaline batteries and 0.5-6 sec with Ni-Cd batteries.

Number of Flashes: 100-1000 with alkaline batteries and 60-600 with Ni-Cd batteries.

Flash Duration: 1/700-100000 sec.

ASA Film Speed Switch: Two positions: ASA 80, 100 (green) and ASA 400 (orange).

Auto Coupling Ranges: 1.0 - 8.0m at orange "A". 0.5 - 4.0m at green "A".

Flash Coverage: Covers 35mm lens.



Size: 62 (W) x 37 (D) x 95 (H)mm (2-7/16" x 1-7/16" x 3-3/4")

Weight: 200g (7-1/16 ozs.) including batteries.