



This manual is for reference and historical purposes, all rights reserved.

This page is copyright© by M. Butkus, NJ.

This page may not be sold or distributed without the expressed permission of the producer

I have no connection with any camera company

On-line camera manual library

This is the full text and images from the manual. This may take 3 full minutes for the PDF file to download.

If you find this manual useful, how about a donation of \$3 to: M. Butkus, 29 Lake Ave., High Bridge, NJ 08829-1701 and send your e-mail address so I can thank you. Most other places would charge you \$7.50 for a electronic copy or \$18.00 for a hard to read Xerox copy.

This will allow me to continue to buy new manuals and pay their shipping costs.

It'll make you feel better, won't it?

**If you use Pay Pal or wish to use your credit card,
click on the secure site on my main page.**

Nikkormat



INSTRUCTION MANUAL

NOMENCLATURE

Neck Strap Eyelet

Shutter-Speed Index
Align with the desired shutter speed.

Self-Timer
Trips the shutter in 8 seconds delay.

Shutter-Speed Lever

ASA Film-Speed Scale
Range: 12-1600 ASA.

Tripod Socket

Rewind Button
Press to rewind the film.

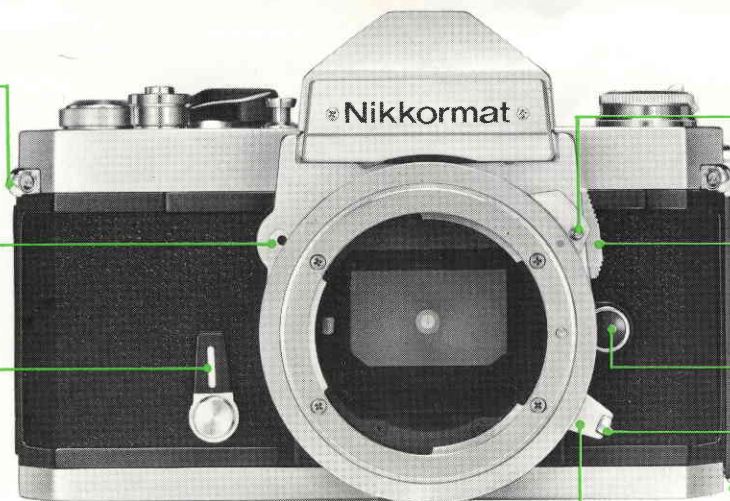

Meter Coupling Pin
Couples the exposure meter to the lens' auto diaphragm.

Mirror Lock
Slide downward to lock the mirror up out of the optical path.

Lens Release Button
Unlocks the lens for removing or changing lenses.

ASA Lock

Camera Back Latch
Press to open the camera back.

ASA Film-Speed Index
Adjusts the meter for the speed of the film used.

Battery Chamber
Houses the silver-oxide battery that powers the meter.

Camera Back
Hinged to swing open from the side.

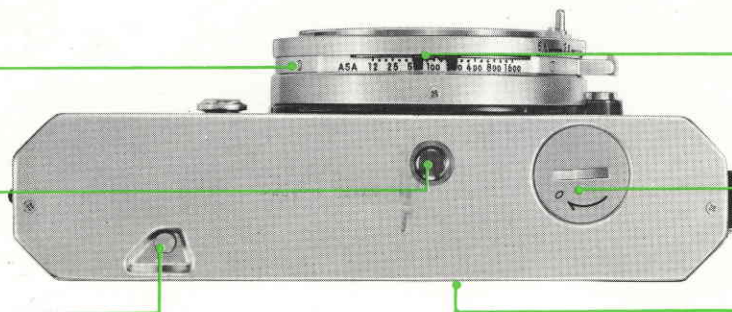

Aperture/Distance Scale Index

Infrared Mark

Lines up with the prefocused distance to compensate for shift in focus.

Aperture Ring

Sets the lens diaphragm to the desired f /number.

Maximum-Aperture Scale

Check to see whether the meter is set for the maximum aperture of the lens being used.

Depth-of-Field Preview Button

Press to preview how much background or foreground is in or out of focus.

Flash Terminal

Accepts a flash synch cord.

Rewind Crank

Fold out to rewind the film.

Meter Window

Accessory Shoe

Finder Eyepiece

Permits comfortable viewing, composing and focusing.

Hot-Shoe Contact

Distance Scale

Depth-of-Field Scale

Color-coded markings give depth-of-field at different apertures.

Focusing Ring

Easy-to-grip, knurled surface for quick, accurate focusing.

Aperture Scale

Meter Coupling Prong

Connects to the meter coupling pin.

Shutter-Speed Scale

Speeds from 1/1000 to 1 second plus B.

Shutter Release Button

(With screw thread for cable release).

Frame Counter

Indicates the number of frames exposed.

Film-Advance Lever

Advances the film, cocks the shutter and operates the frame counter. Also switches the built-in exposure meter on or off.

Film-Plane Indicator

Shows the exact position of the film plane.

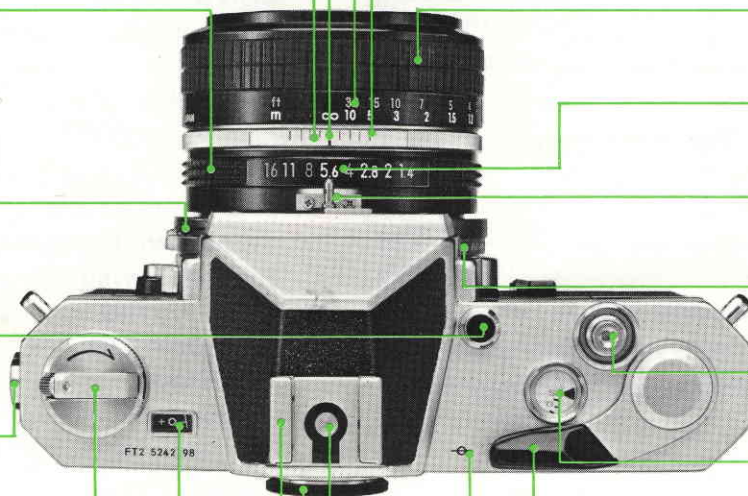

CONTENTS

Nomenclature	2	Depth-of-Field Scale	20
Foreword	5	Changing the Lens	22
Loading the Camera	6	Lens Mounting	22
Film-Plane Indicator	8	Maximum-Aperture Scale	23
Film-Advance Lever	8	Self-Timer	24
Frame Counter	9	Mirror Lock	24
Film-Speed (ASA) Setting	9	Infrared Photography	25
Exposure Controls	10	Silver-Oxide Battery	25
Setting the Shutter Speed	11	Exposure Measurement: Special Cases	26
Setting the Aperture	11	Stop-Down Exposure Measurement	26
Exposure Measurement	12	Repro-Copying	27
Turning On the Meter	12	Slide Copying	27
Centering the Needle	13	Accessories	28
Getting the Right Exposure	14	Lens Hoods	28
How to Hold the Camera	15	Filters	29
Focusing	16	Eyepiece Correction Lenses	29
Shutter Release	17	Finder Eyecup	29
Flash Synchronization	18	Camera Care	30
Depth of Field	19	Features/Specifications	31
Depth-of-Field Preview Button	19	Nikon Warranty	31

FOREWORD

The Nikkormat FT2 offers the high quality performance and durability common to Nikon cameras, but with the basic simplicity of design that has made the Nikkormat camera popular with amateur and professional alike. Systematically-positioned controls for picture-taking ease, a convenient flash unit mount for simplified flash photography and the extensive possibilities of the Nikon System of Photography further enhance the capabilities of the Nikkormat FT2.

To ensure you get the best results from your Nikkormat FT2, read this instruction book carefully and practice using the controls before you load film into the camera. Follow the suggestions on camera care on page 30 and you will receive many years of reliable service. The Nikon Warranty which comes with your Nikkormat FT2 is your assurance of prompt, courteous service and complete satisfaction.

LOADING THE CAMERA

Press down the camera back latch on the side of the camera and the hinged back will spring open. Pull up on the rewind knob and drop a film cartridge into the film chamber with the film leader pointing towards the take-up spool. Now, push down the rewind knob to hold the cartridge in place and insert the end of the film leader into any one of the three slots in the take-up spool. Rotate the take-up spool as shown in the illustration so that the film passes under the spool with its emulsion side (dull side) facing out. Make sure

that the perforations along the edges of the film mesh with the sprockets.

Close the camera by pressing on the back until it snaps into place. Fold out the rewind crank and turn it gently in the direction of the arrow until you can feel a slight tension. This will take up any slack in the film cartridge. Be careful not to exert too much pressure on the rewind crank.

Loading exposes the first few inches of the film. To dispose of this exposed film, wind the film advance

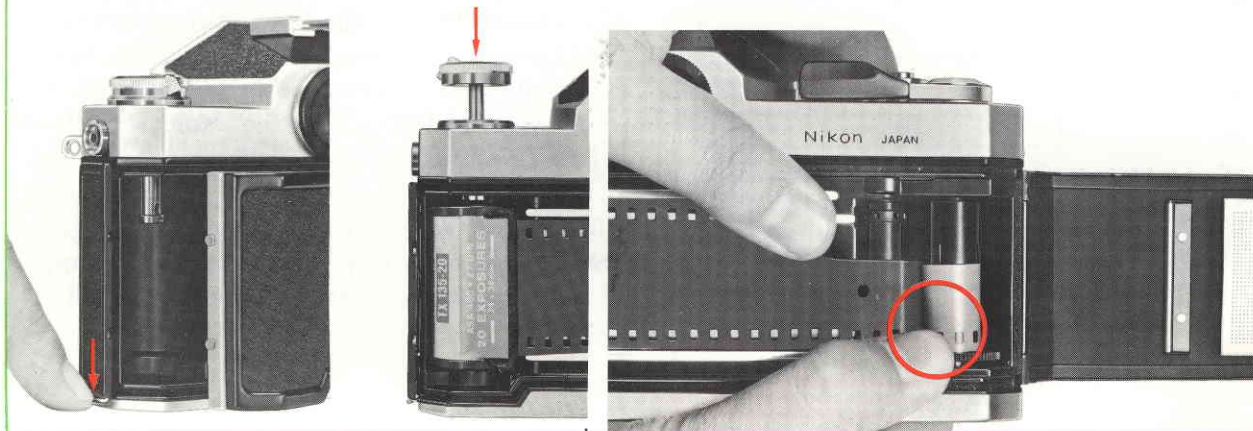

lever and make two blank exposures. Watch the rewind knob to see if it rotates in the direction opposite the arrow while the film is being advanced. This will indicate that the film has been loaded correctly and is being advanced.

The frame counter on top of the camera should now rest at "0". Advance the film one more frame and you are ready to take the first picture.

Caution: Do not load the camera in bright sunlight. If no other shade is available, shade the camera from the sun with your body while loading.

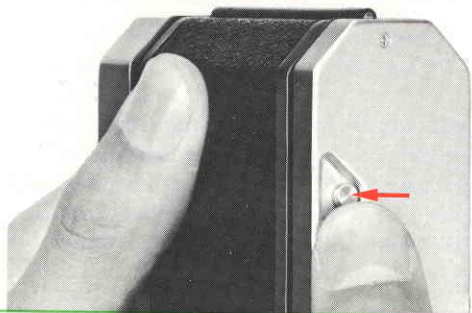

To unload, press the rewind button on the camera baseplate, unfold the rewind crank and turn it with a constant, gentle pressure in the direction of the arrow. Avoid uneven or excessively fast rewinding. When no more tension can be felt and the crank turns loosely, the film has left the sprockets and the camera may be opened. Pull the rewind knob up slightly and the film cartridge will drop out.

The rewind button will pop out again as soon as the film advance lever is stroked.



LOADING THE CAMERA

Film-Plane Indicator



The (⊕) mark on top of the camera body shows the exact position of the film plane. This is important to know when measuring the film-to-subject distance, especially in close-ups and macrophotography.

Film-Advance Lever

The film-advance lever simultaneously advances the film, cocks the shutter and operates the frame counter. It also serves as an on-off switch for the exposure meter.

Stroke the film-advance lever with the right thumb in a single stroke. A built-in locking device prevents the shutter from being released unless it is fully cocked and the film has been advanced a full frame.

The film-advance lever springs back to its original position, with ample clearance for the thumb, after each stroke. However, the meter will remain in the “on” position until the lever is pressed flush against the camera body.

Caution: Be careful not to push the rewind button (on the camera's baseplate) during film advance operation. Should this occur, temporary stoppage of film transport and double exposure of the negative may result.

Frame Counter

The frame counter located on top of the camera works automatically to show how many frames have been exposed. The numbers 20 and 36 are colored red to correspond to the number of frames in a standard 35mm cartridge. The frame counter stops just past the 36-frame mark and resets itself automatically to "S", two frames before "0", when the camera back is opened for reloading.



Film-Speed (ASA) Setting

Some films are more sensitive to light than others. A film's sensitivity is commonly known as its "speed," expressed in ASA numbers.

In order to work with films of different speeds, the Nikkormat FT2's light-meter circuit must be adjusted for the ASA number of the film used. This is done by means of a slotted index pointer located on the bottom of the shutter-speed ring. The ASA film-speed scale has numbered settings for speeds from ASA 12-

1600 with dots between each pair of numbers for intermediate settings such as ASA 64, 80, etc. Pull up the ASA lock on top of the shutter-speed lever and, while holding the lock up, slide the slotted ASA index pointer until it lines up with the ASA number of the film in use. After releasing the ASA lock, check that the ASA index pointer is securely locked into position.

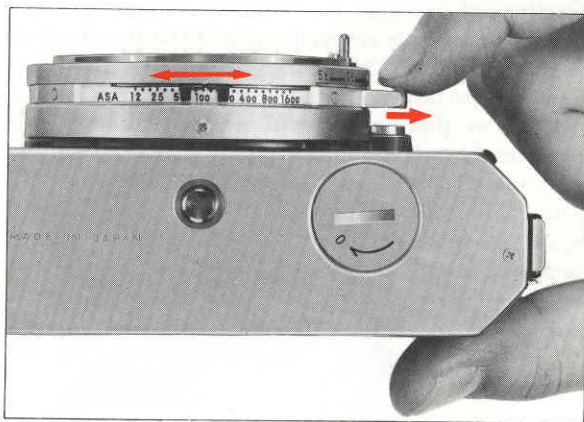

Film-Speed (ASA) Scale

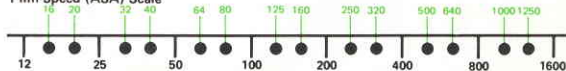

EXPOSURE CONTROLS

The amount of exposure the film receives is determined by a combination of shutter speed and aperture. The larger the lens aperture, the more exposure. Likewise, the slower the shutter speed the greater the exposure. Aperture is expressed in f /numbers with larger numbers representing smaller apertures and vice versa. For example, $f/8$ gives twice as much exposure as $f/11$. Shutter speed is expressed in seconds or fractions of a second. The numbers on the Nikkormat shutter-speed scale are reciprocals of the actual speeds (250 represents $1/250$ second, etc.).

Camera aperture and shutter-speed controls are calculated so that an increase of one f /number compensates for a one-step decrease in shutter speed. For example, $1/250$ at $f/8$ is equivalent to $1/125$ at $f/11$. The table below shows how aperture and shutter-speed are interrelated. All the combinations give the same exposure.

Aperture	$f/1.4$	$f/2$	$f/2.8$	$f/4$	$f/5.6$
Shutter speed (seconds)	$1/500$	$1/250$	$1/125$	$1/60$	$1/30$

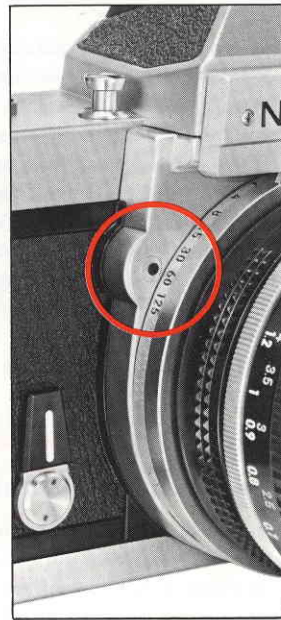
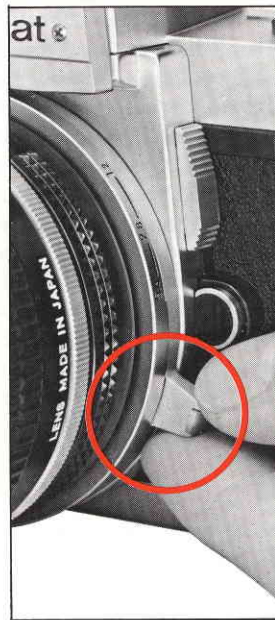

Setting the Shutter Speed

Shutter speeds are controlled by a ring around the base of the bayonet mount rather than the usual dial on top of the camera body. To set the shutter speed, grasp the lever and turn the ring until the desired speed appears next to the indicator dot on the front of the camera body. For added convenience when measuring exposure, the shutter speed in use as well as the next highest and lowest speeds appear in the bottom of the viewfinder, so the shutter speed can be adjusted while observing the exposure meter needle. Click-stopped settings for shutter speeds from 1/1000 to 1 second plus “B” are engraved on the shutter-speed ring. At the “B” (bulb) setting, the shutter remains open as long as the shutter release button is depressed.

Note: Intermediate shutter-speed settings are not recommended except in the 1/250 to 1/1000 second range.

Setting the Aperture

To preset lens aperture, turn the aperture ring on the lens barrel until the desired f/number appears opposite the black indicator line on top of the milled ring; this line also serves as the distance scale index. The aperture diaphragm can be set for intermediate openings between the click-stopped settings for more precise exposure.



EXPOSURE MEASUREMENT

The Nikkormat FT2 features a center-weighted thru-the-lens exposure metering system cross-coupled to the shutter speed and aperture controls. The meter reads the light over the entire focusing screen but favors a central area. This means that correct exposures are possible even in situations where an averaged reading would result in wrong exposure—with strong backlighting, for example.

Full-Aperture Exposure Measurement

The FT2 meter takes advantage of automatic diaphragm feature of Nikkor Auto Lenses to measure light at the maximum aperture of the lens. This insures a bright viewfinder image for viewing and focusing and minimizes the influence of light entering through the finder eyepiece.

In order for the FT2 meter to measure exposure at full aperture with lenses of different maximum aperture, it must be coupled with the maximum aperture of the lens in use. This is done each time the lens is attached or changed by turning the aperture ring of the lens through its entire range (see “Changing the Lens,” p.22.).

Turning On the Meter

To switch on the Nikkormat FT2's CdS exposure metering circuit, pull out the film advance lever just enough to uncover the red dot on top of the camera body. When the meter is not in use, press the lever flush against the camera body, since the battery is being drained continuously as long as the lever is in the “on” position.

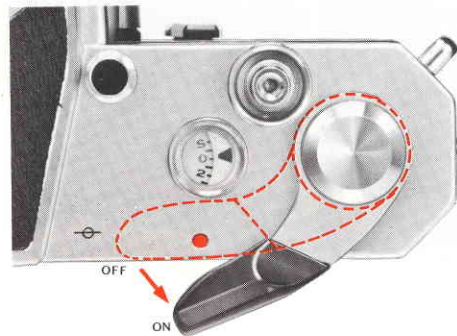

A number of different shutter speed-aperture combinations will usually result in the same exposure. The “best” one depends on the results desired. Use fast shutter speeds to “freeze” motion or slow ones to create deliberate blur. Small apertures give greater depth of field, large ones let the subject stand out against an out-of-focus background (see “Depth of Field,” p.19.).

Centering the Needle

To determine correct exposure, adjust the aperture and/or shutter speed until the meter needle in the viewfinder is centered (the - and + marks let you know whether you are under- or overexposing). A second meter needle is conveniently located on top of the camera for use with the camera held at waist-level or mounted on a tripod. For fine adjustments of less than one f/number, use the aperture ring as it permits reliable intermediate settings.

Under extremely low light conditions the meter needle may center at the “B” setting on the shutter speed dial. If so, correct exposure time is 2 seconds. If the needle moves erratically or cannot be centered even after all possible aperture-shutter speed combinations have been tried, then the light is too bright or dim for the meter’s range. Effective range (coupl-

ing range) varies according to the lens and film speed used. For example, with the 50mm f/1.4 lens and a film speed of ASA 100, it extends from f/1.4 at 1/4 second to f/11 at 1/1000 second.

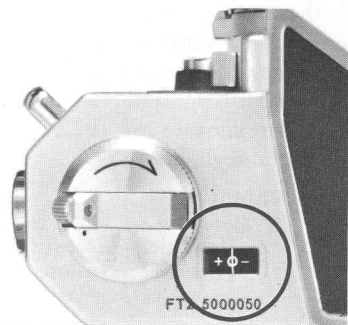
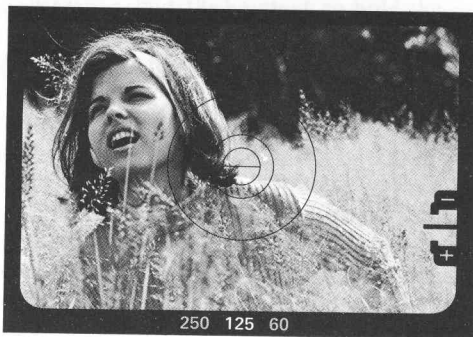

EXPOSURE MEASUREMENT

Getting the Right Exposure

The central part of the focusing screen should always be aimed at the main subject when centering the needle. Otherwise unimportant bright or dark areas may give an exposure reading which is too high or too low, resulting in under- or overexposure.

If an off-center composition is desired, first measure the light striking the main subject and set the aperture and shutter speed to center the needle. Then move the camera until the desired composition appears in the viewfinder.

For subjects of uniform tonal brightness, a reading may be taken from any part of the subject. However, if the subject is contrasty (sidelighted portraits, for example), measure the light falling on the most important part of the subject in which detail is desired in the final picture.

For landscapes including large areas of sky, tilt the camera downward during measurement or fill the center of the finder with the main subject to prevent underexposure of the main subject caused by the bright skylight.

Photos:

1. Measuring the bright area in the center of the screen will cause underexposure of the main subject.
2. For correct exposure, first measure the light striking the main subject, then compose and shoot.



Exposure measurement area

Picture area



HOW TO HOLD THE CAMERA



Steady camera holding is important for best results, since even the slightest camera movement at the moment of exposure can result in an appreciable loss of sharpness, especially at slow shutter speeds. The photographs show the best way to hold the camera for rock-steady picture-taking.

Wrap the fingers of the right hand around the camera body so that the index finger rests comfortably on the shutter release button and the thumb fits between the body and film advance lever. This way you can stroke the film-advance without removing your eye from the viewfinder. Cradle the camera in the left hand for additional support, with the left thumb and index finger grasping the focusing ring. The camera may be switched from horizontal to vertical format in this position.

FOCUSING

Focusing is always done at full aperture with Auto Nikkor lenses. This gives the brightest possible image on the focusing screen for easy viewing and composing. It also minimizes depth of field so the image snaps in and out of focus distinctly.

The Nikkormat FT2 focusing screen consists of a matte Fresnel field with a central 3mm ϕ split-image rangefinder spot surrounded by a doughnut-shaped 1mm-wide microprism for rapid, accurate focusing. Look through the viewfinder and turn the focusing ring until the two halves of the central rangefinder image coincide to form a single, sharp image, or until the image in the microprism appears sharp and crisp. This focusing screen is suitable for subjects with both straight lines and ill-defined contours. However, when used with lenses having a maximum aperture smaller than $f/4.5$, or in close-up photography, the rangefinder spot is likely to darken. In this case, focus on the surrounding matte field.

The lens can also be prefocused using the distance scale engraved in both feet and meters on the lens barrel. Line up the black indicator line on top of the milled ring opposite the camera-to-subject distance as measured or estimated. This technique is useful for candid shots of elusive subjects when time does not permit through-the-lens focusing.

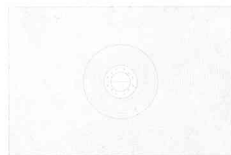

Microprism/split-image screen



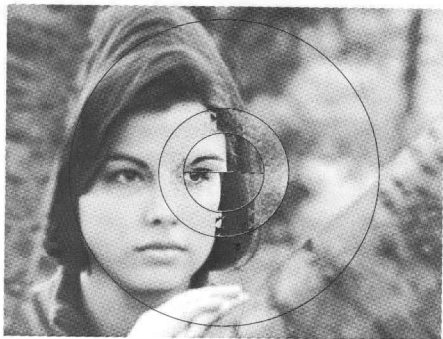

Out of focus

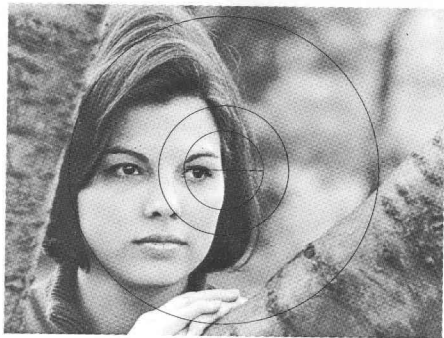

In focus

Shutter Release

For sharp pictures, correct shutter releasing is just as important as steady camera holding. A quick, jabbing movement of the finger on the shutter release button will result in camera movement and blurred pictures. Hold the camera steady as shown previously, relax and squeeze the shutter release with a gentle, even pressure. For long time exposures with the camera mounted on a tripod, use a cable release. The shutter release button is threaded to accept the Nikon F and Nikkormat cable releases. For hand-held exposures at speeds slower than 1/30 second, greater sharpness can be obtained if the shutter release is tripped by means of the self-timer. Set the self-timer mechanism in motion (see "Self-timer," p.24.), hold the camera steady and wait for the timer to trip the shutter.

Caution: When mounting the camera on a tripod, do not over-screw the tripod thread into the camera tripod socket as it may damage the camera baseplate.

FLASH SYNCHRONIZATION

The Nikkormat FT2 features an accessory shoe with built-in hot-shoe contact and automatic MX switch-over via shutter speed selection to facilitate the use of various light sources. Consult the table below to find out which shutter speeds are acceptable for different types of flashbulbs.

Flashbulb	Shutter Speed	1000	500	250	125	60	30	15	8	4	2	1	B
M													
FP													
MF													
X													

■ Synchronized ■ Cannot be used

Either a bulb- or electronic-type flash unit slides over the accessory shoe on top of the pentaprism housing. Due to the built-in hot-shoe contact, the need for a synch cord is eliminated for units with a hot shoe. For units without a hot shoe, use a synch cord and connect the threaded synch terminal on the camera body to the synch socket on the flash unit. To prevent accidental electrical shock, the safety switch in the accessory shoe turns on only when the flash unit is in place.

Nikon speedlight units SB-3 and SB-4 can be directly attached to the Nikkormat FT2. For mounting the Nikon speedlight unit SB-2 or flash unit BC-7, use of the flash unit coupler AS-2 is necessary. For details, refer to the instruction manual provided with each unit.

Note: Nikon speedlight units SB-2, SB-3 and SB-4 are not available in North America.

Caution: Flash units without a hot shoe may fire accidentally when being slipped into place or when a flashbulb is inserted. Although not recommended, accidental firing may be prevented by covering the hot-shoe contact on the camera body with electrical tape.



DEPTH OF FIELD

Depth of field refers to a zone extending in front of and behind the plane of sharpest focus. Within this zone blur (or unsharpness of the image) will be negligible and everything can be accepted as in sharp focus. Depth of field extends a greater distance behind the subject in focus than in front. Depth of field depends on three factors: focal length of the lens, lens-to-subject distance and taking aperture. The smaller the aperture and the shorter the focal length of the lens, the greater the depth of field (for example, wideangle lenses have more depth of field than telephotos). Also, the closer the subject, the smaller the depth of field. These three factors can be adjusted independently or in combination to give the photographer creative control over the final picture.

Depth-of-Field Preview Button

The depth-of-field preview button located on top of the Nikkormat lets you check depth of field before shooting and make desired adjustments. Press the button and the lens stops down to the preselected aperture to allow you to see how much background or foreground is in or out of focus.



Depth-of-Field Scale

Depth of field can be read from the color-coded scale engraved on the milled ring. The pairs of colored lines correspond to f /numbers of the same color. To find the depth of field at a particular aperture first focus the lens on the subject (or set the lens-to-subject distance on the distance scale). Then check the numbers on the distance scale opposite the colored lines which match the taking aperture of the corresponding color to find the depth of field at that aperture.

For example, $f/16$ on the aperture ring of the 50mm $f/1.4$ lens is blue. With the lens prefocused at 15 feet (4.5m), the numbers on the distance scale opposite the blue lines show that depth of field extends from 8 feet (2.4m) to infinity (∞).

By stopping down the lens only, the depth of field can be increased, as illustrated by the following three photographs:

1. Lens at $f/4$. Small depth of field with only main subject in focus.

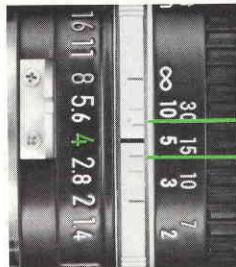

2. Lens further stopped down to $f/8$. Larger depth of field.

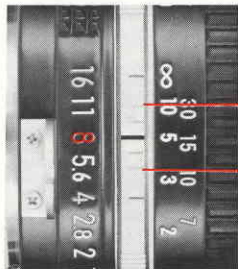

3. Lens at smallest aperture. Great depth of field with subject, background and foreground in focus.

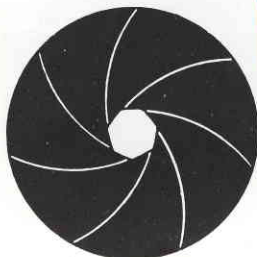
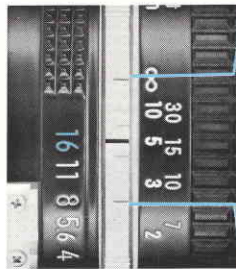

CHANGING THE LENS

To remove the lens from the camera, press the lens release button on the front of the camera body and twist the lens to the right as far as it will go. The lens will come loose and can be lifted out easily.

Lens Mounting

In order for the Nikkormat FT2 exposure meter to measure light at full aperture with lenses of different maximum aperture, the meter must be adjusted for the maximum aperture of the lens in use. This is done each time a lens is mounted as follows:

First push the camera's coupling pin to the right as far as it will go. Set the lens aperture diaphragm at $f/5.6$ and insert the lens into the bayonet mount, making sure that the coupling pin fits into the slotted prong on the lens aperture ring. Twist the lens counter-clockwise until it locks in place with a sharp click. Now turn the aperture ring all the way to the minimum aperture setting (largest f /number), then all the way in the opposite direction. This step automatically adjusts the meter to the maximum aperture of the lens.



Maximum-Aperture Scale

The above adjustment can be confirmed by looking at the maximum-aperture scale on ring with the coupling pin. The scale has a range from $f/1.2$ to $f/5.6$. For example, if the 28mm $f/2.8$ lens is mounted on the camera, the red index mark should fall opposite 2.8.



SELF-TIMER

The built-in self-timer can be used to trip the shutter in approximately eight seconds delay. To cock the self-timer, turn the lever downward as far as it will go. When the shutter release button is pressed, the timer starts. The self-timer is independent of the shutter mechanism and can be set before or after the shutter is wound. Do not use at "B" setting.

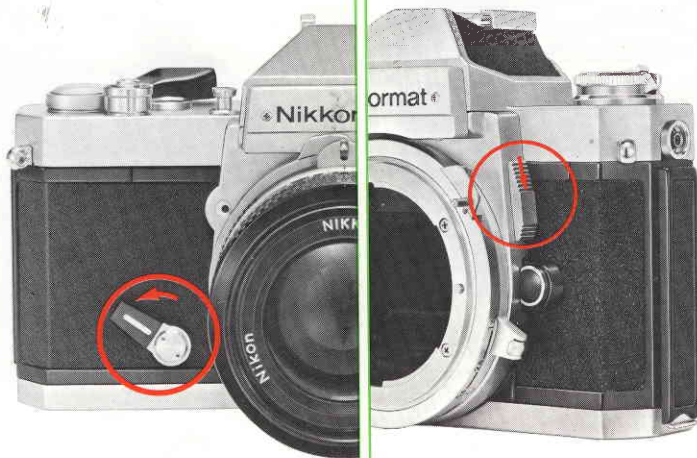

MIRROR LOCK

The reflex mirror can be locked in the "up" position out of the optical path for use with the Fisheye-Nikkor 6mm f/5.6 and the OP Fisheye-Nikkor 10mm f/5.6, whose rear elements protrude into the camera body and interfere with the movement of the mirror. Simply slide the mirror lock downward and the mirror will remain locked up. To return the mirror to its original focusing and viewing position, slide the lever up again.

INFRARED PHOTOGRAPHY

In infrared photography, the plane of sharpest focus is slightly more distant than the one produced by visible light and seen by the naked eye through the viewfinder. To compensate for the shift in focus, Nikkor lenses have a red dot or line on the lens barrel near the color-coded depth-of-field index scale on top of the lens. After focusing the image sharply through the viewfinder, turn the focusing ring to the left until the red dot lines up with the prefocused distance.

For example, in the picture below the 50mm f/1.4 lens has been focused at infinity (∞). The focusing ring is turned slightly to the left so that the infinity mark appears in line with the red dot. When lenses having a focal length of 50mm or less are stopped down to f/8 or smaller, no adjustment is necessary: at such small apertures and short focal lengths, lenses have enough depth of field to compensate for the shift in focus.



SILVER-OXIDE BATTERY

The Nikkormat FT2's meter circuit is powered by a single 1.5-volt silver-oxide battery located in the battery chamber on the camera baseplate. When the battery is exhausted, the meter will cease to function all at once. To replace the battery, unscrew the cap over the battery chamber with a coin or similar object. When installing a new battery make sure that the plus (+) side faces out.

Note: If the meter is exposed to bright light at below-freezing temperatures over a long period of time, it may malfunction or cease to operate until the temperature rises again. Therefore, be careful not to leave the meter on for more than three minutes at a time in cold weather.

Caution: Never throw discarded batteries into a fire.

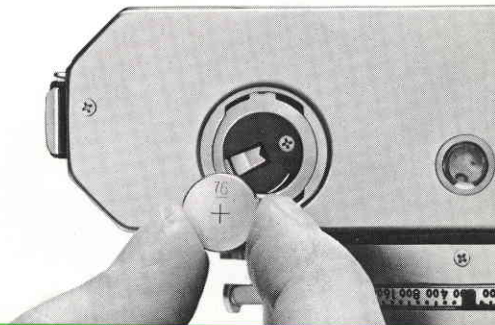

EXPOSURE MEASUREMENT: SPECIAL CASES

Stop-Down Exposure Measurement

With the following lenses and accessories, full-aperture exposure measurement is not possible, either because the lens has no auto-diaphragm or because the diaphragm will not couple with the meter. Therefore, the stop-down method must be used. This means measuring exposure with the lens aperture diaphragm stopped down to the taking aperture.

Push the camera's coupling pin as far to the right as it will go and mount a lens or a lens-and-intermediate unit to the camera in the same way as the Nikkor Auto lenses. Switch on the meter in the usual way.

Bellows Focusing Attachments, Extension Rings and Focusing Unit: To determine exposure, select the desired shutter speed and stop down the lens manually until the needle centers.

Preset Lenses: Use the same procedure as above for lenses having preset diaphragms, such as the PC-Nikkor 35mm f/2.8.

Auto Lenses Without Coupling Prong: Some lenses like the Zoom-Nikkor Auto 200-600mm f/9.5 have an auto diaphragm but no coupling prong. Use the depth-of-field preview button to stop down the lens until the needle is centered.

Reflex-Nikkor Lenses: The Reflex-Nikkor 500mm f/8, 1000mm f/11 and 2000mm f/11 lenses have no aperture diaphragm. Adjust the shutter speed until the needle is centered.

Note: Since focusing may be difficult or impossible at small apertures due to image darkening on the screen, first open the lens to full aperture to focus. Then determine the correct exposure by the stop-down method.



Repro-Copying

For originals such as photographs which have tonal gradation, exposure is determined in the usual way. In the case of originals having strong contrast and no gradation, such as documents or line drawings, measure brightness of the white portion of the original (if the original is predominantly black, a sheet of white paper may be substituted) after decreasing film speed by four marks. Or increase exposure about 1-1/3 stops.

Slide Copying

For originals with continuous tone gradations, determine exposure in the usual way by the stop-down method. To copy slides with letters or figures on transparent background, decrease film speed four marks or increase exposure about 1-1/3 stops. In the case of transparent figures or letters on a dark background, either increase film speed five marks or decrease exposure about 1-2/3 stops.

Important: The above are only approximate guidelines. Exact exposure determination is extremely difficult, especially with color reversal films. Therefore, it is advisable to make several different exposures for each subject to be sure of getting one that is correct.

ACCESSORIES

Lens Hoods

The use of a lens hood is recommended at all times to prevent extraneous light from striking the lens surface and causing flare or ghost, and as an added measure of protection against damage to the lens. Nikon lens hoods come in four types, depending on the lens: Screw-In, Snap-On, Slip-On and Built-In. They are calculated precisely for each focal-length Nikkor lens to provide maximum protection against stray light. To attach or remove the snap-on hood, first depress the spring latch—which is marked with an arrow—and slide it in the direction of the arrow. The hood will also fit directly over a screw-in filter, so both can be used on a lens at the same time. When not in use, the



snap-on hood can be reversed for storage on the lens, and the lens and its hood can be stored together in the eveready case.

Filters

Nikon filters are made of optical glass, ground and polished so that both surfaces are optically flat and parallel.

Nikkor lenses and Nikon filters are made for each other. For best results, use Nikon filters on Nikkor lenses. The filters are available in both screw-in and series mounts, depending on the lens.



Except for the R60, no Nikon filter requires exposure compensation when used with the Nikkormat FT2. When using the R60 filter under tungsten light, increase the exposure by one f-stop more than indicated by the exposure meter.

Note: If you wish to leave a filter on the lens to protect it against accidental damage, the use of the L37 or L37C filter is recommended.

If the lens is pointed toward the sun or toward a very bright light at night, it is best to remove any filter, since light reflected from the filter surface may form ghost images on the film.

Eyepiece Correction Lenses

The nine eyepiece correction lenses are designed to permit nearsighted or farsighted users to view and focus without their glasses. Available in -2 , -3 , -4 , -5 , 0 , $+0.5$, $+1$, $+2$ and $+3$ diopters, each representing the combined dioptery of the lens and the finder. Simply unscrew the finder eyepiece and then screw on the right correction lens.



Finder Eyecup

The soft rubber finder eyecup fits directly onto the finder eyepiece to prevent extraneous light from entering the viewfinder.



CAMERA CARE

Good camera care is primarily common sense care. Treat your Nikkormat as you would any valuable precision instrument and it will last a lifetime.

Although the Nikkormat is ruggedly constructed to withstand rough handling, it may be damaged by shock, heat, water or misuse. The following are some basic tips for keeping your camera in top condition.

Camera Body

Brush the inside of the camera periodically using a soft brush. Do not exert pressure on the shutter curtain as this may damage it.

Keep the mirror free from fingerprints and dust.

Lens

Keep the lens surface free from fingerprints and dust as far as possible.

Use lens tissue to remove dust, never use cloth or ordinary tissue.

If smudges or fingerprints appear, clean them with lens tissue moistened sparingly with alcohol.

Remember, even an approved lens cleaner can cause damage if it seeps into the lens mount.

Storage

Keep the camera in an eveready case or compartment case when not in use to protect it from dust.

Avoid storing the camera in excessively hot, cold or damp places.

Always attach a body cap when the camera body is stored separately.

Do not leave film in the camera for a long period of time.

Never leave the shutter or self-timer cocked if the camera is to be stored overnight or longer.

Keep the camera away from water.

Avoid excessive moisture. When using the camera near water, guard against splashes, especially salt-water spray.

Never oil any part of the camera. Lubrication should be left to an authorized serviceman.

Prior to taking a holiday trip or being assigned an important photo job, test your camera by making a few trial exposures. Remember, it takes at least two or three weeks for processing the test film and making any needed repairs or adjustment. Follow this important precaution and you will have pictures to remember.

NIKKORMAT FT2 FEATURES/SPECIFICATIONS

Type: 35mm single-lens reflex camera

Picture format: 24mm x 36mm (35mm format)

Lens mount: Nikon F bayonet mount

Lens: Nikkor 50mm f/2, 50mm f/1.4 or 55mm f/1.2 as standard. More than 45 Nikkor interchangeable lenses are available.

Shutter: Metal focal-plane shutter with vertical (downward) movement; speeds from 1 to 1/1000 sec., plus B.

Synchronization: Automatic MX switchover with shutter speed setting. Hot-shoe contact with safety switch and threaded synch terminal.

Range of synch: M, FP — 1/1000 ~ 1/250 sec., 1/30 ~ 1 sec.
and B

MF — 1/30 ~ 1 sec. and B

X — 1/125 ~ 1 sec. and B

Viewfinder: Fixed eye-level pentaprism; focusing screen consists of matte Fresnel field with central microprism/split-image rangefinder (K-type).

Reflex mirror: Instant return mirror; independent mirror lock-up control.

Exposure meter: Through-the-lens CdS meter, center-weighted at full aperture. Powered by a single 1.5V silver-oxide battery.

Needle visible in finder and atop the body; plus and minus markings provided. Couples with both diaphragm and shutter speed dial. Metering range: EV3 ~ EV17 (e.g., f/1.4, 1/4 sec. ~ f/11, 1/1000 sec. at ASA 100 with 50mm f/1.4 lens); ASA range 12 ~ 1600; maximum aperture range f/1.2 ~ f/5.6; aperture coupling range f/1.2 ~ f/32.

Film-advance lever: Single-stroke winding lever with 20° stand-off angle and 135° winding angle. Lever also serves as meter on-off switch.

Frame counter: Additive type with automatic reset to "S"; two frames before "0".

Rewinding: Crank type.

Depth-of-field preview: Preview button provided.

Weight: 780g (without lens)

Dimensions: 148mm x 96mm x 54mm

THE NIKON WARRANTY

The Nikon Worldwide Service Warranty Registration Card which identifies your camera by its serial number is your guarantee that the Nikkormat camera you buy is a new one. When you return this card to a Nikon distributor you will receive your Nikon Worldwide Service Warranty Certificate, which entitles you to a one-year warranty anywhere throughout the world, subject to the conditions listed in the certificate.

Only an authorized Nikon dealer can provide you with a Nikon Warranty Registration Card. We cannot guarantee any camera or lens sold to you by an unauthorized dealer without a Warranty Registration Card, since it may be second-hand equipment.