

AKAI SERVICE MANUAL

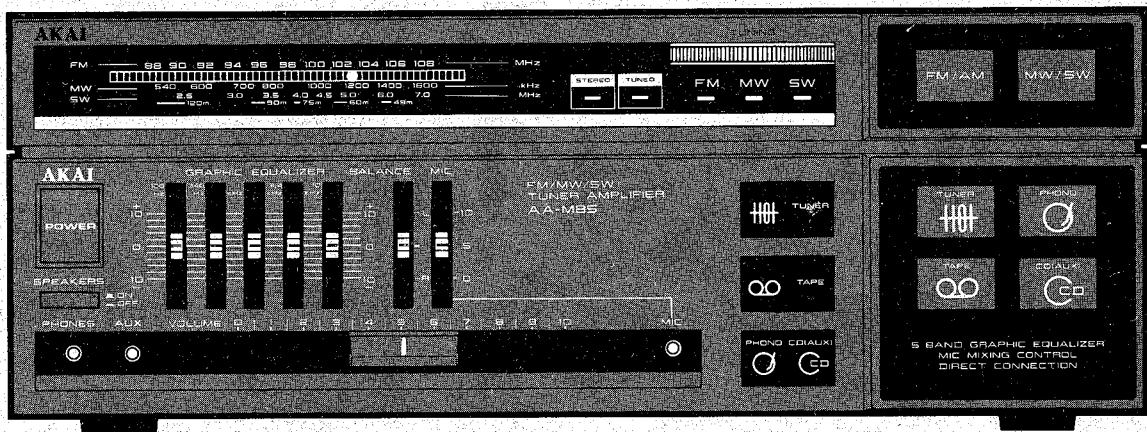

TUNER AMPLIFIER

MODEL **AA-M8S/L**



TUNER AMPLIFIER
MODEL AA-M8S/L

SECTION 1 SERVICE MANUAL	3
SECTION 2 PARTS LIST	13

SAFETY INSTRUCTIONS

SAFETY CHECK AFTER SERVICING

Confirm the specified insulation resistance between power cord plug prongs and externally exposed parts of the set is greater than 10 Mohms, but for equipment with external antenna terminals (tuner, receiver, etc.) and is intended for **C** or **A**, specified insulation resistance should be more than 2.2 Mohms (ground terminals, microphone jacks, headphone jacks, line-in-out jacks etc.)

PRECAUTIONS DURING SERVICING

1. Parts identified by the Δ symbol parts are critical for safety.
Replace only with parts number specified.
2. In addition to safety, other parts and assemblies are specified for conformance with such regulations as those applying to spurious radiation. These must also be replaced only with specified replacements.
Examples: RF converters, tuner units, antenna selector switches, RF cables, noise blocking capacitors, noise blocking filters, etc.
3. Use specified internal wiring. Note especially:
 - 1) Wires covered with PVC tubing
 - 2) Double insulated wires
 - 3) High voltage leads
4. Use specified insulating materials for hazardous live parts. Note especially:
 - 1) Insulation Tape
 - 2) PVC tubing
 - 3) Spacers (Insulating Barriers)
 - 4) Insulation sheets for transistors
 - 5) Plastic screws for fixing microswitch (especially in turntable)
5. When replacing AC primary side components (transformers, power cords, noise blocking capacitors, etc.), wrap ends of wires securely about the terminals before soldering.

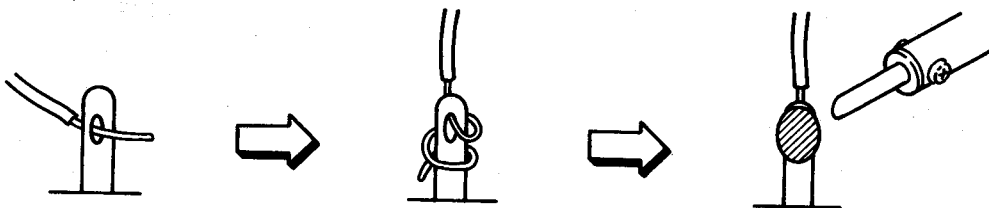

6. Observe that wires do not contact heat producing parts (heatsinks, oxide metal film resistors, fusible resistors, etc.).
7. Check that replaced wires do not contact sharp edged or pointed parts.
8. Also check areas surrounding repaired locations.
9. Use care that foreign objects (screws, solder droplets, etc.) do not remain inside the set.

VOLTAGE CONVERSION

Models for some countries are not equipped with this facility, each machine is preset at the factory according to destination, but some machine can be set to 110V, 120V, 220V or 240V as required.

If the machine's voltage can be converted.

Before connecting the AC power cord, turn the VOLTAGE SELECTOR located on the rear panel with a screwdriver until correct voltage is indicated.

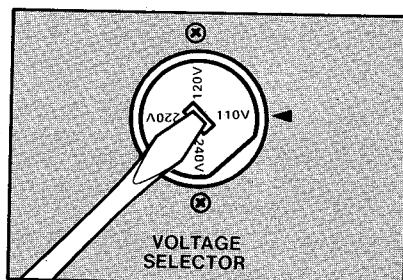

SECTION 1

SERVICE MANUAL

TABLE OF CONTENTS

I. SPECIFICATIONS	4
II. DISMANTLING OF UNIT	5
III. CONTROLS	6
IV. PRINCIPAL PARTS LOCATION	7
V. DIAL CORD THREADING	8
VI. ADJUSTMENTS	9
1. INSTRUMENT CONNECTIONS	9
2. TUNER PC BOARD ADJUSTMENT POINTS	10
3. AM (MW, SW & LW) SECTION ADJUSTMENTS	11
4. FM SECTION ADJUSTMENTS	12
VII. PC BOARD TITLE AND IDENTIFICATION NUMBERS	12

For basic adjustments, measuring methods, and operating principles, refer to GENERAL TECHNICAL MANUAL.

I. SPECIFICATIONS

AMPLIFIER SECTION

FTC OUTPUT POWER

40Hz to 20,000Hz	30W + 30W (0.7% T.H.D., 8 ohms)
RATED POWER OUTPUT	
40Hz to 20,000Hz	25W + 25W (0.3% T.H.D., 8 ohms)
1,000Hz	27W + 27W (0.3% T.H.D., 8 ohms)
FREQUENCY RESPONSE (AUX)	4Hz to 35kHz + 0dB, -3dB
PHONO EQUALIZER DEVIATION	±1dB (20Hz to 20,000Hz)
EQUALIZER	±10dB (100Hz 340Hz, 1kHz, 3.4kHz, 10kHz)
SIGNAL TO NOISE RATIO (IHF-A)	
PHONO	72dB
AUX	90dB
MIC	70dB
RESIDUAL NOISE (IHF-A)	0.5mV
INPUT SENSITIVITY/IMPEDANCE	
PHONO	2.5mV/47 kohms
AUX/CD	220mV/22kohms
MIC	3.0mV/35 kohms

FM TUNER SECTION

TUNING FREQUENCY RANGE	87.5MHz to 108.5MHz
USABLE SENSITIVITY	21dBf
S/N (IHF-A)	70dB (Mono)/55dB (Stereo)
SELECTIVITY	60dB
IMAGE REJECTION RATIO	30dB
IF REJECTION RATIO	90dB
CAPTURE RATIO	1.5dB
STEREO SEPARATION	35dB (1kHz)
ANTENNA TERMINAL	75 ohms coaxial

MW TUNER SECTION

TUNING FREQUENCY RANGE	522kHz to 1,611kHz
USABLE SENSITIVITY (IHF)	300µV/m
SELECTIVITY (IHF)	35dB
IMAGE REJECTION RATIO	38dB
IF REJECTION RATIO	50dB
S/N	45dB

SW and LW TUNER SECTION

	Model AA-M8S	Model AA-M8L
TUNING FREQUENCY RANGE	2.2MHz to 7.3MHz	142kHz to 365kHz
USABLE SENSITIVITY	180µV/m	1000µV/m
SELECTIVITY (IHF)	35dB	35dB
IMAGE REJECTION	30dB	45dB
IF REJECTION RATIO	50dB	50dB
S/N	45dB	35dB
ANTENNA	300 ohms	
POWER REQUIREMENTS	120V, 60Hz for USA & Canada 220V, 50Hz for Europe except UK 240V, 50Hz for UK & Australia 110V/120V/220V/240V, 50Hz/60Hz convertible for other countries	
DIMENSIONS	350(W) × 127(H) × 260(D) mm (13.8 × 5.0 × 10.2 inches)	
WEIGHT	5.0kg (11.0 lbs)	

* For improvement purposes, specifications and design are subject to change without notice.

II. DISMANTLING OF UNIT

In case of trouble, etc. necessitating dismantling, please dismantle in the order shown in the photographs. Reassemble in reverse order.

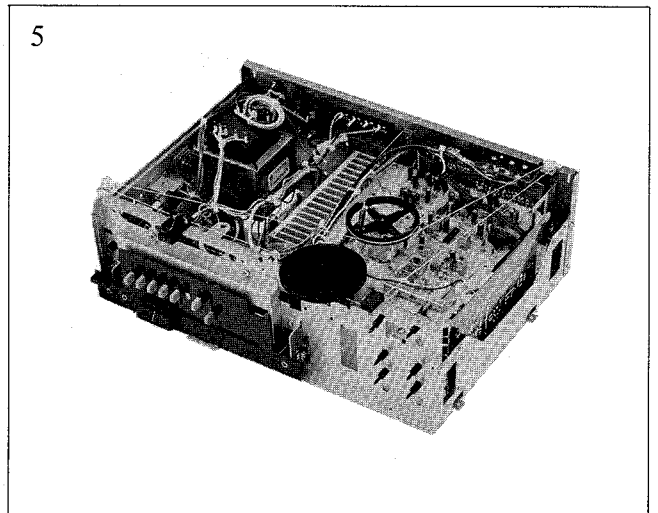
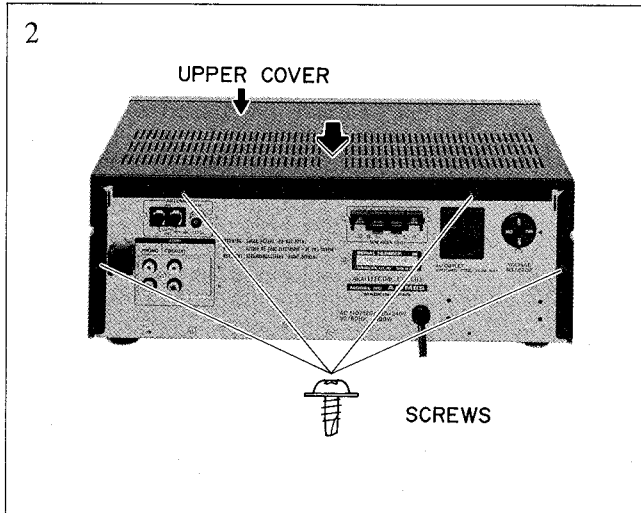
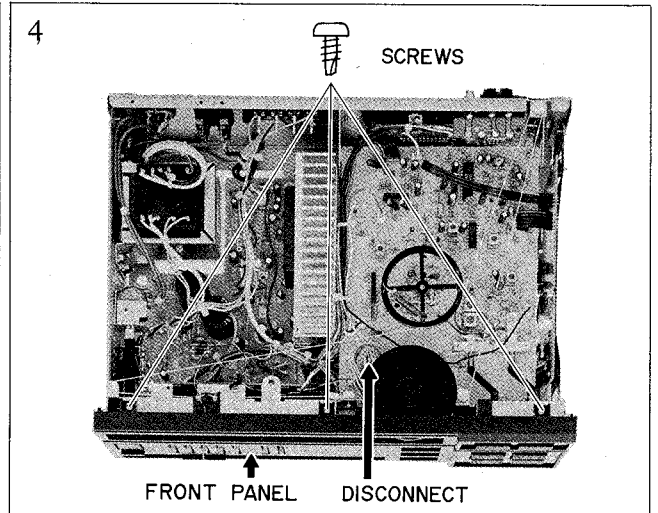
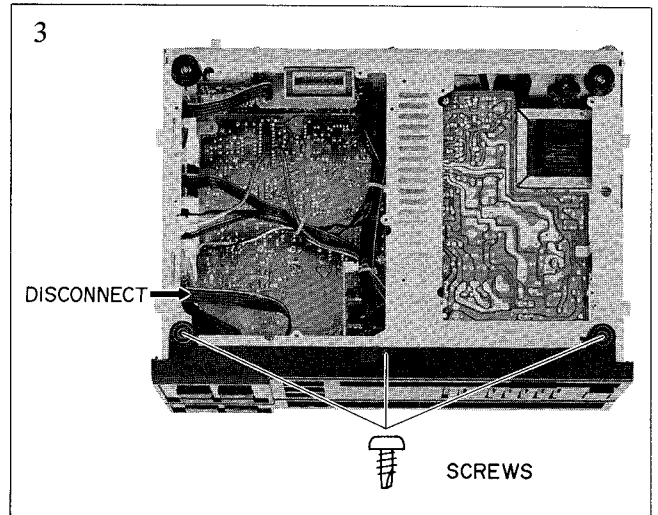
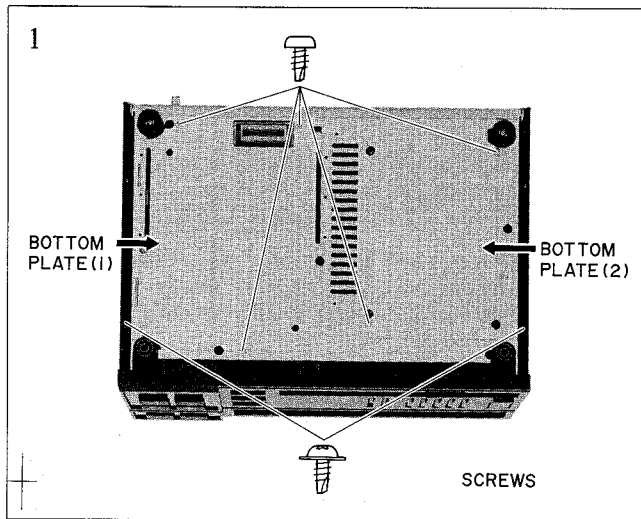

III. CONTROLS

POWER switch

To turn on and off the Akai AA-M8S.

Commutateur d'alimentation (POWER)

Pour mettre sous tension et hors circuit le AA-M8S Akai.

GRAPHIC EQUALIZER Frequency Level Controls (100Hz to 10kHz)

To boost (increase) or cut (decrease) the indicated frequency levels.

Contrôles de niveau de fréquence de l'égaliseur graphique (100 Hz à 10 kHz)

Pour élever ou décroître les niveaux de fréquence indiqués.

Tuning scale

Shows the band and the frequency.

Echelle de syntonisation (TUNING)

Montre la bande et la fréquence.

Tuning indicator

Shows you the tuning frequency.

Indicateur de syntonisation

Vous montre la fréquence de syntonisation.

Lights when an FM stereo broadcast is tuned in.

S'allume quand une émission MF stéréo est syntonisée

Lights when a station is tuned in properly.

S'allume quand une station est syntonisée correctement.

BAND selector

To select the band.

Sélecteur de bande (BAND)

Pour sélectionner la bande.

Shows the band.

Montre la bande.

TUNING control

To tune in a station.

Contrôle de syntonisation (TUNING)

Pour syntoniser une station.

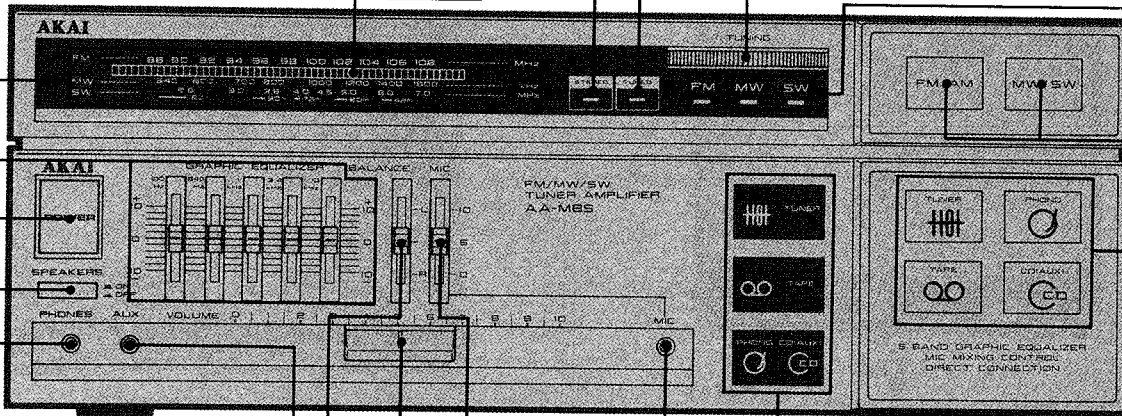

Front AUX jack (Stereo)

Jack AUX frontal (stéréo)

PHONES jack

For listening through headphones.

Jack de casque (PHONES)

Pour une écoute au casque.

BALANCE control

To adjust the left and right channel balance.

Commande d'équilibre (BALANCE)

Pour régler l'équilibre des canaux gauche et droit.

SPEAKERS(ON / OFF) switch

To turn on and off the speaker system.

When using the headphones, set this switch to OFF ().

Commutateur marche/arrêt haut-parleurs (SPEAKERS ON /OFF)

Pour mettre sous tension et hors circuit le système d'enceintes.

Réglez ce commutateur sur arrêt (OFF) lors de l'utilisation d'un casque.

MIC level control

To adjust the microphone level when microphone mixing.

Commande de niveau microphone (MIC LEVEL)

Pour régler le niveau microphone lors d'un mixage au microphone.

VOLUME control

To adjust the volume level.

Commande de VOLUME

Pour régler le niveau de volume.

Input Source Indicators

Light to indicate which input source has been selected.

Indicateurs de source d'entrée

S'allument pour indiquer quelle source d'entrée a été sélectionnée.

MIC jack

For microphone mixing.

Jack micro (MIC)

Pour un mixage au microphone

Input source selectors (TAPE, CD(AUX), TUNER and PHONO)

To select the audio source you want to listen to.

Sélecteurs de source d'entrée (bande (TAPE), AUX, TUNER et PHONO)

Pour sélectionner la source que vous désirez écouter.

Fig. 3-1 Front View

IV. PRINCIPAL PARTS LOCATION

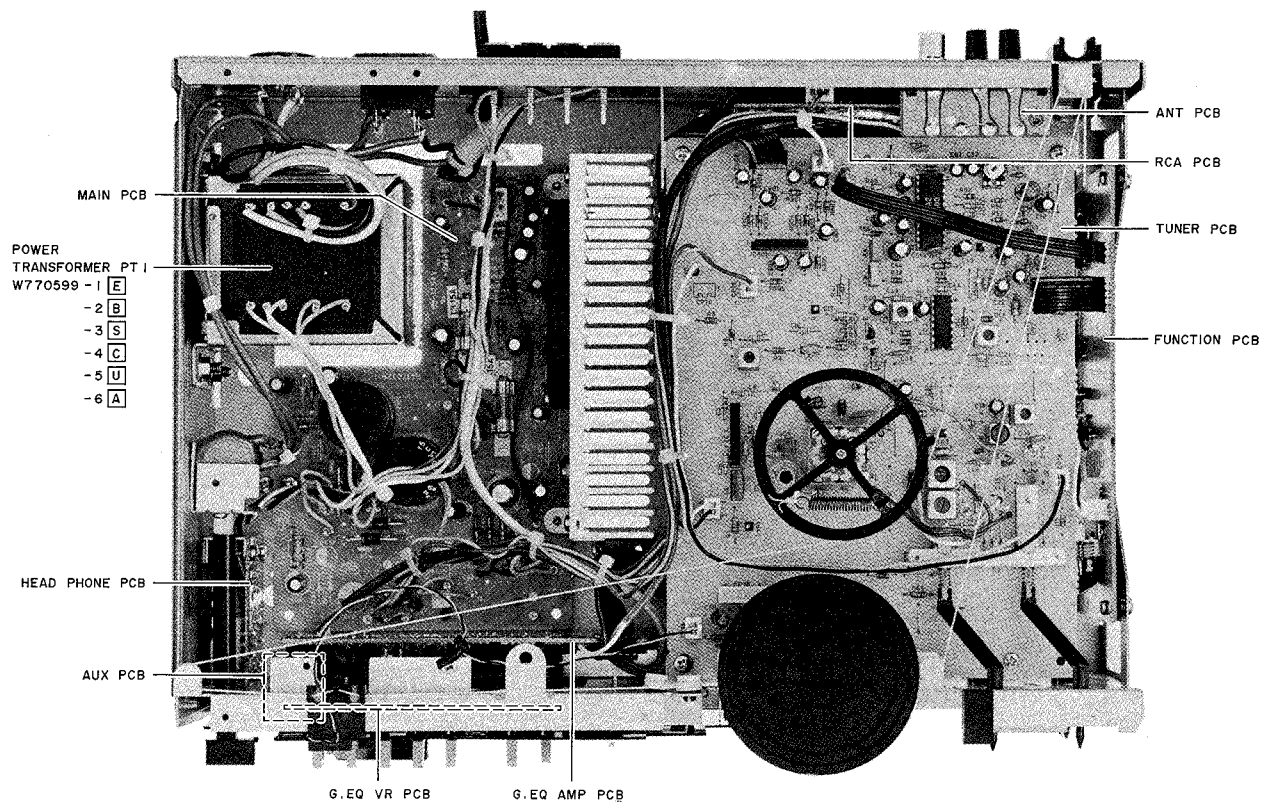

Fig. 4-1 Top View

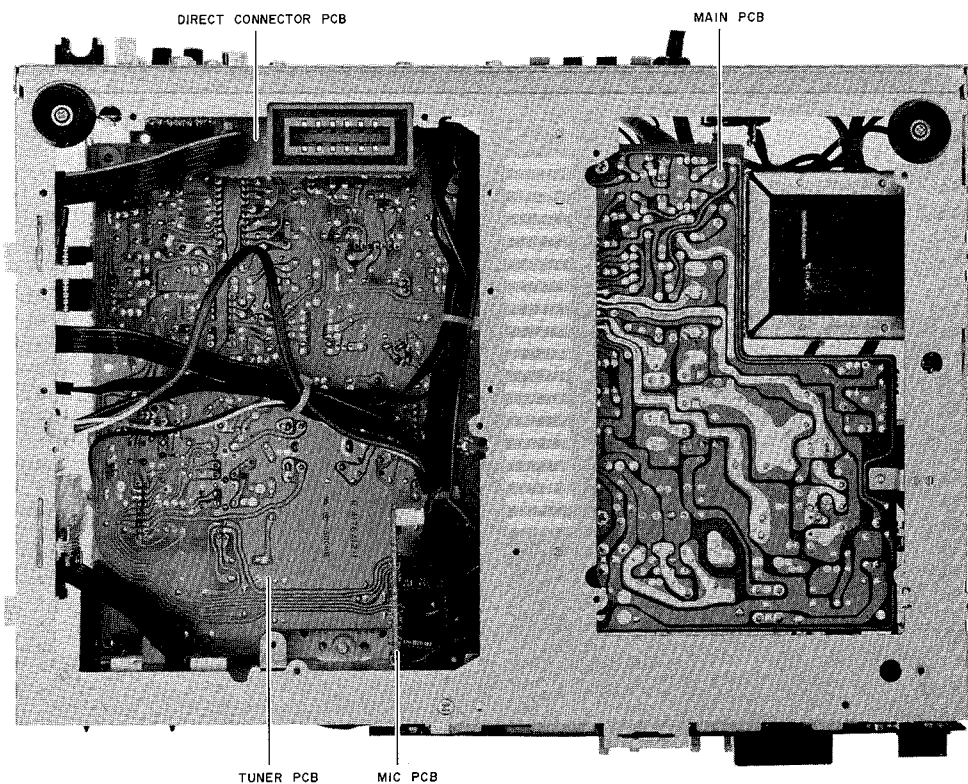
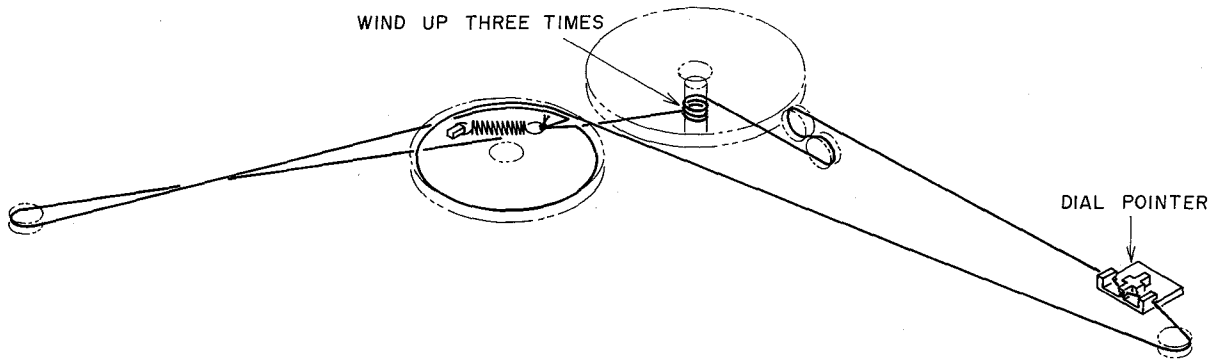

Fig. 4-2 Bottom View

V. DIAL CORD THREADING



VI. ADJUSTMENTS

6-1. INSTRUMENT CONNECTIONS

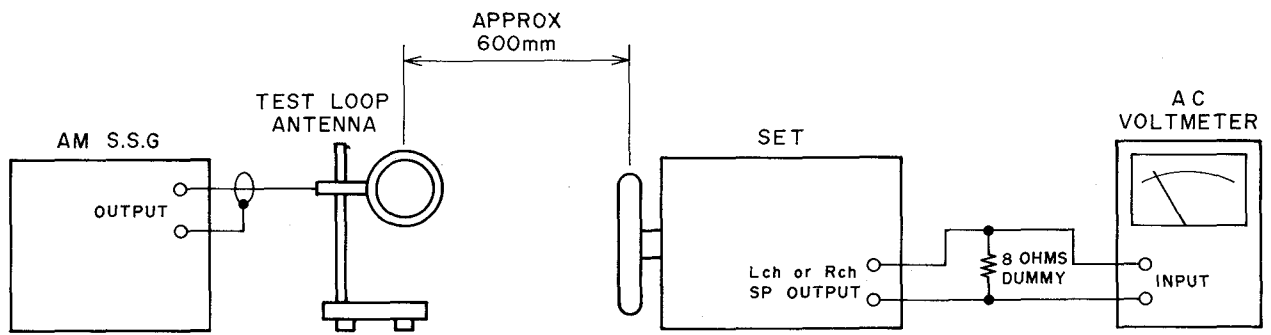

Fig. 6-1 Instruments Connection for AM (MW)/LW/SW Section Adjustments

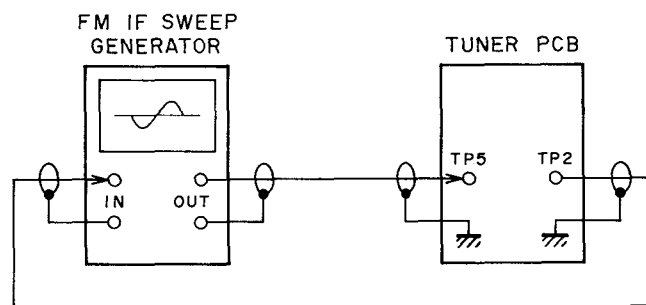

Fig. 6-2 Instruments Connection for FM IF Adjustment

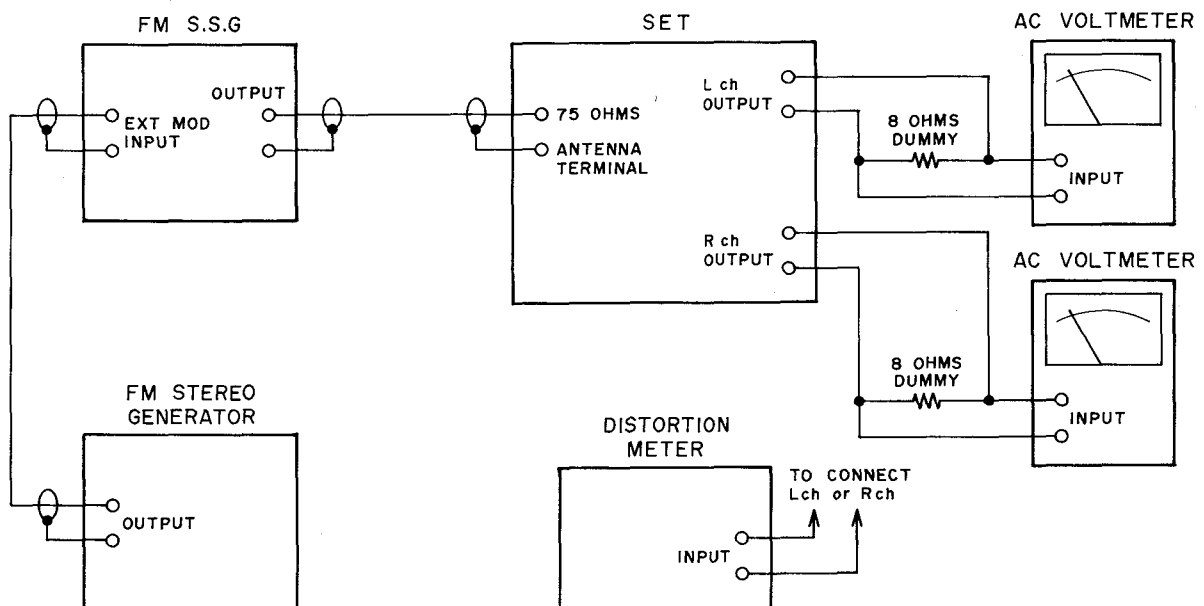

Fig. 6-3 Instruments Connection for FM Section Adjustments

6-2. TUNER PC BOARD ADJUSTMENT POINTS

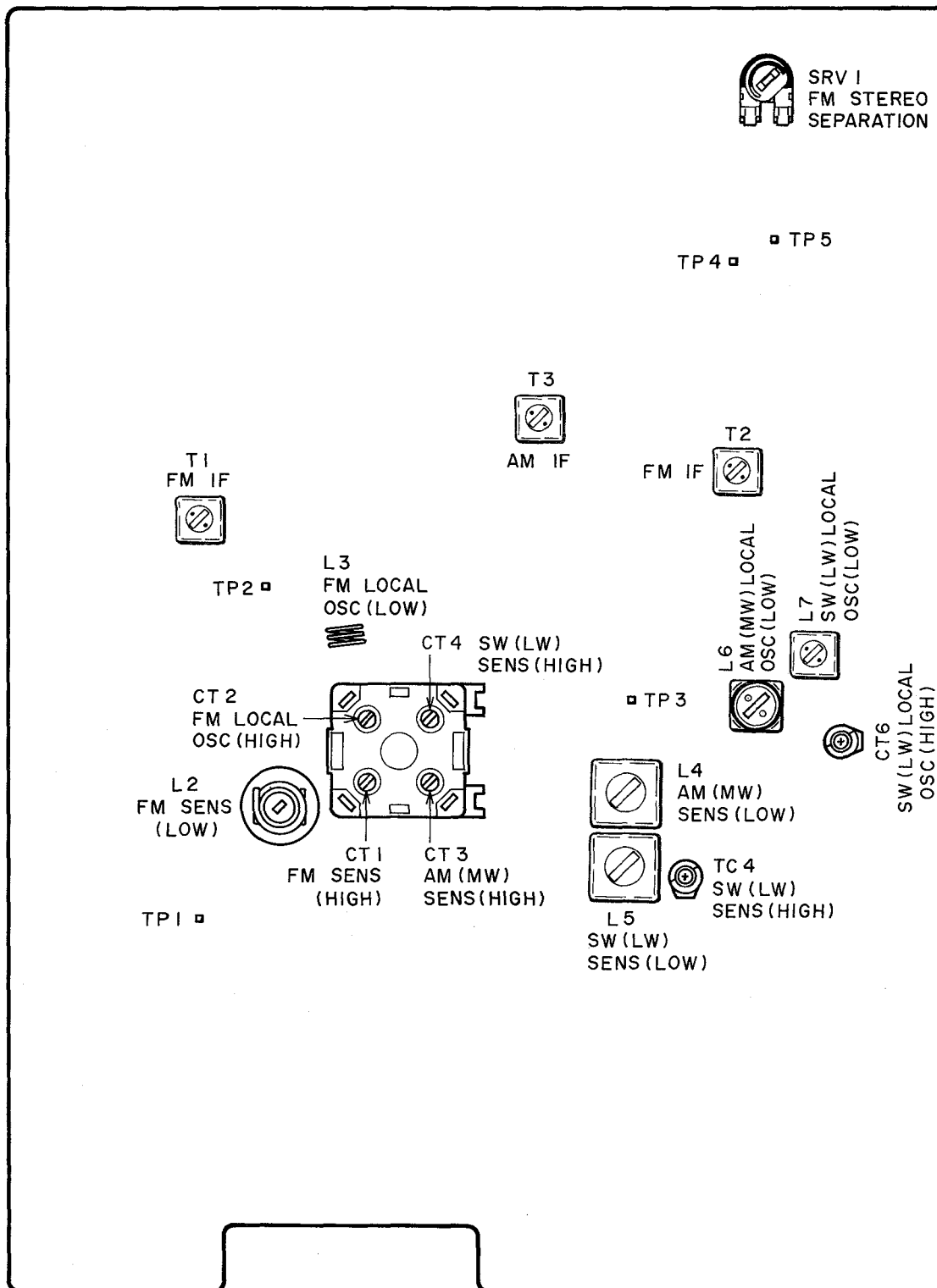

Fig. 6-4 TUNER PCB Adjustment Points

6-3. AM (MW, SW, & LW) SECTION ADJUSTMENTS

- NOTE: 1. Set the internal modulation of S.S.G (Stand Signal Generator) to 400Hz, 30% modulation.
 2. Set FUNCTION switch of AA-M8S/L to TUNER.
 3. Result of all adjustments below are bring to maximum output level and minimum Distortion.
 4. SW BAND is available for model AA-M8S, and LW BAND is available for model AA-M8L only.

Step	Adjustment	S.S.G		SET		Adjustment Part	Remarks
		Frequency	ATT	Band SW	Dial Pointer		
1	MW IF	460kHz	120dB	MW	Low end	T3	
2	MW Local OSC (Low)	515kHz	90dB	MW	Low end	L6	* For best Result, Repeat alternately two or three times.
	MW Local OSC (High)	1650kHz	90dB	MW	High end	CT5	
3	MW Low Range Sensitivity	600kHz	80dB	MW	TUNE 600kHz	L4	* For best Result, Repeat alternately two or three times.
	MW High Range Sensitivity	1400kHz	80dB	MW	TUNE 1400kHz	CT3	
4	SW (LW) Local OSC (Low)	2.1MHz (SW)	90dB	SW	Low end	L7	* For best Result, Repeat alternately two or three times.
		141kHz (LW)	100dB	LW			
	SW (LW) Local OSC (High)	7.5MHz (SW)	90dB	SW	High end	CT6	
		360kHz (LW)	100dB	LW			
5	SW (LW) Low Range Sensitivity	2.5MHz (SW)	80dB	SW	TUNE 2.5MHz	L5	* For best Result, Repeat alternately two or three times.
		155kHz (LW)	90dB	LW	TUNE 155kHz		
	SW (LW) High Range Sensitivity	6.5MHz (SW)	80dB	SW	TUNE 6.5MHz	CT4	* For best Result, Repeat alternately two or three times.
		355kHz (LW)	90dB	LW	TUNE 355kHz		

6-4. FM SECTION ADJUSTMENTS

- NOTE: 1. Set the internal modulation of S.S.G to 1kHz, 75kHz diviation.
 2. Set the STEREO S.S.G is PILOT (6.75kHz diviation) and signal 1kHz 68.25kHz dev.
 3. Set the FUNCTION switch to TUNER.
 4. Result of all adjustment below are bring to maximum output level and Minimum distortion.

Step	Adjustment	S.S.G		SET	Dial Pointer	Adjustment	Remakrs
		Frequency	ATT	Band SW		Part	
1	FM IF	Use FM IF sweep Generator as shown Fig. 4-2.		FM		T1,T2	
2	FM Local OSC (Low)	87.0MHz (MONO)	50 to 20dBf	FM	Low end	L3	* For best Result, Repeat alternately two or three times.
	FM Local OSC (High)	109.0MHz (MONO)	50 to 20dBf	FM	High end	CT2	
3	FM Low Range Sensitivity	90.0MHz (MONO)	Less than 22dBf	FM	Tune 90.0MHz	L2	* For best Resutl, Repeat alternately two or three times.
	FM High Range Sensitivity	106.0MHz (MONO)	Less than 22dBf	FM	Tune 106.0MHz	CT1	
4	Stereo Separation	88.0MHz (stereo)	65.2 dBf	FM	Tune 88.0MHz L or R CH.	SVR1	* NO signal channel is minimum output level.

VII. PC BOARD TITLE AND IDENTIFICATION NUMBERS

PC BOARD TITLE	PC BOARD NUMBER	REMARKS
FUNCTION SW	PC BOARD R4176329-1	
DIRECT CONNECTOR	PC BOARD R4176329-2	
LED 2	PC BOARD R4176329-3	
HEADPHONE	PC BOARD R4176329-4	
G.EQ-VR	PC BOARD R4176329-5	
G.EQ AMP	PC BOARD R4176329-6	
AUX JACK	PC BOARD R4176329-7	
MIC	PC BOARD R4176329-8	
RCA	PC BOARD R4176329-9	
POINTER	PC BOARD R4176329-10	
MAIN	PC BOARD R4176329-1	
ANT	PC BOARD R4176329-2	
TUNER	PC BOARD R4176412-1	
LED 1	PC BOARD R4176412-2	

SECTION 2

PARTS LIST

TABLE OF CONTENTS

RECOMMENDED SPARE PARTS	15
1. PC BOARD BLOCK	16
2. MAIN PC BOARD	16
3. TUNER PC BOARD	16
4. FUNCTION SW PC BOARD	16
5. RCA PC BOARD	16
6. G.EQ AMP PC BOARD	16
7. G.EQ VR PC BOARD	16
8. MIC PC BOARD	16
9. HEAD PHONE PC BOARD	16
10. LED (1) PC BOARD	16
11. LED (2) PC BOARD	17
12. DIRECT CONNECTOR PC BOARD	17
13. AUX JACK PC BOARD	17
14. ANTENNA PC BOARD	17
15. POINTER PC BOARD	17
16. FUSE PC BOARD	17
17. ASSEMBLY BLOCK	18
18. FINAL ASSEMBLY BLOCK	19
INDEX	20

Resistor and Capacitor which is not listed in this parts list, please refer to
COMMON LIST FOR SERVICE PARTS.

ATTENTION

1. When placing an order for parts, be sure to list the parts no., model no., and description of each part. If any of this information is omitted, there are instances in which parts cannot be shipped or the wrong parts will be delivered.
2. Please be careful not to make a mistake in the parts no. If the parts no. is in error, a part different from the one ordered may be delivered.
3. Because part numbers and part definitions and supply in the Preliminary Parts List may have been the subject of changes, please use this parts list for all future reference.

HOW TO USE THIS PARTS LIST

1. This Parts List shows those parts which are considered necessary for repairs. Other parts, such as resistors and capacitors, are shown in the "Common List for Service Parts" from which these parts should be selected and parts.
2. The Recommended Spare Parts List shows those parts in the Parts List which are considered particularly important for service.
3. Parts not shown in the Parts List and "Common List for Service Parts" will not in principle be supplied.
4. How to read the parts list
 - a) Mechanism Block
 - b) P.C Board Block

2. HEAD BASE BLOCK

REF. NO.	PART NO.	DESCRIPTION
2-1x	BH-T2023A320A	HEAD BASE BLOCK GX-F66R
2-2	HP-H2206A010A	HEAD R/P PR4-8FU C
2-3	ZS-477876	PAN20x03STL CMT
2-4	ZS-536488	BID20x08STL CMT
2-5	ZG-402895	CS ANGLE ADJUST SPRING

SP (Service Parts) Classification

A small "x" indicates the inability to show that particular part in the Photo or Illustration.

This number corresponds with the individual parts index number in that figure

This number corresponds with the Figure Number

6. SYS. CON. P C BOARD BLOCK

REF. NO.	PART NO.	DESCRIPTION
6-1	BA-T2034A070A	PC SYS CON BLK GX-F44R
6-IC1	EI-324536	IC HD14049BP
6-IC2	EI-336801	IC MB8841-564M
6-IC3	EI-331661	IC SN7405N
6-IC4	EI-336725	IC M54527P
6-TR1to4	ET-200985	TR 2SC2603 F,G
6-TR5to28	ET-554657	TR 2SA733A P,Q
6-D1	ED-318292	D SILICON H 1S2473T-77 T26
6-D2to4	ED-308952	D GERMA V 1K34A-LR F07
6-D5to10	ED-318292	D SILICON H 1S2473T-77 T26
6-X1	EI-318384	OSC X'TAL NC-18C 3.579545MHZ

SP (Service Parts) Classification

These reference symbols correspond with component symbols in the Schematic Diagrams.

5. The kind of part and its installation position can both be determined by the Part Number. To determine where a part number is listed, utilize the Parts Index at the end of the Parts List. It is necessary first of all to find the Part Number. This can be accomplished by using the Reference Number listed at the right of the part number in the Parts Index.

WARNING

△ INDICATES SAFETY CRITICAL COMPONENTS. FOR CONTINUED SAFETY, REPLACE SAFETY CRITICAL COMPONENTS ONLY WITH MANUFACTURE'S RECOMMENDED PARTS

AVERTISSEMENT

△ IL INDIQUE LES COMPOSANTS CRITIQUES DE SÉCURITÉ. POUR MAINTENIR LE DEGRÉ DE SÉCURITÉ DE L'APPAREIL, NE REMPLACER QUE DES PIÈCES RECOMMANDÉES PAR LE FABRICANT

RECOMMENDED SPARE PARTS

Because, if the parts listed below are on hand, almost any repair can be accomplished, we suggest that you stock these Recommended Spare Parts Items.

REF. NO.	PART NO.	DESCRIPTION
1 N	BT-715888	△ TRANS POWER R-W770599-1 (E) [E]
2 N	BT-715886	△ TRANS POWER R-W770599-2 (B) [B]
3 N	BT-715839	△ TRANS POWER R-W770599-3 [S]
4 N	BT-715837	△ TRANS POWER R-W770599-4 (C) [C]
5 N	BT-715818	△ TRANS POWER R-W770599-5 (U) [U]
6 N	BT-715833	△ TRANS POWER R-W770599-6 (A) [A]
7	EC-749968	C S-FIX
8 N	ED-714991	D LED SLP-173B-01 RED
9 N	ED-714990	D LED SLP-723B-01 GREEN
10 N	ED-714992	D LED SLP-436C-50 AMBER
11 N	ED-714989	D LED SLP-473B-01 AMBER
12	ED-337414	D LED SLP235B GREEN
13	ED-357754	D SILICON DS135D 200/1.0A
14	ED-327057	D SILICON H DS442X
15 N	ED-715933	D SILICON H S3V20
16	ED-345552	D VARACTOR 1S553T
17	ED-712909	D ZENER H GZA20 Y
18	ED-710974	D ZENER H GZA8.2 Y
19 N	EE-715826	VC POLY R-C1755-1
20	EF-623103	△ FUSE SEMKO T 1.00A 250V [U,E,B,S]
21	EF-691007	△ FUSE SEMKO T 3.15A 250V [U,E,B,S]
22	EF-323616	△ FUSE ST6 125V 3.00A [C,A]
23	EF-710905	△ FUSE 125V 2.5A [C]
24 N	EH-714999	FILTER CE 10.7MHz
25	EH-715003	FILTER CE 460kHz
26 N	EI-714983	IC BA3812L
27 N	EI-715892	IC LA1261
28 N	EI-715008	IC LA3400
29 N	EI-714974	IC LC4066B
30 N	EI-714969	IC L78M15
31	EI-714731	IC M5218L
32 N	EI-715019	IC STK4151 (2)
33 N	EI-713319	IC TA7358AP
34 N	EI-715891	OSC CE
35	EJ-356521	SOCKET CONNECTER-B M1701-A 12P
36	ER-714714	△ R FUSE FMR 1/2W 100 [U]
37	ER-711169	△ R FUSE H 1/2W 4R7J [E,B,S]
38	ER-308898	△ R FUSE RF25SJ 1/4W 101J
39	ES-710966	△ SW ROTARY R-S47646-1 [U]
40	ES-712932	SW PUSH
41 N	ES-715831	SW PUSH R-S47028
42 N	ES-715821	SW PUSH R-S470281
43 N	ES-714966	SW PUSH SDL1P 4A/32A 250
44 N	ET-715009	TR FET 2SK315 E
45 N	ET-714975	TR JC501 R
46	ET-403413	TR 2SC536NP H
47	ET-711090	TR 2SC930E-SP
48 N	EV-715006	R S-FIX 104
49 N	EV-714985	VR SLIDE 254
50 N	EV-714986	VR SLIDE 503
51 N	EV-714981	VR SLIDE 503x2
52 N	EV-714984	VR SILDE 503x2

"NOTE" N: New Parts

SYMBOL FOR DESTINATION

- [A] : AAL (USA)
- [B] : UK (England)
- [C] : CSA (Canada)
- [E] : CEE (Europe)
- [S] : SAA (Australia)
- [U] : U/T (Universal Area)

1. PC BOARD BLOCK

REF. NO.	PART NO.	DESCRIPTION
1-A	BA-715819	PC MAIN BLK AA-M8S [U]
1-B	BA-715834	PC MAIN BLK AA-M8S (C,A) [C,A]
1-C	BA-715840	PC MAIN BLK AA-M8S (S) [E,B,S]
1-2	BA-715820	PC FUNCTION BLK AA-M8S
1-3	BA-715823	PC GRAPHIC EQ(1) BLK AA-M8S
1-4A	BA-715824	PC TUNER BLK AA-M8S [U,C,A,S]
1-4B	BA-715889	PC TUNER BLK AA-M8L [E,B]

2. MAIN PC BOARD

REF. NO.	PART NO.	DESCRIPTION
2-IC601	EI-715019	△ IC STK4151 (2)
2-IC651	EI-714969	△ IC L78M15
2-D611	ED-327057	D SILICON H DS442X
2-D612	ED-357754	D SILICON DS135D 200/1.0A [C,A,E,B,S]
2-D613	ED-357754	D SILICON DS135D 200/1.0A
2-D651		to 654
	ED-715933	D SILICON H S3V20
2-D655,656	ED-712909	D ZENER H GZA20 Y
2-D657		to 660
	ED-357754	D SILICON DS135D 200/1.0A
2-R606	ER-714714	△ R FUSE FMR 1/2W 100 [U]
2-R608	ER-663502	R CB H RD 1/2W 222J
2-R609	ER-666347	R CB H RD 1/2W 102J
2-R610A	ER-658124	△ R OMF H FS 1W 100J [U,C,A]
2-R610B	ER-711169	△ R FUSE H 1/2W 4R7J [E,B,S]
2-R615	ER-539087	△ R OMF H FS 1W 222J
2-R651,652	ER-336841	△ R OMF H SNP FS 1W 332J
2-R653,654	ER-301697	△ R OMF H FS 1W 561J
2-R706	ER-714714	△ R FUSE FMR 1/2W 100 [U]
2-R708	ER-663502	R CB H RD 1/2W 222J
2-R709	ER-666347	R CB H RD 1/2W 102J
2-R710A	ER-658124	△ R OMF H FS 1W 100J [U,C,A]
2-R710B	ER-714970	△ R OMF 1W 4R7J [E,B,S]
2-C651,652	EC-334692	△ C EC V CUT AWA 332M 50DC
2-F601A	EF-691007	△ FUSE SEMKO T 3.15A 250V [U,E,B,S]
2-F601B	EF-323616	△ FUSE ST6 125V 3.00A [C,A]
2-F701A	EF-691007	△ FUSE SEMKO T 3.15A 250V [U,E,B,S]
2-F701B	EF-323616	△ FUSE ST6 125V 3.00A [C,A]

3. TUNER PC BOARD

REF. NO.	PART NO.	DESCRIPTION
3-IC1	EI-713319	IC TA7358AP
3-IC2	EI-715892	IC LA1261
3-IC3	EI-715008	IC LA3400
3-IC801	EI-714731	IC M5218L
3-Q1	ET-711090	TR 2SC930E-SP
3-Q2	ET-715009	TR FET 2SK315 E
3-D1	ED-327057	D SILICON H DS442X
3-D2	ED-345552	D VARACTOR 1S553T
3-D3	ED-327057	D SILICON H DS442X
3-D4	ED-327057	D SILICON H DS442X [E,B]
3-D5	ED-710974	D ZENER H GZA8.2 Y
3-D101	ED-327057	D SILICON H DS442X
3-S2	ES-715831	SW PUSH R-S47028
3-L1	EH-715827	FILTER LC
3-L2	EO-714997	COIL VHF
3-L3	EO-715828	COIL VHF
3-L4	EO-715024	COIL ANT 27187-01
3-L5A	EO-716314	COIL ANT SW [U,C,A,S]
3-L5B	EO-707990	COIL TUN [L]
3-L6	EO-715025	COIL OSC MW 87079-2
3-L7A	EO-715830	COIL OSC SW1 87078 [EXCEPT L]
3-L7B	EO-715890	COIL OSC LW [L]
3-L8,L9	EO-711971	COIL CHOKE 10MH
3-L10	EO-707225	COIL FIX [E,B]

REF. NO.	PART NO.	DESCRIPTION
3-T1	EO-714998	COIL IFT FM 5T766-5
3-T2	EO-715040	COIL IFT FMT 5T7074-1
3-T3	EO-707230	COIL IFT
3-X1,X2	EH-714999	FILTER CE 10.7MHz
3-X3	EH-715003	FILTER CE 460kHz
3-X4	EI-715891	OSC CE
3-SVR1	EV-715006	R S-FIX 104
3-CT4	EC-749968	C S-FIX
3-CT6	EC-749968	C S-FIX
3-R1	ER-666347	R CB H RD 1/2W 102J
3-R16	ER-520863	R CB H RD 1/2W 221J
3-R57	ER-308898	R FUSE RF25SJ 1/4W 101J
3-C35	EC-304849	C STY V 361J 50DC
3-C36A	EC-637132	C STY V 122J 50DC [U,C,A,S]
3-C36B	EC-306017	C STY V F05 CQ09S 221J 50DC [E,B]
3-VC	EE-715826	VC POLY R-C1755-1

4. FUNCTION SW PC BOARD

REF. NO.	PART NO.	DESCRIPTION
4-IC251	EI-714974	IC LC4066B
4-Q251	ET-714975	TR JC051 R
4-S251	ES-715821	SW PUSH R-S470281

5. RCA PC BOARD

REF. NO.	PART NO.	DESCRIPTION
5-JK201	EJ-715822	PIN J 4P

6. G.EQ AMP PC BOARD

REF. NO.	PART NO.	DESCRIPTION
6-IC401	EI-714983	IC BA3812L
6-IC501	EI-714983	IC BA3812L
6-VR408	EV-714981	VR SLIDE 503x2

7. G.EQ VR PC BOARD

REF. NO.	PART NO.	DESCRIPTION
7-VR401	EV-714986	VR SLIDE 503
7-VR402	EV-714985	VR SLIDE 254
7-VR403		to 407
	EV-714984	VR SLIDE 503x2

8. MIC PC BOARD

REF. NO.	PART NO.	DESCRIPTION
8-Q461	ET-403413	TR 2SC536NP H
8-JK461	EJ-712930	JACK

9. HEAD PHONE PC BOARD

REF. NO.	PART NO.	DESCRIPTION
9-S631	ES-712932	SW PUSH
9-JK631	EJ-712931	JACK
9-R631	ER-710996	R OMF 1W 331J
9-R731	ER-710996	R OMF 1W 331J

10. LED (1) PC BOARD

REF. NO.	PART NO.	DESCRIPTION
10-D151	ED-714991	D LED SLP-173B-01 RED
10-D152	ED-714990	D LED SLP-273B-01 GREEN

REF. NO. PART NO. DESCRIPTION

10-D153
to 155 ED-714989 D LED SLP-473B-01 AMBER

11. LED (2) PC BOARD

REF. NO. PART NO. DESCRIPTION

11-D271 ED-714992 D LED SLP-436C-50 AMBER
11-D273 ED-714992 D LED SLP-436C-50 AMBER
11-D275,276 ED-714992 D LED SLP-436C-50 AMBER

12. DIRECT CONNECTOR PC BOARD

REF. NO. PART NO. DESCRIPTION

12-JK382 EJ-356521 SOCKET CONNECTOR-B M1701-A 12P

13. AUX JACK PC BOARD

REF. NO. PART NO. DESCRIPTION

13-JK281 EJ-712931 JACK

14. ANTENNA PC BOARD

REF. NO. PART NO. DESCRIPTION

14-JK1 EJ-714988 TERMINAL PLATE

15. POINTER PC BOARD

REF. NO. PART NO. DESCRIPTION

15-D171 ED-337414 D LED SLP235B GREEN

16. FUSE PC BOARD

REF. NO. PART NO. DESCRIPTION

16-C1 EC-338411 Δ C CE V FZ103P 400AC [C,E,B,S]
16-L1 EO-711184 Δ COIL LF [E]
16-F1A EF-623103 Δ FUSE SEMKO T 1.00A 250V [E,B,S]
16-F1B EF-710905 Δ FUSE 125V 2.5A [C]

ASSEMBLY BLOCK

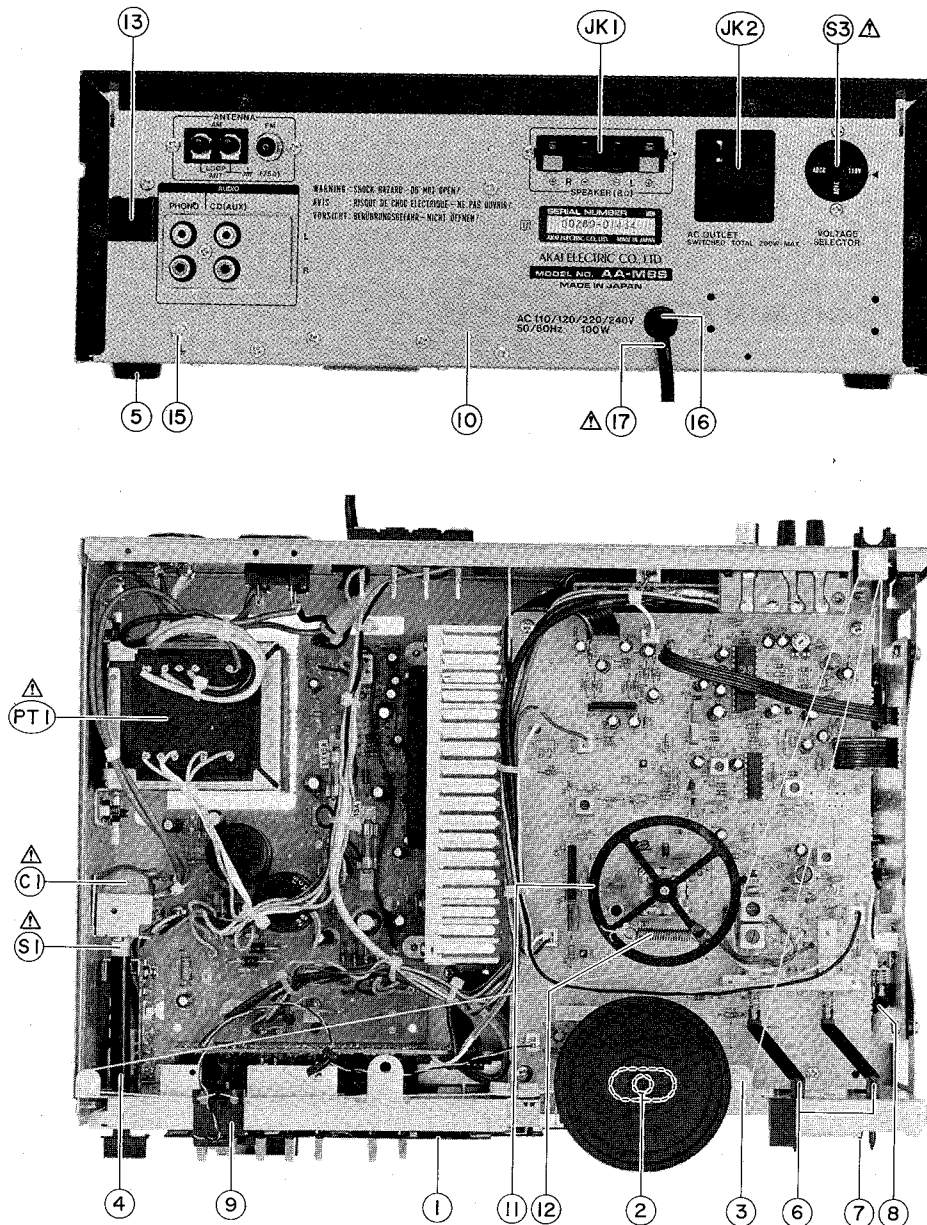

17. ASSEMBLY BLOCK

REF. NO.	PART NO.	DESCRIPTION	REF. NO.	PART NO.	DESCRIPTION
17-1	SE-715813	BACK PLATE	17-17A	EW-707212	△ AC CORD [U]
17-2	MS-715815	SHAFT TUNING ASSY	17-17B	EW-713056	△ AC CORD [C,A]
17-3	TA-707194	PULLEY D7 BLK	17-17C	EW-706423	△ AC CORD [E]
17-4	ML-714956	LEVER SWITCH	17-17D	EW-713107	△ AC CORD [B]
17-5	SA-711043	RUBBER FOOT	17-17E	EW-706424	△ AC CORD [S]
17-6	ML-714957	LEVER SWITCH [FM/AM,MW/SW]	17-PT1A	BT-715818	△ TRANS POWER R-W770599-5 (U)
17-7	ML-714958	LEVER SWITCH [PHONO, CD(AUX)]			[U]
17-8	ML-714959	LEVER SWITCH [TUNER,TAPE]	17-PT1B	BT-715837	△ TRANS POWER R-W770599-4(C)
17-9	MD-714961	POINTER			[C]
17-10A	SP-715816	PANEL REAR AA-M8S (U) [U]	17-PT1C	BT-715833	△ TRANS POWER R-W770599-6(A)
17-10B	SP-715835	PANEL REAR AA-M8S (C) [C]			[A]
17-10C	SP-715832	PANEL REAR AA-M8S (A) [A]	17-PT1D	BT-715888	△ TRANS POWER R-W770599-1 (E)
17-10D	SP-715887	PANEL REAR AA-M8L (E) [E]			[E]
17-10E	SP-715885	PANEL REAR AA-M8L (B) [B]	17-PT1E	BT-715886	△ TRANS POWER R-W770599-2 (B)
17-10F	SP-715838	PANEL REAR AA-M8S (S) [S]			[B]
17-11	MR-715537	DIAL WHEEL	17-PT1F	BT-715839	△ TRANS POWER R-W770599-3 [S]
17-12	ZG-714963	SP COIL	17-JK2	EJ-714965	△ SOCKET OUTLET [U,A]
17-13	SZ-715517	HOLDER ANT	17-JK1	EJ-711054	TERMINAL PUSH 4P
17-14x	EE-712884	ANT LOOP	17-S1	ES-714966	△ SW PUSH SDL1P 4A/32A 250
17-15	ZS-711051	EARTH SCREW	17-S3	ES-710966	△ SW ROTARY R-S47646-1 [U]
17-16	EZ-631945	STRAIN RELIEF SR-4N-4	17-C1	EC-338411	△ C CE V FZ 103P 400AC [U,A]

FINAL ASSEMBLY BLOCK

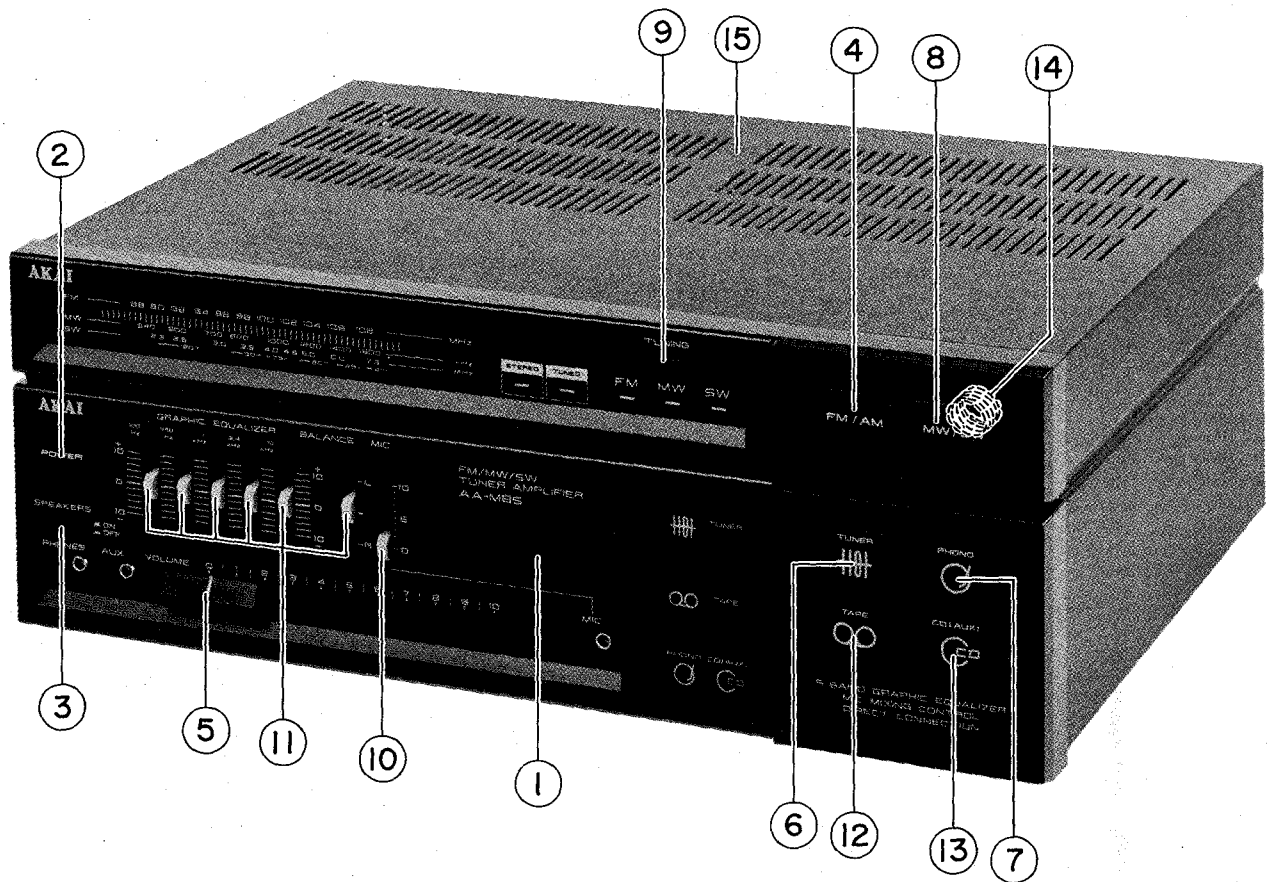

18. FINAL ASSEMBLY BLOCK

REF. NO.	PART NO.	DESCRIPTION
PANEL FRONT PART		
18-1A	BD-715811	PANEL FRONT PART AA-M8S-B [U,C,A,S]
18-1B	BD-715883	PANEL FRONT PART AA-M8L-B [E,B]
FINAL ASSEMBLY BLOCK		
18-2	SK-343017F	KNOB POWER-B
18-3	SK-356619B	KNOB (B)-S
18-4	SK-715510	KNOB FM/AM-B
18-5	SK-715523	KNOB VR
18-6	SK-715524	KNOB TUNER-B
18-7	SK-715525	KNOB PHONO-B
18-8A	SK-715812	KNOB MW/SW [U,C,A,S]
18-8B	SK-715884	KNOB MW/LW [E,B]
18-9	SK-715535	KNOB TUNING
18-10	SK-715534	KNOB MIC
18-11	SK-715532	KNOB EQ
18-12	SK-715530	KNOB TAPE-B
18-13	SK-715531	KNOB CD/AUX-B
18-14	ZG-714955	SP COIL
18-15	SP-715817	COVER UPPER
18-16x	EJ-713009	SOCKET

INDEX

PART NO.	REF. NO.	PART NO.	REF. NO.	PART NO.	REF. NO.	PART NO.	REF. NO.	PART NO.	REF. NO.
BA-715819	1-1A	EJ-713009	18-16	SK-715532	18-11				
BA-715820	1-2	EJ-714965	17-JK2	SK-715534	18-10				
BA-715823	1-3	EJ-714988	14-JK1	SK-715535	18-9				
BA-715824	1-4A	EJ-715822	5-JK201	SK-715812	18-8A				
BA-715834	1-1B	EO-707225	3-L10	SK-715884	18-8B				
BA-715840	1-1C	EO-707230	3-T3	SP-715816	17-10A				
BA-715889	1-4B	EO-707990	3-L5B	SP-715817	18-15				
BD-715811	18-1A	EO-711184	16-L1	SP-715832	17-10C				
BD-715883	18-1B	EO-711971	3-L9	SP-715835	17-10B				
BT-715818	17-PT1A	EO-711971	3-L8	SP-715838	17-10F				
BT-715833	17-PT1C	EO-714997	3-L2	SP-715885	17-10E				
BT-715837	17-PT1B	EO-714998	3-T1	SP-715887	17-10D				
BT-715839	17-PT1F	EO-715024	3-L4	SZ-715517	17-13				
BT-715886	17-PT1E	EO-715025	3-L6	TA-707194	17-3				
BT-715888	17-PT1D	EO-715040	3-T2	ZG-714955	18-14				
EC-304849	3-C35	EO-715828	3-L3	ZG-714963	17-12				
EC-306017	3-C36B	EO-715830	3-L7A	ZS-711051	17-15				
EC-334692	2-C651	EO-715890	3-L7B						
EC-334692	2-C652	EO-716314	3-L5A						
EC-338411	16-C1	ER-301697	2-R654						
EC-338411	17-C1	ER-301697	2-R653						
EC-637132	3-C36A	ER-308898	3-R57						
EC-349968	3-CT6	ER-336841	2-R651						
EC-349968	3-CT4	ER-336841	2-R652						
ED-327057	2-D611	ER-520863	3-R16						
ED-327057	3-D101	ER-539087	2-R615						
ED-327057	3-D4	ER-658124	2-R710A						
ED-327057	3-D1	ER-658124	2-R610A						
ED-327057	3-D3	ER-663502	2-R708						
ED-337414	15-D171	ER-663502	2-R608						
ED-345552	3-D2	ER-666347	2-R609						
ED-357754	2-D658	ER-666347	2-R709						
ED-357754	2-D660	ER-666347	3-R1						
ED-357754	2-D613	ER-710996	9-R631						
ED-357754	2-D612	ER-710996	9-R731						
ED-357754	2-D659	ER-711169	2-R610B						
ED-357754	2-D657	ER-714714	2-R606						
ED-710974	3-D5	ER-714714	2-R706						
ED-712909	2-D656	ER-714970	2-R710B						
ED-712909	2-D655	ES-712932	9-S631						
ED-714989	10-D154	ES-714966	17-S1						
ED-714989	10-D155	ES-714066	17-S3						
ED-714989	10-D153	ES-715821	4-S251						
ED-714990	10-D152	ES-715831	3-S2						
ED-714991	10-D151	ET-403413	8-Q461						
ED-714992	11-D271	ET-711090	3-Q1						
ED-714992	11-D273	ET-714975	4-Q251						
ED-714992	11-D275	ET-715009	3-Q2						
ED-714992	11-D276	EV-714981	6-VR408						
ED-715933	2-D652	EV-714984	7-VR405						
ED-715933	2-D653	EV-714984	7-VR407						
ED-715933	2-D651	EV-714984	7-VR406						
ED-715933	2-D654	EV-714984	7-VR403						
EE-712884	17-14x	EV-714984	7-VR404						
EE-715826	3-VC	EV-714985	7-VR402						
EF-323616	2-F601B	EV-714986	7-VR401						
EF-323616	2-F701B	EV-715006	3-SVR1						
EF-623103	16-F1A	EW-706423	17-17C						
EF-691007	2-F701A	EW-706424	17-17E						
EF-691007	2-F601A	EW-707212	17-17A						
EF-710905	16-F1B	EW-713056	17-17B						
EH-714999	3-X1	EW-713107	17-17D						
EH-714999	3-X2	EZ-631945	17-16						
EH-715003	3-X3	MD-714961	17-9						
EH-715827	3-L1	ML-714956	17-4						
EI-713319	3-IC1	ML-714957	17-6						
EI-714731	3-IC801	ML-714958	17-7						
EI-714969	2-IC651	ML-714959	17-8						
EI-714974	4-IC251	MR-715537	17-11						
EI-714983	6-IC401	MS-715815	17-2						
EI-714983	6-IC501	SA-711043	17-5						
EI-715008	3-IC3	SE-715813	17-1						
EI-715019	2-IC601	SK-343017F	18-2						
EI-715891	3-X4	SK-356619B	18-3						
EI-715892	3-IC2	SK-715510	18-4						
EJ-356521	12-JK382	SK-715523	18-5						
EJ-711054	17-JK1	SK-715524	18-6						
EJ-712930	8-JK461	SK-715525	18-7						
EJ-712931	9-JK631	SK-715530	18-12						
EJ-712931	13-JK281	SK-715531	18-13						

AKAI

MODEL AA-M8S/L

SCHEMATIC DIAGRAM AND PC BOARD

1. BLOCK DIAGRAM OF IC's	1
2. MODEL M8S/L CONNECTION	2
3. AUX JACK PCB, DIRECT CONNECTOR PCB, FUNCTION SW PCB, FUSE PCB, G-EQ-AMP PCB, G-EQ-VR PCB, HEADPHONE PCB, LED2 PCB, MAIN PCB, MIC PCB, RCA PCB	3
4. AA-M8S TUNER SCHEMATIC DIAGRAM	4
5. ANT TERMINAL PCB, POINTER LED PCB, LED I PCB, TUNER PCB ...	5
6. AA-M8S TUNER SCHEMATIC DIAGRAM	6
7. ANT TERMINAL PCB, POINTER LED PCB, LED I PCB, TUNER PCB ...	7
8. AA-M8S/L BLOCK DIAGRAM	8

BLOCK DIAGRAM OF IC'S

NAME OF IC	FUNCTION
BA3812L	5 spots Graphic Equalizer
LA1261	FM/AM IF, Quadrature Detector
LA3400	FM MPX
M5218L	Dual Low noise OP-Amp
STK4151-II	Audio Signal power Amp
TA7358AP	FM RF Amp, MIX, Local OSC
TC4066BP	Quad Bilateral Switch (Analogue Switch)

AA-M8S/L

STK4151II

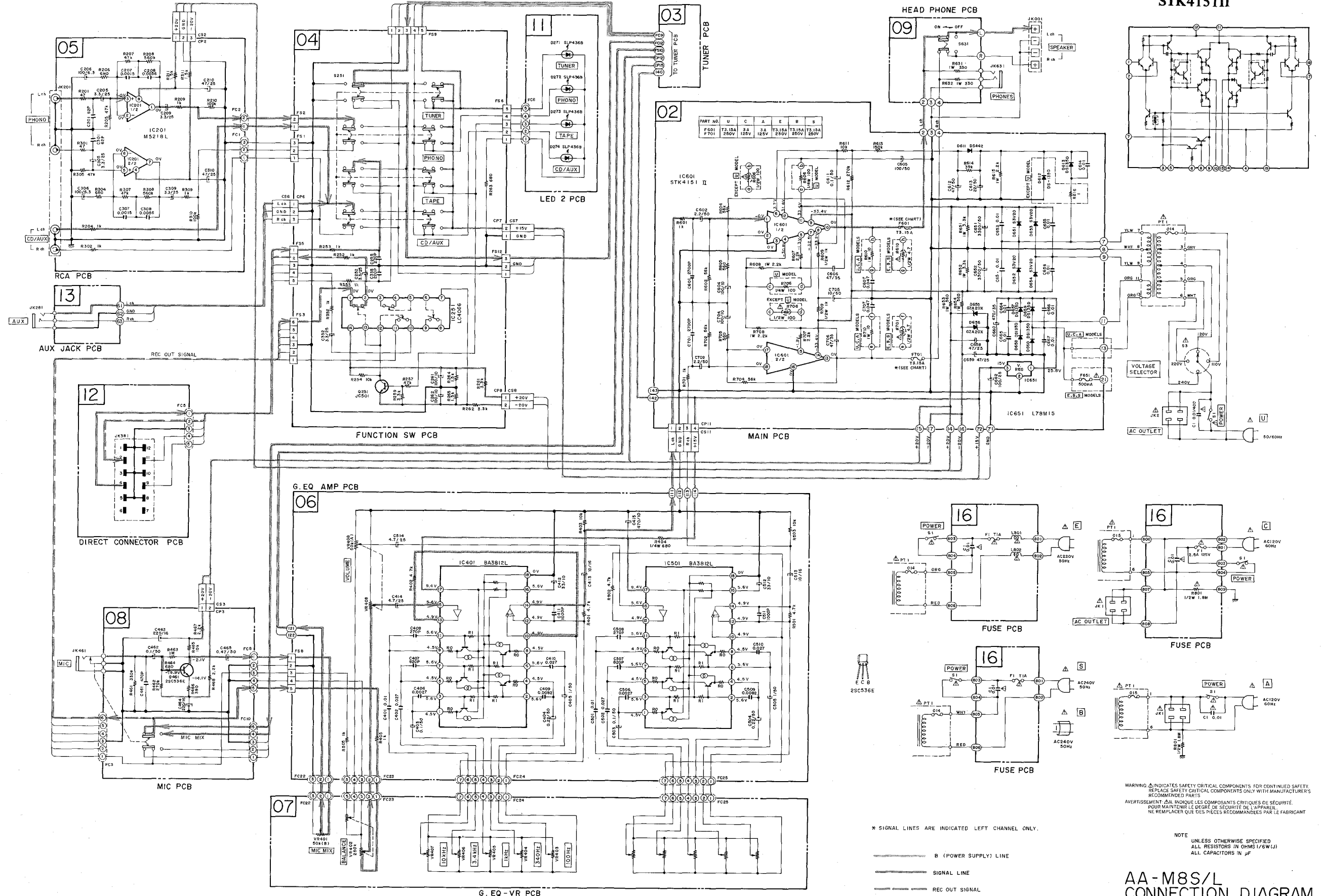

AA-M8S/L CONNECTION DIAGRAM NO. 3-1 850401A

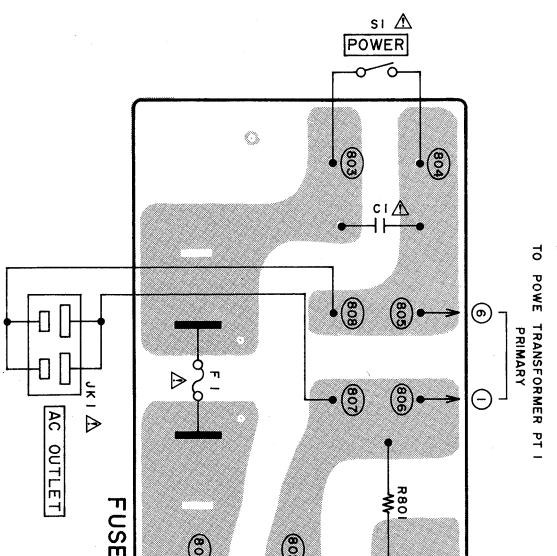
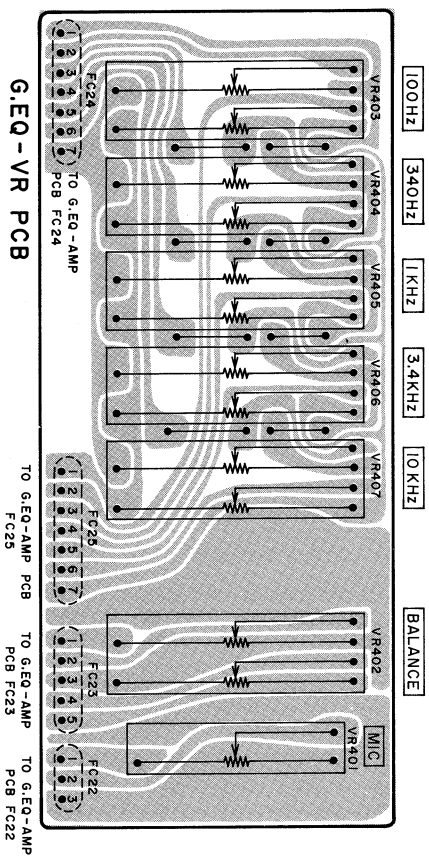
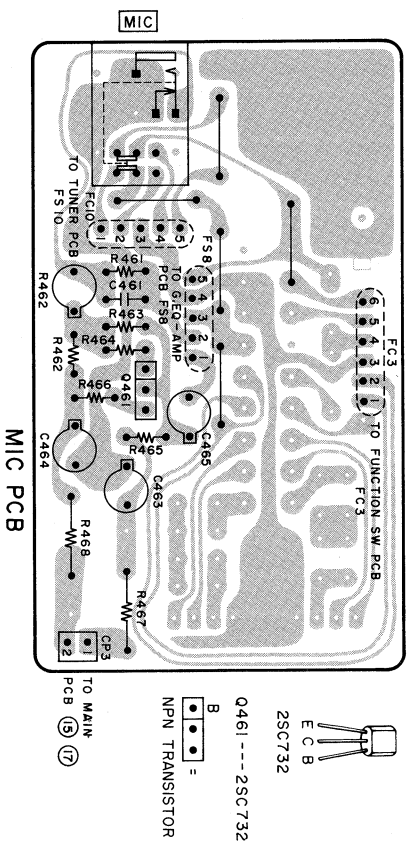
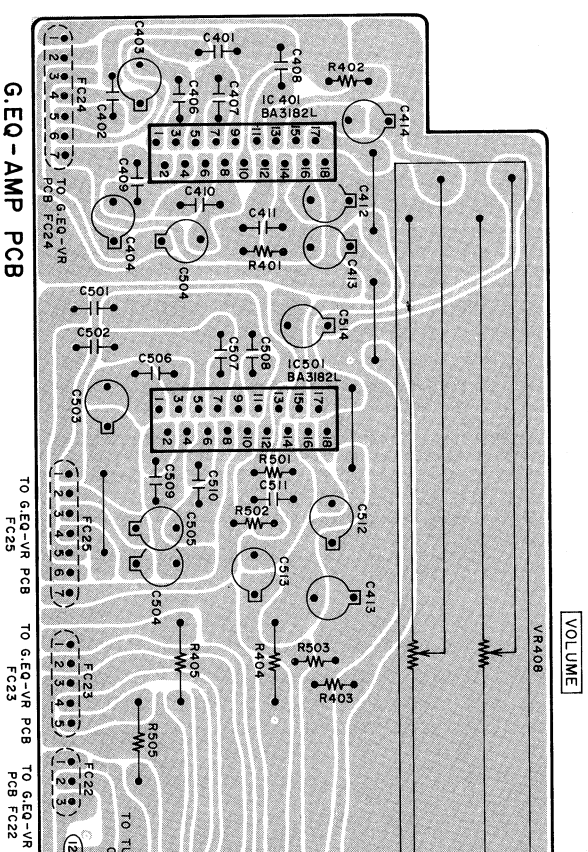
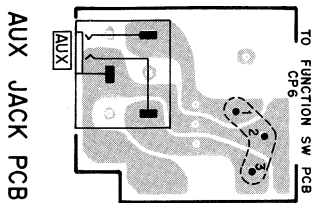
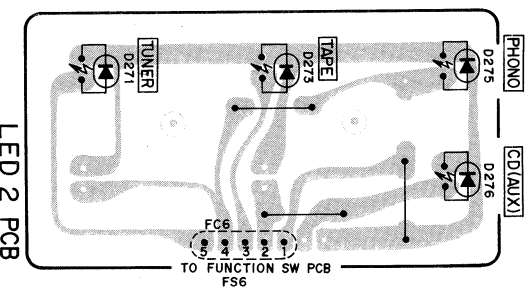
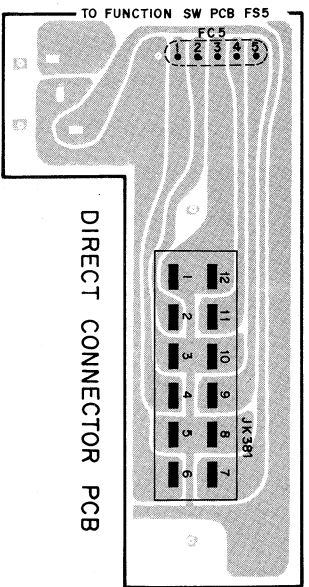
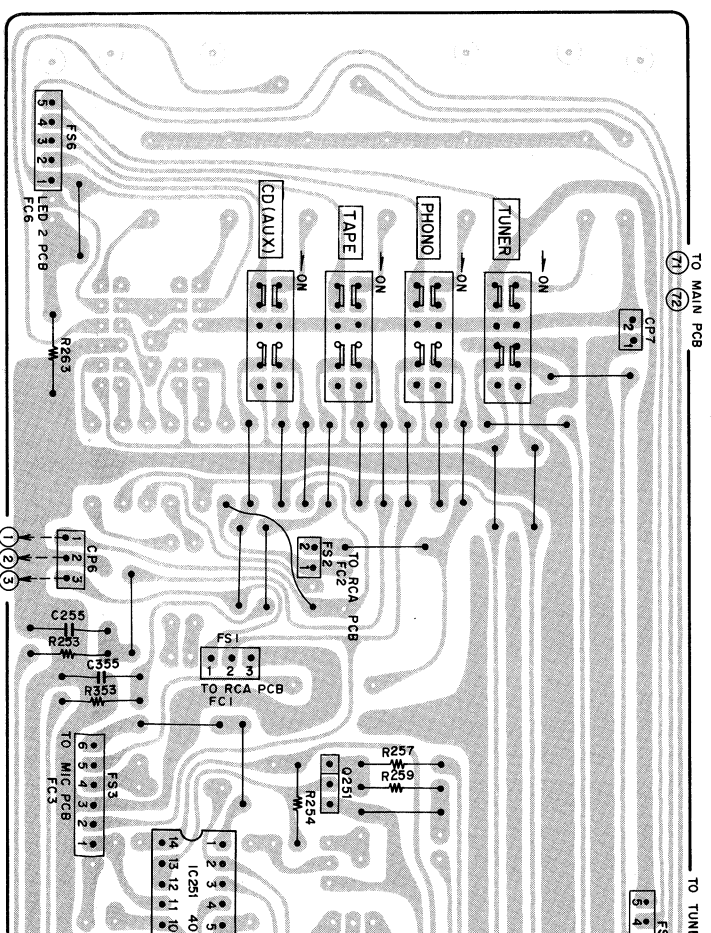
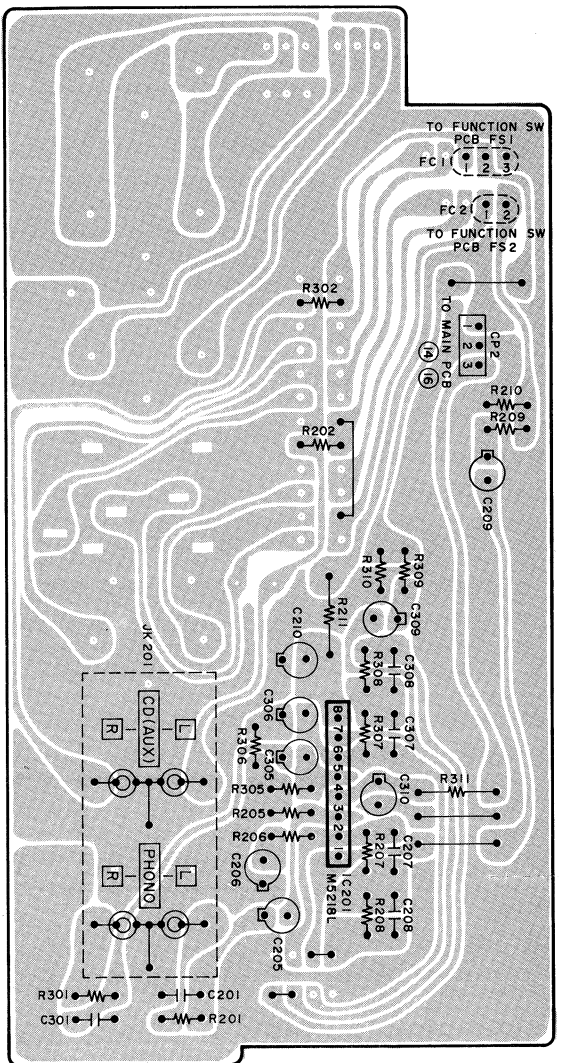

Q461---2SC732
B
NPN TRANSISTOR

2SC732

E C B

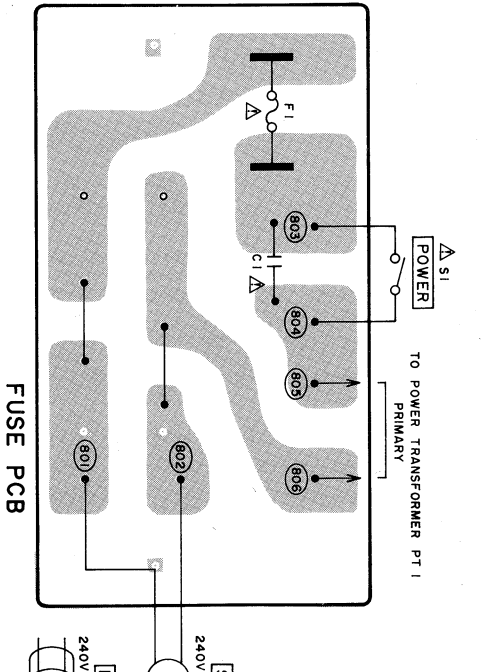
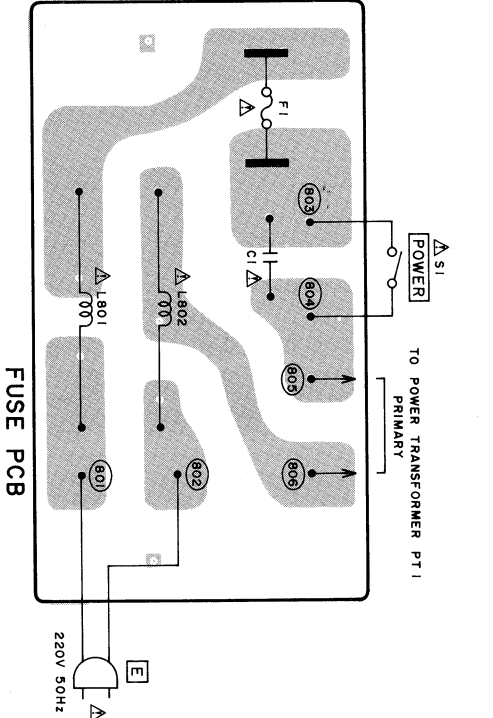
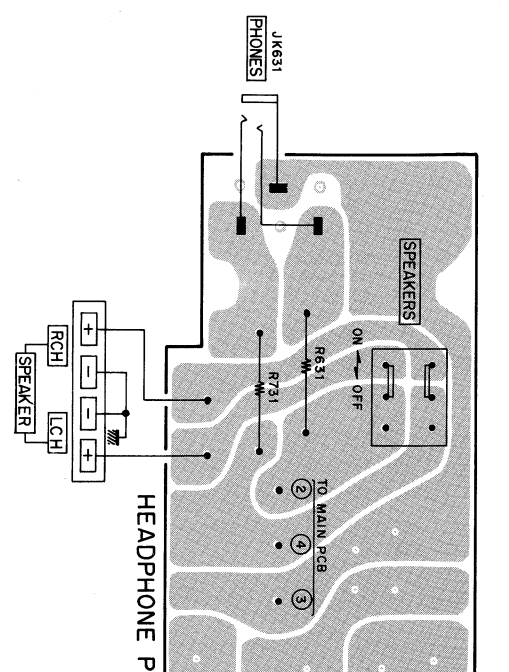
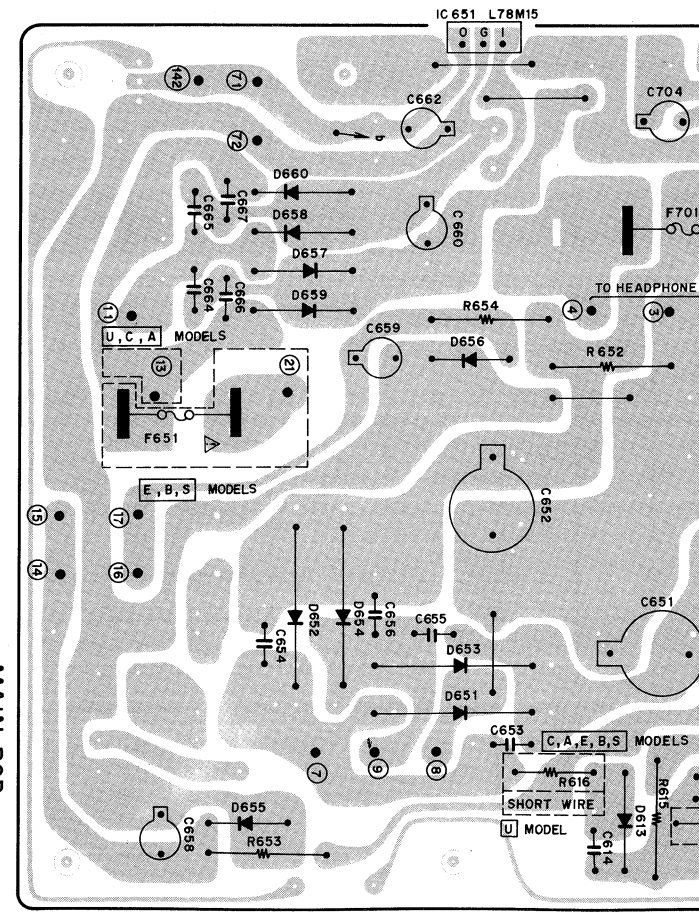
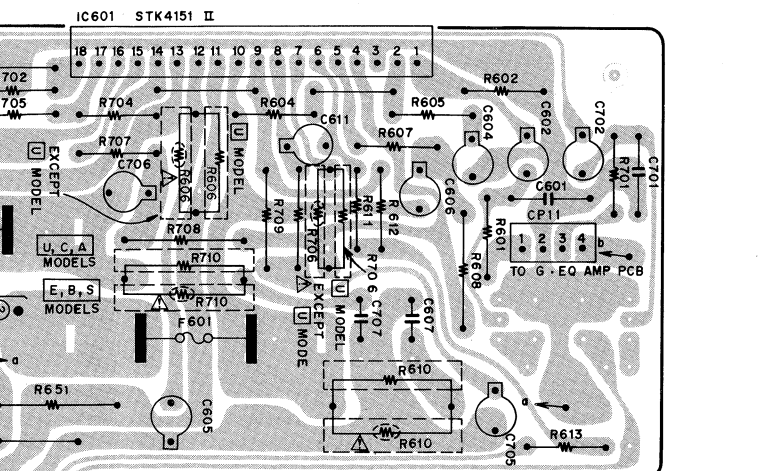
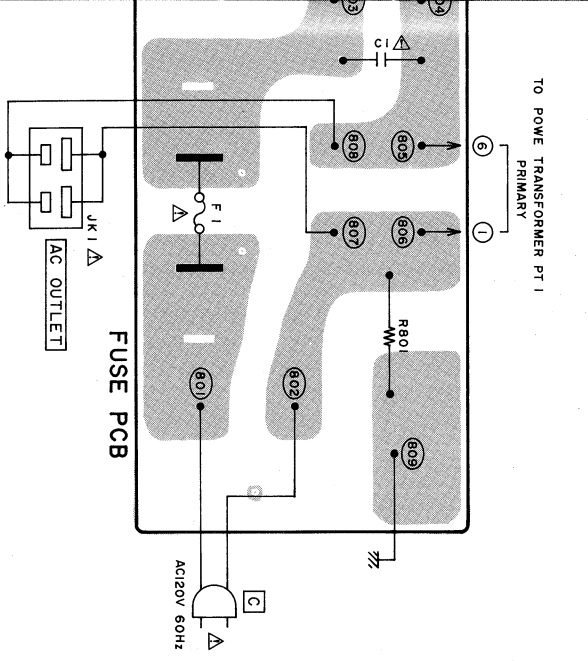
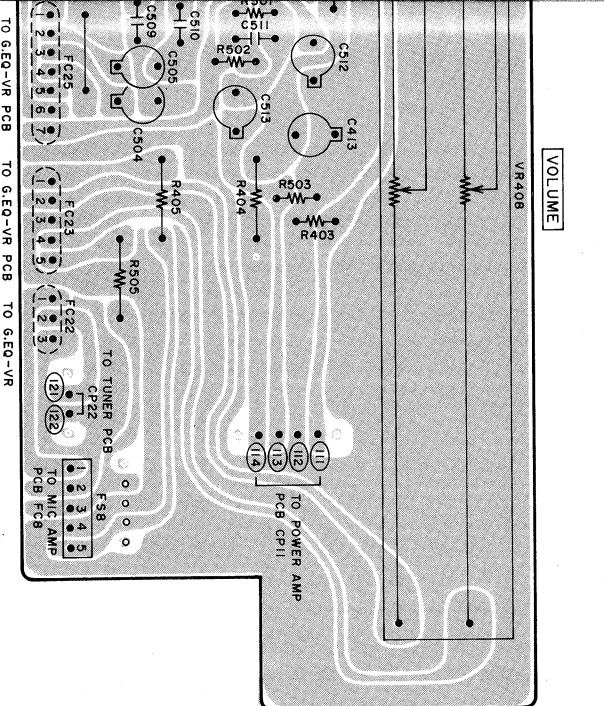
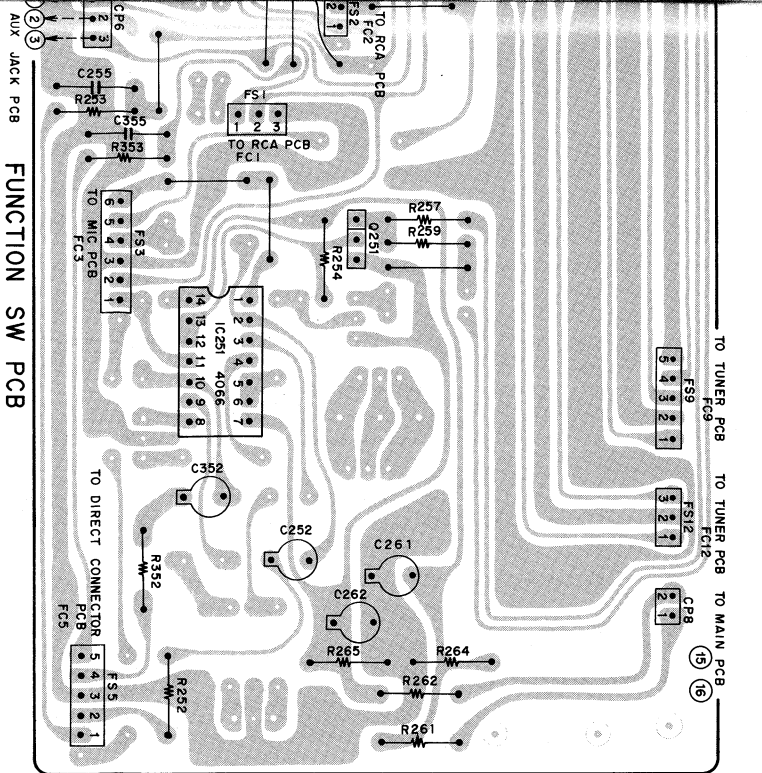

WARNING: Δ INDICATES SAFETY CRITICAL COMPONENTS FOR CONTINUED SAFETY. REPLACE SAFETY CRITICAL COMPONENTS ONLY WITH MANUFACTURERS' RECOMMENDED PARTS.
AVERTISSEMENT: Δ IL INDIQUE LES COMPOSANTS CRITIQUES DE SECURITE. POUR MAINTENIR LE DEGRE DE SECURITE DE L'APPAREIL, NE REMPLACER QUE DES PIECES RECOMMANDEES PAR LE FABRICANT.

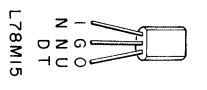

03

TUNER PCB

TO POWER AMP PCB

* INDICATED VOLTAGES ARE MEASURED AT FM(STEREO) TUNED MODE.

— (B (POWER SUPPLY) PCB

— SIGNAL LINE

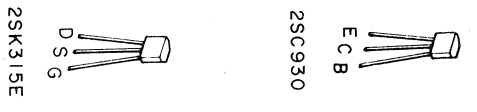
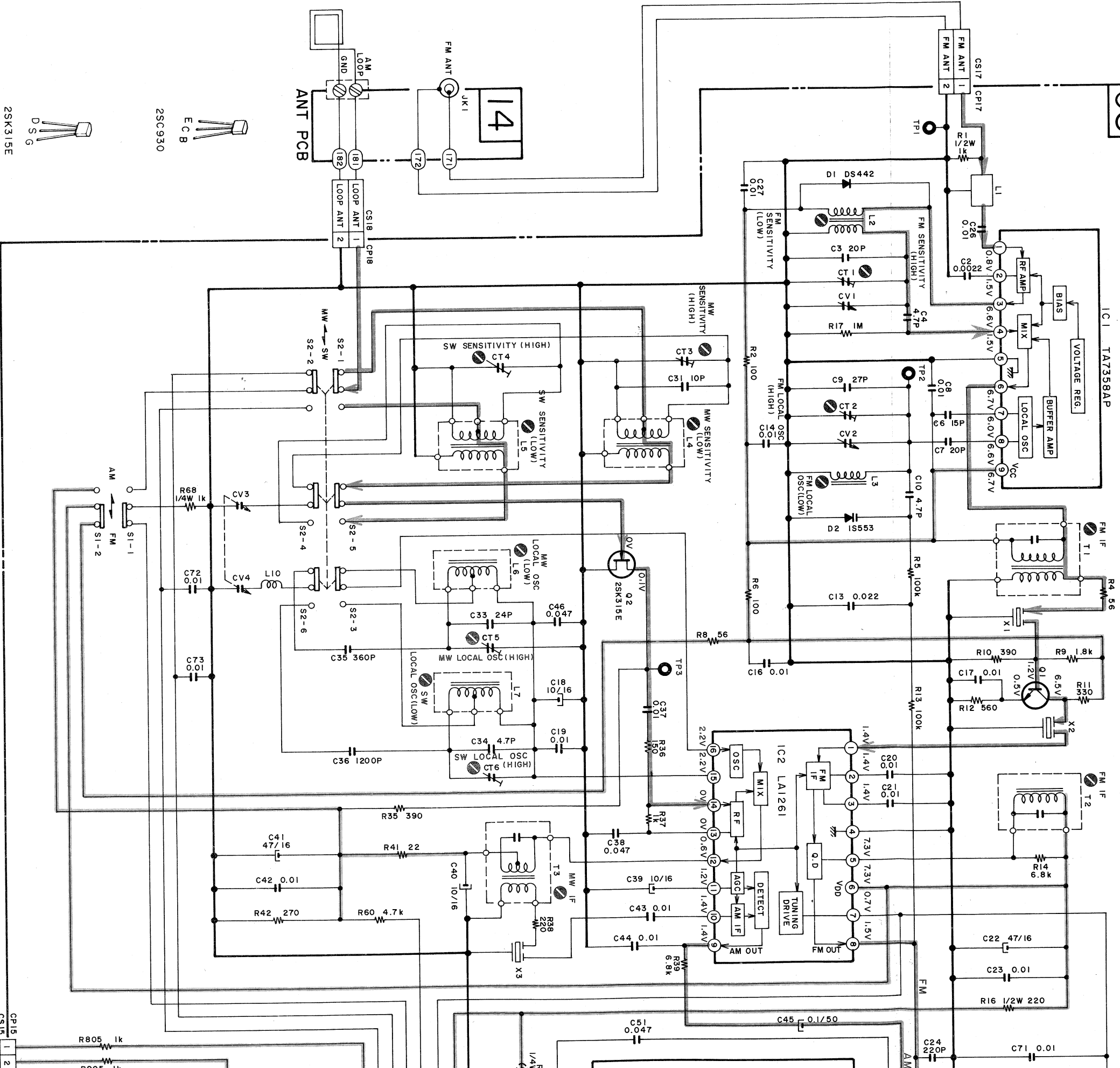

A B C D E F

1 2 3 4 5 6 7 8

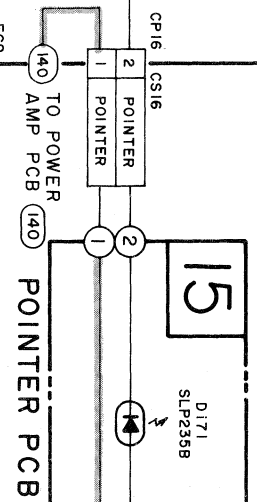
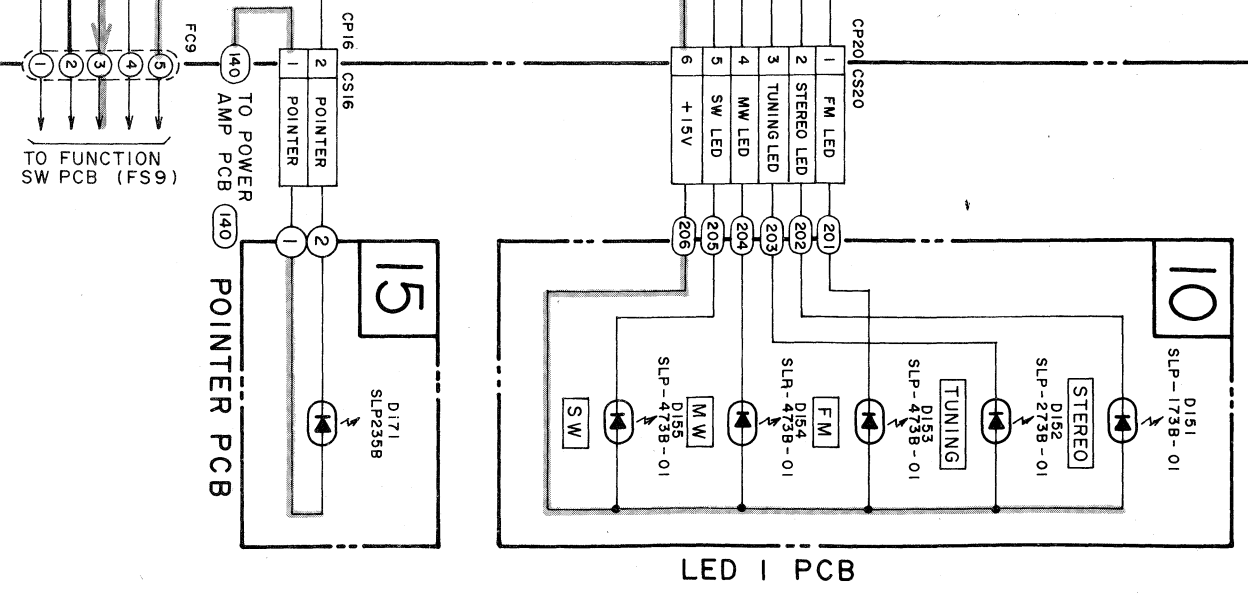
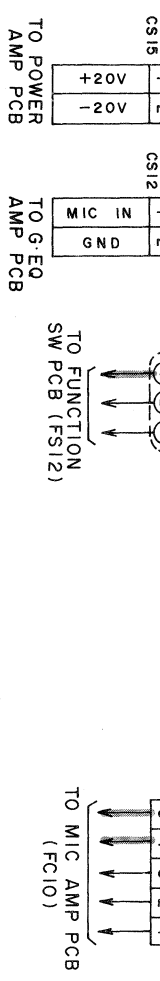
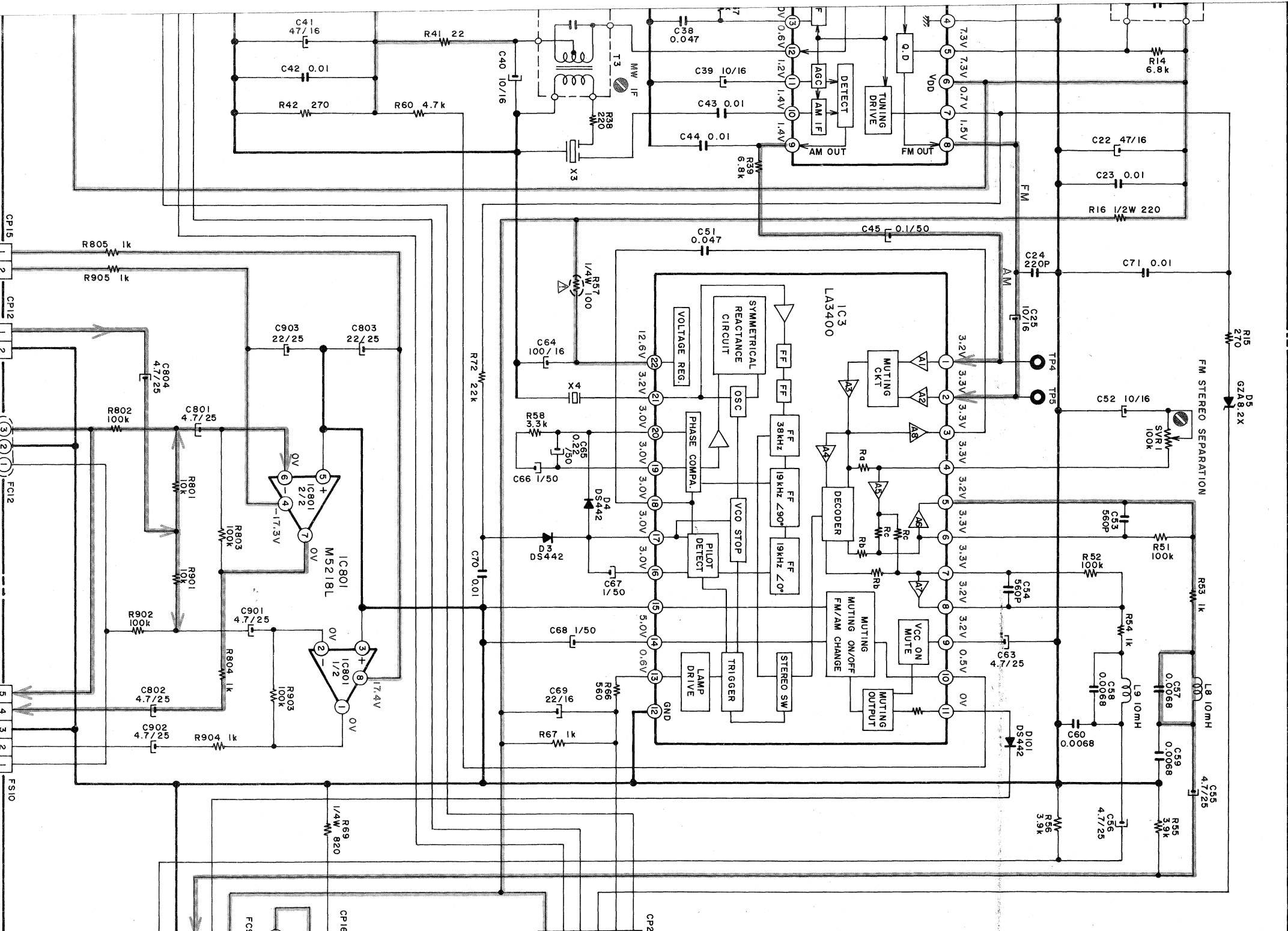

NOTE
UNLESS OTHERWISE SPECIFIED
ALL RESISTORS IN OHMS 1/5W (J)
ALL CAPACITORS IN µF

WARNING: INDICATES SAFETY CRITICAL COMPONENTS FOR CONTINUED SAFETY.
REPLACE SHEET CRITICAL COMPONENTS ONLY WITH MANUFACTURER'S
RECOMMENDED PARTS.
AVERTISSEMENT: AIL INDIQUE LES COMPOSANTS CRITIQUES DE SÉCURITÉ.
POUR MAINTENIR LE DEGRÉ DE SÉCURITÉ DE L'APPAREIL,
NE REMPLACEZ QUE DES PIÈCES RECOMMANDÉES PAR LE FABRICANT

AA-M8S TUNER SCHEMATIC DIAGRAM NO. 3-2 850402A

F G H I J K

F G H I J K

ADJUSTING PARTS FOR AA-M8S

T3	MW	IF
L6	MW	LOCAL OSC (Low)
CT5	MW	LOCAL OSC (High)
L4	MW	SENSITIVITY (Low)
CT3	MW	SENSITIVITY (High)
L7	SW	LOCAL OSC (Low)
CT6	SW	LOCAL OSC (High)
L5	SW	SENSITIVITY (Low)
CT4	SW	SENSITIVITY (High)
T1,T2	FM	IM
L3	FM	LOCAL OSC (Low)
CT2	FM	LOCAL OSC (High)
L2	FM	SENSITIVITY (Low)
CT1	FM	SENSITIVITY (High)
SVR	FM	SEPARATION

ADJUSTING PARTS FOR AA-M8L

T3	MW	IF
L6	MW	LOCAL OSC (Low)
CT5	MW	LOCAL OSC (High)
L4	MW	SENSITIVITY (Low)
CT3	MW	SENSITIVITY (High)
L7	LW	LOCAL OSC (Low)
CT6	LW	LOCAL OSC (High)
L5	LW	SENSITIVITY (Low)
CT4	LW	SENSITIVITY (High)
T1,T2	FM	IF
L3	FM	LOCAL OSC (Low)
CT2	FM	LOCAL OSC (High)
L2	FM	SENSITIVITY (Low)
CT1	FM	SENSITIVITY (High)
SVR1	FM	SEPARATION

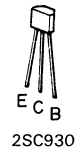

Q1 2SC930 (E)
Q2 2SK315E

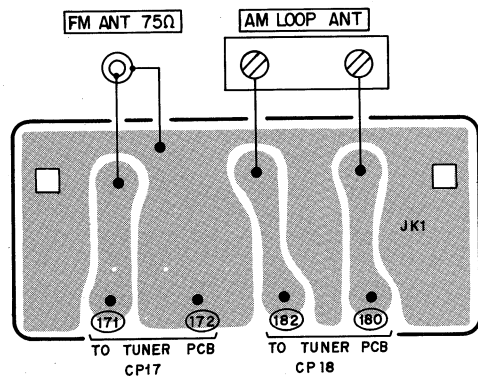

ANT TERMINAL PCB

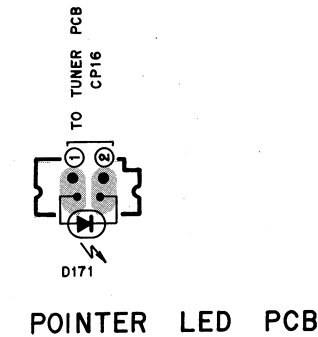
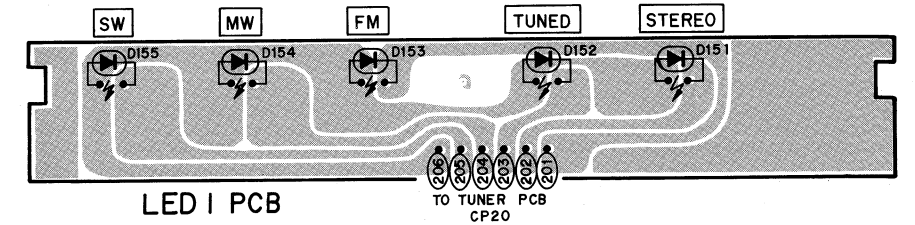
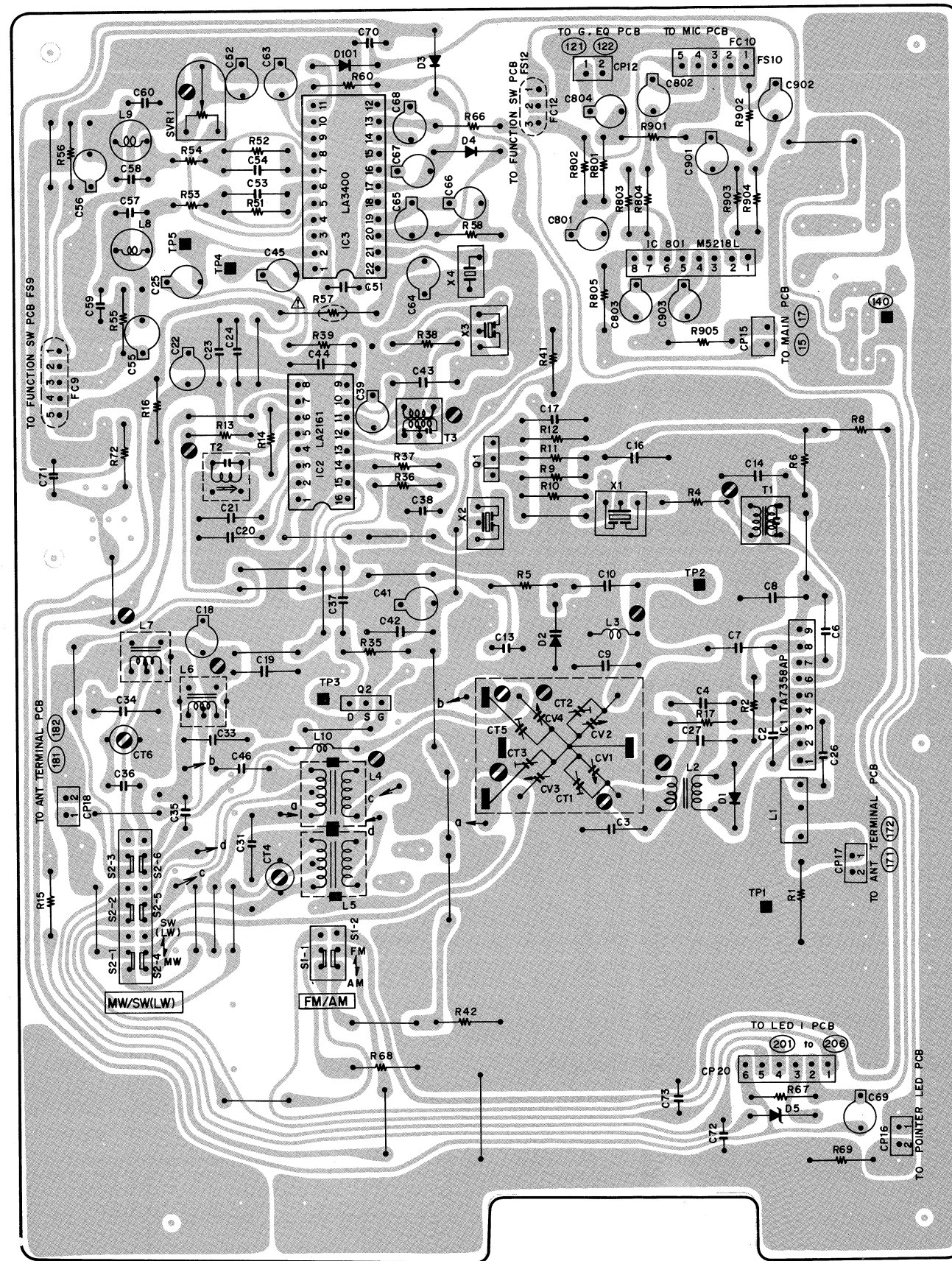

WARNING: ⚠ INDICATES SAFETY CRITICAL COMPONENTS FOR CONTINUED SAFETY. REPLACE SAFETY CRITICAL COMPONENTS ONLY WITH MANUFACTURER'S RECOMMENDED PARTS.

AVERTISSEMENT: ⚠ IL INDIQUE LES COMPOSANTS CRITIQUES DE SÉCURITÉ. POUR MAINTENIR LE DEGRÉ DE SÉCURITÉ DE L'APPAREIL, NE REMPLACER QUE DES PIÈCES RECOMMANDÉES PAR LE FABRICANT.

AA - A8L

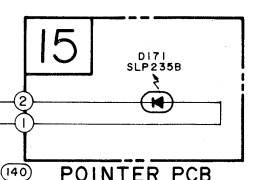
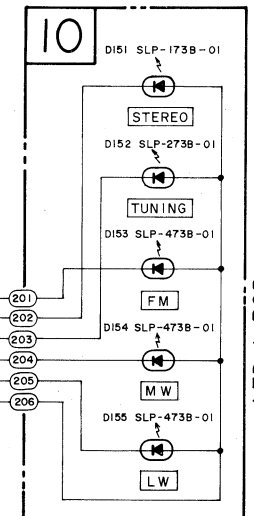
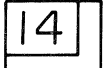
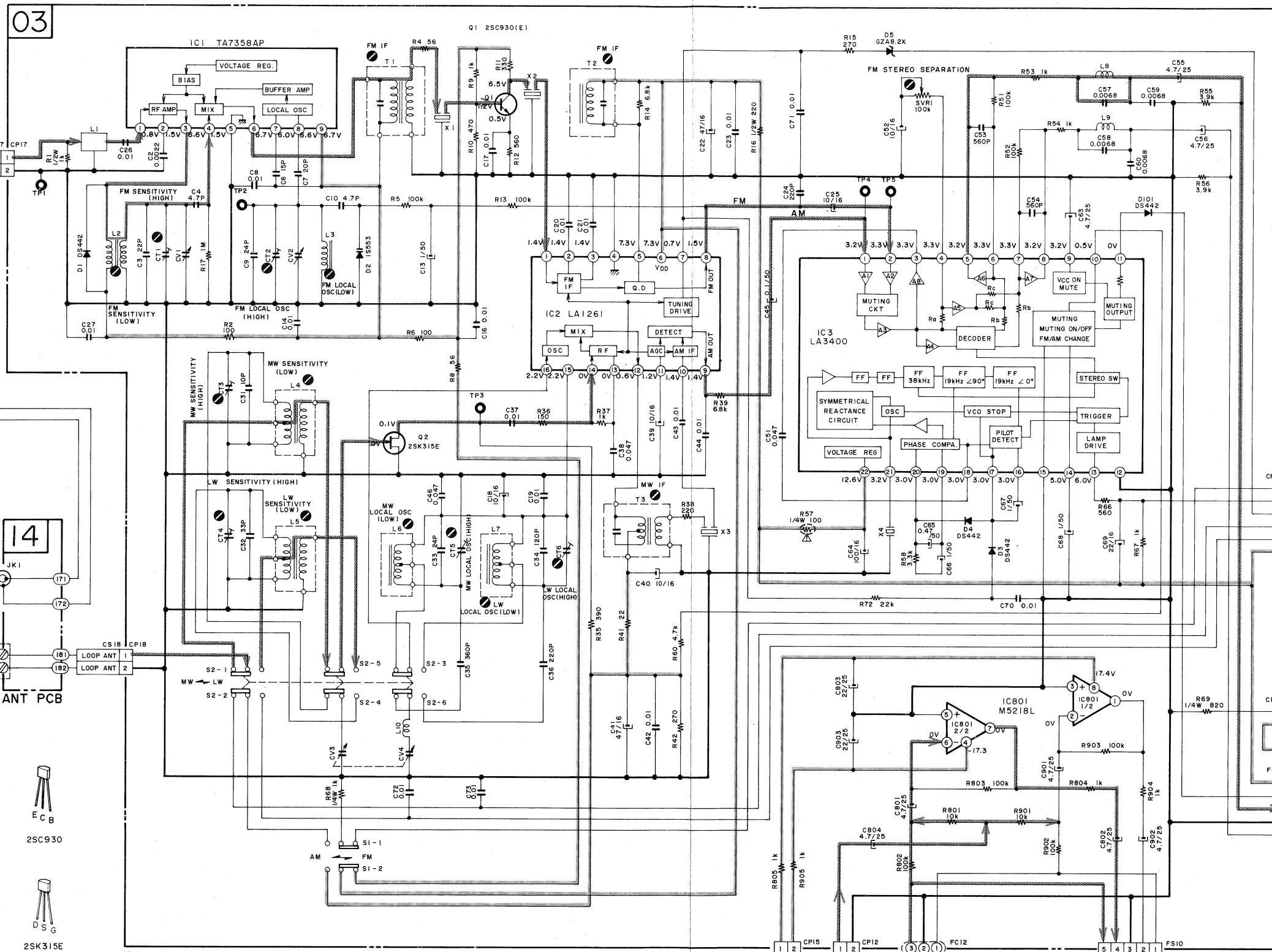

* INDICATED VOLTAGES ARE MESURED AT FM(STEREO) TUNED MODE.

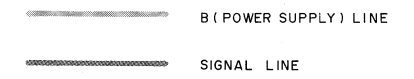

WARNING: Δ INDICATES SAFETY CRITICAL COMPONENTS FOR CONTINUED SAFETY. REPLACE SAFETY CRITICAL COMPONENTS ONLY WITH MANUFACTURER'S RECOMMENDED PARTS.
 AVERTISSEMENT: Δ IL INDIQUE LES COMPOSANTS CRITIQUES DE SÉCURITÉ. POUR MAINTENIR LE DEGRÉ DE SÉCURITÉ DE L'APPAREIL, NE REMPLACER QUE DES PIÈCES RECOMMANDÉES PAR LE FABRICANT

NOTE: UNLESS OTHERWISE SPECIFIED, ALL RESISTORS IN OHMS 1/6W (J), ALL CAPACITORS IN μ F.
AA-M8L TUNER SCHEMATIC DIAGRAM
 NO. 3-3 850403A

ADJUSTING PARTS FOR AA-M8S

T3.....	MW	IF
L6.....	MW	LOCAL OSC (Low)
CT5.....	MW	LOCAL OSC (High)
L4.....	MW	SENSITIVITY (Low)
CT3.....	MW	SENSITIVITY (High)
L7.....	SW	LOCAL OSC (Low)
CT6.....	SW	LOCAL OSC (High)
L5.....	SW	SENSITIVITY (Low)
CT4.....	SW	SENSITIVITY (High)
T1,T2.....	FM	IM
L3.....	FM	LOCAL OSC (Low)
CT2.....	FM	LOCAL OSC (High)
L2.....	FM	SENSITIVITY (Low)
CT1.....	FM	SENSITIVITY (High)
SVR.....	FM	SEPARATION

ADJUSTING PARTS FOR AA-M8L

T3.....	MW	IF
L6.....	MW	LOCAL OSC (Low)
CT5.....	MW	LOCAL OSC (High)
L4.....	MW	SENSITIVITY (Low)
CT3.....	MW	SENSITIVITY (High)
L7.....	LW	LOCAL OSC (Low)
CT6.....	LW	LOCAL OSC (High)
L5.....	LW	SENSITIVITY (Low)
CT4.....	LW	SENSITIVITY (High)
T1,T2.....	FM	IF
L3.....	FM	LOCAL OSC (Low)
CT2.....	FM	LOCAL OSC (High)
L2.....	FM	SENSITIVITY (Low)
CT1.....	FM	SENSITIVITY (High)
SVR1.....	FM	SEPARATION



2SK315E



2SC930

- Q1.....2SC930 (E)
- Q2.....2SK315E

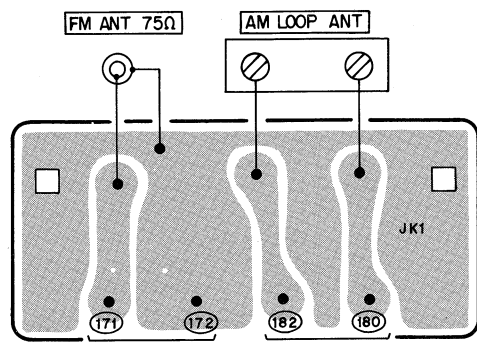

ANT TERMINAL PCB

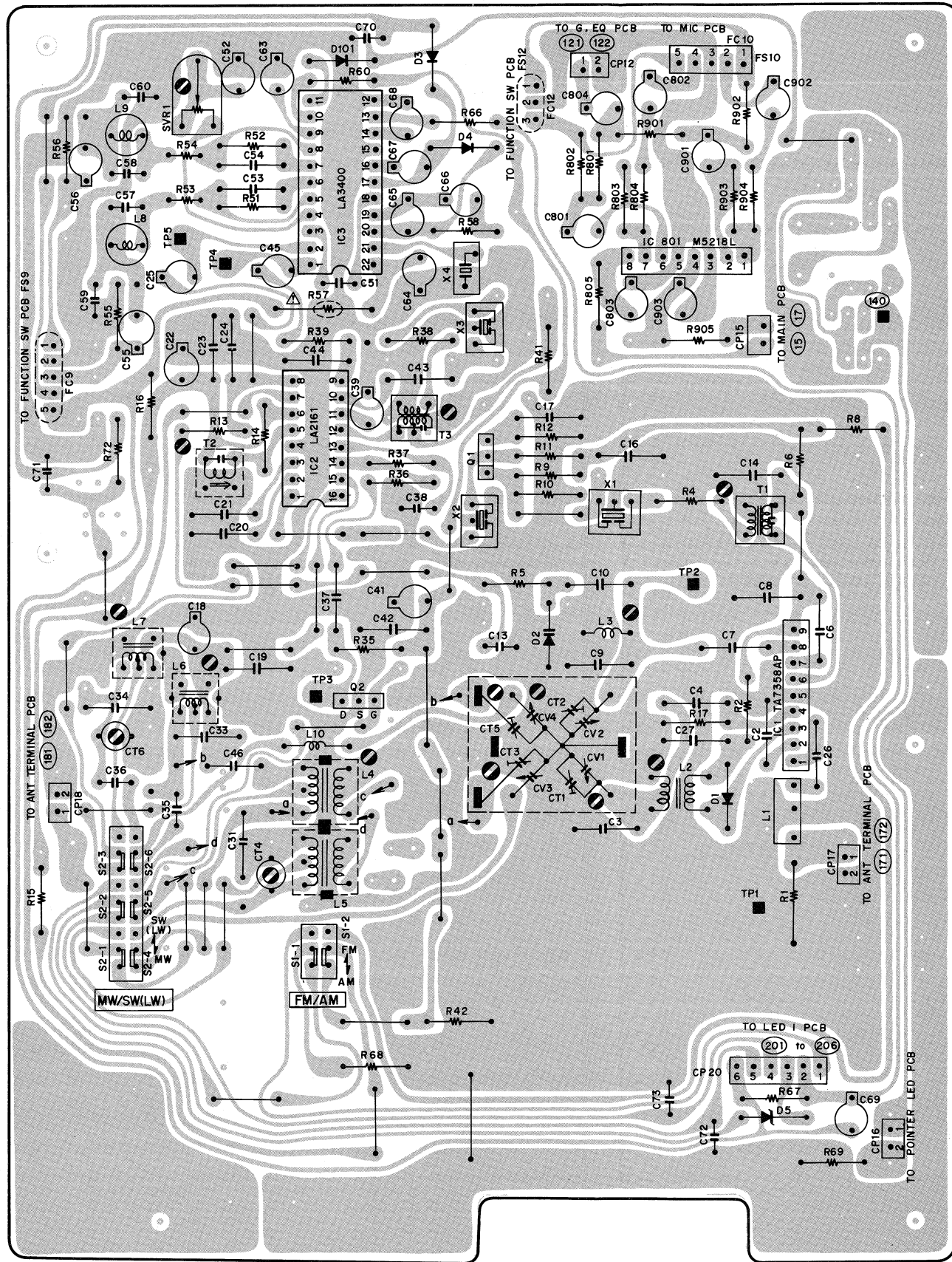

TUNER PCB

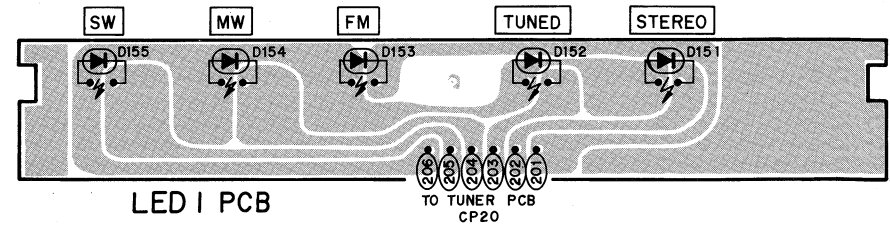

LED I PCB

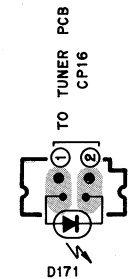

POINTER LED PCB

WARNING: ⚠ INDICATES SAFETY CRITICAL COMPONENTS. FOR CONTINUED SAFETY, REPLACE SAFETY CRITICAL COMPONENTS ONLY WITH MANUFACTURER'S RECOMMENDED PARTS.
 AVERTISSEMENT: ⚠ IL INDIQUE LES COMPOSANTS CRITIQUES DE SÉCURITÉ. POUR MAINTENIR LE DEGRÉ DE SÉCURITÉ DE L'APPAREIL, NE REMPLACER QUE DES PIÈCES RECOMMANDÉES PAR LE FABRICANT.

AA-M8S/L

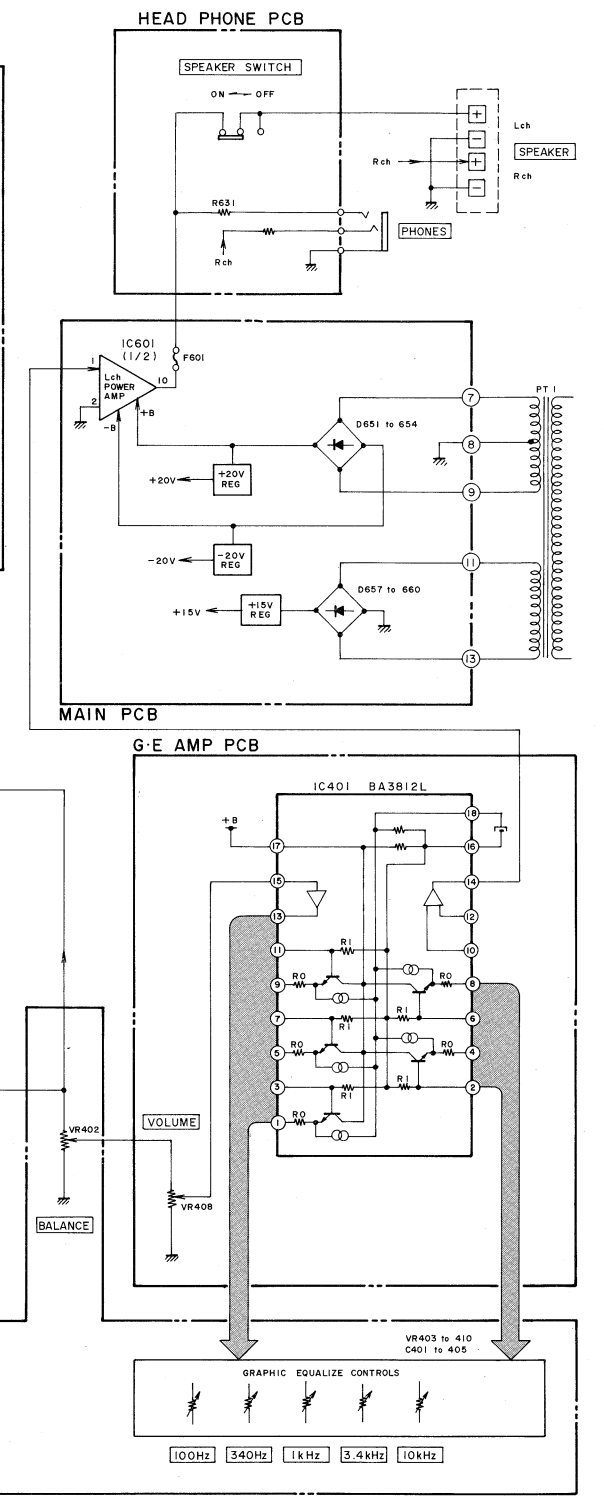
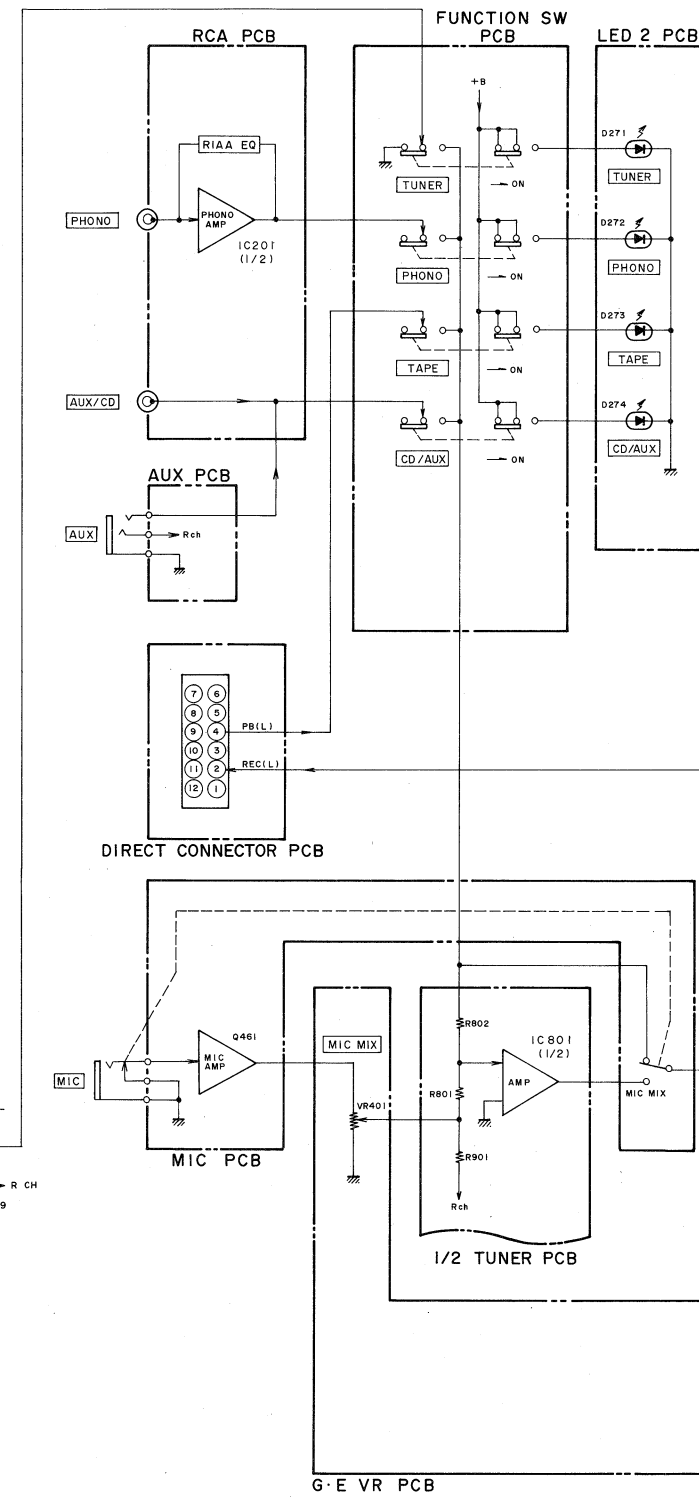
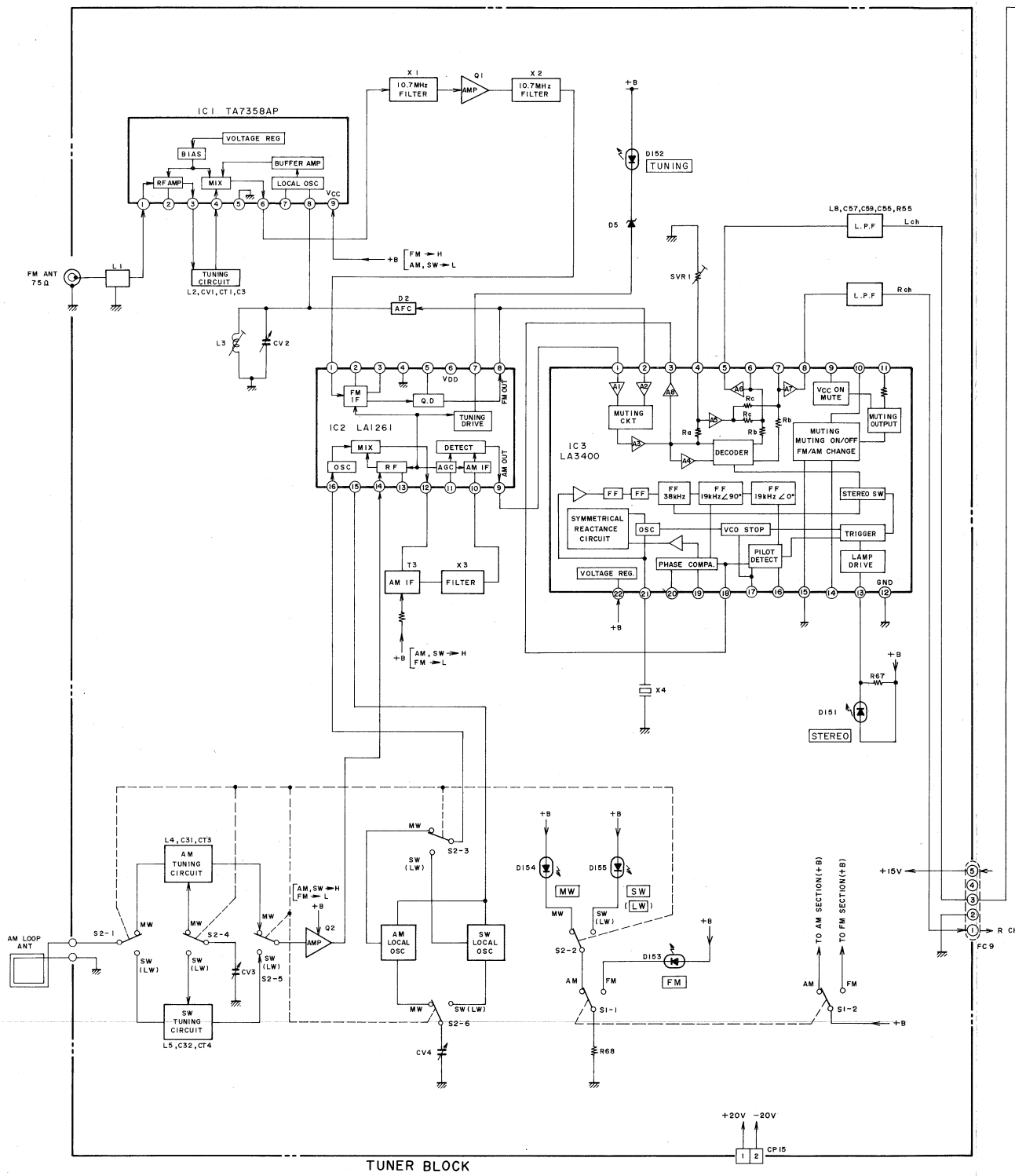

* THIS BLOCK DIAGRAM IS INDICATED LEFT CHANNEL ONLY.

AA-M8S/L
BLOCK DIAGRAM
No. 850404A