

AM-A3

AKAI SERVICE MANUAL

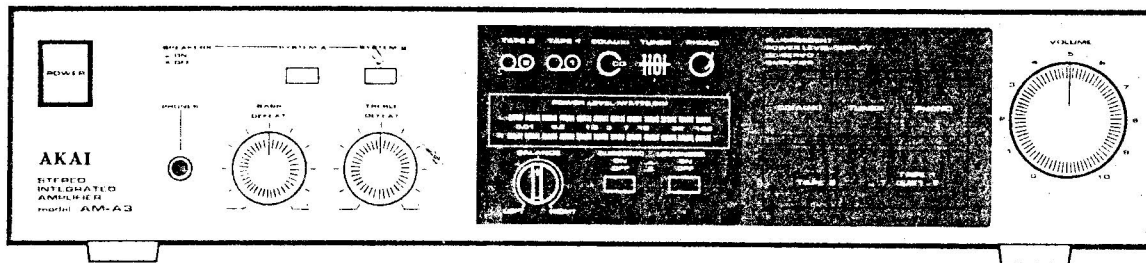

STEREO INTEGRATED AMPLIFIER

MODEL **AM-A3**

AKAI

MODEL AM-A3

SCHEMATIC DIAGRAM AND PC BOARD

1. SCHEMATIC DIAGRAM OF ICs 1
2. BLOCK DIAGRAM 1
3. SCHEMATIC DIAGRAM 2
4. MAIN-AMP PC BOARD, POWER SUPPLY PC BOARD 3
5. BALANCE PC BOARD, EQUALIZER PC BOARD, FILTER PC BOARD, HEADPHONE PC BOARD, LED (1) PC BOARD, MAIN VR PC BOARD, METER PC BOARD, SPEAKER SW PC BOARD, SPEAKER TERMINAL PC BOARD, TAPE PC BOARD 4

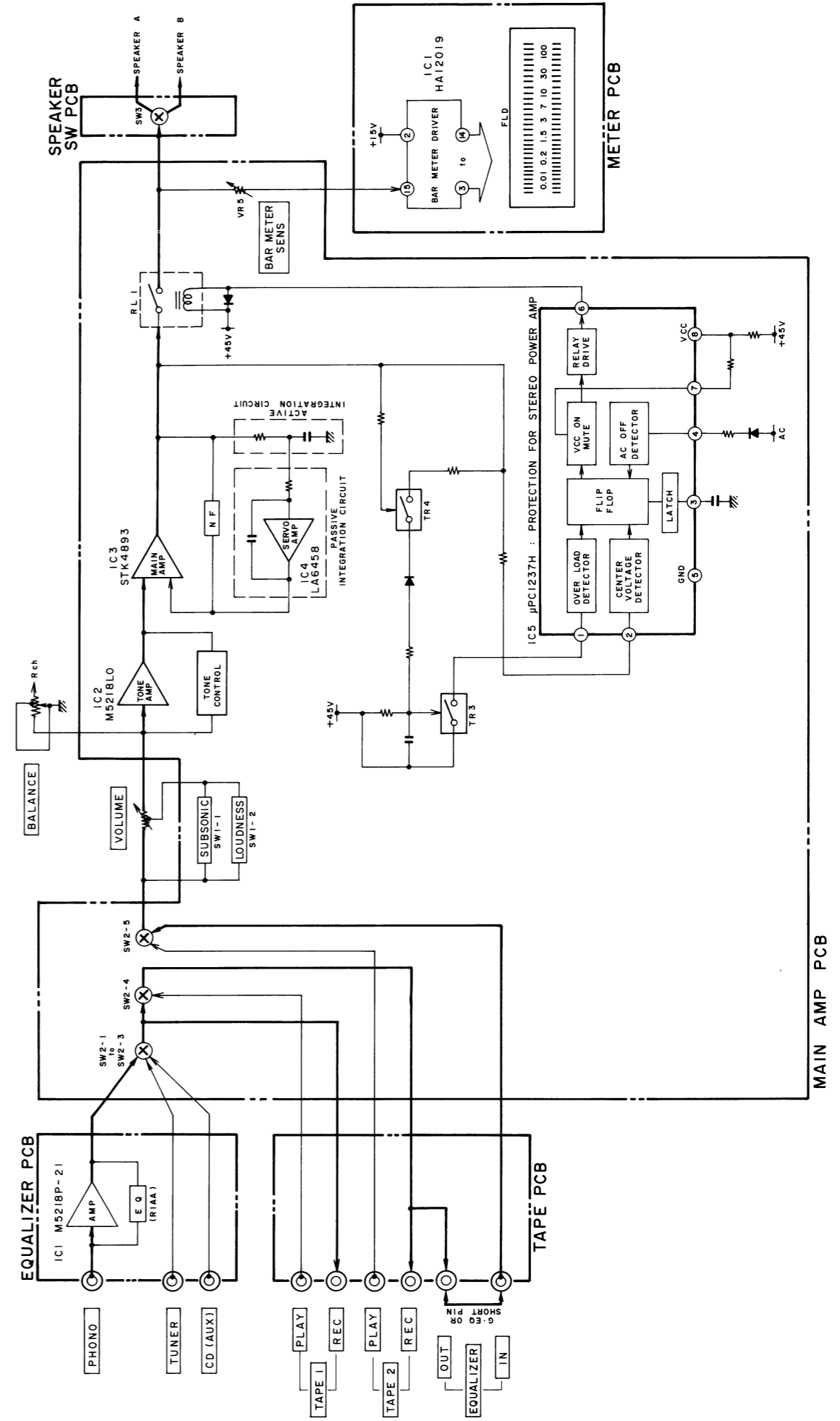
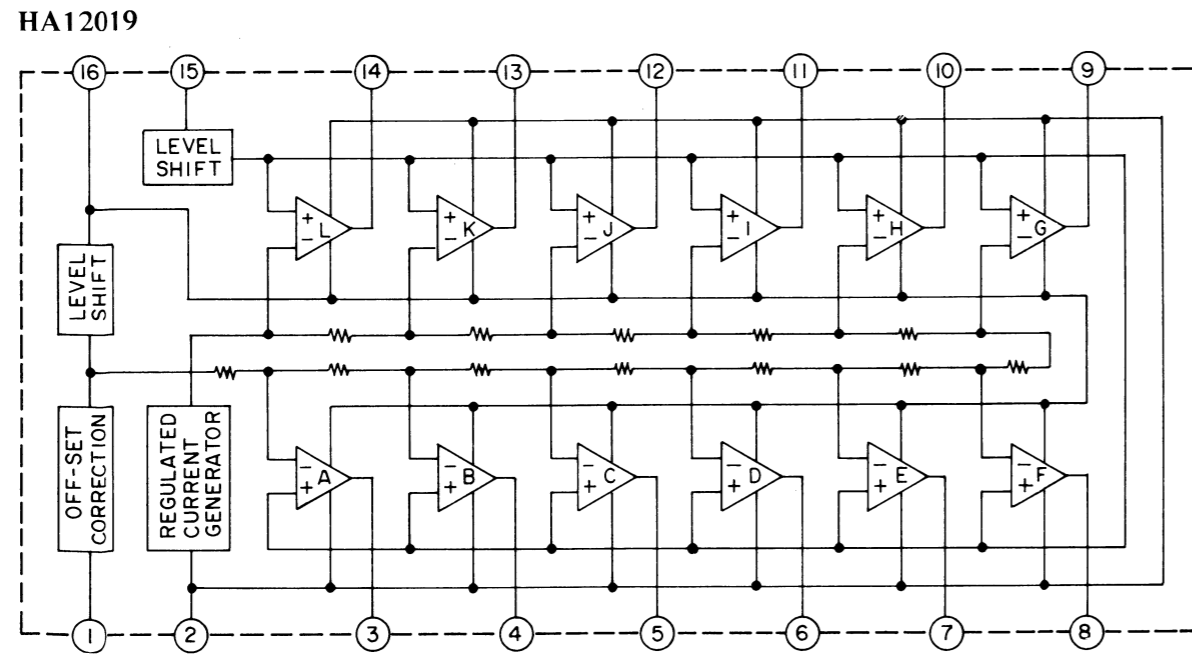

AM-A3
BLOCK DIAGRAM
No. 840823A (A2)

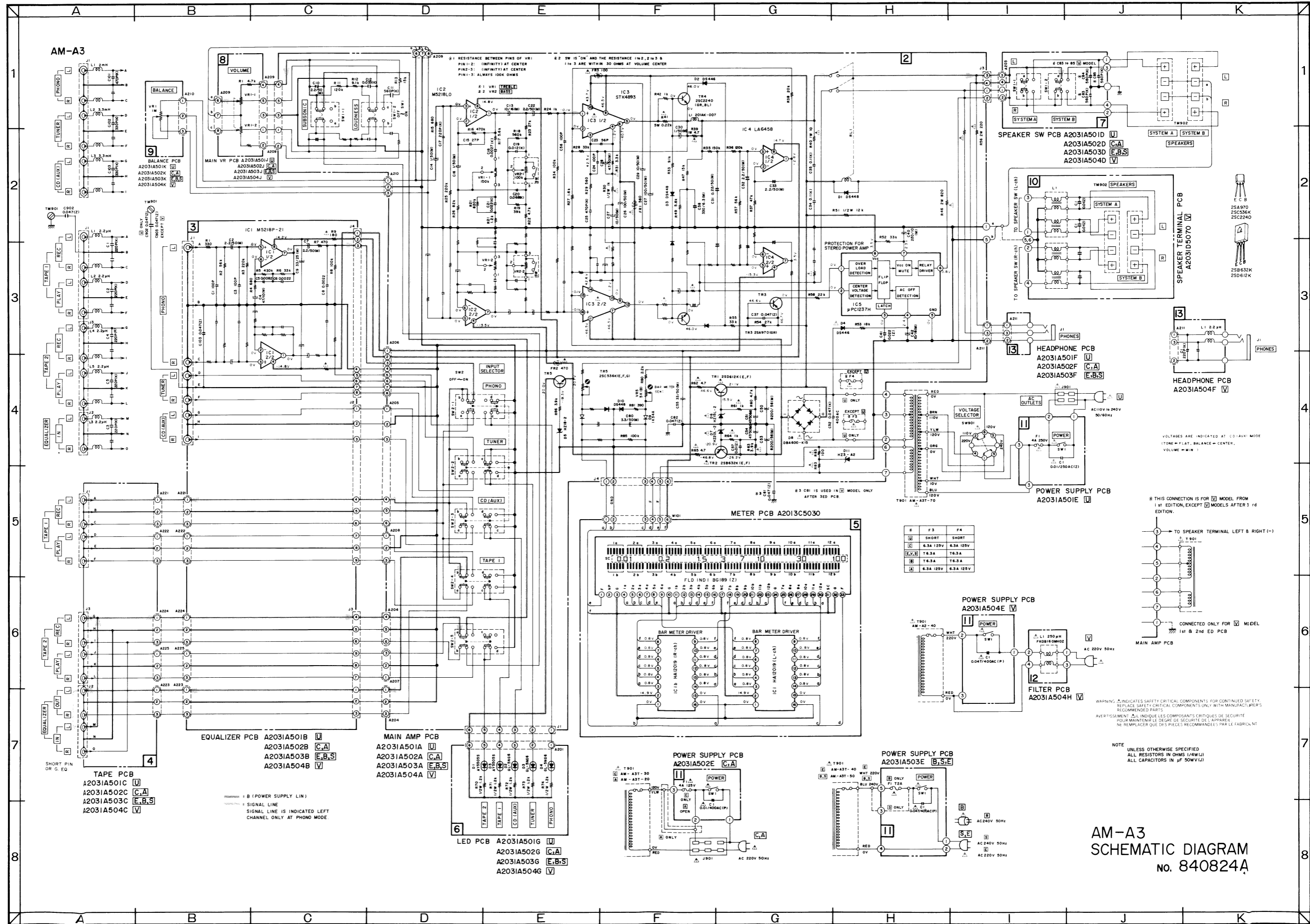

AM-A3

TAPE PCB
 A2031A501C [U]
 A2031A502C [C,A]
 A2031A503C [E,B,S]
 A2031A504C [V]

EQUALIZER PCB
 A2031A501B [U]
 A2031A502B [C,A]
 A2031A503B [E,B,S]
 A2031A504B [V]

MAIN AMP PCB
 A2031A501A [U]
 A2031A502A [C,A]
 A2031A503A [E,B,S]
 A2031A504A [V]

LED PCB
 A2031A501G [U]
 A2031A502G [C,A]
 A2031A503G [E,B,S]
 A2031A504G [V]

POWER SUPPLY PCB
 A2031A502E [C,A]

POWER SUPPLY PCB
 A2031A503E [E,B,S]

POWER SUPPLY PCB
 A2031A504E [V]

FILTER PCB
 A2031A504H [V]

METER PCB
 A2013C5030

POWER SUPPLY PCB
 A2031A501E [U]

HEADPHONE PCB
 A2031A501F [U]
 A2031A502F [C,A]
 A2031A503F [E,B,S]

HEADPHONE PCB
 A2031A504F [V]

SPEAKER SW PCB
 A2031A501D [U]
 A2031A502D [C,A]
 A2031A503D [E,B,S]
 A2031A504D [V]

SPEAKER TERMINAL PCB
 A2031D5070 [V]

R	F3	F4
[U]	SHORT	SHORT
[C]	6.3A 125V	6.3A 125V
[E,B,S]	T6.3A	T6.3A
[V]	T6.3A	T6.3A
[V]	6.3A 125V	6.3A 125V

* THIS CONNECTION IS FOR [U] MODEL FROM 1st EDITION, EXCEPT [V] MODELS AFTER 3rd EDITION.

CONNECTED ONLY FOR [U] MODEL 1st & 2nd ED PCB

WARNING: Δ INDICATES SAFETY CRITICAL COMPONENTS. FOR CONTINUED SAFETY, REPLACE SAFETY CRITICAL COMPONENTS ONLY WITH MANUFACTURER'S RECOMMENDED PARTS.
 AVERTISSEMENT: Δ INDIQUE LES COMPOSANTS CRITIQUES DE SECURITE. POUR MAINTENIR LE DEGRE DE SECURITE DES APPAREILS, NE REMPLACEZ QUE DES PIECES RECOMMANDEES PAR LE FABRICANT.

NOTE: UNLESS OTHERWISE SPECIFIED ALL RESISTORS IN OHMS 1/4W(1/2)
 ALL CAPACITORS IN μF 50V(50V)

AM-A3
SCHEMATIC DIAGRAM
 No. 840824A

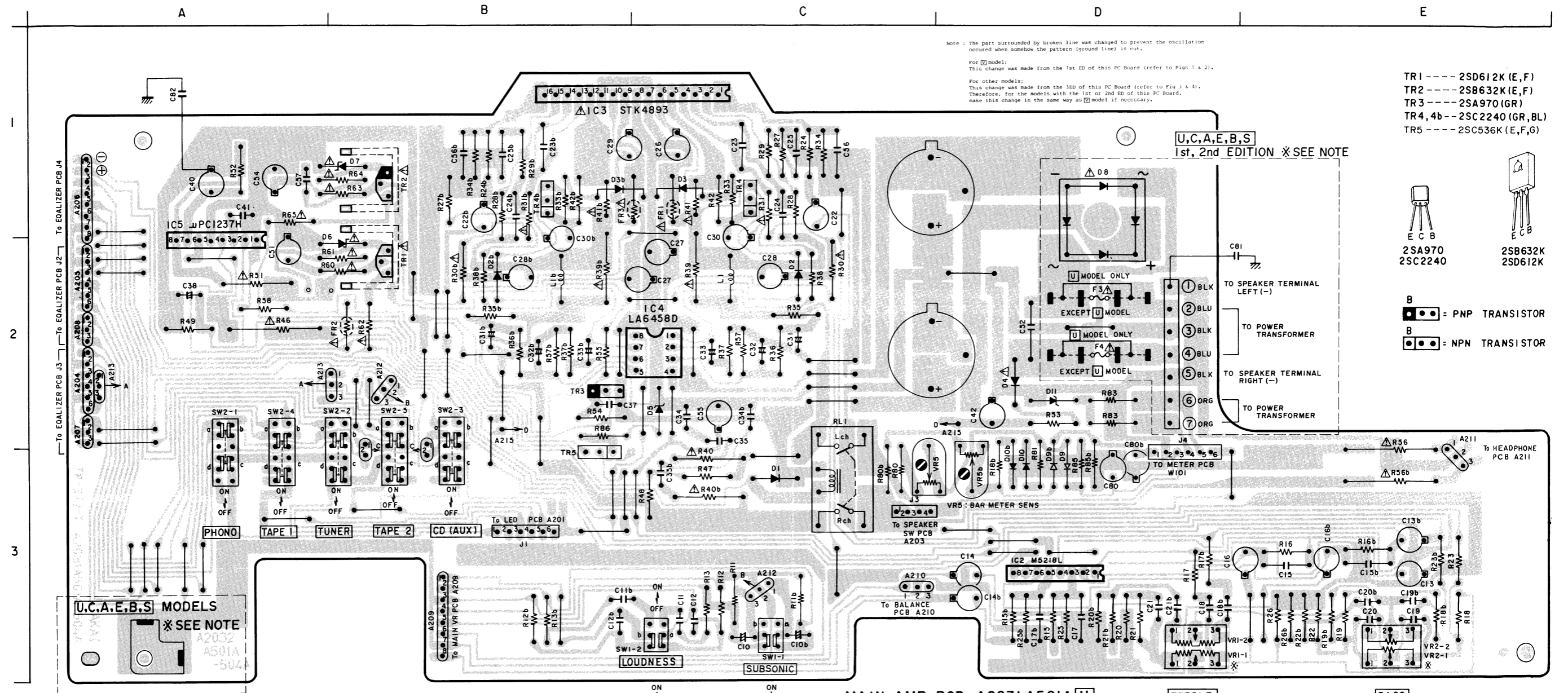

Note: The part surrounded by broken line was changed to prevent the oscillation occurred when somehow the pattern (ground line) is cut.
 For [U] model:
 This change was made from the 1st ED of this PC Board (refer to Figs 1 & 2).
 For other models:
 This change was made from the 3RD of this PC Board (refer to Fig 1 & 4).
 Therefore, for the models with the 1st or 2nd ED of this PC Board, make this change in the same way as [U] model if necessary.

- TR1 ---- 2SD612K (E,F)
- TR2 ---- 2SB632K (E,F)
- TR3 ---- 2SA970 (GR)
- TR4, 4b -- 2SC2240 (GR, BL)
- TR5 ---- 2SC536K (E,F,G)

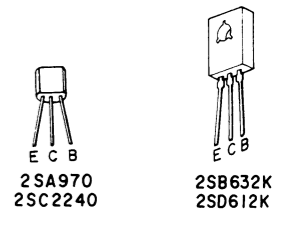

ECB
 2SA970
 2SC2240

ECB
 2SB632K
 2SD612K

B
 ● ● ● = PNP TRANSISTOR
 B
 ● ● ● = NPN TRANSISTOR

U,C,A,E,B,S
 1st, 2nd EDITION *SEE NOTE

- ① BLK TO SPEAKER TERMINAL LEFT (-)
- ② BLU TO POWER TRANSFORMER
- ③ BLK TO SPEAKER TERMINAL RIGHT (-)
- ④ BLU TO POWER TRANSFORMER
- ⑤ BLK TO SPEAKER TERMINAL RIGHT (-)
- ⑥ DRG TO POWER TRANSFORMER
- ⑦ DRG TO POWER TRANSFORMER

U.C.A.E.B,S MODELS
 *SEE NOTE
 A2032
 A501A
 -504

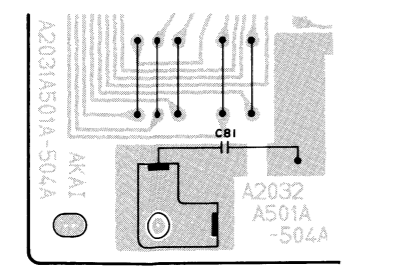

Fig.1 U.C.A.E.B,S MODELS A2032 A501A -504A

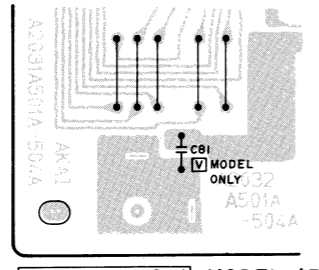
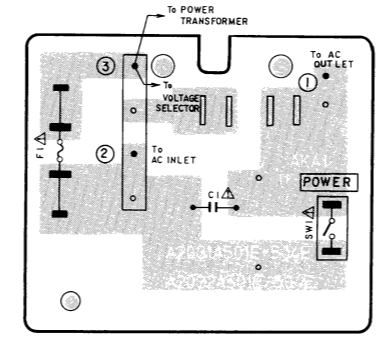

Fig.3 U.C.A.E.B,S,V MODEL (3ED)

LOCATION OF COMPONENTS

IC s	TR s	TERMINALS
IC2 ---- D3	TR1 ---- B2	J1 ---- B3
IC3 ---- B1,C1	TR2 ---- B1	J3 ---- C3
IC4 ---- C2	TR3 ---- B2	J4 ---- D3
IC5 ---- A1,A2	TR4 ---- C1	A204,205 --- A2
	TR4b ---- B1	A206 ---- A1
	TR5 ---- B3	A207,208 --- A2
		A209 ---- B3
		A210 ---- C3
		A211 ---- E3
		① to ⑦ --- D2

WARNING: Δ INDICATES SAFETY CRITICAL COMPONENTS. FOR CONTINUED SAFETY, REPLACE SAFETY CRITICAL COMPONENTS ONLY WITH MANUFACTURER'S RECOMMENDED PARTS.
 AVERTISSEMENT: Δ IL INDIQUE LES COMPOSANTS CRITIQUES DE SÉCURITÉ. POUR MAINTENIR LE DEGRÉ DE SÉCURITÉ DE L'APPAREIL, NE REMPLACER QUE DES PIÈCES RECOMMANDÉES PAR LE FABRICANT.



POWER SUPPLY PCB A2031A501E [U]

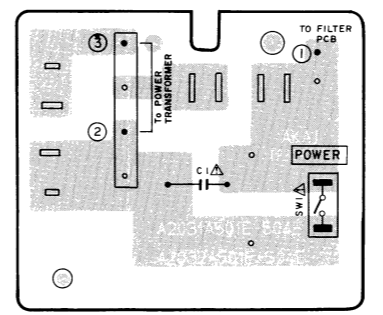

POWER SUPPLY PCB A2031A504E [V]

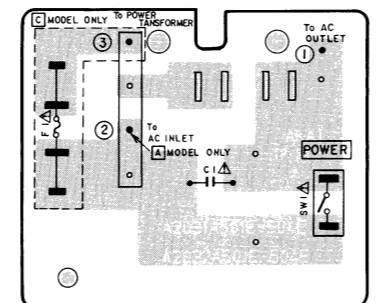

POWER SUPPLY PCB A2031A502E [C,A]

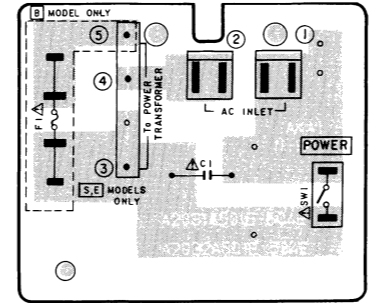

POWER SUPPLY PCB A2031A503E [E,B,S]

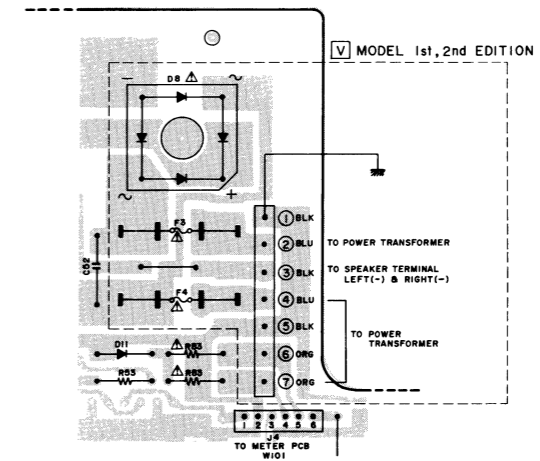

Fig.2

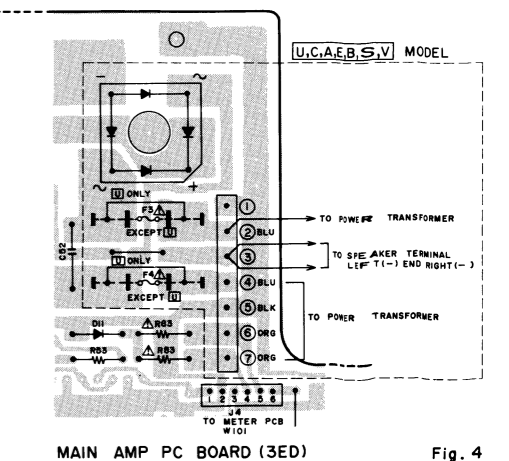
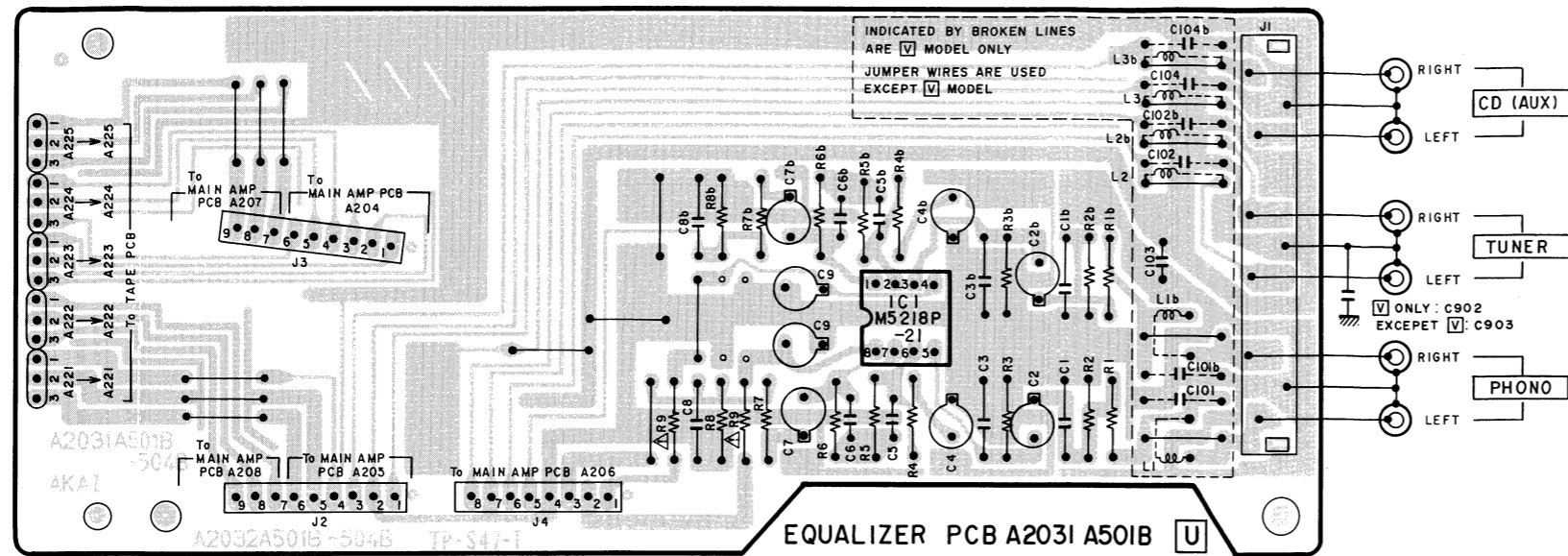

Fig.4



EQUALIZER PCB A2031A501B

- 502B [C,A]
- 503B [E,B,S]
- 504B [V]

WARNING: Δ INDICATES SAFETY CRITICAL COMPONENTS. FOR CONTINUED SAFETY, REPLACE SAFETY CRITICAL COMPONENTS ONLY WITH MANUFACTURER'S RECOMMENDED PARTS.
 AVERTISSEMENT: Δ IL INDIQUE LES COMPOSANTS CRITIQUES DE SÉCURITÉ. POUR MAINTENIR LE DEGRÉ DE SÉCURITÉ DE L'APPAREIL, NE REMPLACER QUE DES PIÈCES RECOMMANDÉES PAR LE FABRICANT.

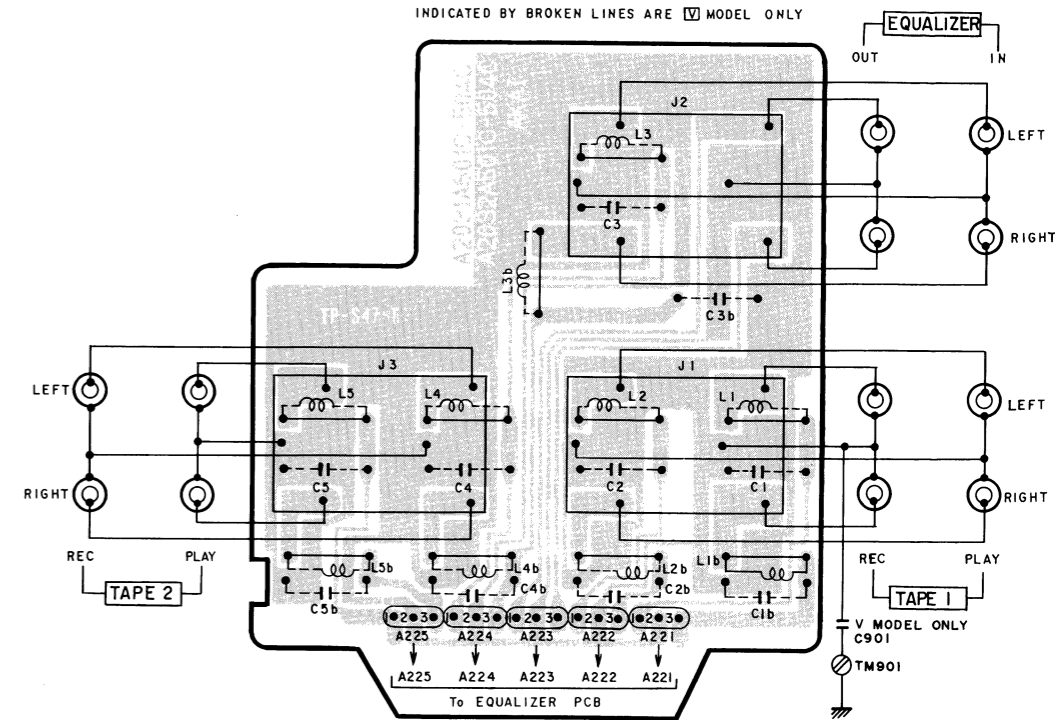

TAPE PCB A2031A501C

- 502C [C,A]
- 503C [E,V,S]
- 504C [V]

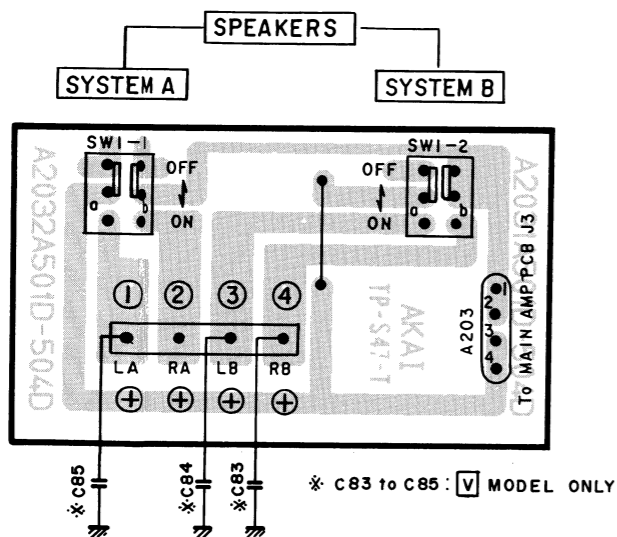

SPEAKER SW PCB A2031A501D

- 502D [C,A]
- 503D [E,B,S]
- 504D [V]

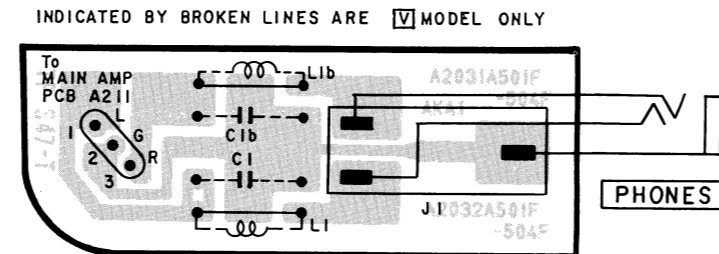

HEADPHONE PCB A2031A501F

- 502F [C,A]
- 503F [E,B,S]
- 504F [V]

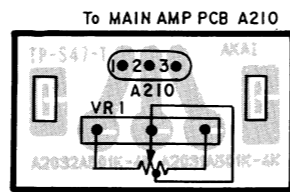

BALANCE PCB A2031A501K

- 502K [C,A]
- 503K [E,B,S]
- 504K [V]

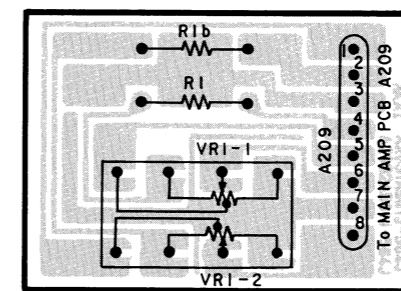

MAIN VR PCB A2031A501J

- 502J [C,A]
- 503J [E,B,S]
- 504J [V]

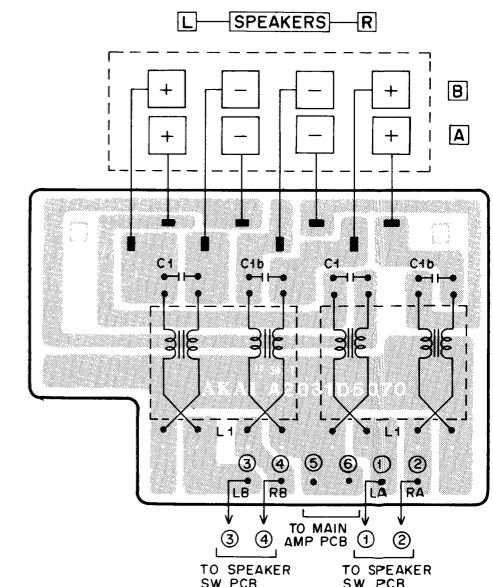

SPEAKER TERMINAL PCB A2031D5070

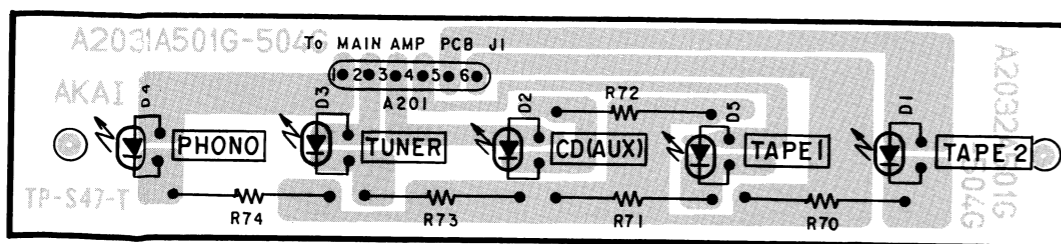

LED PCB A2031A501G

- 502G [C,A]
- 503G [E,B,S]
- 504G [V]

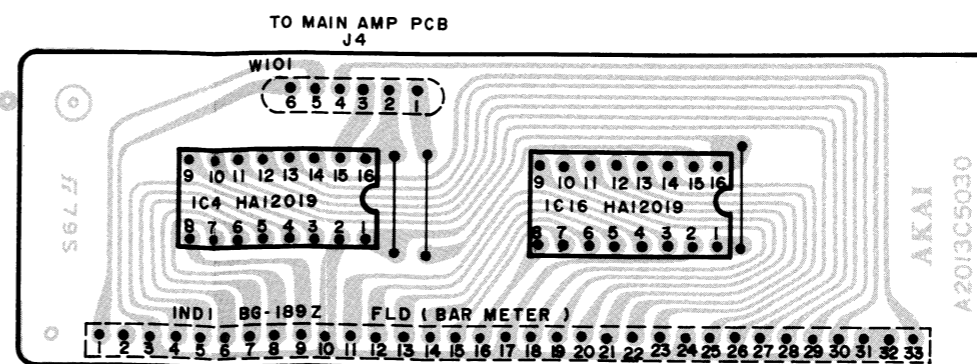

METER PCB A2013C5030

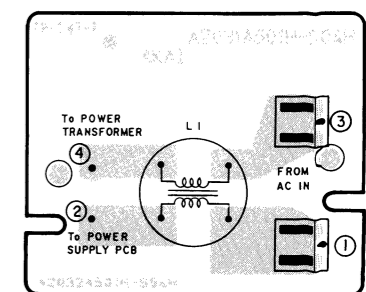

FILTER PCB A2031A504H

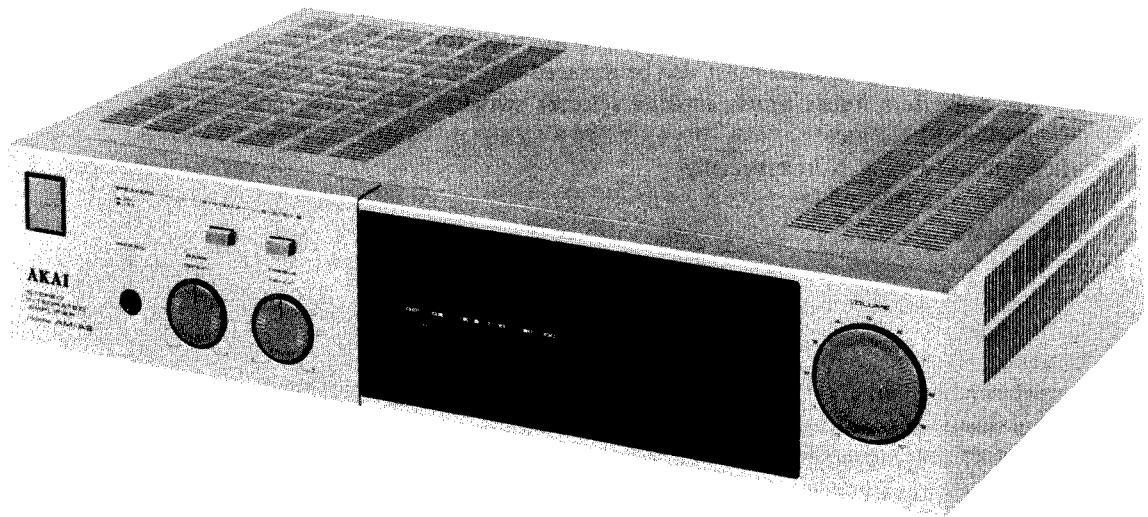

STEREO INTEGRATED AMPLIFIER
MODEL AM-A3

SECTION 1	SERVICE MANUAL	3
SECTION 2	PARTS LIST	11

SAFETY INSTRUCTIONS

SAFETY CHECK AFTER SERVICING

Confirm the specified insulation resistance between power cord plug prongs and externally exposed parts of the set is greater than 10 Mohms, but for equipment with external antenna terminals (tuner, receiver, etc.) and is intended for **C** or **A**, specified insulation resistance should be more than 2.2 Mohms (ground terminals, microphone jacks, headphone jacks, line-in-out jacks etc.)

PRECAUTIONS DURING SERVICING

1. Parts identified by the Δ symbol parts are critical for safety.
Replace only with parts number specified.
2. In addition to safety, other parts and assemblies are specified for conformance with such regulations as those applying to spurious radiation. These must also be replaced only with specified replacements.
Examples: RF converters, tuner units, antenna selector switches, RF cables, noise blocking capacitors, noise blocking filters, etc.
3. Use specified internal wiring. Note especially:
 - 1) Wires covered with PVC tubing
 - 2) Double insulated wires
 - 3) High voltage leads
4. Use specified insulating materials for hazardous live parts. Note especially:
 - 1) Insulation Tape
 - 2) PVC tubing
 - 3) Spacers (Insulating Barriers)
 - 4) Insulation sheets for transistors
 - 5) Plastic screws for fixing microswitch (especially in turntable)
5. When replacing AC primary side components (transformers, power cords, noise blocking capacitors, etc.), wrap ends of wires securely about the terminals before soldering.

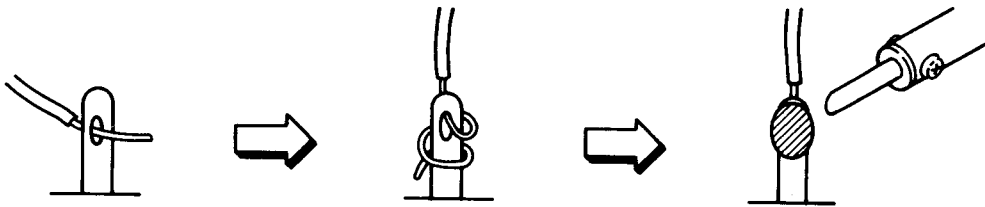

6. Observe that wires do not contact heat producing parts (heatsinks, oxide metal film resistors, fusible resistors, etc.).
7. Check that replaced wires do not contact sharp edged or pointed parts.
8. Also check areas surrounding repaired locations.
9. Use care that foreign objects (screws, solder droplets, etc.) do not remain inside the set.

VOLTAGE CONVERSION

Models for Canada, USA, Europe, UK and Australia are not equipped with this facility. Each machine is preset at the factory according to destination, but some machines can be set to 110V, 120V, 220V, or 240V as required. If your machine's voltage can be converted:

Before connecting the power cord, turn the VOLTAGE SELECTOR located on the rear panel with a screwdriver until the correct voltage is indicated.

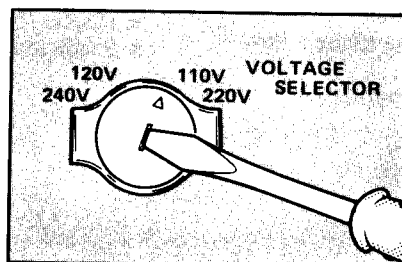

SECTION 1

SERVICE MANUAL

TABLE OF CONTENTS

I. SPECIFICATIONS	4
II. DISMANTLING OF UNIT	5
III. CONTROLS	6
IV. PRINCIPAL PARTS LOCATION	7
V. AMPLIFIER SECTION ADJUSTMENT	8
1. THE INSTRUMENT CONNECTION	8
2. MAIN AMP PC BOARD ADJUSTMENT POINTS	8
3. BAR (POWER LEVEL) METER ADJUSTMENT	8
VI. PC BOARD TITLE AND IDENTIFICATIONS	9

For basic adjustments, measuring methods, and operating principles, refer to GENERAL TECHNICAL MANUAL.

I . SPECIFICATIONS

POWER AMPLIFIER SECTION

RATED POWER OUTPUT 20Hz to 20kHz	8 ohms 45W/0.05%	4 ohms 45W/0.08%
POWER OUTPUT (BY FTC) 20Hz to 20kHz 1kHz	8 ohms 50W/0.05% 52W/0.05%	4 ohms 52W/0.08% 53W/0.08%
MUSIC POWER (BOTH CHANNEL)	240W	
POWER BANDWIDTH (IHF -3dB, 8ohms)	5Hz to 60kHz (0.2%)	
S/N (IHF-A) PHONO CD (AUX)	72dB 95dB	
RESIDUAL NOISE (8ohms)	0.5mV	
CHANNEL SEPARATION (IHF, 1kHz)	55dB	
DAMPING FACTOR (1kHz, 8ohms)	50	
REQUIRED SPEAKER IMPEDANCE	A or B : 4 to 16 ohms A + B : 8 to 16 ohms	

PRE AMPLIFIER SECTION

INPUT SENSITIVITY/IMPEDANCE PHONO CD (AUX) TAPE	2mV/47kohms 150mV/47kohms 150mV/47kohms
OUTPUT LEVEL/IMPEDANCE TAPE REC	150mV/1kohms
FREQUENCY RESPONSE PHONO (RIAA DEVIATION) CD (AUX)	±0.5dB 5Hz to 80kHz (-3dB)
TONE CONTROL BASS TREBLE	±8dB ±8dB
LOUDNESS CONTROL (VOLUME SET AT -30dB POSITION)	100Hz/+9dB 10kHz/+5dB
PHONO MAX. INPUT LEVEL	150mV
LOW CUT FILTER (SUBSONIC)	-3dB/18Hz
POWER REQUIREMENTS	120V, 60Hz for USA & Canada 220V, 50Hz for Europe except UK 240V, 50Hz for UK & Australia 110/102/220/240V, 50/60Hz switchable for other countries
DIMENSIONS	440 (W) × 98 (H) × 255 (D) mm (17.3 × 3.9 × 10 inches)
WEIGHT	6.15kg (13.53 lbs)

* For improvement purposes, specifications and design are subject to change without notice.

II. DISMANTLING OF UNIT

In case of trouble, etc. necessitating dismantling, please dismantle in the order shown in the photographs. Reassemble in reverse order.

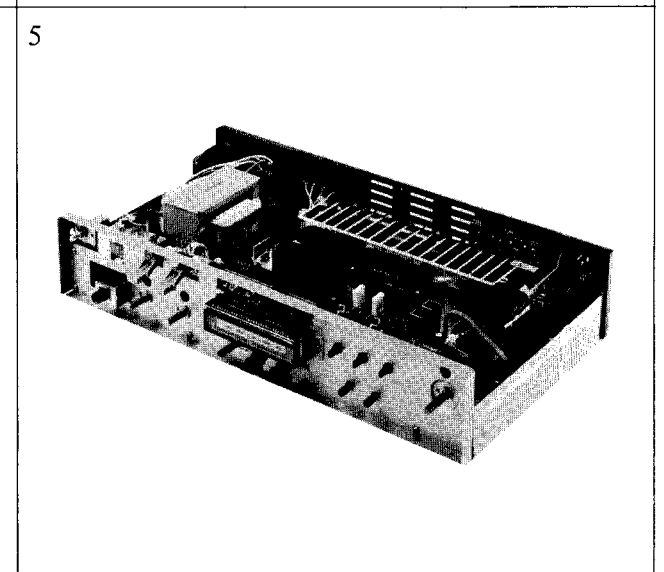
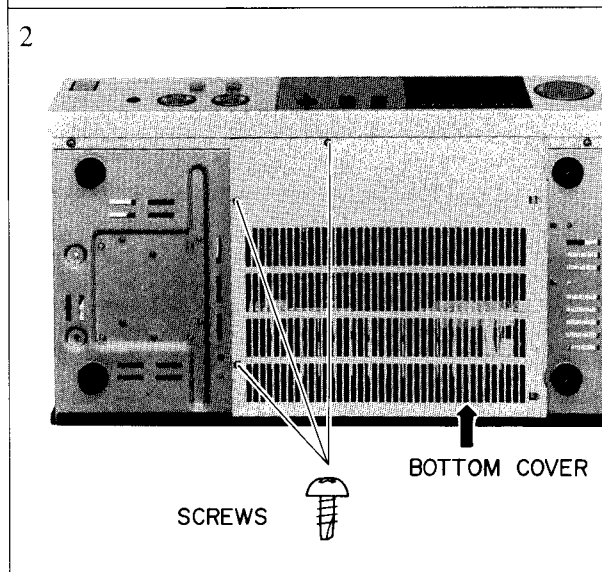
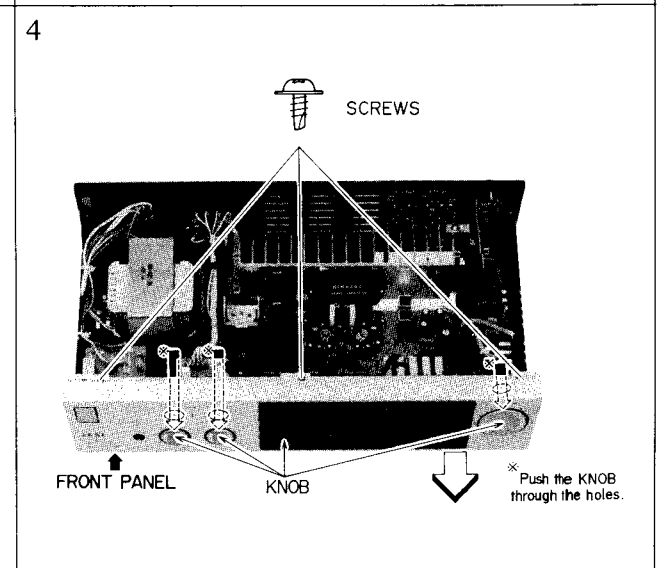
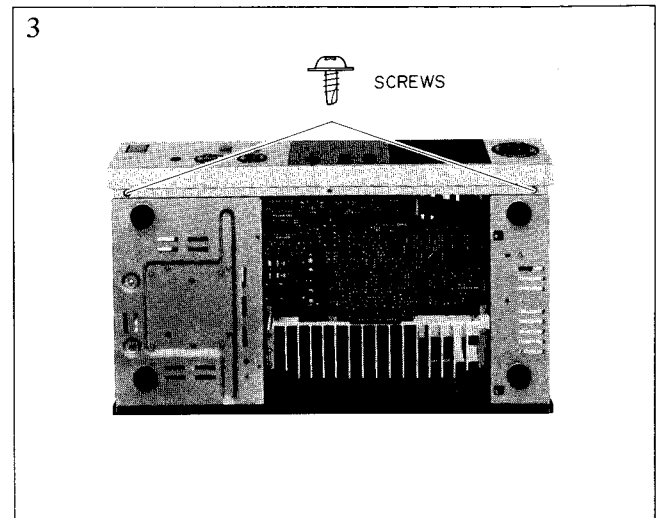
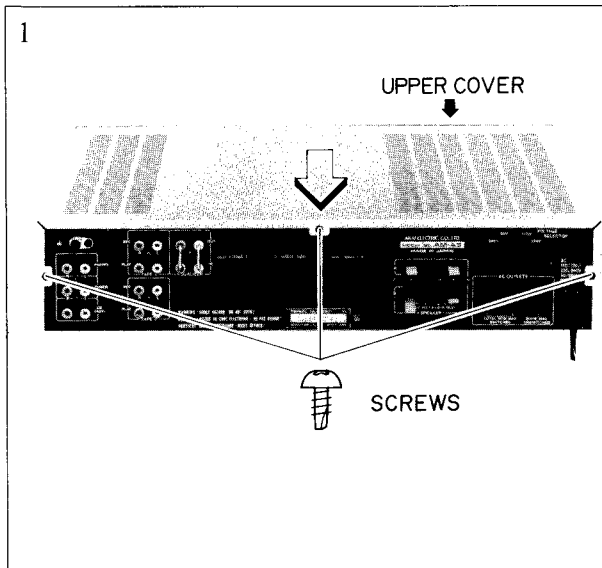

III. CONTROLS

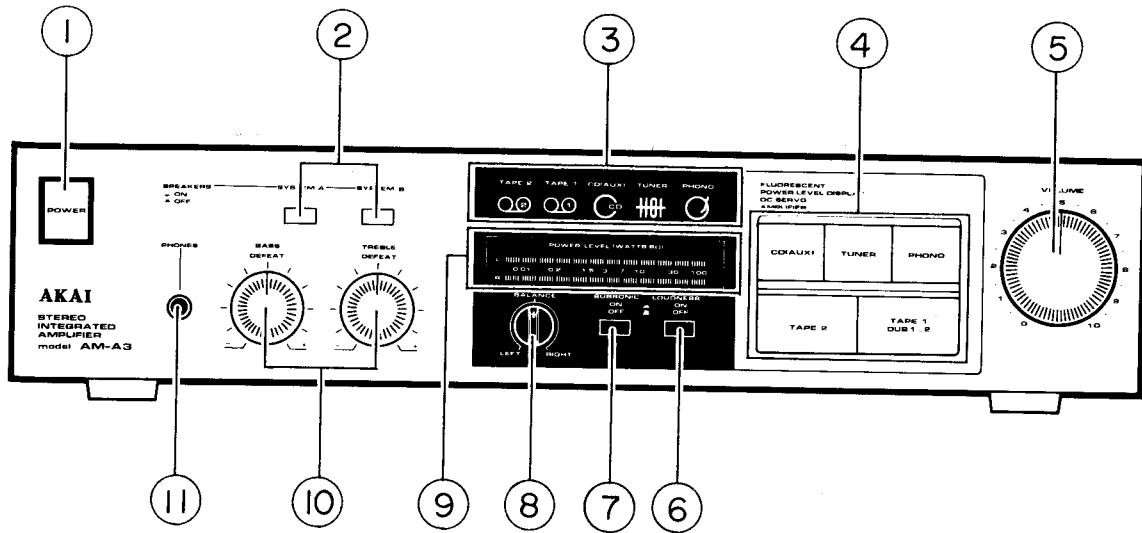

Fig. 3-1

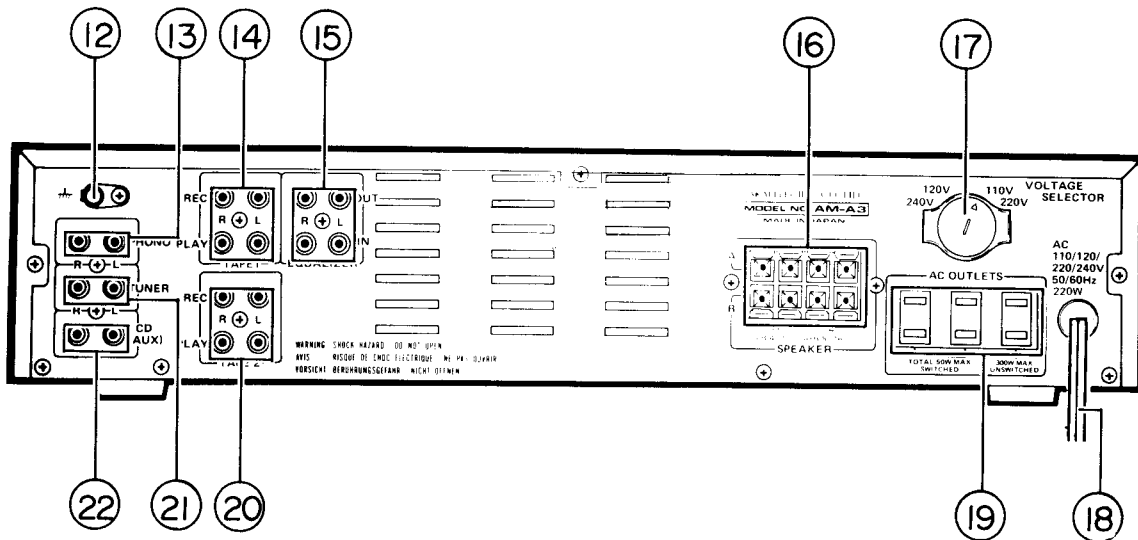

Fig. 3-2

- | | |
|---|---|
| <ol style="list-style-type: none"> 1. POWER SWITCH 2. SPEAKER SELECTOR BUTTONS (SYSTEM A AND SYSTEM B) 3. INPUT SOURCE INDICATORS (PHONO, TUNER, CD (AUX), TAPE 1 AND TAPE 2) 4. INPUT SOURCE SELECTOR BUTTONS (PHONO, TUNER, CD (AUX), TAPE 1 and TAPE 2) 5. VOLUME CONTROL 6. LOUDNESS BUTTON 7. SUBSONIC BUTTON 8. BALANCE CONTROL 9. POWER LEVEL INDICATOR 10. TONE (BASS, TREBLE) CONTROLS | <ol style="list-style-type: none"> 11. HEADPHONE JACK 12. GROUND TERMINAL 13. PHONO JACKS 14. TAPE 1 (REC AND PLAY) JACKS 15. EQUALIZER (IN AND OUT) JACKS 16. SPEAKER TERMINALS 17. VOLTAGE SELECTOR SWITCH (U MODEL ONLY) 18. AC POWER CORD 19. AC OUTLETS (U,C,A MODELS ONLY) 20. TAPE 2 (REC AND PLAY) JACKS 21. TUNER JACKS 22. CD (AUX) JACKS |
|---|---|

IV. PRINCIPAL PARTS LOCATION

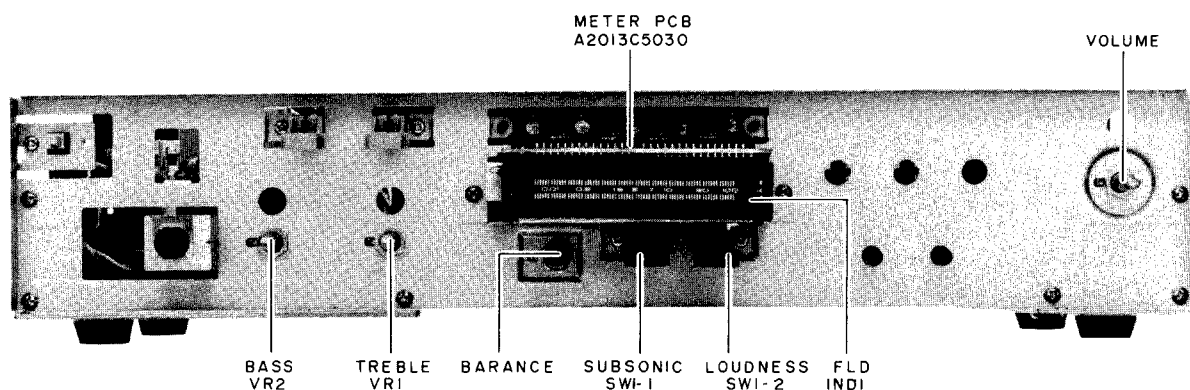

Fig. 4-1 Front View

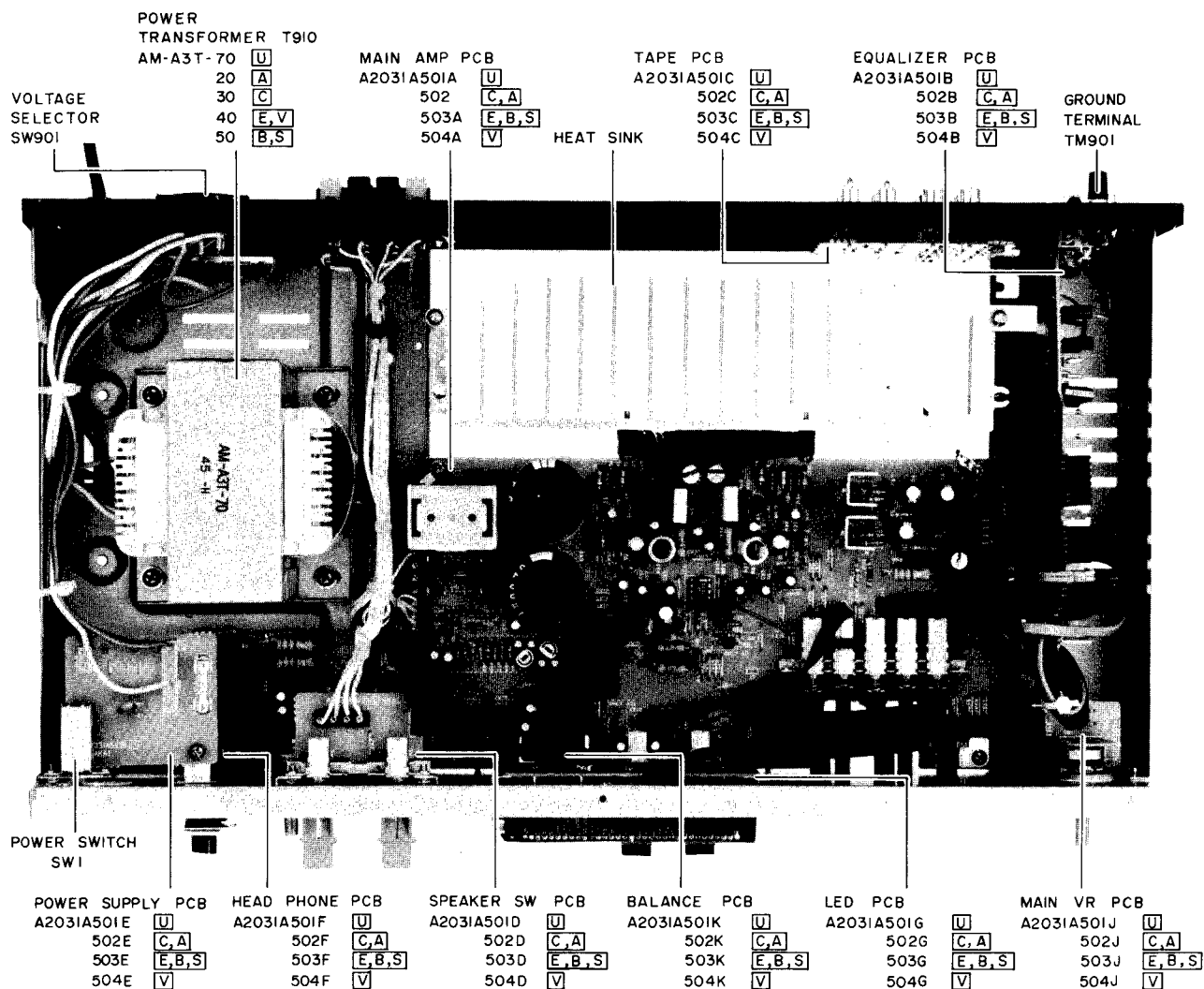

Fig. 4-2 Top View ([U] MODEL)

V. AMPLIFIER SECTION ADJUSTMENT

5-1 THE INSTRUMENT CONNECTION

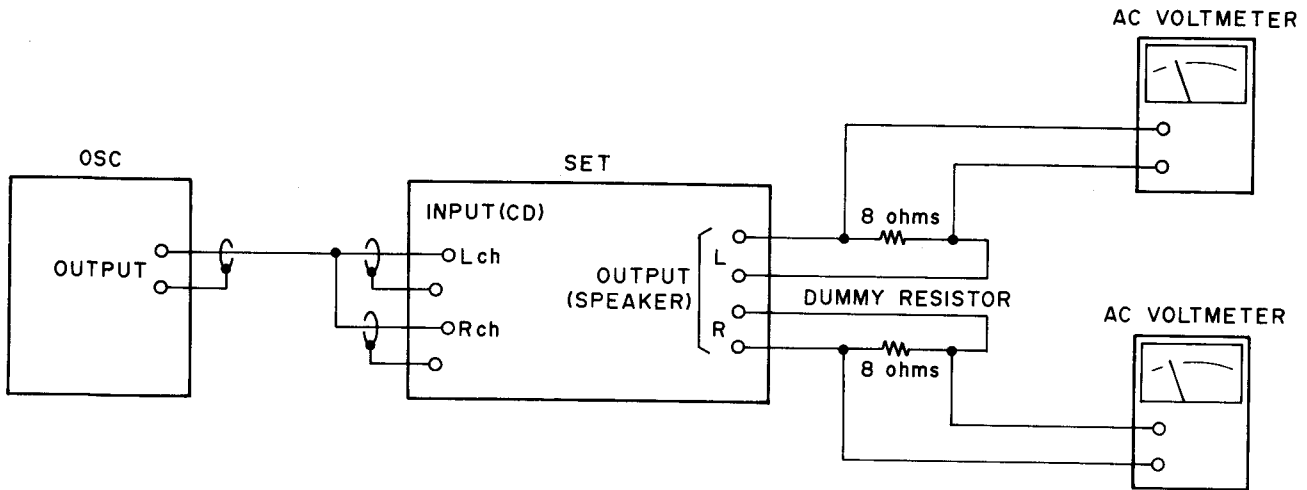

Fig. 5-1 Instrument Corrections for Amplifier Section Adjustment

5-2 MAIN AMP PC BOARD ADJUSTMENT POINTS

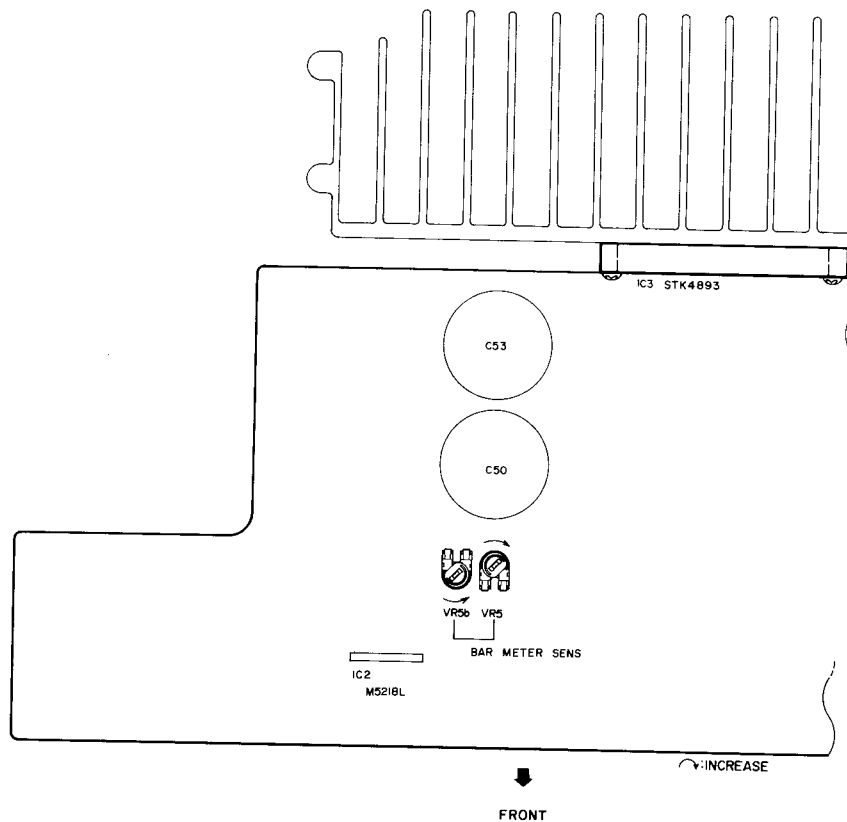

Fig. 5-2 Main-Amp PC Board

5-3 BAR (POWER LEVEL) METER ADJUSTMENT

- 1) Set VOLUME to maximum, TONE CONTROL to flat, BALANCE to center and LOUDNESS and SUBSONIC to off.
- 2) Supply 1kHz to CD (AUX) input jacks (both Left and Right CH), and adjust OSC output so that the both AC Voltmeters indicate 9.0V.
(If the AC meter indication is different between

Left CH and Right CH, adjust the lower voltage channel 9V.)

- 3) Adjust VR5 so that the BAR METER indicates 10W.
- 4) Adjust OSC output so that the AC voltmeter indicates 8.0V, then confirm that the BAR METER indicates 7W.

VI. PC BOARD TITLE AND IDENTIFICATIONS

PC BOARD TITLE		PC BOARD NUMBER	REMARKS
MAIN AMP	PC BOARD	A2031A501A	U
		502A	C,A
		503A	E,B,S
		504A	V
EQUALIZER	PC BOARD	A2031A501B	U
		502B	C,A
		503B	E,B,S
		504B	V
TAPE	PC BOARD	A2031A501C	U
		502C	C,A
		503C	E,B,S
		504C	V
SPEAKER SW	PC BOARD	A2031A501D	U
		502D	C,A
		503D	E,B,S
		504D	V
POWER SUPPLY	PC BOARD	A2031A501E	U
		502E	C,A
		503E	E,B,S
		504E	V
HEADPHONE	PC BOARD	A2031A501F	U
		502F	C,A
		503F	E,B,S
		504F	V
LED	PC BOARD	A2031A501G	U
		502G	C,A
		503G	E,B,S
		504G	V
FILTER	PC BOARD	A2031A504H	V
MAIN VR	PC BOARD	A2031A501J	U
		502J	C,A
		503J	E,B,S
		504J	V
BALANCE	PC BOARD	A2031A501K	U
		502K	C,A
		503K	E,B,S
		504K	V
SPEAKER TERMINAL	PC BOARD	A2031D5070	V
METER	PC BOARD	A2013C5030	

SECTION 2

PARTS LIST

TABLE OF CONTENTS

RECOMMENDED SPARE PARTS	13
1. PC BOARD BLOCK	13
2. MAIN AMP PC BOARD	14
3. EQUALIZER PC BOARD	14
4. TAPE PC BOARD	14
5. METER PC BOARD	14
6. LED PC BOARD	14
7. SPEAKER SW PC BOARD	14
8. MAIN VR PC BOARD	14
9. BALANCE PC BOARD	15
10. SPEAKER TERMINAL PC BOARD	15
11. POWER SUPPLY PC BOARD	15
12. FILTER PC BOARD	15
13. HEAD PHONE PC BOARD	15
14. ASSEMBLY BLOCK	15
15. FINAL ASSEMBLY BLOCK	16
INDEX	16

Resistor and Capacitor which is not listed in this parts list, please refer to
COMMON LIST FOR SERVICE PARTS.

ATTENTION

1. When placing an order for parts, be sure to list the parts no., model no., and description. There are instances in which if any of this information is omitted, parts cannot be shipped or the wrong parts will be delivered.
2. Please be careful not to make a mistake in the parts no. If the parts no. is in error, a part different from the one ordered may be delivered.
3. Because parts number and parts unit supply in the Preliminary Parts List may be partially changed, please use this parts list for all future reference.

HOW TO USE THIS PARTS LIST

1. This Parts List shows the parts that are considered necessary for repairs. Other parts, such as resistors and capacitors, are shown in the "Common List for Service Parts". Select and order such parts from the "Common List for Service Parts".
2. The Recommended Spare Parts shows those parts in the Parts List which are considered particularly important for service.
3. Parts not shown in the Parts List and "Common List for Service Parts" will not be supplied in principle.
4. How to read list
 - a) Mechanism Block
 - b) P.C Board Block

2. HEAD BASE BLOCK

REF. NO.	PARTS NO.	DESCRIPTION
2-1x	BH-T2023A320A	HEAD BASE BLOCK GX-F66R
2-2	HP-H2206A010A	HEAD R/P PR4-8FU C
2-3	ZS-477876	PAN20x03STL CMT
2-4	ZS-536488	BID20x08STL CMT
2-5	ZG-402895	CS ANGLE ADJUST SPRING

SP (Service Parts) Classification
 A small "x" indicates the inability to show that particular part in the Photo or Illustration.
 This number corresponds with the individual parts index number in that figure
 This number corresponds with the Figure Number

6. SYS. CON. P.C BOARD BLOCK

REF. NO.	PARTS NO.	DESCRIPTION
6-1	BA-T2034A070A	PC SYS CON BLK GX-F44R
6-IC1	EI-324536	IC HD14049BP
6-IC2	EI-336801	IC MB8841-564M
6-IC3	EI-331661	IC SN7405N
6-IC4	EI-336725	IC M54527P
6-TR1to4	ET-200985	TR 2SC2603 F,G
6-TR5to28	ET-554657	TR 2SA733A P,Q
6-D1	ED-318292	D SILICON H 1S2473T-77 T26
6-D2to4	ED-308952	D GERMA V 1K34A-LR F07
6-D5to10	ED-318292	D SILICON H 1S2473T-77 T26
6-X1	EI-318384	OSC X'TAL NC-18C 3.579545MHZ

SP (Service Parts) Classification
 This reference numbers corresponds with symbol numbers of Schematic Diagrams.

5. Both the kind of part and installation position can be determined by the Parts Number. To determine where a part number is listed, utilize Parts Index at end of Parts List. It is necessary first of all to find the Parts Number. This can be accomplished by using the Reference Number listed at right of parts number in the Parts Index.

WARNING

△ INDICATES SAFETY CRITICAL COMPONENTS FOR CONTINUED SAFETY, REPLACE SAFETY CRITICAL COMPONENTS ONLY WITH MANUFACTURE'S RECOMMENDED PARTS

AVERTISSEMENT

△ IL INDIQUE LES COMPOSANTS CRITIQUES DE SÉCURITÉ. POUR MAINTENIR LE DEGRÉ DE SÉCURITÉ DE L'APPAREIL, NE REMPLACER QUE DES PIÈCES RECOMMANDÉES PAR LE FABRICANT

RECOMMENDED SPARE PARTS

Because, if the parts listed below are on hand, almost any repair can be accomplished, we suggest that you stock these Recommended Spare Parts Items.

REF. NO.	PARTS NO.	DESCRIPTION
1	BT-352434	△ TRANS POWER AM-A3T-20 (A)
2	BT-352433	△ TRANS POWER AM-A3T-30 (C)
3	BT-352435	△ TRANS POWER AM-A3T-40 (IE,V)
4	BT-352436	△ TRANS POWER AM-A3T-50 (B,S)
5	BT-352432	△ TRANS POWER AM-A3T-70 (U)
6	ED-309341	D GERMA H 1 K34A
7	ED-349656	D LED AY5505S
8	ED-337391	D LED GL5NG6 GRN
9	ED-200749	D SILICON DBA60-K15 400/6.0A
10	ED-348990	D SILICON H DS446
11	ED-301911	D SILICON H DS448
12	ED-306320	D ZENER H HZ15 2
13	ED-324013	D ZENER H HZ20 2
14	ED-329056	D ZENER H HZ22 2
15 N	ED-346433	D ZENER H HZ4FA F10 B2
16	EF-601301	△ FUSE SEMKO T 250V 2.00A (B)
17	EF-242605	△ FUSE SEMKO T 250V 6.30A (E,V,B,S)
18	EF-306952	△ FUSE TSC A 250V 4.00A (U)
19	EF-306957	△ FUSE TSC 125V 4.00A (C)
20	EF-346115	△ FUSE TSC 125V 6.30A (C,A)
21	EI-315799	IC HA12019
22	EI-344490	IC LA6458D
23	EI-337228	IC M5218L0
24	EI-344764	IC M5218P-21
25	EI-352640	IC STK4893
26	EI-354080	IC UPC1237H
27	EM-336916	IND FL BG189Z GRAPH
28	EQ-337159	RELAY POW G4Z-2282P 2N0 24V
29	ER-337756	△ R FUSE ERD2FC S10 1/4W 4700G
30	ER-349423	△ R FUSE ERD2FC S10 1/4W 5600G
31	ER-200746	△ R FUSE ERD2FC 1/4W 1000G
32	ES-337902	△ SW PUSH SDDL1P 01-1
33	ES-349070	△ SW SELECTOR YKS11-0002 02-4 (U) (SW901)
34	ES-352624	SW PUSH ESB-62838 2 THROW
35	ES-352632	SW PUSH ESB-62839 5-THROW
36	ES-352639	SW PUSH ESB-62949
37	ET-305463	TR 2SA970 GR,BL
38	ET-322598	TR 2SB632K E,F
39	ET-307195	TR 2SC2240 GR,BL
40	ET-403413	TR 2SC536NP H
41	ET-310148	TR 2SD612K E,F
42	EV-315540	R S-FIX H D8 3P 502
43	EV-352622	VR ROTARY 16P10×1T W105
44	EV-352621	VR ROTARY 16P20×B104
45	EV-352645	VR ROTARY 16P20×3R C104 OPEN
46	EV-352646	VR ROTARY 16P20×3S C104 SHORT

“NOTE” N : New Parts

SYMBOL FOR DESTINATION

- A : AAL (U.S.A.)
- B : UK (England)
- C : CSA (Canada)
- E : CEE (Europe)
- S : SAA (Australia)
- U : U/T (Universal Area)
- V : VDE (West Germany)

1. PC BOARD BLOCK

REF. NO.	PARTS NO.	DESCRIPTION
----------	-----------	-------------

MAIN PC BOARD BLOCK

1-1A	BA-A2031A020A	PC MAIN BLK AM-A3 (U)
1-1B	BA-A2031A020B	PC MAIN BLK AM-A3 (C)
1-1C	BA-A2031A020C	PC MAIN BLK AM-A3 (E,S)
1-1D	BA-A2031A020D	PC MAIN BLK AM-A3 (V)
1-1E	BA-A2031A020E	PC MAIN BLK AM-A3 (B)
1-1F	BA-A2031A020F	PC MAIN BLK AM-3 (A)

NOTE: MAIN PC BOARD BLOCK Consists of following PC BOARDS

- MAIN AMP PC BOARD
- EQUALIZER PC BOARD
- TAPE PC BOARD
- LED PC BOARD
- SPEAKER SW PC BOARD
- MAIN VR PC BOARD
- BALANCE PC BOARD
- POWER SUPPLY PC BOARD
- FILTER PC BOARD
- HEAD PHONE PC BOARD

2. MAIN AMP PC BOARD

REF. NO.	PARTS NO.	DESCRIPTION
2-IC2	EI-337228	IC M5218L0
2-IC3	EI-352640	△ IC STK4893
2-IC4	EI-344490	IC LA6458D
2-IC5	EI-354080	IC UPC1237H
2-TR1	ET-310148	△ TR 2SD612K E,F
2-TR2	ET-322598	△ TR 2SB632K E,F
2-TR3	ET-305463	TR 2SA970 GR,BL
2-TR4	ET-307195	TR 2SC2240 GR,BL
2-TR5	ET-403413	TR 2SC536NP H
2-D1	ED-301911	D SILICON H DS448
2-D2	ED-348990	D SILICON H DS446
2-D3	ED-301911	D SILICON H DS448
2-D4	ED-348990	△ D SILICON H DS446
2-D5	ED-329056	D ZENER H HZ22 2
2-D6	ED-306320	△ D ZENER H HZ15 2
2-D7	ED-324013	△ D ZENER H HZ20 2
2-D8	ED-200749	△ D SILICON DBA60-K15 400/6.0A
2-D9	ED-309341	D GERMA H 1K34A
2-D10	ED-301911	D SILICON H DS448
2-D11	ED-305704	D ZENER H HZ4 B2
2-SW1	ES-352639	SW PUSH ESB-62949
2-SW2	ES-352632	SW PUSH ESB-62839 5-THROW
2-VR1	EV-352645	VR ROTARY 16P20x3R C104 OPEN
2-VR2	EV-352646	VR ROTARY 16P20x3S C104 SHORT
2-VR5	EV-315540	R S-FIX H D8 3P 502
2-RL1	EQ-337159	RELAY POW G4Z-2282P 2NO 24V
2-FR1	ER-349423	△ R FUSE ERD2FC S10 1/4W 5600G
2-FR2	ER-337756	△ R FUSE ERD2FC S10 1/4W 4700G
2-FR3	ER-200746	△ R FUSE ERD2FC 1/4W 1000G
2-R30	ER-333598	△ R CB H S15 FS RDS 1/2W 102J
2-R31	ER-315082	△ R CB H F10 RDS 1/4W 332J
2-R39	ER-352651	△ R OMF H S15 FS 1W 4R7J
2-R40	ER-337754	△ R OMF H S15 FS 1W 100J
2-R41	ER-345466	△ R CT F09 PLATE 5W R22K
2-R46	ER-333067	△ R OMF H S20 FS 2W 821J
2-R51	ER-333609	△ R CB H S15 FS RDS 1/2W 123J
2-R56	ER-658034	△ R OMF H FS 2W 221J
2-R60	ER-323075	△ R CB H S10 FS RDS 1/4W 472J
2-R61	ER-323074	△ R CB H S10 FS RDS 1/4W 102J
2-R62	ER-302241	△ R CB H S10 FS RDS 1/4W 4R7J
2-R63	ER-328071	△ R CB H S10 FS RDS 1/4W 392J
2-R64	ER-323074	△ R CB H S10 FS RDS 1/4W 102J
2-R65	ER-302241	△ R CB H S10 FS RDS 1/4W 4R7J
2-R83	ER-322591	△ R CB H S10 FS RDS 1/4W 101J
2-C10,31	EC-343855	C EC V F05 NP SM R22M 50.0DC
2-C32,33	EC-325320	C EC V F05 NP AWA 2R2M 50DC
2-C38	EC-311689	C EC V CUT NP 04D 331M 6.3DC
2-C50	EC-354664	C EC V CUT 822 56.0DC
2-C52	EC-326583	C MMY V CUT CF921 473K 400DC
2-C53	EC-354664	C EC V CUT 822 56.0DC
2-F3A	EF-346115	△ FUSE TSC 125V 6.30A (C,A)
2-F3B	EF-242605	△ FUSE SEMKO T 250V 6.30A (E,V,B,S)
2-F4A	EF-346115	△ FUSE TSC 125V 6.30A (C,A)
2-F4B	EF-242605	△ FUSE SEMKO T 250V 6.30A (E,V,B,S)

3. EQUALIZER PC BOARD

REF. NO.	PARTS NO.	DESCRIPTION
3-IC1	EI-344764	IC M5218P-21
3-L1	EO-338420	COIL FIX 2 FL12R202E 202K (V)
3-L2	EO-345907	COIL FIX 1 LAL03KH 3R3K (V)
3-L3	EO-345907	COIL FIX 1 LAL03KH 3R3K (V)
3-R9	ER-200939	R CB H S10 FS RDS 1/4W 181J
3-J1	EJ-344370	PIN J YKC21-0081 P 6 P

4. TAPE PC BOARD

REF. NO.	PARTS NO.	DESCRIPTION
4-L1 to 5	EO-336934	COIL FIX 1 LAL03KH 2R2M (V)
4-J1 to 3	EJ-343365	PIN J YMC21-0063 P 4 P

5. METER PC BOARD

REF. NO.	PARTS NO.	DESCRIPTION
5-IC1	EI-315799	IC HA12019
5-IND1	EM-336916	IND FL BG189Z GRAPH

6. LED PC BOARD

REF. NO.	PARTS NO.	DESCRIPTION
6-D1	ED-349656	D LED AY5505S
6-D2 to 4	ED-337391	D LED GL5NG6 GRN
6-D5	ED-349656	D LED AY5505S
6-R70 to 4	ER-617940	R CB H RD 1/2W 122J

7. SPEAKER SW PC BOARD

REF. NO.	PARTS NO.	DESCRIPTION
7-SW1	ES-352624	SW PUSH ESB-62838 2 THROW

8. MAIN VR PC BOARD

REF. NO.	PARTS NO.	DESCRIPTION
8-VR1	EV-352621	VR ROTARY 16P20X B104

9. BALANCE PC BOARD

REF. NO.	PARTS NO.	DESCRIPTION
9-VR1	EV-352622	VR ROTARY 16P10x1T W105

10. SPEAKER TERMINAL PC BOARD

REF. NO.	PARTS NO.	DESCRIPTION
10-L1	EO-342936	COIL BALUN
10-TM902	EJ-349401	TERMINAL LEVER YKD21-0027 8P

11. POWER SUPPLY PC BOARD

REF. NO.	PARTS NO.	DESCRIPTION
11-C1A	EC-320548	△ C CE V F 103Z 250AC (U)
11-C1B	EC-338411	△ C CE V FZ 103P 400AC (C,A)
11-C1C	EC-338496	△ C CE V FZ 472P 400AC (E,V,B,S)
11-F1A	EF-306952	△ FUSE TSC A 250V 4.00A (U)
11-F1B	EF-306957	△ FUSE TSC 125V 4.00A (C)
11-F1C	EF-601301	△ FUSE SEMKO T 250V 2.00A (B)

12. FILTER PC BOARD

REF. NO.	PARTS NO.	DESCRIPTION
12-FL1	EO-338409	COIL LF FKOB160MH02 250UH (V)

13. HEAD PHONE PC BOARD

REF. NO.	PARTS NO.	DESCRIPTION
13-L1	EO-336934	COIL FIX 1 LAL03KH 2R2M (V)
13-J1	EJ-343380	PHONE J 3P HLJ0541-040 6.3 (EXCEPT BL)
13-J1B	EJ-355012	PHONE J 3P HLJ0541-010 6.3 (BL)

ASSEMBLY BLOCK

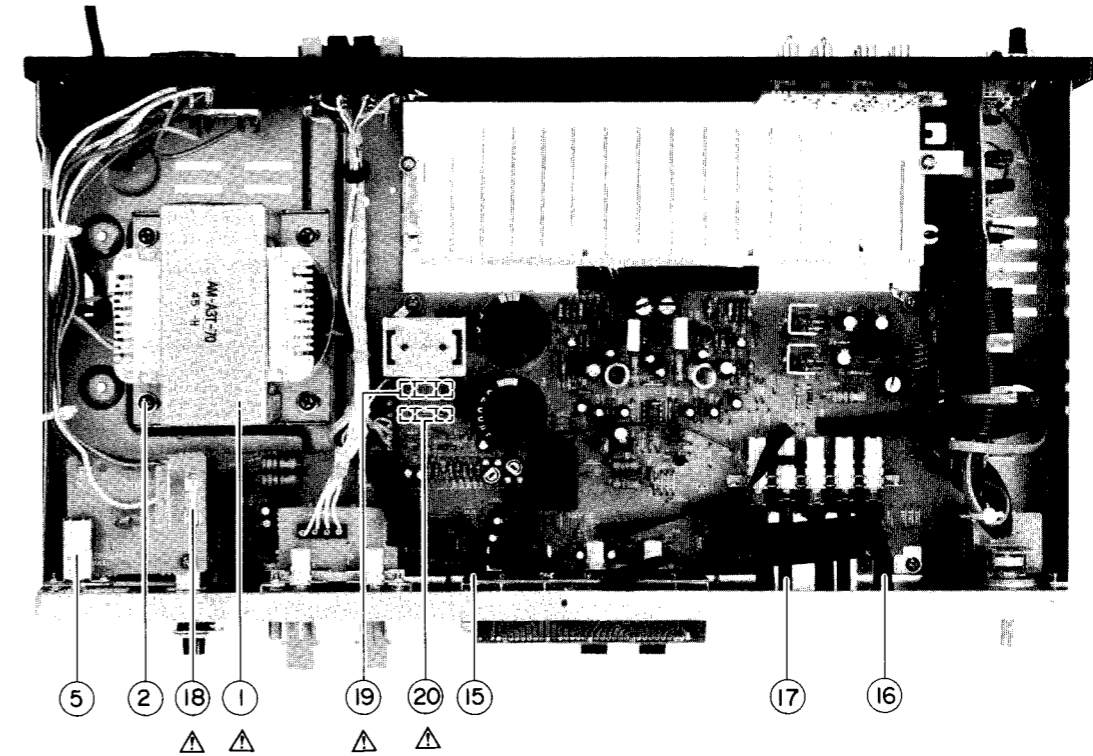
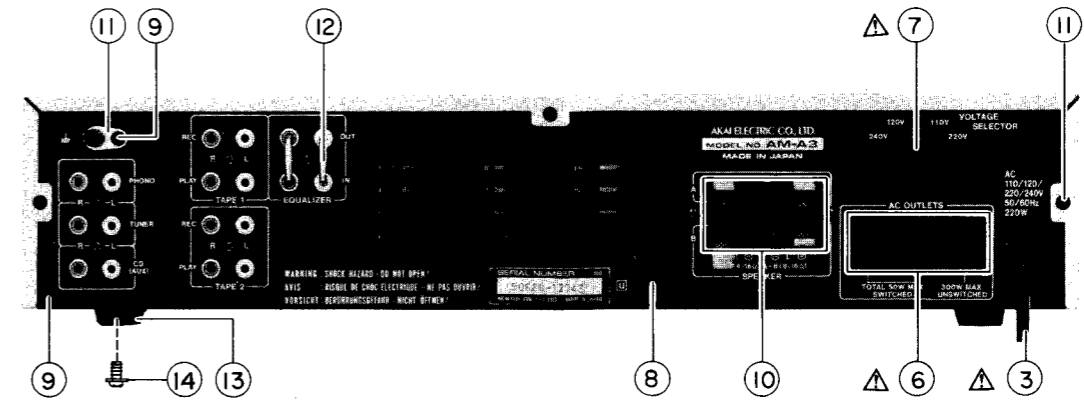

14. ASSEMBLY BLOCK

REF. NO.	PARTS NO.	DESCRIPTION
14-1A	BT-352432	△ TRANS POWER AM-A3T-70 (U)
14-1B	BT-352433	△ TRANS POWER AM-A3T-30 (C)
14-1C	BT-352434	△ TRANS POWER AM-A3T-20 (A)
14-1D	BT-352435	△ TRANS POWER AM-A3T-40 (E,V)
14-1E	BT-352436	△ TRANS POWER AM-A3T-50 (B,S)
14-2	ZS-346742	ST BID40x08STL CMT CPU
14-3A	EW-354515	△ AC CORD 2 CORES KP-700A, VFF-CB U/T (U)
14-3B	EW-349427	△ AC CORD 2 CORES KP-8W, SPT-2 UC (C)
14-3C	EW-349428	△ AC CORD 2 CORES KP-8W, SPT-1 UC (A)
14-3D	EW-354625	△ AC CORD 2 CORES KP-419C, LTCE-2F E (E)
14-3E	EW-354513	△ AC CORD 2 CORES KP-419C, LTCE-2F EV (V)
14-3F	EW-354512	△ AC CORD 2 CORES LTBS-2F-CB B (B)

REF. NO.	PARTS NO.	DESCRIPTION
14-3G	EW-354514	△ AC CORD 2 CORES KP-560, LTSA2F-CB S (S)
14-4x	EZ-631945	STRAIN RELIEF SR-4N-4 (C,A)
14-5	ES-337902	△ SW PUSH SDLD1P 01-1 (SW1)
14-6A	EJ-337405	△ SOCKET OUTLET S2T733T164 JUC 3x2P (U) (J901)
14-6B	EJ-352642	△ SOCKET OUTLET S2T733T114T (C,A) (J901)
14-7	ES-349070	△ SW SELECTOR TKS11-0002 D2-4 (U) (SW901)
14-8A	SP-349930A	PANEL REAR AM-A3 (U)
14-8B	SP-349930B	PANEL REAR AM-A3 (C,A)
14-8C	SP-349930C	PANEL REAR AM-A3 (E,V)
14-8D	SP-349930D	PANEL REAR AM-A3 (B,S)
14-9	ZS-308846	T2BR30x08STL BZN PROJECTION
14-10A	EJ-351485	TERMINAL PUSH YKD21-0148A S 8P (EXCEPT V)
14-10B	EJ-349401	TERMINAL LEVER YKD21-0027 8P (V)

REF. NO.	PARTS NO.	DESCRIPTION
14-11	EJ-329610	TERMINAL W/SCREW UB-0067 L 1P
14-12	EJ-348218	PLUG SHORT PIN P2138
14-13	SA-202118	FOOT
14-14	ZS-498273	T2BR30x08STL CMT PW080
14-15	ZW-698308	RV NYL30x055 BL
14-16	TA-349937	JOINT (B)
14-17	TA-349938	JOINT (C)
14-18A	EF-306952	△ FUSE TSC A 250V 4.00A (U) (F1)
14-18B	EF-306957	△ FUSE TSC 125V 4.00A (C) (F1)
14-18C	EF-601301	△ FUSE SEMKO T 250V 2.00A (B) (F1)
14-19A	EF-346115	△ FUSE TSC 125V 6.30A (C,A) (F3)
14-19B	EF-242605	△ FUSE SEMKO T 250V 6.30A (E,V,B,S) (F3)
14-20A	EF-346115	△ FUSE TSC 125V 6.30A (C,A) (F4)
14-20B	EF-242605	△ FUSE SEMKO T 250V 6.30A (E,V,B,S) (F4)
14-21x	ZW-305013	RV POP32 (A)

15. FINAL ASSEMBLY BLOCK

REF. NO.	PARTS NO.	DESCRIPTION
15-1	BD-A2031A030A	PANEL FRONT BLK AM-A3
15-1P	BD-A2031A030B	PANEL FRONT BLK AM-A3-P
15-1B	BD-A2031A030C	PANEL FRONT BLK AM-A3-B
15-2	SK-343017C	KNOB POWER (2)
15-2P	SK-343017D	KNOB POWER (2)-P
15-2B	SK-343017F	KNOB POWER-B
15-3	SK-349943A	KNOB (C-1) (EXCEPT BL)
15-3B	SK-349943D	KNOB (C-1)-B (BL)
15-4	SK-349943B	KNOB (C-2) (EXCEPT BL)
15-4B	SK-349943E	KNOB (C-2)-B (BL)
15-5	SK-349943C	KNOB (C-3) (EXCEPT BL)
15-5B	SK-349943F	KNOB (C-3)-B (BL)
15-6	SK-349941A	KNOB (D-1) (EXCEPT BL)
15-6B	SK-349941E	KNOB (D-1)-B (BL)
15-7	SK-349941B	KNOB (D-2) (EXCEPT BL)
15-7B	SK-349941F	KNOB (D-2)-B (BL)
15-8	SK-332591A	KNOB VOLUME (A) (EXCEPT BL)
15-8B	SK-332591E	KNOB VOLUME (A-5) (BL)
15-9	SK-345375G	KNOB VOLUME (E)
15-9P	SK-345375D	KNOB VOLUME (B)-P
15-9B	SK-345375K	KNOB VOLUME (H)-B
15-10	SK-349939A	KNOB (A)
15-10P	SK-349939B	KNOB (A)-P
15-10B	SK-349939C	KNOB (A)-B
15-11	SK-349940A	KNOB (B-1)
15-12	SK-349940B	KNOB (B-2)
15-12P	SK-349940C	KNOB (B-3)
15-12B	SK-349940A	KNOB (B-1)
15-13	SP-349925A	COVER UPPER
15-13P	SP-349925B	COVER UPPER-P
15-13B	SP-349925C	COVER UPPER-B

SYMBOL FOR COLOR VARIATION

NON : STANDARD COLOR

P : PEARL SHADOW

B or BL : BLACK

FINAL ASSEMBLY BLOCK

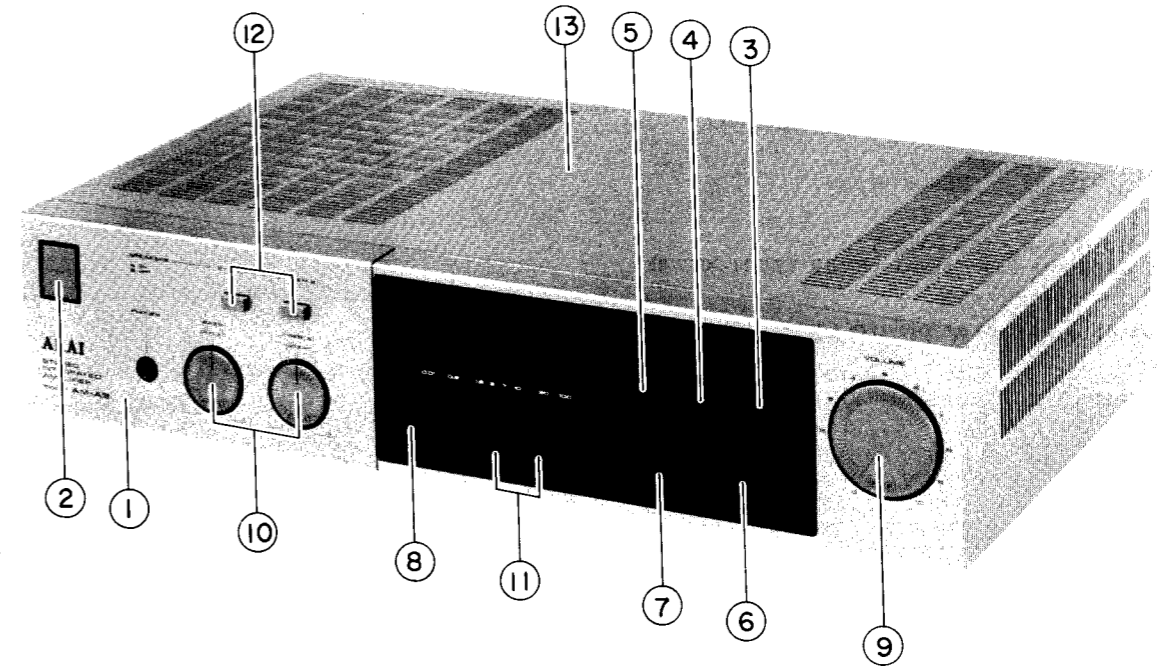

INDEX

PARTS NO.	REF. NO.	PARTS NO.	REF. NO.	PARTS NO.	REF. NO.	PARTS NO.	REF. NO.	PARTS NO.	REF. NO.
BA-A2031A020A	1-1A	ED-349656	6-D5	EO-336934	13-L1	ET-403413	2-TR5	SP-349925A	15-13
BA-A2031A020B	1-1B	EF-242605	2-F3B	EO-338409	12-FL1	EV-315540	2-VR5	SP-349925B	15-13P
BA-A2031A020C	1-1C	EF-242605	2-F4B	EO-338420	3-L1	EV-352621	8-VR1	SP-349925C	15-13B
BA-A2031A020D	1-1D	EF-242605	14-19B	EO-342936	10-L1	EV-352622	9-VR1	SP-349930A	14-8A
BA-A2031A020E	1-1E	EF-242605	14-20B	EO-345907	3-L3	EV-352645	2-VR1	SP-349930B	14-8B
BA-A2031A020F	1-1F	EF-306952	11-F1A	EO-345907	3-L2	EV-352646	2-VR2	SP-349930C	14-8C
BD-A2031A030A	15-1	EF-306952	14-18A	EQ-337159	2-RL1	EW-349427	14-3B	SP-349930D	14-8D
BD-A2031A030B	15-1P	EF-306957	11-F1B	ER-200746	2-FR3	EW-349428	14-3C	TA-349937	14-16
BD-A2031A030C	15-1B	EF-306957	14-18B	ER-200939	3-R9	EW-354512	14-3F	TA-349938	14-17
BT-352432	14-1A	EF-346115	2-F3A	ER-302241	2-R62	EW-354513	14-3E	ZS-308846	14-9
BT-352433	14-1B	EF-346115	2-F4A	ER-302241	2-R65	EW-354514	14-3G	ZS-346742	14-2
BT-352434	14-1C	EF-346115	14-19A	ER-315082	2-R31	EW-354515	14-3A	ZS-498273	14-14
BT-352435	14-1D	EF-346115	14-20A	ER-322591	2-R83	EW-354625	14-3D	ZW-305013	14-21x
BT-352436	14-1E	EF-601301	11-F1C	ER-323074	2-R61	EZ-631945	14-4x	ZW-698308	14-15
EC-311689	2-C38	EF-601301	14-18C	ER-323074	2-R64	SA-202118	14-13		
EC-320548	11-C1A	EI-315799	5-IC1	ER-323075	2-R60	SK-332591A	15-8		
EC-325320	2-C32	EI-337228	2-IC2	ER-328071	2-R53	SK-332591E	15-8B		
EC-325320	2-C33	EI-344490	2-IC4	ER-330067	2-R46	SK-343017C	15-2		
EC-326583	2-C52	EI-344764	3-IC1	ER-333598	2-R30	SK-343017D	15-2P		
EC-338411	11-C1B	EI-352640	2-IC3	ER-333609	2-R51	SK-343017F	15-2B		
EC-338496	11-C1C	EI-354080	2-IC5	ER-337754	2-R40	SK-345375D	15-9P		
EC-343855	2-C10	EJ-329610	14-11	ER-337756	2-FR2	SK-345375G	15-9		
EC-343855	2-C31	EJ-337405	14-6A	ER-345466	2-R41	SK-345375K	15-9B		
EC-354664	2-C50	EJ-343365	4-J1	ER-349423	2-FR1	SK-349939A	15-10		
EC-354664	2-C53	EJ-343365	4-J2	ER-352651	2-R39	SK-349939B	15-10P		
ED-200749	2-D8	EJ-343365	4-J3	ER-617940	6-R70	SK-349939C	15-10B		
ED-301911	2-D1	EJ-343380	13-J1	ER-617940	6-R72	SK-349940A	15-11		
ED-301911	2-D3	EJ-344370	3-J1	ER-617940	6-R73	SK-349940A	15-11		
ED-301911	2-D10	EJ-348218	14-12	ER-617940	6-R74	SK-349940A	15-12B		
ED-305704	2-D11	EJ-349401	10-TM902	ER-617940	6-R71	SK-349940B	15-12		
ED-306320	2-D6	EJ-349401	14-10B	ER-658034	2-R56	SK-349940C	15-12P		
ED-309341	2-D9	EJ-351485	14-10A	ES-337902	14-5	SK-349941A	15-6		
ED-324013	2-D7	EJ-352642	14-6B	ES-349070	14-7	SK-349941B	15-7		
ED-329056	2-D5	EJ-355012	13-J1B	ES-352624	7-SW1	SK-349941E	15-6B		
ED-337391	6-D2	EM-336916	5-IND1	ES-352632	2-SW2	SK-349941F	15-7B		
ED-337391	6-D3	EO-336934	4-L2	ES-352639	2-SW1	SK-349943A	15-3		
ED-337391	6-D4	EO-336934	4-L3	ET-305463	2-TR3	SK-349943B	15-4		
ED-348990	2-D2	EO-336934	4-L4	ET-307195	2-TR4	SK-349943C	15-5		
ED-348990	2-D4	EO-336934	4-L5	ET-310148	2-TR1	SK-349943D	15-3B		
ED-349656	6-D1	EO-336934	4-L1	ET-322598	2-TR2	SK-349943E	15-4B		
						SK-349943F	15-5B		