

# AKAI SERVICE MANUAL

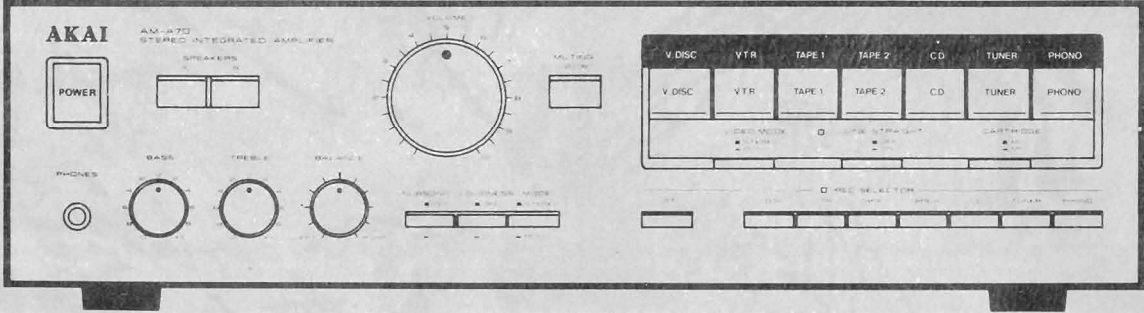

STEREO INTEGRATED AMPLIFIER

MODEL **AM-A70**

# ABBREVIATIONS FOR SERVICE MANUAL

## MODEL AM-A70

ABBREVIATIONS	EXPLANATION
AC	Alternating Current
AMP	AMPlifier
CD	Compact Disc
DC	Direct Current
GND	GrOuND
MC	Moving Coil
MM	Moving Magnet
PCB	Printed Circuit Board
REC	RECOrd
SW	SWitch
V.DISC	Video DISC
VR	Variable Resistance
VTR	Video Tape Recorder

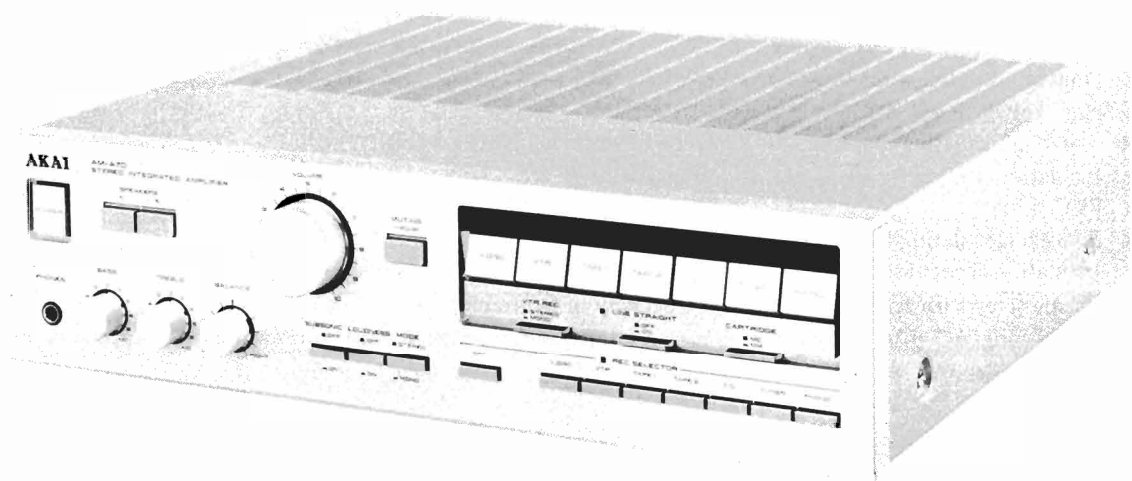

## STEREO INTEGRATED AMPLIFIER

### MODEL **AM-A70**

SECTION 1	SERVICE MANUAL .....	3
SECTION 2	PARTS LIST .....	11

# SAFETY INSTRUCTIONS

## SAFETY CHECK AFTER SERVICING

Confirm the specified insulation resistance between power cord plug prongs and externally exposed parts of the set is greater than 10 Mohms, but for equipment with external antenna terminals (tuner, receiver, etc.) and is intended for [C] or [A], specified insulation resistance should be more than 2.2 Mohms (ground terminals, microphone jacks, headphone jacks, line-in-out jacks etc.)

## PRECAUTIONS DURING SERVICING

1. Parts identified by the  $\triangle$  symbol parts are critical for safety.  
Replace only with parts number specified.
2. In addition to safety, other parts and assemblies are specified for conformance with such regulations as those applying to spurious radiation. These must also be replaced only with specified replacements.  
Examples: RF converters, tuner units, antenna selector switches, RF cables, noise blocking capacitors, noise blocking filters, etc.
3. Use specified internal wiring. Note especially:
  - 1) Wires covered with PVC tubing
  - 2) Double insulated wires
  - 3) High voltage leads
4. Use specified insulating materials for hazardous live parts. Note especially:
  - 1) Insulation Tape
  - 2) PVC tubing
  - 3) Spacers (Insulating Barriers)
  - 4) Insulation sheets for transistors
  - 5) Plastic screws for fixing microswitch (especially in turntable)
5. When replacing AC primary side components (transformers, power cords, noise blocking capacitors, etc.), wrap ends of wires securely about the terminals before soldering.

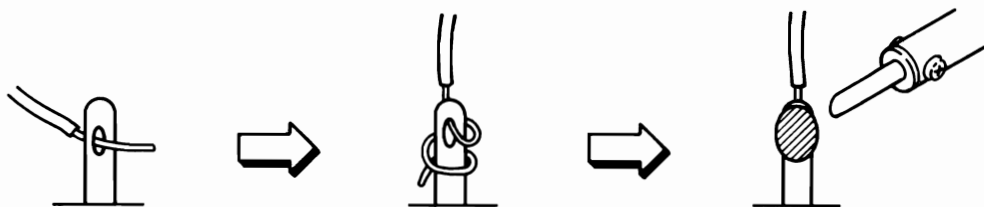

6. Observe that wires do not contact heat producing parts (heatsinks, oxide metal film resistors, fusible resistors, etc.).
7. Check that replaced wires do not contact sharp edged or pointed parts.
8. Also check areas surrounding repaired locations.
9. Use care that foreign objects (screws, solder droplets, etc.) do not remain inside the set.

## VOLTAGE CONVERSION

Models for Canada, USA, Europe, UK and Australia are not equipped with this facility. Each machine is preset at the factory according to destination, but some machines can be set to 110V, 120V, 220V, or 240V as required.

If your machine's can be converted:

Before connecting the power cord, turn the VOLTAGE SELECTOR located on the rear panel with a screwdriver until the correct voltage is indicated.

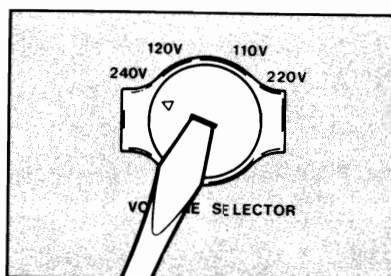

---

SECTION 1

**SERVICE MANUAL**

TABLE OF CONTENTS

I.	SPECIFICATIONS .....	4
II.	DISMANTLING OF UNIT .....	5
III.	CONTROLS .....	6
IV.	PRINCIPAL PARTS LOCATION .....	7
V.	ADJUSTMENTS .....	8
	1. EQ AMP DC BALANCE ADJUSTMENT .....	8
	2. IDLING CURRENT ADJUSTMENT .....	8
VI.	PC BOARD TITLE AND IDENTIFICATIONS .....	9

For basic adjustments, measuring methods, and operating principles, refer to GENERAL TECHNICAL MANUAL.

# I. SPECIFICATIONS

## POWER AMPLIFIER SECTION

RATED POWER OUTPUT 20Hz to 20kHz	8 ohms      4 ohms 100W/0.5%    150W/0.7%
POWER OUTPUT (by FTC) 20Hz to 20kHz DIN 1kHz	100W/0.5%    150W/0.7% 110W/0.7%
POWER BANDWIDTH (IHF -3dB, 8 ohms)	10Hz to 80kHz (1.0%)
S/N (IHF-A) PHONO (MM) PHONO (MC) CD/AUX	86dB 67dB 100dB
RESIDUAL NOISE (8 ohms)	0.5mV
CHANNEL SEPARATION (IHF, 1kHz)	60dB
DAMPING FACTOR (1kHz, 8 ohms)	30
REQUIRED SPEAKER IMPEDANCE FOR USA, CANADA and EUROPE (EXCEPT UK and FRG)  FOR UK, FRG, AUSTRALIA and OTHER COUNTRIES	A or B: 6 to 16 ohms A and B: 12 to 16 ohms  A or B: 4 to 16 ohms A and B: 8 to 16 ohms

## PRE AMPLIFIER SECTION

### VIDEO SECTION

INPUT SENSITIVITY/IMPEDANCE VTR V. DISC	1Vp-p/75 ohms 1Vp-p/75 ohms
OUTPUT LEVEL/IMPEDANCE	1Vp-p/75 ohms

### AUDIO SECTION

INPUT SENSITIVITY/IMPEDANCE PHONO (MC) PHONO (MM) CD/AUX TUNER TAPE VTR (AUDIO) V. DISC (AUDIO)	0.2mV/100 ohms 2.0mV/47k ohms 150mV/47k ohms 150mV/47k ohms 150mV/47k ohms 150mV/47k ohms 150mV/47k ohms
OUTPUT LEVEL/IMPEDANCE TAPE REC	150mV/1k ohms
FREQUENCY RESPONSE PHONO (RIAA DEVIATION) TUNER, CD/AUX, TAPE	±0.2dB 5Hz to 100kHz (-3dB)
TONE CONTROL BASS TREBLE	±8dB ±8dB
SUBSONIC FILTER	-3dB (at 18Hz)
PHONO MAX. INPUT LEVEL MC MM	25mV 250mV
POWER REQUIREMENTS	120V, 60Hz for USA & Canada 220V, 50Hz for Europe except UK 240V, 50Hz for UK & Australia 110V/120V/220V/240V, 50Hz/60Hz convertible for other countries
DIMENSIONS	440(W) × 120(H) × 410(D)mm (17.3 × 4.7 × 16.1 inches)
WEIGHT	11.5kg (25.4 lbs)

\* For improvement purposes, specifications and design are subject to change without notice.

## II. DISMANTLING OF UNIT

In case of trouble, etc. necessitating dismantling, please dismantle in the order shown in the photographs. Reassemble in reverse order.

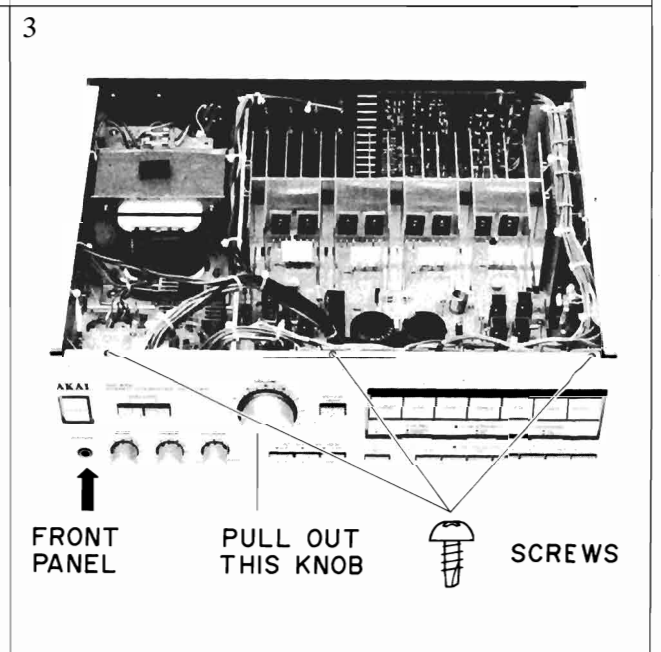
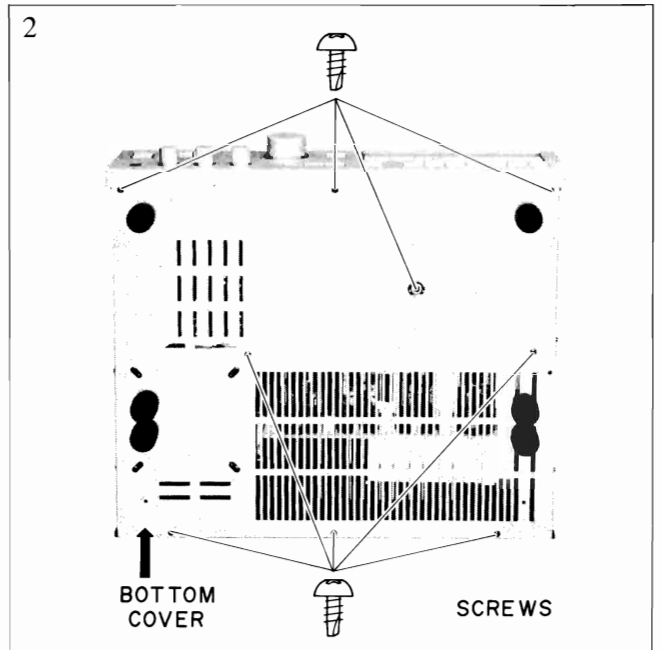
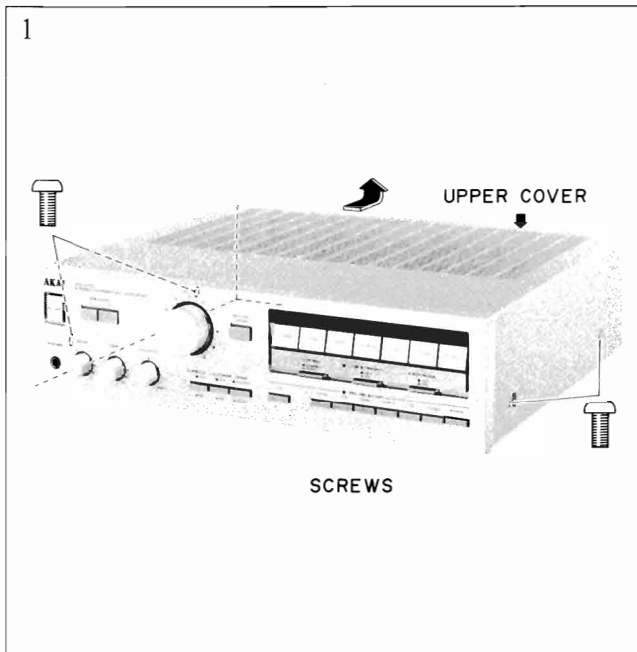

### III. CONTROLS

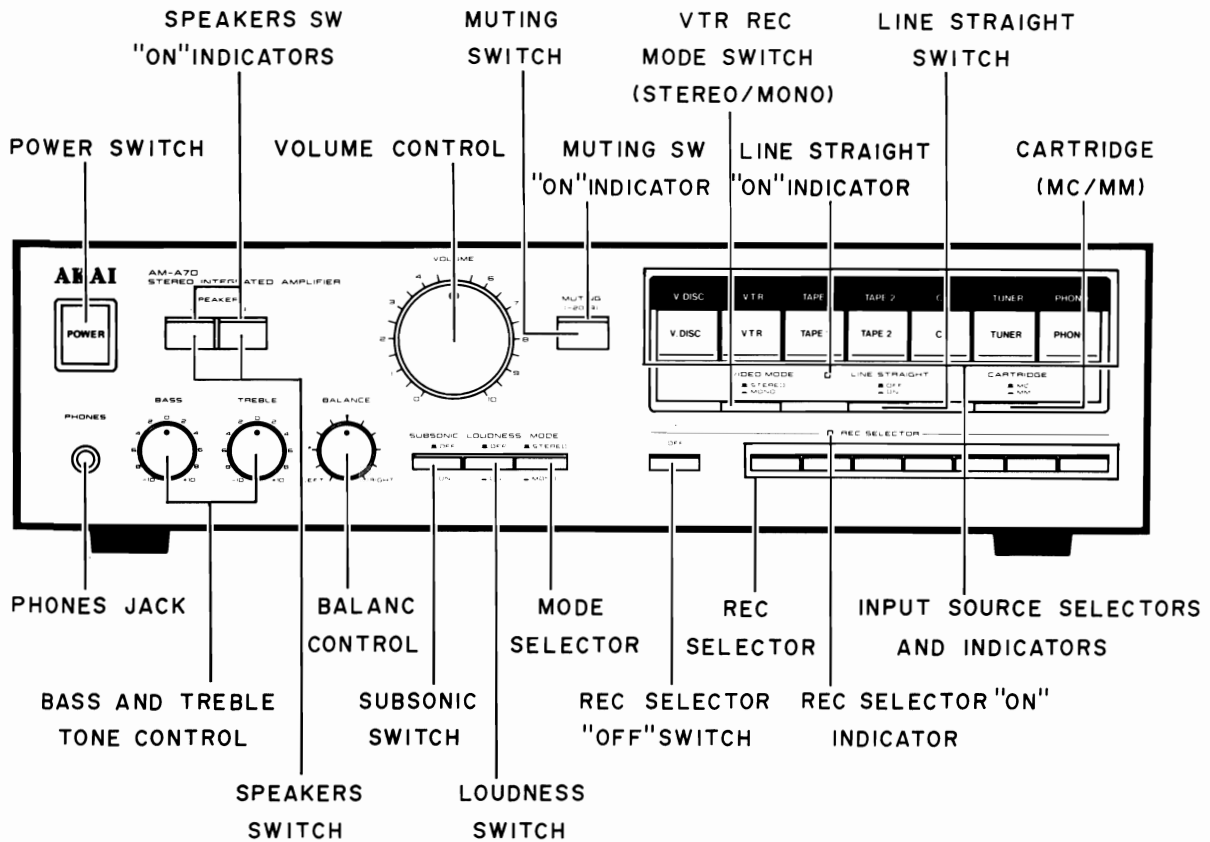

Fig. 3-1 Front View

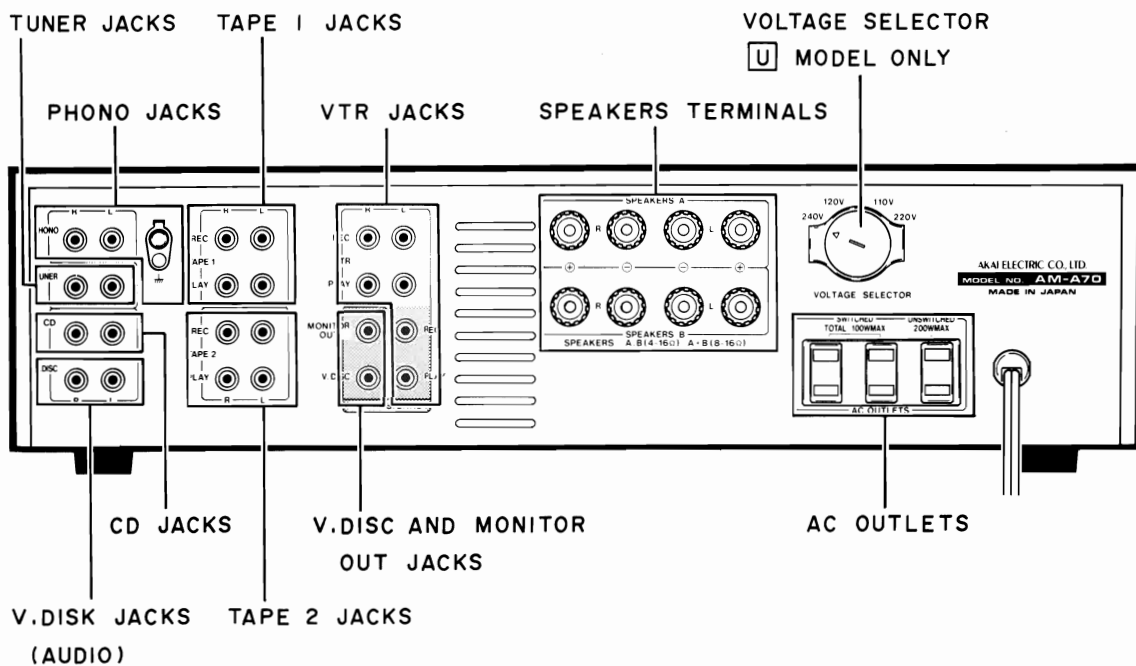

Fig. 3-2 Rear View



# IV. PRINCIPAL PARTS LOCATION

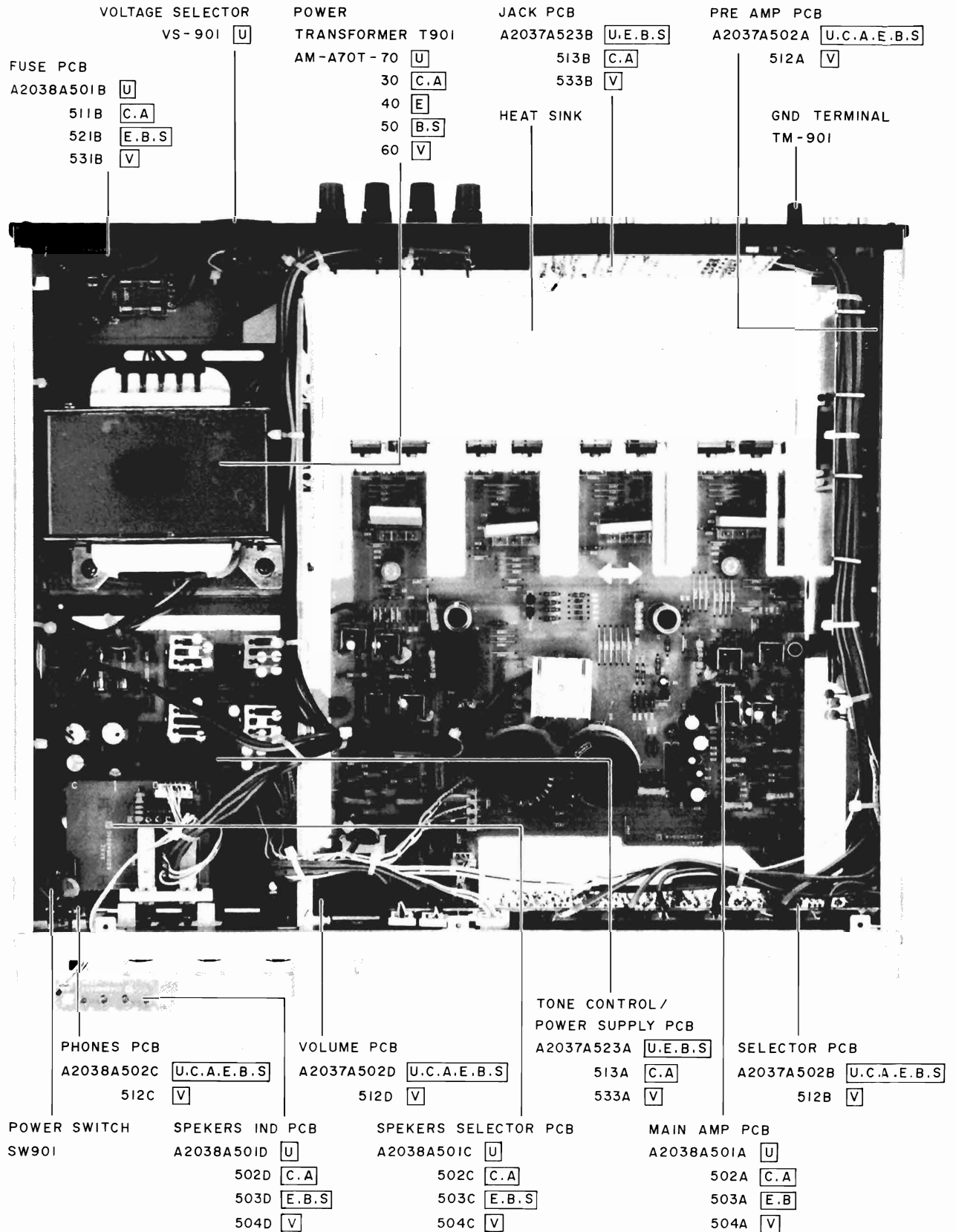

Fig. 4-1

## V. ADJUSTMENT

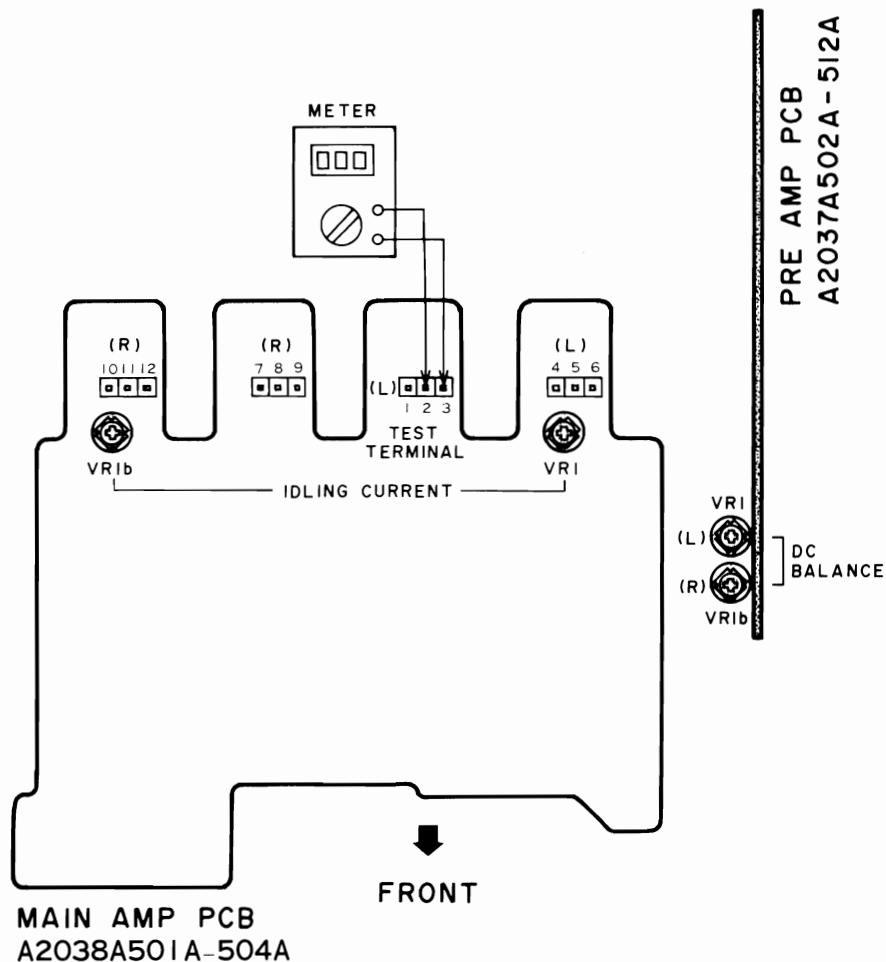

Fig. 5-1

### 5-1. EQ AMP DC BALANCE ADJUSTMENT

- 1) Set the REC SELECTOR to PHONO (MM) mode.
- 2) Connect an Oscilloscope to TAPE REC OUT.
- 3) Adjust VR1 (on EQUALIZER PCB) so that the DC Voltage is less than 1mV DC.
- 4) Adjust VR<sub>1b</sub> (R-ch) in the same manner as above.

### 5-2. IDLING CURRENT ADJUSTMENT

NOTE: This adjustment should be executed within 30 sec. after the power is turned on.

- 1) Connect a Digital Voltmeter DC range to the test terminal pin ① and ②, ② and ③, ④ and ⑤, ⑤ and ⑥ respectively, and measure the voltages (four voltages).
- 2) Connect the digital voltmeter to the test terminal in which the lowest voltage has been measured and adjust VR1 so that the voltage between the test terminal is 1.0mV DC.  
(The maximum voltage between these test terminal should be less than 2mV DC.)
- 3) Adjust VR<sub>1b</sub> (R-ch) in the same manner as above.  
(Use the test terminal pins ⑦ to ⑫ when measuring voltages for R-ch).

#### ATTENTION:

Precaution when replacing the power transistors (TR902 to TR905 and TR902b to TR905b). Make sure that to discharge the power supply voltage by connecting a resistor (100Ω/10W) between C13 pins (+ and -) and also between C12 pins (+ and -) after turn off the power for the safety and the protection of the transistors.

## VI. PC BOARD TITLE AND IDENTIFICATIONS

PC BOARD TITLE	PC BOARD	PC BOARD NUMBER	REMARKS
MAIN AMP	PC BOARD	A2038A501A	U
		502A	CA
		503A	EB
		504A	V
SELECTOR	PC BOARD	A2037A502B	UCAEBS
		512B	V
PRE AMP	PC BOARD	A2037A502A	UCAEBS
		512A	V
TONE CONTROL/POWER SUPPLY PC BOARD		A2037A523A	UEBS
		513A	CA
		533A	V
JACK	PC BOARD	A2037A523B	UEBS
		513B	CA
		533B	V
SPEAKERS SELECTOR	PC BOARD	A2038A501C	U
		502C	CA
		503C	EB S
		504C	V
SPEAKERS IND	PC BOARD	A2038A501D	U
		502D	CA
		503D	EB S
		504D	V
SPEAKERS TERMINAL	PC BOARD	A2018D5070	V
PHONES	PC BOARD	A2038A502C	UCAEBS
		512C	V
FUSE	PC BOARD	A2038A501B	U
		511B	CA
		521B	EB S
		531B	V
VOLUME	PC BOARD	A2037A502D	UCAEBS
		512D	V



---

SECTION 2

**PARTS LIST**

TABLE OF CONTENTS

RECOMMENDED SPARE PARTS .....	13
1. PC BOARD BLOCK .....	14
2. PRE AMP PC BOARD .....	14
3. TONE CONTROL/POWER SUPPLY PC BOARD .....	15
4. MAIN AMP PC BOARD .....	15
5. JACK PC BOARD .....	16
6. SELECTOR PC BOARD .....	16
7. SPEAKER SLECTOR PC BOARD .....	16
8. SPEAKER IND PC BOARD .....	16
9. VOLUME PC BOARD .....	16
10. HEAD PHONE PC BOARD .....	16
11. SPEAKER TERMINAL PC BOARD (V ONLY) .....	16
12. FUSE PC BOARD .....	16
13. ASSEMBLY BLOCK .....	16
14. FINAL ASSEMBLY BLOCK .....	18
15. INDEX .....	19

Resistor and Capacitor which is not listed in this parts list, please refer to COMMON LIST FOR SERVICE PARTS.

## ATTENTION

1. When placing an order for parts, be sure to list the parts no., model no., and description of each part. If any of this information is omitted, there are instances in which parts cannot be shipped or the wrong parts will be delivered.
2. Please be careful not to make a mistake in the parts no. If the parts no. is in error, a part different from the one ordered may be delivered.
3. Because part numbers and part definitions and supply in the Preliminary Parts List may have been the subject of changes, please use this parts list for all future reference.

## HOW TO USE THIS PARTS LIST

1. This Parts List shows those parts which are considered necessary for repairs. Other parts, such as resistors and capacitors, are shown in the "Common List for Service Parts" from which these parts should be selected and parts.
2. The Recommended Spare Parts List shows those parts in the Parts List which are considered particularly important for service.
3. Parts not shown in the Parts List and "Common List for Service Parts" will not in principle be supplied.
4. How to read the parts list
  - a) Mechanism Block
  - b) P.C Board Block

### 2. HEAD BASE BLOCK

REF. NO.	PART NO.	DESCRIPTION
2-1 <sup>x</sup>	BH-T2023A320A	HEAD BASE BLOCK GX-F66R
2-2	HP-H2206A010A	HEAD R/P PR4-8FU C
2-3	ZS-477876	PAN20×03STL CMT
2-4	ZS-536488	BID20×08STL CMT
2-5	ZG-402895	CS ANGLE ADJUST SPRING

SP (Service Parts) Classification

A small "x" indicates the inability to show that particular part in the Photo or Illustration.

This number corresponds with the individual parts index number in that figure

This number corresponds with the Figure Number

### 6. SYS. CON. P C BOARD BLOCK

REF. NO.	PART NO.	DESCRIPTION
6-1	BA-T2034A070A	PC SYS CON BLK GX-F44R
6-IC1	EI-324536	IC HD14049BP
6-IC2	EI-336801	IC MB8841-564M
6-IC3	EI-331661	IC SN7405N
6-IC4	EI-336725	IC M54527P
6-TR1to4	ET-200985	TR 2SC2603 F,G
6-TR5to28	ET-554657	TR 2SA733A P,Q
6-D1	ED-318292	D SILICON H 1S2473T-77 T26
6-D2to4	ED-308952	D GERMA V 1K34A-LR F07
6-D5to10	ED-318292	D SILICON H 1S2473T-77 T26
6-X1	EI-318384	OSC X'TAL NC-18C 3.579545MHZ

SP (Service Parts) Classification

These reference symbols correspond with component symbols in the Schematic Diagrams.

5. The kind of part and its installation position can both be determined by the Part Number. To determine where a part number is listed, utilize the Parts Index at the end of the Parts List. It is necessary first of all to find the Part Number. This can be accomplished by using the Reference Number listed at the right of the part number in the Parts Index.

## WARNING

**△ INDICATES SAFETY CRITICAL COMPONENTS. FOR CONTINUED SAFETY, REPLACE SAFETY CRITICAL COMPONENTS ONLY WITH MANUFACTURE'S RECOMMENDED PARTS**

## AVERTISSEMENT

**△ IL INDIQUE LES COMPOSANTS CRITIQUES DE SÉCURITÉ. POUR MAINTENIR LE DEGRÉ DE SÉCURITÉ DE L'APPAREIL, NE REMPLACER QUE DES PIÈCES RECOMMANDÉES PAR LE FABRICANT**

## RECOMMENDED SPARE PARTS

Because, if the parts listed below are on hand, almost any repair can be accomplished, we suggest that you stock these Recommended Spare Parts Items.

REF. NO.	PART NO.	DESCRIPTION
1 N	BT-355409	△ TRANS POWER AM-A70T-30 (C,A)
2 N	BT-355411	△ TRANS POWER AM-A70T-40 (E)
3 N	BT-355412	△ TRANS POWER AM-A70T-50 (B,S)
4 N	BT-361998	△ TRANS POWER AM-A70T-60 (V)
5 N	BT-355408	△ TRANS POWER AM-A70T-70 (U)
6 N	ED-355425	D LED BG-5725-B7- GREEN
7	ED-356424	D LED BG5525S GREEN
8	ED-354114	D LED BR5507S RED
9 N	ED-355426	D LED PR-5705S-B7 RED
10	ED-345555	D SILICON DBB10C 200/1.0A
11	ED-348990	D SILICON H DS446
12	ED-301911	D SILICON H DS448
13 N	ED-355437	D SILICON PB-102F
14	ED-348786	D SILICON RB154 400/1.5A
15	ED-310387	D ZNEER H HZ12 B2
16	ED-328486	D ZENER H HZ15 3
17	ED-315759	D ZENER H HZ16 1
18	ED-324013	D ZENER H HZ20 2
19	ED-332336	D ZENER H HZ20 3
20	ED-329051	D ZENER H HZ24 3
21	ED-346619	D ZENER H HZ27 1
22	ED-346603	D ZENER H HZ6 A1
23 N	EF-355226	△ FUSE BET T 1.00A 250V [B]
24 N	EF-359086	△ FUSE BET T 4.00A 250V [B]
25	EF-623103	△ FUSE SEMKO T 1.00A 250V [U,E,V,S]
26	EF-690996	△ FUSE SEMKO T 4.00A 250V [U]
27	EF-309392	△ FUSE TSC 125V 1.25A [C,A]
28	EF-345658	△ FUSE TSC 125V 8.00A [C,A]
29	EI-345474	△ IC HA12002
30	EI-355697	△ IC M5221P
31	EI-344764	IC M5218P-21
32 N	EL-355435	PL LEAD 14.3V 80 MA
33 N	EQ-359532	△ RELAY POWER G5R2282P DC12V
34 N	EQ-355458	△ RELAY SIG G2Q-187P-V 12V
35	EQ-348929	△ RELAY SIG G5A-232P 2TR 12V
36	ER-345616	△ R CT W R33+R33 5W
37 N	ES-355407	△ SW PUSH ESB-99713V TV-8
38	ES-345481	△ SW PUSH SPEA12089A 04-2N
39	ES-349070	△ SW SELECTOR YKS11-0002 02-4 [U]
40	ES-348841	SW PUSH SPEA12090A 04-2S
41 N	ES-355417	SW PUSH SPEA71 7 THROW
42 N	ES-355418	SW PUSH SPEA84 8 THROW
43	ES-355429	SW PUSH SPUJ34
44 N	ES-355433	SW PUSH SPUL241
45	ET-348856	△ TR 2SA1106 O,Y
46	ET-348857	△ TR 2SC2581 O,Y
47	ET-355782	△ TR 2SD1247 T,U
48 N	ET-360750	TR FET 2SJ74 BL
49	ET-321016	TR FET 2SK117 GR,BL
50 N	ET-360749	TR FET 2SK170 BL
51 N	ET-359827	TR FET 2SK246 BL
52	ET-337759	TR FET 2SK246 GR
53	ET-348829	TR 2SA1209 S,T
54	ET-348834	TR 2SA1220 Q,P
55	ET-345626	TR 2SA1248 S,T
56	ET-355626	TR 2SA992 E,F
57	ET-347143	TR 2SC1845 E,F
58	ET-308141	TR 2SC2603 G
59	ET-348835	TR 2SC2690 Q,P
60	ET-348830	TR 2SC2909 S,T
61	ET-348831	TR 2SC2911 S,T
62	ET-345625	TR 2SC3116 S,T
63	ET-349081	TR 2SC3383 S,T
64	ET-310148	TR 2SD612K E,F
65	EV-380204	R S-FIX H SR19R 3P 0.15W 102
66	EV-338118	R S-FIX V H1052A 3P 0.15W 104
67 N	EV-355456	VR ROTARY RKDA10 105
68 N	EV-355457	VR ROTARY RKDA2S 100KCX2

REF. PART NO. DESCRIPTION  
NO.

69 N EV-355466 VR ROTARY RKDA20 100KCX2  
70 N EV-355427 VR ROTARY RKGA20-250KBX2

“NOTE” N: New Parts

### SYMBOL FOR DESTINATION

[A] : AAL (USA)  
[B] : UK (ENGLAND)  
[C] : CSA (CANADA)  
[E] : CEE (EUROPE)  
[S] : SAA (AUSTRALIA)  
[U] : U/T (UNIVERSAL AREA)  
[V] : VDE (WEST GERMANY)

## 1. PC BOARD BLOCK

REF. NO.	PART NO.	DESCRIPTION
1-1A	BA-A2037A020A	PC PRE BLK AM-A90 (U,C,A,E,B,S)
1-1B	BA-A2037A020B	PC PRE BLK AM-A90 (V)
1-2A	BA-A2037A040C	PC TONE BLK AM-A70 (U,E,B,S)
1-2B	BA-A2037A040F	PC TONE BLK AM-A70 (C,A)
1-2C	BA-A2037A040D	PC TONE BLK AM-A70 (V)
1-3A	BA-A2038A030A	PC MAIN BLK AM-A70 (U)
1-3B	BA-A2038A030B	PC MAIN BLK AM-A70 (C,A)
1-3C	BA-A2038A030C	PC MAIN BLK AM-A70 (E,B,S)
1-3D	BA-A2038A030D	PC MAIN BLK AM-A70 (V)

### NOTE:

- (1) PC PRE BLK consists of following PC BOARDS.
  - PRE AMP PC BOARD
  - SELECTOR PC BOARD
  - VOLUME PC BOARD
  - HEAD PHONE PC BOARD
- (2) PC TONE BLK consists of following PC BOARDS.  
TONE CONTROL/POWER SUPPLY PC BOARD  
JACK PC BOARD
- (3) PC MAIN BLK consists of following PC BOARDS.
  - MAIN AMP PC BOARD
  - SPEAKER SELECTOR PC BOARD
  - SPEAKER IND PC BOARD
  - FUSE PC BOARD

## 2. PRE AMP PC BOARD

REF. NO.	PART NO.	DESCRIPTION
2-IC1	EI-355697	IC M5221P
2-TR1	ET-360749	TR FET 2SK170 BL
2-TR2	ET-360750	TR FET 2SJ74 BL
2-TR3	ET-345625	△ TR 2SC3116 S,T
2-TR4	ET-345626	△ TR 2SA1248 S,T
2-TR5	ET-355626	TR 2SA992 E,F
2-TR6	ET-347143	TR 2SC1845 E,F
2-T R7	ET-348834	TR 2SA1220 Q,P
2-TR8	ET-348835	TR 2SC2690 Q,P
2-TR9	ET-348831	TR 2SC2911 S,T
2-TR10	ET-348829	TR 2SA1209 S,T
2-D2	ED-328486	D ZENER H HZ15 3
2-D3	ED-328486	D ZENER H HZ15 3
2-D4	ED-348990	D SILICON H DS446
2-D5	ED-348990	D SILICON H DS446
2-D6	ED-348990	D SILICON H DS446
2-D7	ED-348990	D SILICON H DS446
2-VR1	EV-338118	R S-FIX V H1052A 3P 0.15W 104
2-L1	EO-337684	COIL FIX 2 FL12R571E 751K [V]
2-RL1	EQ-348929	RELAY SIG G5A-232P 2TR 12V
2-R1	ER-311766	R MF H 1/4W 4702F
2-R5	RE-359825	△ R OMF H S20 FS 2W 621J
2-R8	ER-359825	△ R OMF H S20 FS 2W 621J
2-R27	ER-359508	R MF H 1/4W 5103G
2-R28	ER-359509	R MF H 1/4W 4703G
2-R29	ER-359510	R MF H 1/4W 5602G
2-R30	ER-359511	R MF H 1/4W 3302G
2-R31	ER-359512	R MF H 1/4W 5102G
2-R32	ER-359513	R MF H 1/4W 4702G
2-R33	ER-359514	R MF H 1/4W 5601G
2-R34	ER-359516	R MF H 1/4W 3301G
2-R43	ER-359524	△ R OMF H S20 FS 2W 362J
2-R46	ER-359524	△ R OMF H S20 FS 2W 362J
2-R47	ER-338187	R MF H 1/4W 153J
2-R48	ER-338187	R MF H 1/4W 153J
2-C1A	EC-349083	△ C STY V CUT CQ09S2B 101J 125DC [EXCEPT V]
2-C1B	EC-350675	C STY V CUT CQ09S2B 331J 125DC [V]
2-C2	EC-350745	△ C STY V CUT CQ09S2B 102J 125DC
2-C3	EC-355434	△ C MY V MKT 105K 100DC
2-C4	EC-343892	△ C PP V F05 FPS 1302G 100DC
2-C5	EC-359530	C PP V F05 PP 3601G 50DC
2-C6	EC-343917	△ C PP V F07 FPS 1303G 100DC
2-C7	EC-359531	C PP V F05 PP 3602G 50DC
2-C8	EC-345656	C PP V F05 PP 473J 50DC
2-J1	EJ-337404	PIN J AJC-052-ABB P 6P
2-J2	EJ-337424	PIN J AJC-034-ABB P 2P

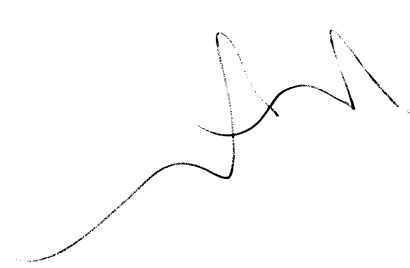



### 3. TONE CONTROL/POWER SUPPLY PC BOARD

REF. NO.	PART NO.	DESCRIPTION
<b>TONE CONTROL/POWER SUPPLY PC BOARD</b>		
3-IC1	EI-344764	IC M5218P-21
3-TR1	ET-337759	TR FET 2SK246 GR
3-TR2	ET-337759	TR FET 2SK246 GR
3-TR3	ET-345625	△ TR 2SC3116 S,T
3-TR4	ET-345626	△ TR 2SA1248 S,T
3-TR5	ET-337759	TR FET 2SK246 GR
3-TR6	ET-337759	TR FET 2SK246 GR
3-TR7	ET-345625	△ TR 2SC3116 S,T
3-TR8	ET-345626	△ TR 2SA1248 S,T
3-TR9	ET-310148	△ TR 2SD612K E,F
3-TR10	ET-359827	TR FET 2SK246 BL
3-D1	ED-348786	△ D SILICON RB154 400/1.5A
3-D2	ED-346619	△ D ZENER H HZ27 1
3-D3	ED-346619	△ D ZENER H HZ27 1
3-D4	ED-346619	△ D ZENER H HZ27 1
3-D5	ED-346619	△ D ZENER H HZ27 1
3-D6	ED-315759	△ D ZENER H HZ16 1
3-D7	ED-315759	△ D ZENER H HZ16 1
3-D8	ED-329051	△ D ZENER H HZ24 3
3-D9	ED-329051	△ D ZENER H HZ24 3
3-D10	ED-329051	△ D ZENER H HZ24 3
3-D11	ED-329051	△ D ZENER H HZ24 3
3-D12	ED-345555	△ D SILICON DBB10C 200/1.0A
3-D13	ED-310387	△ D ZENER H HZ12 B2
3-D14	ED-332336	△ D ZENER H HZ20 3
3-VR1	EV-355456	VR ROTARY RKDA10 105
3-VR2	EV-355457	VR ROTARY RKDA2S 100KCX2
3-VR3	EV-355466	VR ROTARY RKDA20 100KCX2
3-R18	ER-324184	△ R CB H S10 FS RDS 1/4W 121J
3-R19	ER-359823	△ R MF H 1/4W 203J
3-R20	ER-359823	R MF H 1/4W 203J
3-R21	ER-324184	△ R CB H S10 FS RDS 1/4W 121J
3-R22	ER-359826	△ R OMF H S20 FS 2W 302J
3-R23	ER-359826	△ R OMF H S20 FS 2W 302J
3-R24	ER-324184	△ R CB H S10 FS RDS 1/4W 121J
3-R25	ER-311766	R MF H 1/4W 4702F
3-R26	ER-346929	R MF H 1/4W 473J
3-R27	ER-324184	△ R CB H S10 FS RDS 1/4W 121J
3-R29	ER-324184	△ R CB H S10 FS RDZ 1/4W 121J
3-R30	ER-359824	△ R OMF H S20 FS 2W 822J
3-C8	EC-201639	C EC V CUT SM 331M 80DC
3-C9	EC-201639	C EC V CUT SM 331M 80DC

#### ASSEMBLY BLOCK

3-F3A	EF-309392	△ FUSE TSC 125V 1.25A [C,A]
3-F3B	EF-623103	△ FUSE SEMKO T 1.00A 250V [U,E,B,S]
3-F3C	EF-355226	△ FUSE BET T 1.00A 250V [B]
3-F4A	EF-309392	△ FUSE TSC 125V 1.25A [C,A]
3-F4B	EF-623103	△ FUSE SEMKO T 1.00A 250V [U,E,V,S]
3-F4C	EF-355226	△ FUSE BET T 1.00A 250V [B]
3-F5A	EF-310229	△ FUSE TSC 125V 1.00A [C,A]
3-F5B	EF-623103	△ FUSE SEMKO T 1.00A 250V [U,E,V,S]
3-F5C	EF-355226	△ FUSE BET T 1.00A 250V [B]

### 4. MAIN AMP PC BOARD

REF. NO.	PART NO.	DESCRIPTION
4-IC1	EI-355697	△ IC M5221P
4-IC2	EI-345474	△ IC HA12002
4-TR1	ET-321016	TR FET 2SK117 GR,BL
4-TR2	ET-348835	TR 2SC2690 G,P
4-TR3	ET-348834	TR 2SA1220 Q,P
4-TR4	ET-348830	TR 2SC2909 S,T
4-TR5	ET-348830	TR 2SC2909 S,T
4-TR6	ET-348829	△ TR 2SA1209 S,T
4-TR7	ET-348831	△ TR 2SC2911 S,T
4-TR8	ET-348831	△ TR 2SC2911 S,T
4-TR9	ET-348829	△ TR 2SA1209 S,T
4-TR10	ET-348830	TR 2SC2909 S,T
4-TR11	ET-348830	TR 2SC2909 S,T
4-TR12	ER-338244	TR 2SA1207 RS
4-D1	ED-324013	D ZENER H HZ20 2
4-D2	ED-324013	D ZENER H HZ20 2
4-D3	ED-348990	D SILICON H DS446
4-D4	ED-346613	D ZENER H HZ11 C3
4-D5	ED-346613	D ZENER H HZ11 C3
4-D6	ED-348990	D SILICON H DS446
4-D7	ED-346603	D ZENER H HZ6 A1
4-D8		to 12
4-D9	ED-301911	D SILICON H DS448
4-D13	ED-355437	△ D SILICON PB-102F
4-D14	ED-348990	D SILICON H DS446
4-D15	ED-348990	D SILICON H DS446
4-D16	ED-301911	D SILICON H DS448
4-SW1	ES-355429	SW PUSH SPUJ34
4-VR1	EV-380204	R S-FIX H SR19R 3P 0.15W 102
4-L1	EO-332116	COIL FIX 2 103AK-006A 2R2K
4-RL1	EQ-359532	RELAY POWER G5R2282P DC 12V
4-R4A	ER-362240	R MF H 1/4W 105J [EXCEPT V]
4-R4B	ER-338183	R MF H 1/4W 104J [V]
4-R5	ER-359521	△ R OMF H S20 FS 2W 332J
4-R8	ER-359521	△ R OMF H S20 FS 2W 332J
4-R9	ER-311760	R MF H 1/4W 1802F
4-R10	ER-311760	△ R MF H 1/4W 1802F
4-R15	ER-341331	△ R OMF H S15 FS 1W 181J
4-R16	ER-341331	△ R OMF H S15 FS 1W 181J
4-R21	ER-333429	△ R CB H S10 FS RDS 1/4W 682J
4-R22	ER-333429	△ R CB H S10 FS RDS 1/4W 682J
4-R24	ER-325638	△ R OMF H S15 FS 1W 271J
4-R27	ER-325638	△ R OMF H S15 FS 1W 271J
4-R30	ER-322787	△ R CB H S10 FS RDS 1/4W 100J
4-R31	ER-322787	△ R CB H S10 FS RDS 1/4W 100J
4-R32	ER-333398	△ R CB H S10 FS RDS 1/4W 302J
4-R33		to 36
4-R34	ER-333372	△ R CB H S10 FS RDS 1/4W 150J
4-R37	ER-327197	△ R CB H S10 FS RDS 1/4W 391J
4-R38	ER-345616	△ R CT W R33+R33 5W
4-R39	ER-345616	△ R CT W R33+R33 5W
4-R50	ER-359520	△ R OMF H S20 FS 2W 120J
4-R52	ER-359520	△ R OMF H S20 FS 2W 120J
4-R65	ER-359521	△ R OMF H S20 FS 2W 332J
4-R68	ER-359823	R MF H 1/4W 203J
4-R70	ER-338187	R MF H 1/4W 153J
4-C1	EC-344155	C PP V F05 PP 181J 50DC
4-C2	EC-345655	C PP V F05 PP 223J 50DC
4-C3A	EC-362238	C PP V F05 PP 203J 50DC [EXCEPT V]
4-C3B	EC-359525	C PP V F05 PP 823J 50DC [V]
4-C4	EC-359829	C PP V F05 PP 151J 50DC
4-C5	EC-345656	C PP V F05 PP 473J 50DC
4-C9	EC-355461	C MY V MKT 334K 100DC
4-C12	EC-355460	C EC V SNP 103M 63.0DC
4-C13	EC-355460	C EC V SNP 103M 63.0DC

## 5. JACK PC BOARD

REF. NO.	PART NO.	DESCRIPTION
5-TR1	ET-308141	TR 2SC2603 G
5-TR2	ET-308141	TR 2SC2603 G
5-TR3	ET-308141	△ TR 2SC2603 G
5-TR4	ET-308141	△ TR 2SC2603 G
5-RL1	EQ-355458	RELAY SIG G2Q-187P-V 12V
5-R8	ER-324337	△ R CB H S10 FS RDS 1/4W 560J
5-R17	ER-322591	△ R CB H S10 FS RDS 1/4W 101J
5-R18	ER-322591	△ R CB H S10 FS RDS 1/4W 101J
5-J3 to 5	EJ-336915	PIN J AJC-054-ABB P 4P
5-J6	EJ-355459	PIN J YKC21-0157 P 4P

## 6. SELECTOR PC BOARD

REF. NO.	PART NO.	DESCRIPTION
6-TR1 to 3	ET-349081	TR 2SC3383 S,T
6-D1	ED-354114	D LED BR5507S RED
6-D2	ED-355425	D LED BG-5725-B7 GREEN
6-D3	ED-355426	D LED PR-5705S-B7 RED
6-SW1	ES-355417	SW PUSH SPEA71 7 THROW
6-SW2	ES-355418	SW PUSH SPEA84 8 THROW
6-SW3	ES-348841	SW PUSH SPEA12090A 04-2S
6-SW4	ES-345481	SW PUSH SPEA12089A 04-2N
6-SW5	ES-348841	SW PUSH SPEA12090A 04-2S
6-SW6	ES-345481	SW PUSH SPEA12089A 04-2N
6-IN1 to 7	EL-355435	PL LEAD 14.3V 80MA

## 7. SPEAKER SELECTOR PC BOARD

REF. NO.	PART NO.	DESCRIPTION
7-SW1	ES-355433	SW PUSH SPUL241
7-R1	ER-306416	△ R OMF H S20 FS 2W 271J
7-R2	ER-306416	△ R OMF H S20 FS 2W 271J

## 8. SPEAKER IND PC BOARD

REF. NO.	PART NO.	DESCRIPTION
8-D1 to 4	ED-356424	D LED BG5525S GREEN

## 9. VOLUME PC BOARD

REF. NO.	PART NO.	DESCRIPTION
9-VR1	EV-355427	VR ROTARY RKA20-250KBX2

## 10. HEAD PHONE PC BOARD

REF. NO.	PART NO.	DESCRIPTION
10-R1	ER-557583	△ R OMF H FS 2W 431J
10-J19	EJ-348846	PHONE J 3P HLJ0540 6.3

## 11. SPEAKER TERMINAL PC BOARD (V ONLY)

REF. NO.	PART NO.	DESCRIPTION
11-TM902	EJ-342935	TERMINAL W/SCREW YKD31-0132 P 8P [V]

## 12. FUSE PC BOARD

REF. NO.	PART NO.	DESCRIPTION
<b>FUSE PC BOARD</b>		
12-L1	EO-338409	COIL LF FK0B160MH02 250UH [V]
<b>ASSEMBLY BLOCK</b>		
12-F1A	EF-690996	△ FUSE SEMKO T 4.00A 250V [U]
12-F1B	EF-345658	△ FUSE TSC 125V 8.00A [C,A]
12-F1C	EF-690996	△ FUSE SEMKO T 4.00A 250V [E,V,S]
12-F1D	EF-359086	△ FUSE BET T 4.00A 250V [B]
12-F2	EF-690996	△ FUSE SEMKO T 4.00A 250V [U]

## 13. ASSEMBLY BLOCK

REF. NO.	PART NO.	DESCRIPTION
<b>ASSEMBLY BLOCK</b>		
13-1A	SP-358664A	PANEL REAR AM-A70 (U)
13-1B	SP-358664B	PANEL REAR AM-A70 (A,C)
13-1C	SP-358664C	PANEL REAR AM-A70 (E)
13-1D	SP-358664D	PANEL RERR AM-A70 (B,S)
13-1E	SP-358664J	PANEL REAR AM-A70 (V)
13-2	EJ-329610	TERMIANL W/SCREW UB-0067 L 1P
13-3	ZS-319460	T2BR30×06STL BZN PROJECTION
13-4	EZ-345459	TRANSISTOR SUPPORT BFG-20T0-3P
13-5A	EW-374894	△ AC CORD 2 CORES VM-0129A, VFF U/T [U]
13-5B	EW-349427	△ AC CORD 2 CORES KP-8W, SPT-2 UC [C,A]
13-5C	EW-347897	△ AC CORD 2 CORES VM0364, LCFL EV [E,V]
13-5D	EW-346249	△ AC CORD 2 CORES LCFL2×0.75 B [B]
13-5E	EW-338517	△ AC CORD KP-560, LTSA-2F S [S]
13-6	EZ-631945	STRAIN RELIEF SR-4N-4
13-7	ZS-345624	ST PAN40×08STL CMT CUP [POWER TRANS FIX]
13-8	SA-312465	FOOT CIRCULAR (A) PART CA
13-9	ZS-325495	T2BR30×06STL CMT [FOOT FIX]
13-10	ZS-345436B	SCREW TRANSISTOR (B)
13-T901ABT-355408		△ TRANS POWER AM-A70T-70 (U)
13-T901BBT-355409		△ TRANS POWER AM-A70T-30 (C,A)
13-T901CBT-355411		△ TRANS POWER AM-A70T-40 (E)
13-T901DBT-355412		△ TRANS POWER AM-A70T-50 (B,S)
13-T901EBT-361998		△ TRANS POWER AM-A70T-60 (V)
13-TR901ET-355782		△ TR 2SD1247 T,U
13-TR902ET-348857		△ TR 2SC2581 O,Y
13-TR903ET-348857		△ TR 2SC2581 O,Y
13-TR904ET-348856		△ TR 2SA1106 O,Y
13-TR905ET-348856		△ TR 2SA1106 O,Y
13-VS901ES-349070		△ SW SELECTOR YKS11-0002 02-4 [U]
13-SW901ES-355407		△ SW PUSH ESB-99713V TV-8
13-J901A EJ-337405		△ SOCKET OUTLET S2T733T164 JU C 3×2P [U]
13-J901B EJ-352642		△ SOCKET OUTLET S2T733T114T [C,A]
13-TM902A EJ-337406		△ TERMINAL W/SCREW ANB-024.A AA S 8P [U,C,A,E,B,S]
13-TM902B EJ-342935		△ TERMINAL W/SCREW YKD31-0132 P 8P [V]
13-C901A EC-320548		△ C CE V F 103Z 250AC [U]
13-C901B EC-338411		△ C CE V FZ 103P 400AC [C,A,E,B,V,S]

### PRE AMP PC BOARD

2-J1	EJ-337404	PIN J AJC-052-ABB P 6P
2-J2	EJ-337424	PIN J AJC-034-ABB P 2P

### JACK PC BOARD

5-J3	EJ-336915	PIN J AJC-054-ABB P 4P
5-J4	EJ-336915	PIN J AJC-054-ABB P 4P
5-J5	EJ-336915	PIN J AJC-054-ABB P 4P
5-J6	EJ-355459	PIN J YKC21-0157 P 4P

ASSEMBLY BLOCK

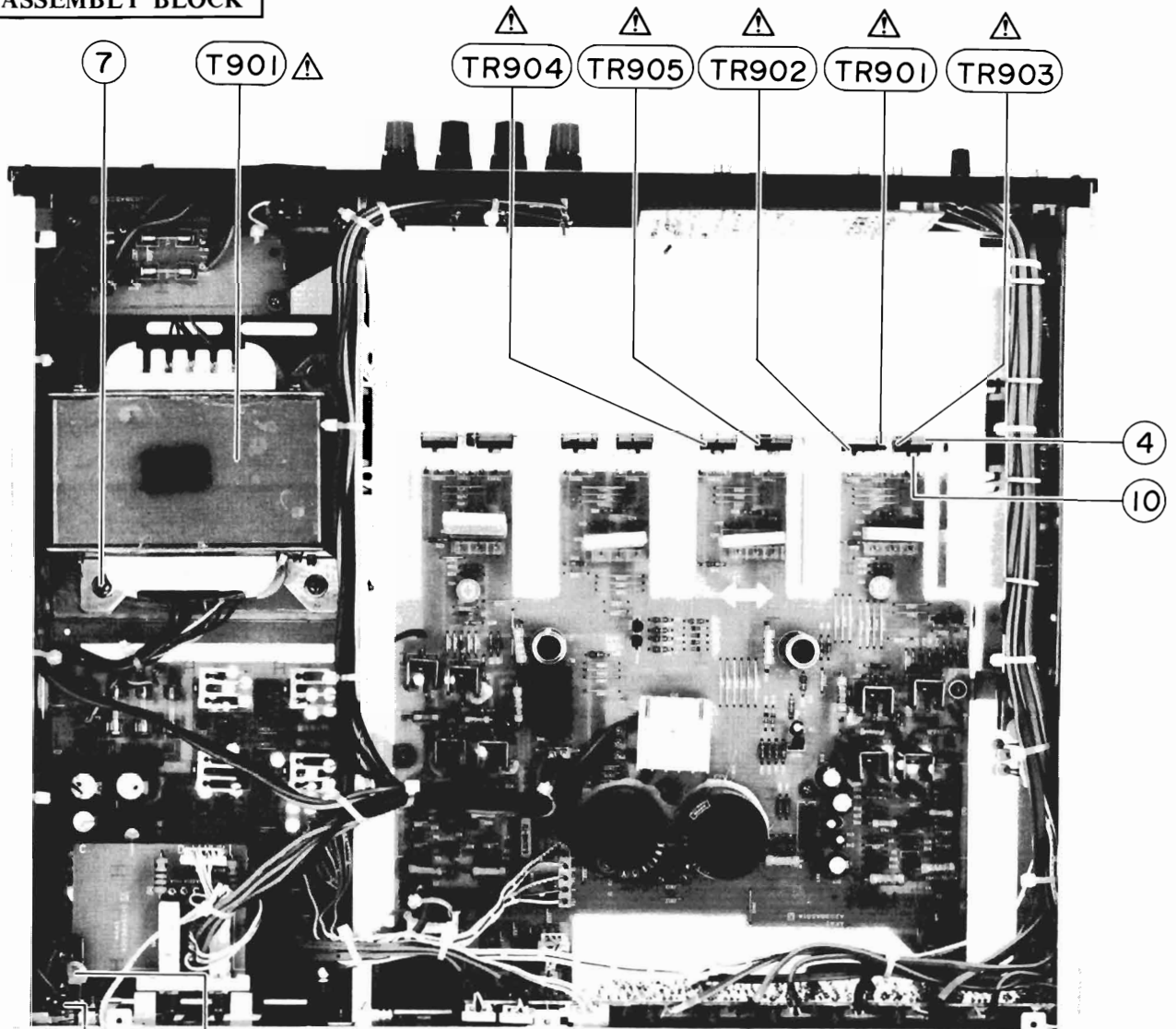

SW901 C901

2-J1 2 3 5-J3 5-J5

TM902

VS901

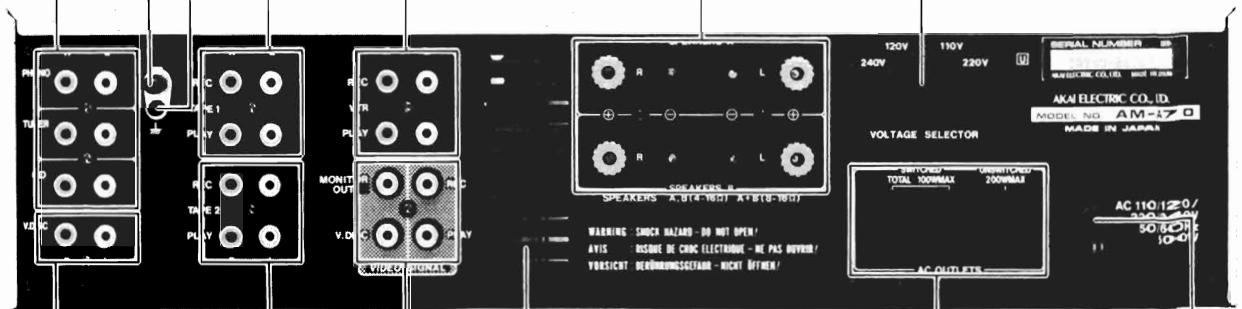

2-J2 9 8 5-J4 5-J6 1

J901 5 6

PARTS LIST

## FINAL ASSEMBLY BLOCK

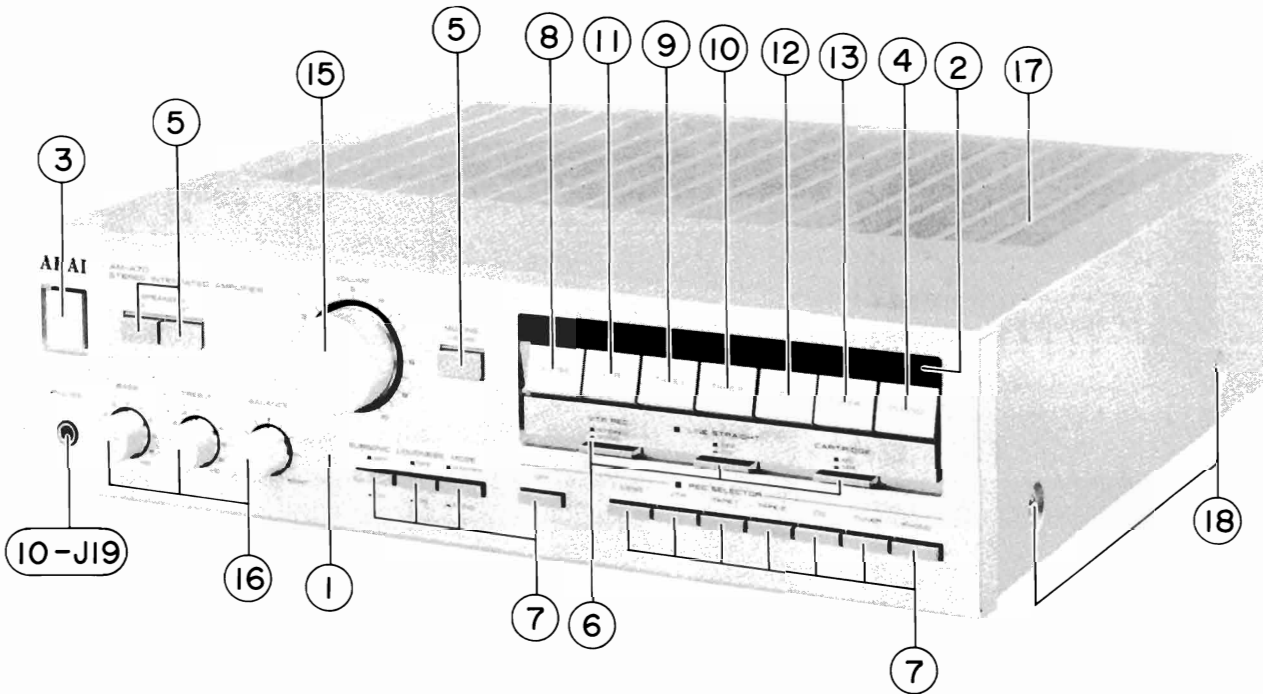

### 14. FINAL ASSEMBLY BLOCK

REF. NO.	PART NO.	DESCRIPTION
14-1	BD-A2037A060B	PANEL FRONT BLK AM-A70
14-1B	BD-A2037A060D	PANEL FRONT BLK AM-A70-B
14-2	SE-358656	WINDOW FILTER
14-3	SK-345231A	CAP POWER
14-3B	SK-345231C	CAP POWER-B
14-4	SK-B358655A7	KNOB PUSH (D-13) PART (PHONO)
14-4B	SK-B358655B7	KNOB PUSH (D-14) B PART (PHONO-B)
14-5	SK-358649A	KNOB PUSH (A)
14-5B	SK-358649B	KNOB PUSH (A)-B
14-6	SK-358651A	KNOB PUSH (B)
14-6B	SK-358651B	KNOB PUSH (B)-B
14-7	SK-358653A	KNOB PUSH (C)
14-7B	SK-358653B	KNOB PUSH (C)-B
14-8	SK-B358655A1	KNOB PUSH (D-1) PART (V, DISC)
14-8B	SK-B358655B1	KNOB PUSH (D-2) B PART (V, DISC-B)
14-9	SK-B358655A2	KNOB PUSH (D-3) PART (TAPE 1)
14-9B	SK-B358655B2	KNOB PUSH (D-4) B PART (TAPE 1-B)
14-10	SK-B358655A3	KNOB PUSH (D-5) PART (TAPE 2)
14-10B	SK-B358655B3	KNOB PUSH (D-6) B PART (TAPE 2-B)
14-11	SK-B358655A4	KNOB PUSH (D-7) PART (VTR)
14-11B	SK-B358655B4	KNOB PUSH (D-8) B PART (VTR-B)
14-12	SK-B358655A5	KNOB PUSH (D-9) PART (CD)
14-12B	SK-B358655B5	KNOB PUSH (D-10) B PART (CD-B)

REF. NO.	PART NO.	DESCRIPTION
14-13	SK-B358655A6	KNOB PUSH (D-11) PART (TUNER)
14-13B	SK-B358655B6	KNOB PUSH (D-12) B PART (TUNER-B)

#### FINAL ASSEMBLY BLOCK

14-14x	ZS-447840	T2BR30x08STL CMT [PANEL FRONT FIX]
14-15	SK-358657A	KNOB MAIN VOLUME
14-15B	SK-358657B	KNOB MAIN VOLUME-B
14-16	SK-358658A	KNOB VOLUME
14-16B	SK-358658B	KNOB VOLUME-B
14-17	SP-358673A	COVER UPPER
14-17B	SP-358673B	COVER UPPER-B
14-18	ZS-322570	ST BID40x08STL NI3 [COVER UPPER FIX]
14-18B	ZS-322580	ST BID40x08STL BNI [COVER UPPER FIX]

#### HEAD PHONE PC BOARD

10-J19	EJ-348846	PHONE J 3P HJ0540 6.3
--------	-----------	-----------------------

#### NOTE:

PANEL FRONT BLK consists of 14-2 to 14-13B.

#### SYMBOL FOR COLOR VARIATION

NON : STANDARD COLOR

B : BLACK

# INDEX

PART NO.	REF. NO.	PART NO.	REF. NO.	PART NO.	REF. NO.	PART NO.	REF. NO.	PART NO.	REF. NO.
BA-A2037A020A	1-1A	EF-345658	12-F1B	ER-359521	4-R5	SE-358656	14-2		
BA-A2037A020B	1-1B	EF-355226	3-F3C	ER-359521	4-R8	SK-B358655A1	14-8		
BA-A2037A040C	1-2A	EF-355226	3-F4C	ER-359521	4-R65	SK-B358655A2	14-9		
BA-A2037A040D	1-2C	EF-355226	3-F5C	ER-359524	2-R43	SK-B358655A3	14-10		
BA-A2037A040F	1-2B	EF-359086	12-F1D	ER-359524	2-R46	SK-B358655A4	14-11		
BA-A2038A030A	1-3A	EF-623103	3-F3B	ER-359823	3-R19	SK-B358655A5	14-12		
BA-A2038A030B	1-3B	EF-623103	3-F4B	ER-359823	3-R20	SK-B358655A6	14-13		
BA-A2038A030C	1-3C	EF-623103	3-F5B	ER-359823	4-R68	SK-B358655A7	14-4		
BA-A2038A030D	1-3D	EF-690996	12-F1A	ER-359824	3-R30	SK-B358655B1	14-8B		
BD-A2037A060B	14-1	EF-690996	12-F1C	ER-359825	2-R8	SK-B358655B2	14-9B		
BD-A2037A006D	14-1B	EF-690996	12-F2	ER-359825	2-R5	SK-B358655B3	14-10B		
BT-355408	13-T901A	EI-344764	3-IC1	ER-359826	3-R22	SK-B358655B4	14-11B		
BT-355409	13-T901B	EI-345474	4-IC2	ER-359826	3-R23	SK-B358655B5	14-12B		
BT-355411	13-T901C	EI-355697	2-IC1	ER-362240	4-R4A	SK-B358655B6	14-13B		
BT-355412	13-T901D	EI-355697	4-IC1	ER-557583	10-R1	SK-B358655B7	14-4B		
BT-361998	13-T901E	EJ-329610	13-2	ES-345481	6-SW4	SK-345231A	14-3		
EC-201639	3-C8	EJ-336915	5-J3	ES-345481	6-SW6	SK-345231C	14-3B		
EC-201639	3-C9	EJ-336915	5-J4	ES-348841	6-SW3	SK-358649A	14-5		
EC-320548	13-C901A	EJ-336915	5-J5	ES-348841	6-SW5	SK-358649B	14-5B		
EC-338411	13-C901B	EJ-337404	2-J1	ES-349070	13-VS901	SK-358651A	14-6		
EC-343892	2-C4	EJ-337405	13-J901A	ES-355407	13-SW901	SK-358651B	14-6B		
EC-343917	2-C6	EJ-337406	13-TM902A	ES-355417	6-SW1	SK-358653A	14-7		
EC-344155	4-C1	EJ-337424	2-J2	ES-355418	6-SW2	SK-358653B	14-7B		
EC-345655	4-C2	EJ-342935	11-TM902	ES-355429	4-SW1	SK-358657A	14-15		
EC-345656	2-C8	EJ-342935	13-TM902B	ES-355433	7-SW1	SK-358657B	14-15B		
EC-345656	4-C5	EJ-348846	10-J19	ET-308141	5-TR1	SK-358658A	14-16		
EC-349083	2-C1A	EJ-352642	13-J901B		to 4	SK-358658B	14-16B		
EC-350675	2-C1B	EJ-355459	5-J6	ET-310148	3-TR9	SP-358664A	13-1A		
EC-350745	2-C2	EL-355435	6-IN1	ET-321016	4-TR1	SP-358664B	13-1B		
EC-355434	2-C3		to 7	ET-337759	3-TR1	SP-358664C	13-1C		
EC-355460	4-C12	EO-332116	4-L1	ET-337759	3-TR2	SP-358664D	13-1D		
EC-355460	4-C13	EO-337684	2-L1	ET-337759	3-TR5	SP-358664J	13-1E		
EC-355461	4-C9	EO-338409	12-L1	ET-337759	3-TR6	SP-358673A	14-17		
EC-359525	4-C3B	EQ-348929	2-RL1	ET-345625	2-TR3	SP-358673B	14-17B		
EC-359530	2-C5	EQ-355458	5-RL1	ET-345625	3-TR3	ZS-319460	13-3		
EC-359531	2-C7	EQ-359532	4-RL1	ET-345625	3-TR7	ZS-322570	14-18		
EC-359829	4-C4	ER-306416	7-R1	ET-345626	2-TR4	ZS-322580	14-18B		
EC-362238	4-C3A	ER-306416	7-R2	ET-345626	3-TR8	ZS-325495	13-9		
ED-301911	4-D10	ER-311760	4-R9	ET-345626	3-TR4	ZS-345436B	13-10		
ED-301911	4-D8	ER-311760	4-R10	ET-347143	2-TR6	ZS-345624	13-7		
ED-301911	4-C11	ER-311766	2-R1	ET-348829	2-TR10	ZS-447840	14-14x		
ED-301911	4-D9	ER-311766	3-R25	ET-348829	4-TR6				
ED-301911	4-D12	ER-322591	5-R17	ET-348829	4-TR9				
ED-301911	4-D16	ER-322591	5-R18	ET-348830	4-TR4				
ED-310387	3-D13	ER-322787	4-R30	ET-348830	4-TR5				
ED-315759	3-D6	ER-322787	4-R31	ET-348830	4-TR10				
ED-315759	3-D7	ER-324184	3-R18	ET-348830	4-TR11				
ED-324013	4-D1	ER-324184	3-R21	ET-348831	2-TR9				
ED-324013	4-D2	ER-324184	3-R24	ET-348831	4-TR7				
ED-328486	2-D2	ER-324184	3-R27	ET-348831	4-TR8				
ED-328486	2-D3	ER-324184	3-R29	ET-348834	2-TR7				
ED-329051	3-D8	ER-324337	5-R8	ET-348834	4-TR3				
ED-329051	3-D9	ER-325638	4-R24	ET-348835	2-TR8				
ED-329051	3-D11	ER-325638	4-R27	ET-348835	4-TR2				
ED-329051	3-D10	ER-327197	4-R37	ET-348856	13-TR904				
ED-332336	3-D14	ER-333372	4-R33	ET-348856	13-TR905				
ED-345555	3-D12		to 36	ET-348857	13-TR902				
ED-346603	4-D7	ER-333398	4-R32	ET-348857	13-TR903				
ED-346613	4-D5	ER-333429	4-R21	ET-349081	6-TR1				
ED-346613	4-D4	ER-333429	4-R22	ET-349081	6-TR2				
ED-346619	3-D2	ER-338183	4-R4B	ET-349081	6-TR3				
	to 5	ER-338187	2-R47	ET-355626	2-TR5				
ED-348786	3-D1	ER-338187	2-R48	ET-355782	13-TR901				
ED-348990	2-D4	ER-338187	4-R70	ET-359827	3-TR10				
	to 7	ER-338224	4-TR12	ET-360749	2-TR1				
ED-348990	4-D14	ER-341331	4-R15	ET-360750	2-TR2				
ED-348990	4-D15	ER-341331	4-R16	EV-338118	2-VR1				
ED-348990	4-D3	ER-345616	4-R38	EV-355427	9-VR1				
ED-348990	4-D6	ER-345616	4-R39	EV-355456	3-VR1				
ED-354114	6-D1	ER-346929	3-R26	EV-355457	3-VR2				
ED-355425	6-D2	ER-359508	2-R27	EV-355466	3-VR3				
ED-355426	6-D3	ER-359509	2-R28	EV-380204	4-VR1				
ED-355437	4-D13	ER-359510	2-R29	EW-338517	13-5E				
ED-356424	8-D1	ER-359511	2-R30	EW-346249	13-5D				
ED-356424	8-D2	ER-359512	2-R31	EW-347897	13-5C				
ED-356424	8-D3	ER-359513	2-R32	EW-349427	13-5B				
ED-356424	8-D4	ER-359514	2-R33	EW-374894	13-5A				
EF-309392	3-F3A	ER-359516	2-R34	EZ-345459	13-4				
EF-309392	3-F4A	ER-359520	4-R50	EZ-631945	13-6				
EF-310229	3-F5A	ER-359520	4-R52	SA-312465	13-8				

# AKAI

## SCHEMATIC DIAGRAM AND PC BOARDS

### MODEL AM-A70

#### LOCATION OF COMPONENTS

- TRs  
 TR1.....2C  
 TR2.....2D  
 TR3.....1C  
 TR4.....2C  
 TR6.....2E  
 TR7.....1D  
 TR8.....2D  
 TR9.....3E  
 TR10....3E

- IC  
 IC1.....1F

- CONNECTORS  
 W301....1E  
 W302....1E  
 W303....1E  
 W304....2F  
 W305....1F  
 W308....1E  
 W309....1E  
 W310....1F

- TR1, 2, 5, 6.....2SK246 (GR)  
 TR3, 7.....2SC3116 (S.T)  
 TR4, 8.....2SA1248 (S.T)  
 TR9.....2SD612K (E.F)  
 TR10.....2SK246 (BL)



2SK246

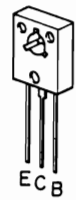

2SA1248  
 2SC3116  
 2SD612K

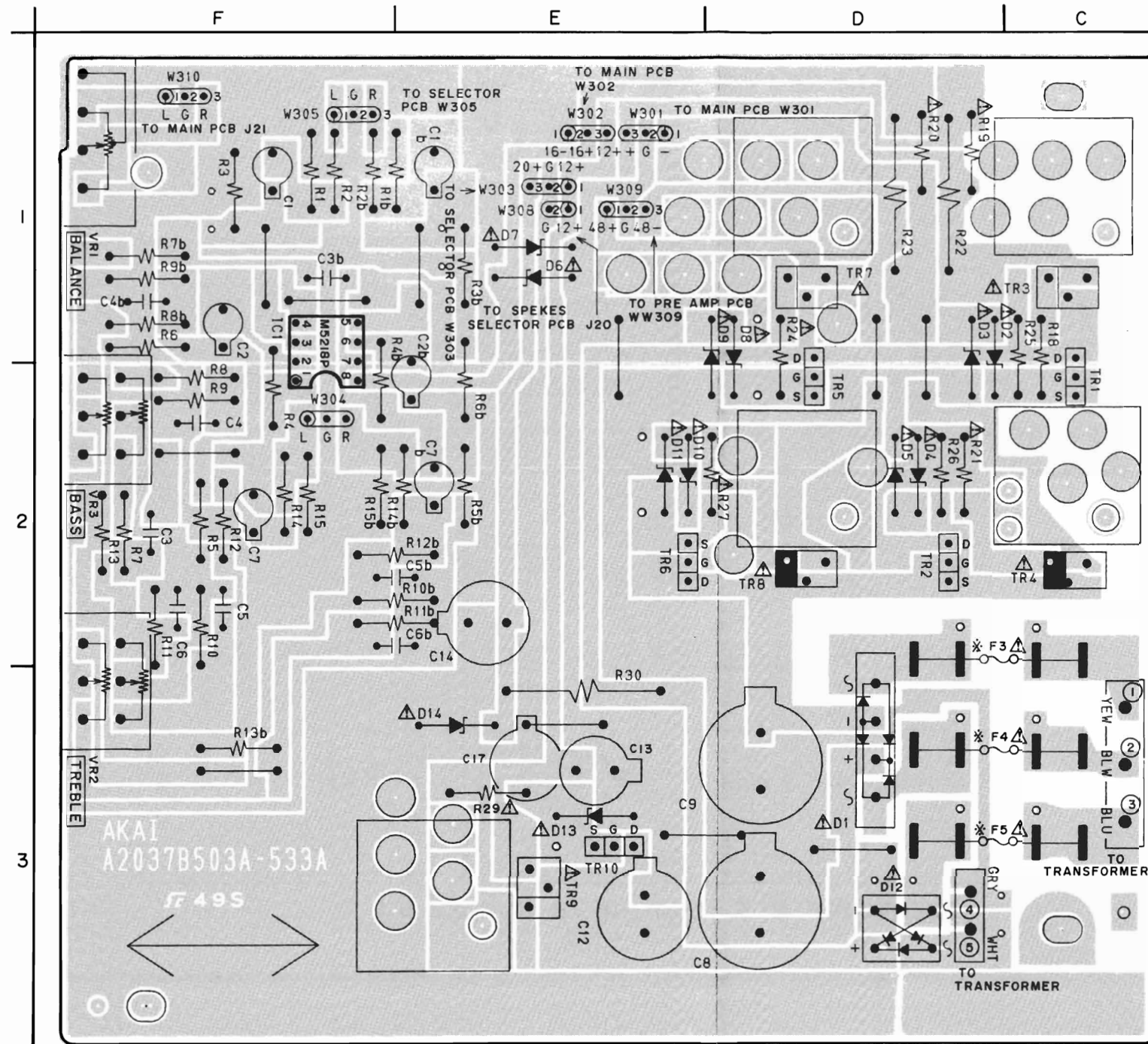

TONE CONTROL/POWER SUPPLY PCB A2037B523A

U.E.B.S  
 513A C.A  
 533A V

*	C.A	U.E.V.S	B
F3	1.25A 125V	T1A 250V	T1A 250V
F4	1.25A 125V	T1A 250V	T1A 250V
F5	1A 125V	T1A 250V	T1A 250V

- = NPN TRANSISTOR  
 = PNP TRANSISTOR  
 = FILED EFFECT TRANSISTOR

WARNING: INDICATES SAFETY CRITICAL COMPONENTS. FOR CONTINUED SAFETY, REPLACE SAFETY CRITICAL COMPONENTS ONLY WITH MANUFACTURER'S RECOMMENDED PARTS.

AVERTISSEMENT: IL INDIQUE LES COMPOSANTS CRITIQUES DE SÉCURITÉ. POUR MAINTENIR LE DEGRÉ DE SÉCURITÉ DE L'APPAREIL, NE REMPLACER QUE DES PIÈCES RECOMMANDÉES PAR LE FABRICANT.

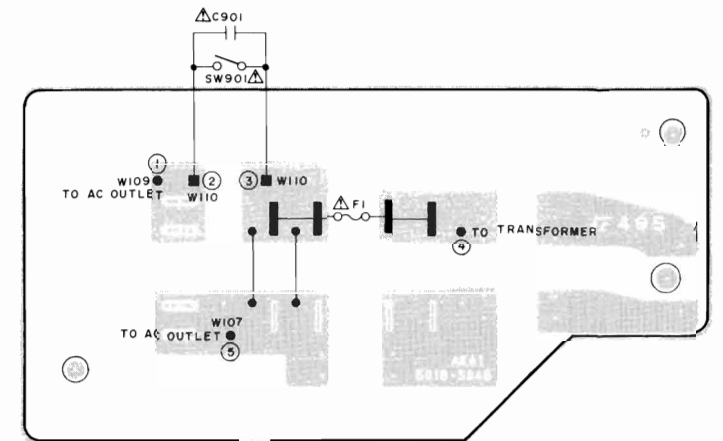

FUSE PCB A2038A502B C.A

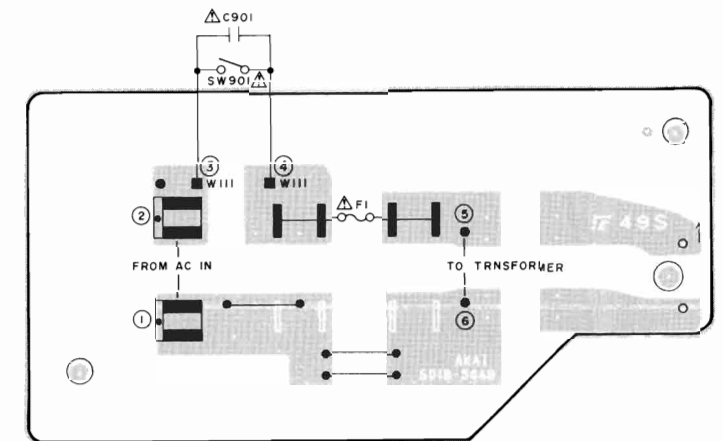

FUSE PCB A2038A503B E.B.S

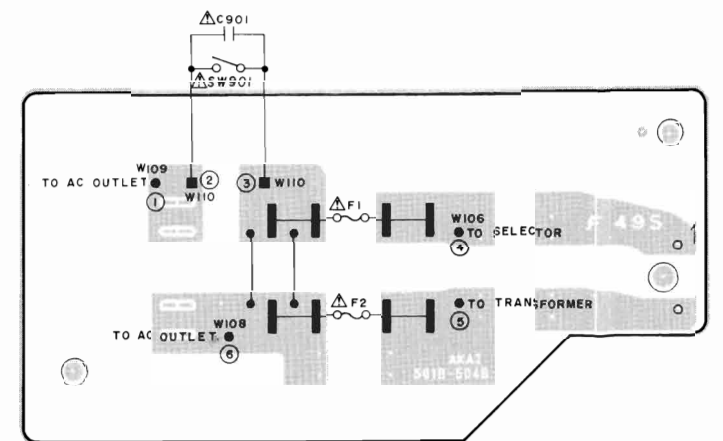

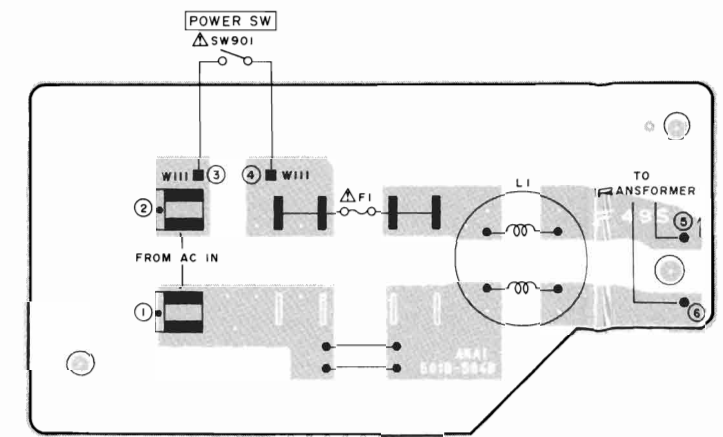

FUSE PCB A2038A501B U

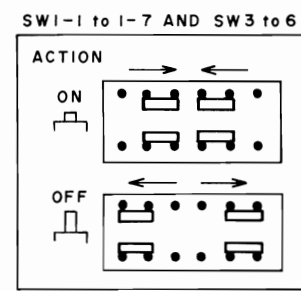
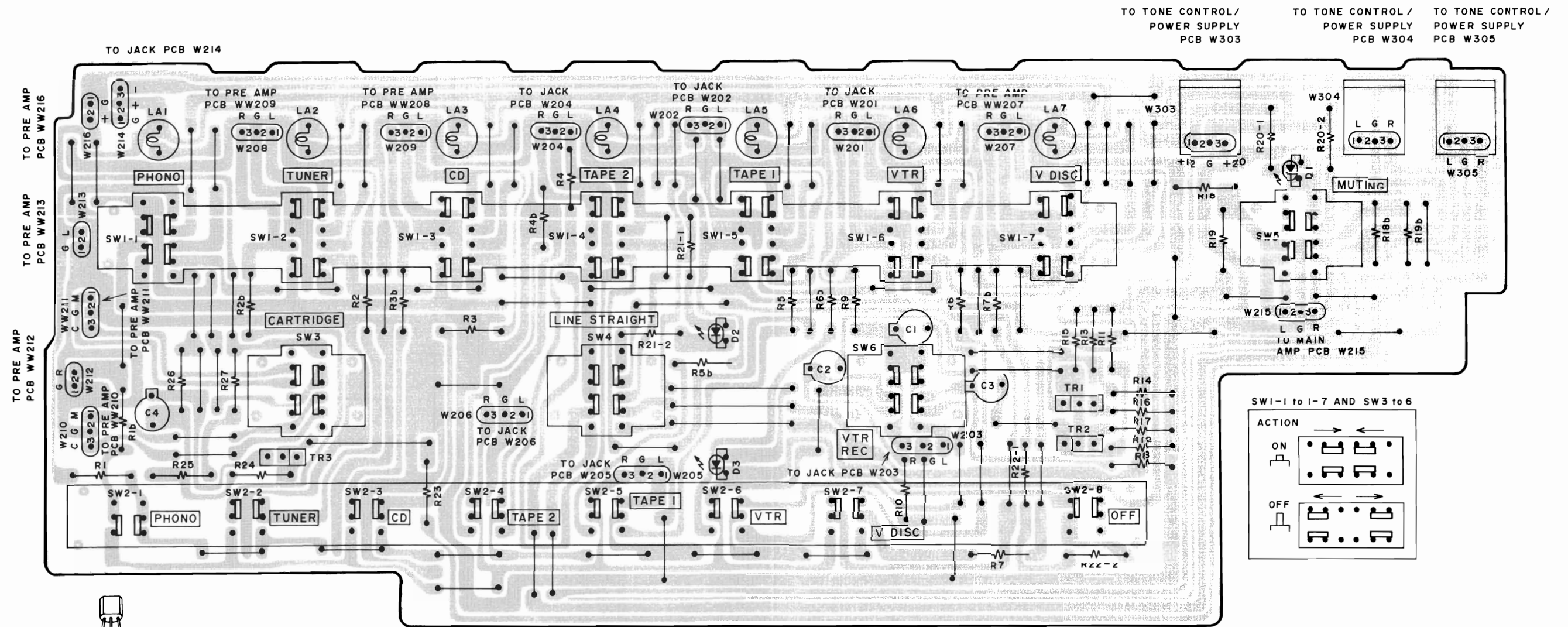

FUSE PCB A2038A504B V



 ECB  
 25C3383

 TRI to 3 ---- 25C3383

 = NPN TRANSISTOR

SELECTOR PCB A2037A502B U.C.A.E.B.S  
 512B V

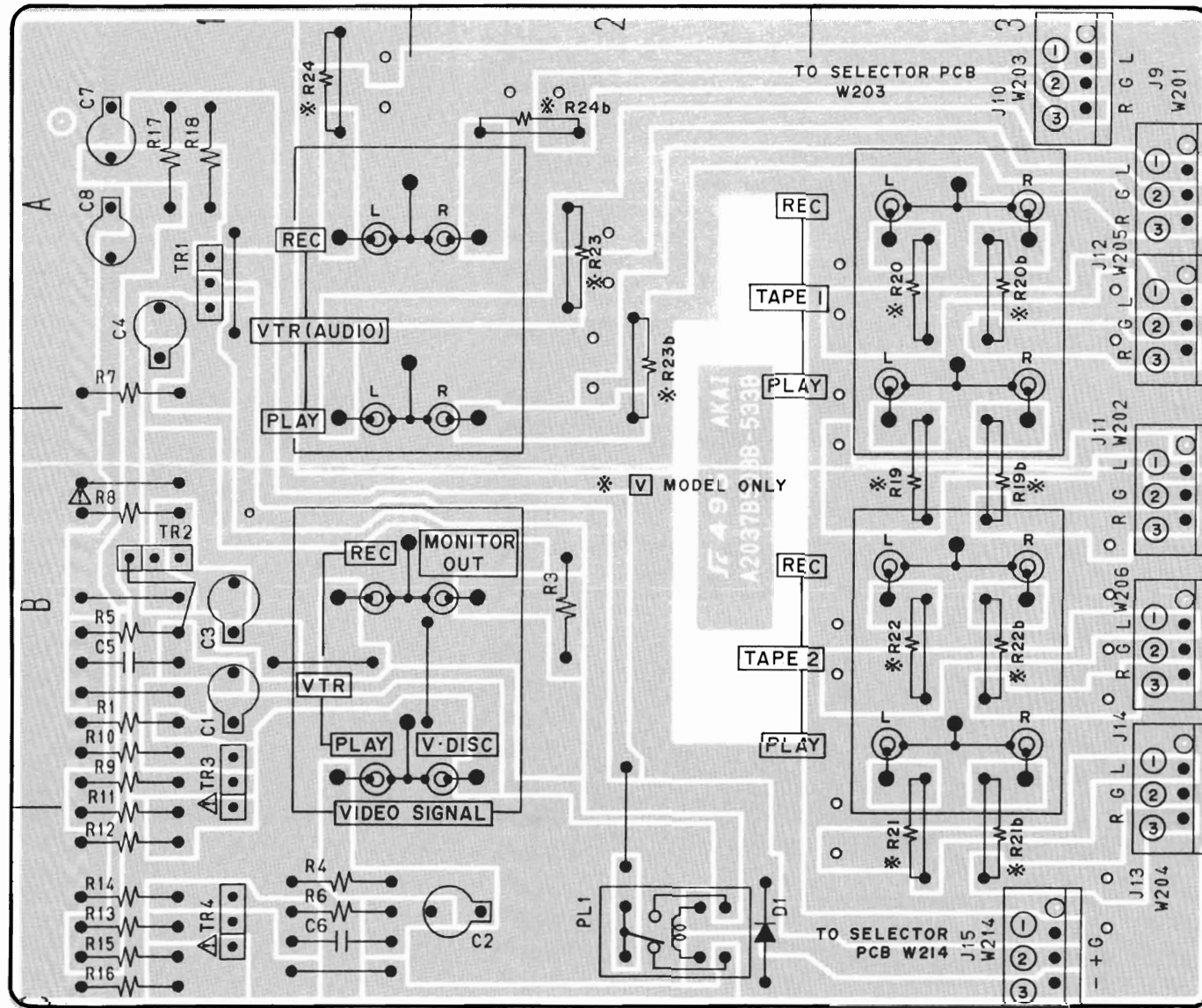

••• = NPN TRANSISTOR  
 B  
 TR, S  
 TR1 to 4 ---- 2SC603(E.F)



JACK PCB A2037B523B U.E.B.S  
 513B C.A  
 533B V

WARNING: ⚠ INDICATES SAFETY CRITICAL COMPONENTS. FOR CONTINUED SAFETY, REPLACE SAFETY CRITICAL COMPONENTS ONLY WITH MANUFACTURER'S RECOMMENDED PARTS.  
 AVERTISSEMENT: ⚠ IL INDIQUE LES COMPOSANTS CRITIQUES DE SÉCURITÉ. POUR MAINTENIR LE DEGRÉ DE SÉCURITÉ DE L'APPAREIL, NE REMPLACER QUE DES PIÈCES RECOMMANDÉES PAR LE FABRICANT

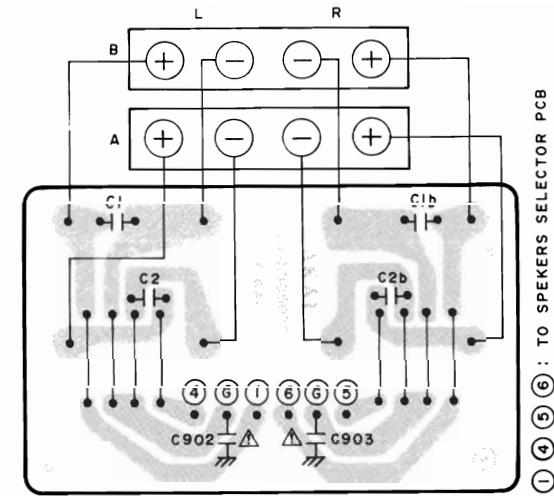

SPEAKERS TERMINAL PCB  
 A2018D5070 V MODEL ONLY

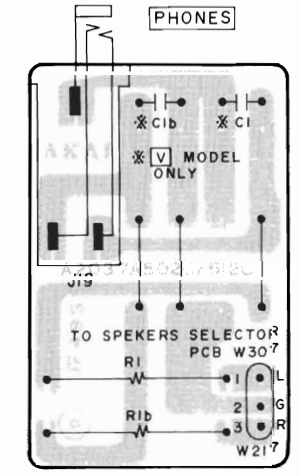

PHONES PCB  
 A2037A502C U.C.A.E.B.S  
 A2037A512C V

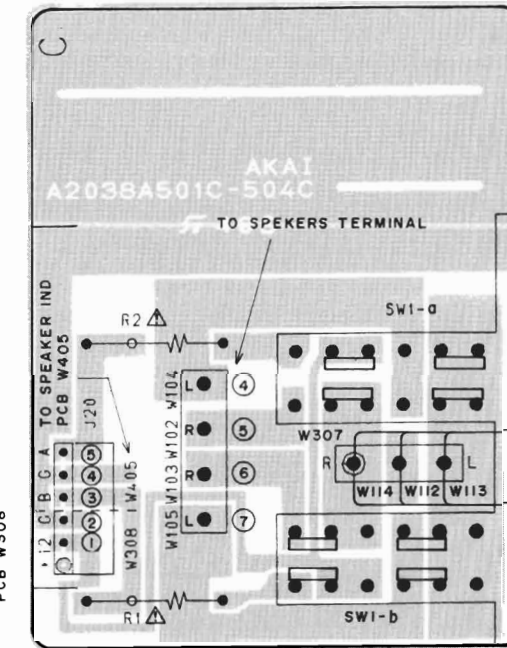

SPEAKERS SELECTOR PCB  
 A2038A501C U  
 A2038A502C C.A  
 A2038A503C E.B.S  
 A2038A504C V

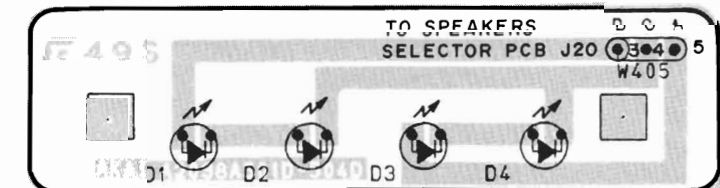

SPEAKERS IND PCB  
 A2038A501D U  
 A2038A502D C.A  
 A2038A503D E.B.S  
 A2038A504D V



LOCATION OF COMPONENTS

- TRs  
 TR1.....2SK117(Y)  
 TR2.....2SC2960(GR)  
 TR3.....2SA1220(Q,P)  
 TR4,5,10,11.....2SC2909(S,T)  
 TR6,9.....2SC1209(S,T)  
 TR7,8.....2SC2911(S,T)  
 TR901.....2SD1247(Y,U)  
 TR902,903.....2SC2581(O,Y)  
 TR904,905.....2SA1106(O,Y)  
 TR12.....2SA1207(Y)

- TRs  
 TR1.....3E  
 TR1b.....3A  
 TR2.....3E  
 TR2b.....3A  
 TR3.....3E  
 TR3b.....3A  
 TR4.....3E  
 TR4b.....3A  
 TR5.....3E  
 TR5b.....3A  
 TR6.....4E  
 TR6b.....4A  
 TR7.....4E  
 TR7b.....4A  
 TR8.....5E  
 TR8b.....5A  
 TR9.....4E  
 TR9b.....4A  
 TR10.....5E  
 TR10b.....5B  
 TR11.....5E  
 TR11b.....5B  
 TR12.....4D  
 TR901.....6E  
 TR901b.....6A  
 TR902.....6D  
 TR902b.....6A  
 TR903.....6E  
 TR903b.....6A  
 TR904.....6C  
 TR904b.....6B  
 TR905.....6D  
 TR905b.....6B

- ICs  
 IC1.....3B  
 IC2.....3D

- CONNECTORS  
 W111.....4B  
 W112.....2C  
 W113.....4B  
 W114.....4B  
 W301.....2B  
 W302.....3B  
 W401.....2A  
 J7.....2B  
 J21.....2A

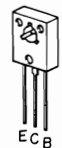

2SA1209  
2SC2911

2SA1106  
2SC2581



2SC2960

2SK117

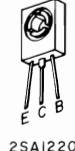

2SD1247

2SA1220

2SA1207

2SC2909

- = NPN TRANSISTOR
- = PNP TRANSISTOR
- = FILED EFFECT TRANSISTOR

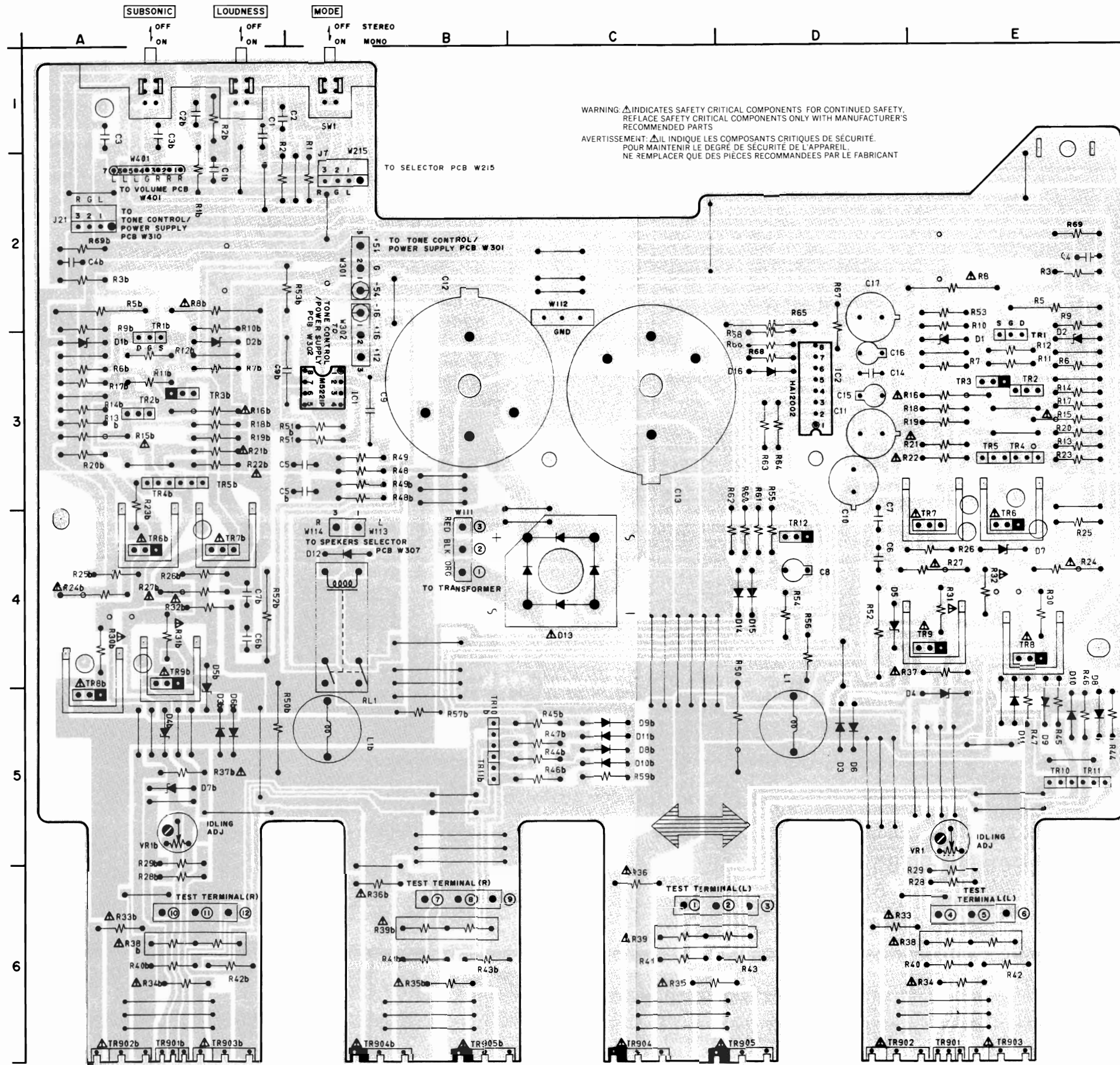

WARNING: INDICATES SAFETY CRITICAL COMPONENTS. FOR CONTINUED SAFETY, REPLACE SAFETY CRITICAL COMPONENTS ONLY WITH MANUFACTURER'S RECOMMENDED PARTS.  
 AVERTISSEMENT: IL INDIQUE LES COMPOSANTS CRITIQUES DE SECURITE. POUR MAINTENIR LE DEGRE DE SECURITE DE L'APPAREIL, NE REMPLACER QUE DES PIECES RECOMMANDEES PAR LE FABRICANT.

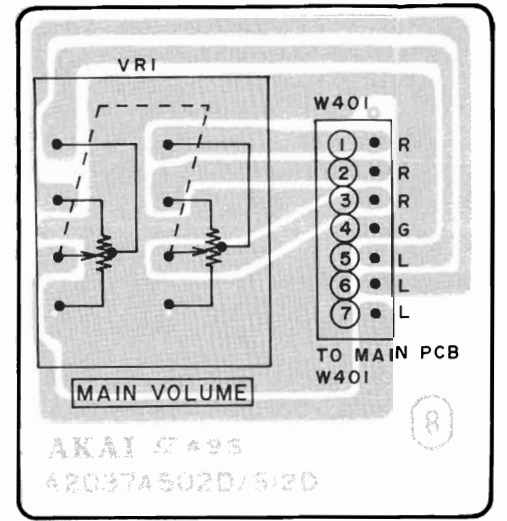

VOLUME PCB  
 A2037A502D U.C.A.E.B.S  
 A2037A521D V

MAIN AMP PCB A2038A501A U  
 502A C.A  
 503A E.B.S  
 504A V

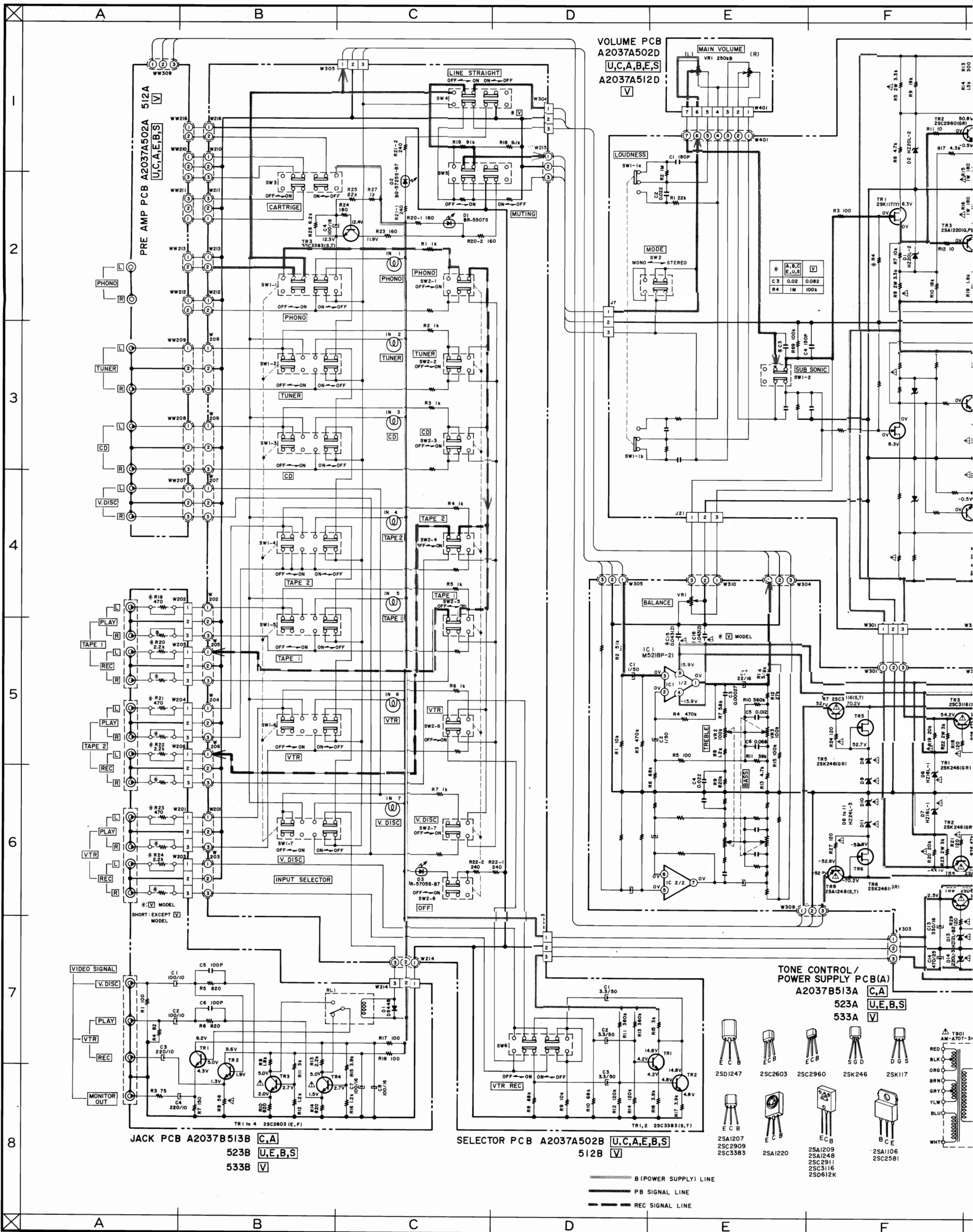

* A,B,C	V
E,U,S	
C 3	0.02 0.082
R 4	1M 100K

2SD1247	2SC2603	2SC2960	2SK246	2SK117
2SA1207	2SC2909	2SC3383	2SA1220	2SA1209
				2SA1248
				2SC2911
				2SC3116
				2SD612K

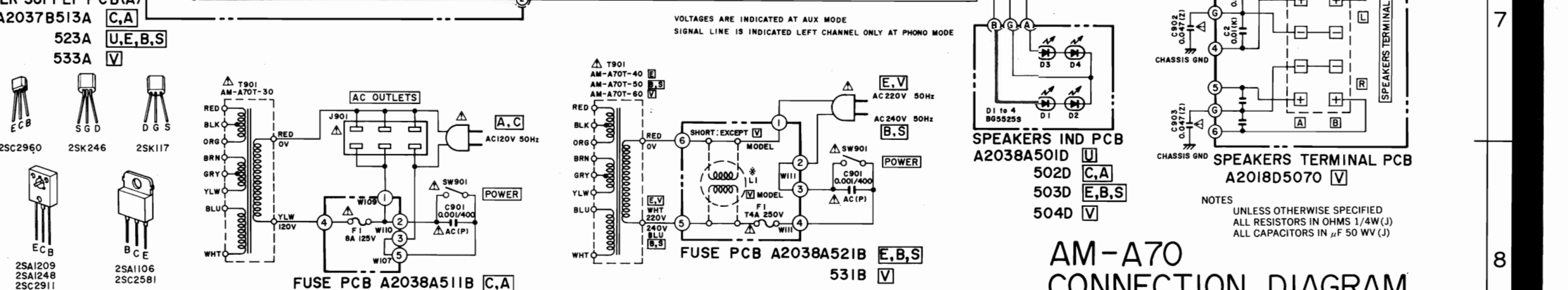
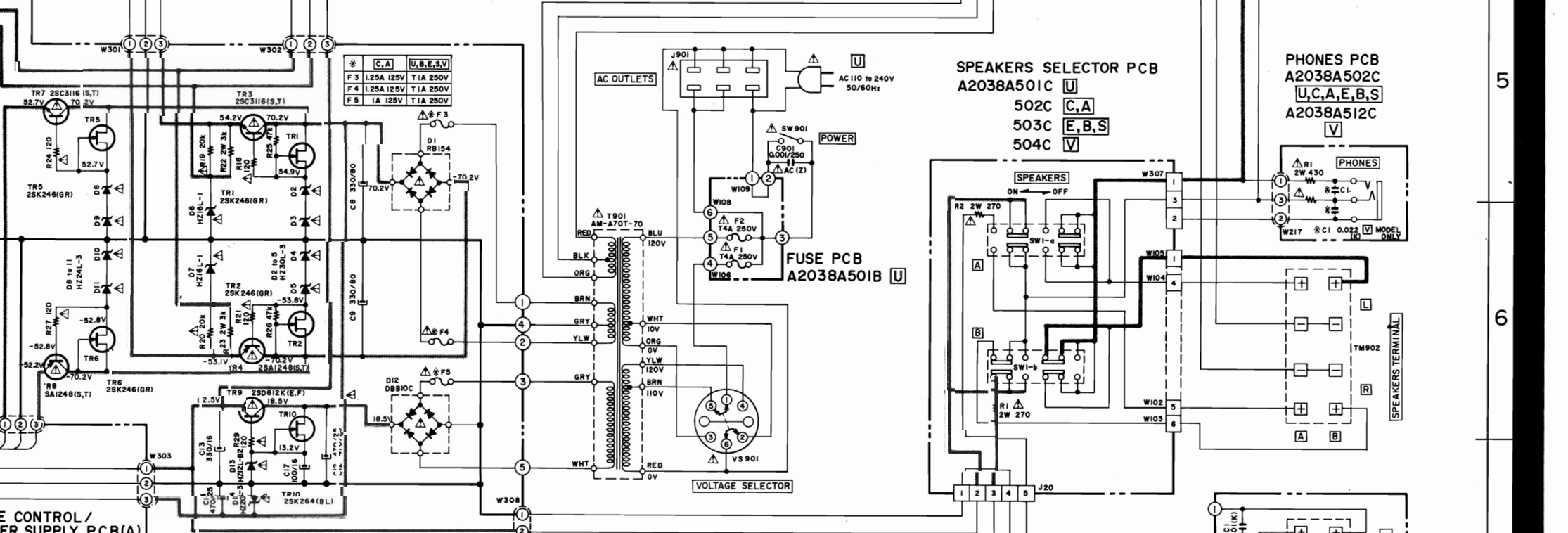
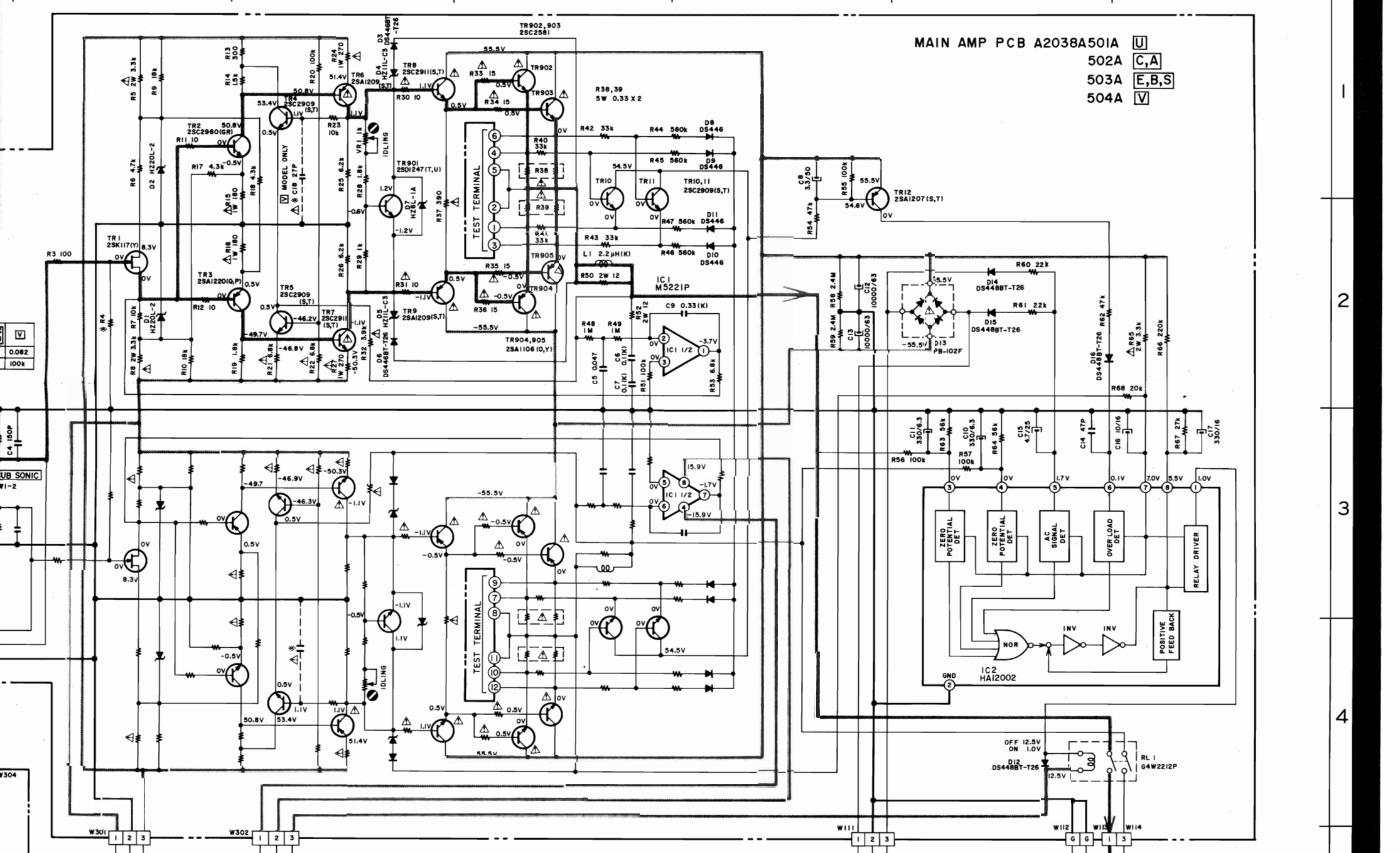

**AM-A70 CONNECTION DIAGRAM No.2-1 851004A**

WARNING: Δ INDICATES SAFETY CRITICAL COMPONENTS. FOR CONTINUED SAFETY, REPLACE SAFETY CRITICAL COMPONENTS ONLY WITH MANUFACTURER'S RECOMMENDED PARTS.  
 AVERTISSEMENT: Δ IL INDIQUE LES COMPOSANTS CRITIQUES DE SÉCURITÉ. POUR MAINTENIR LE DEGRÉ DE SÉCURITÉ DE L'APPAREIL, NE REMPLACER QUE DES PIÈCES RECOMMANDÉES PAR LE FABRICANT.

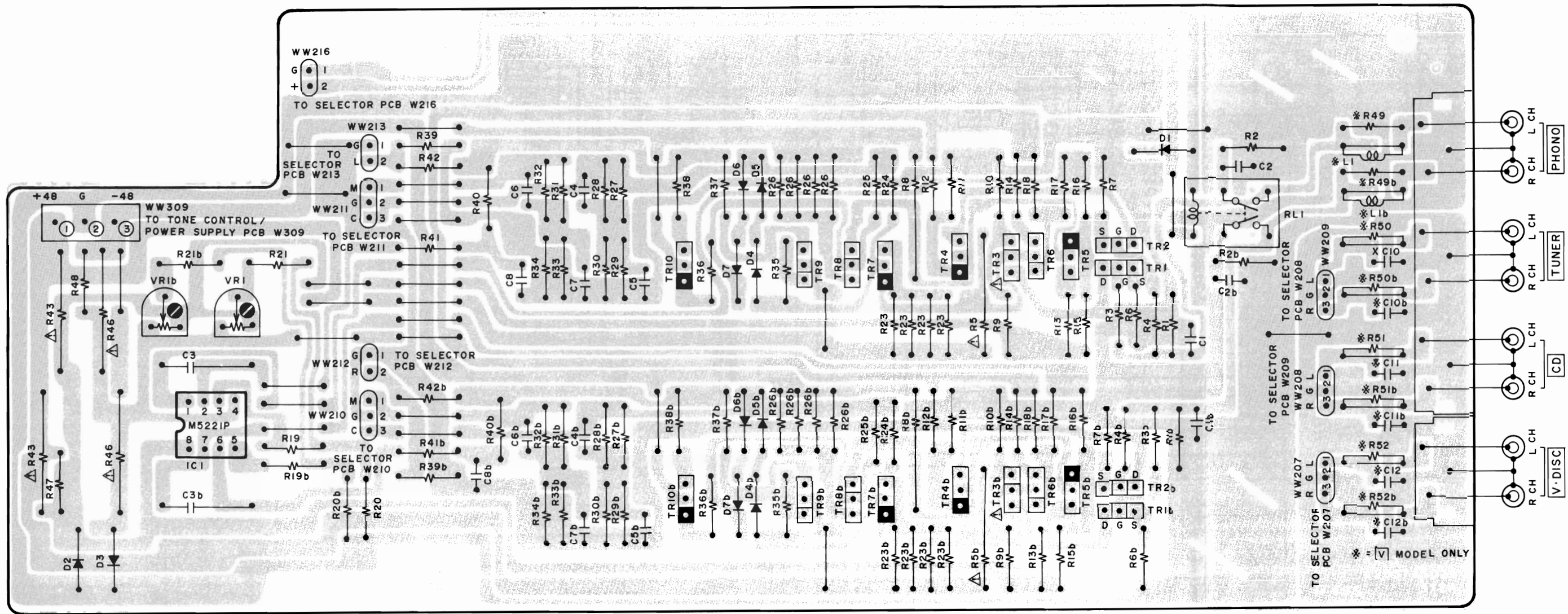

PRE AMP PCB A2037A502A U.C.A.E.B.S  
512A V

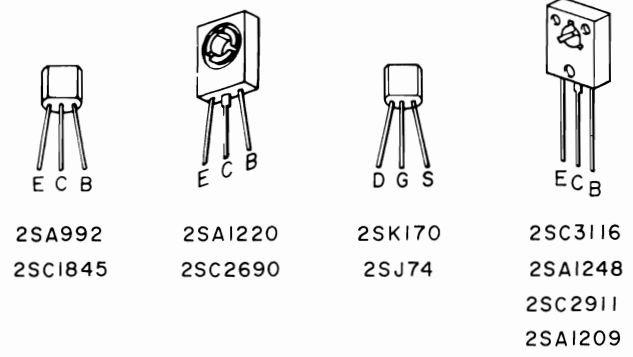

= FILED EFFECT TRANSISTOR  
 = NPN TRANSISTOR  
 = PNP TRANSISTOR

- TR1,1b.....2SK170(BL)
- TR2,2b.....2SJ74(BL)
- TR3,3b.....2SC3116(R,S)
- TR4,4b.....2SA1248(R,S)
- TR5,5b.....2SA992(E,F)
- TR6,6b.....2SC1845(E,F)
- TR7,7b.....2SA1220(Q,P)
- TR8,8b.....2SC2690(Q,P)
- TR9,9b.....2SC2911(S,T)
- TR10,10b.....2SA1209(S,T)

WARNING: INDICATES SAFETY CRITICAL COMPONENTS. FOR CONTINUED SAFETY, REPLACE SAFETY CRITICAL COMPONENTS ONLY WITH MANUFACTURER'S RECOMMENDED PARTS.  
 AVERTISSEMENT: IL INDIQUE LES COMPOSANTS CRITIQUES DE SECURITE. POUR MAINTENIR LE DEGRE DE SECURITE DE L'APPAREIL, NE REMPLACEZ QUE DES PIECES RECOMMANDEES PAR LE FABRICANT.

AM-A70

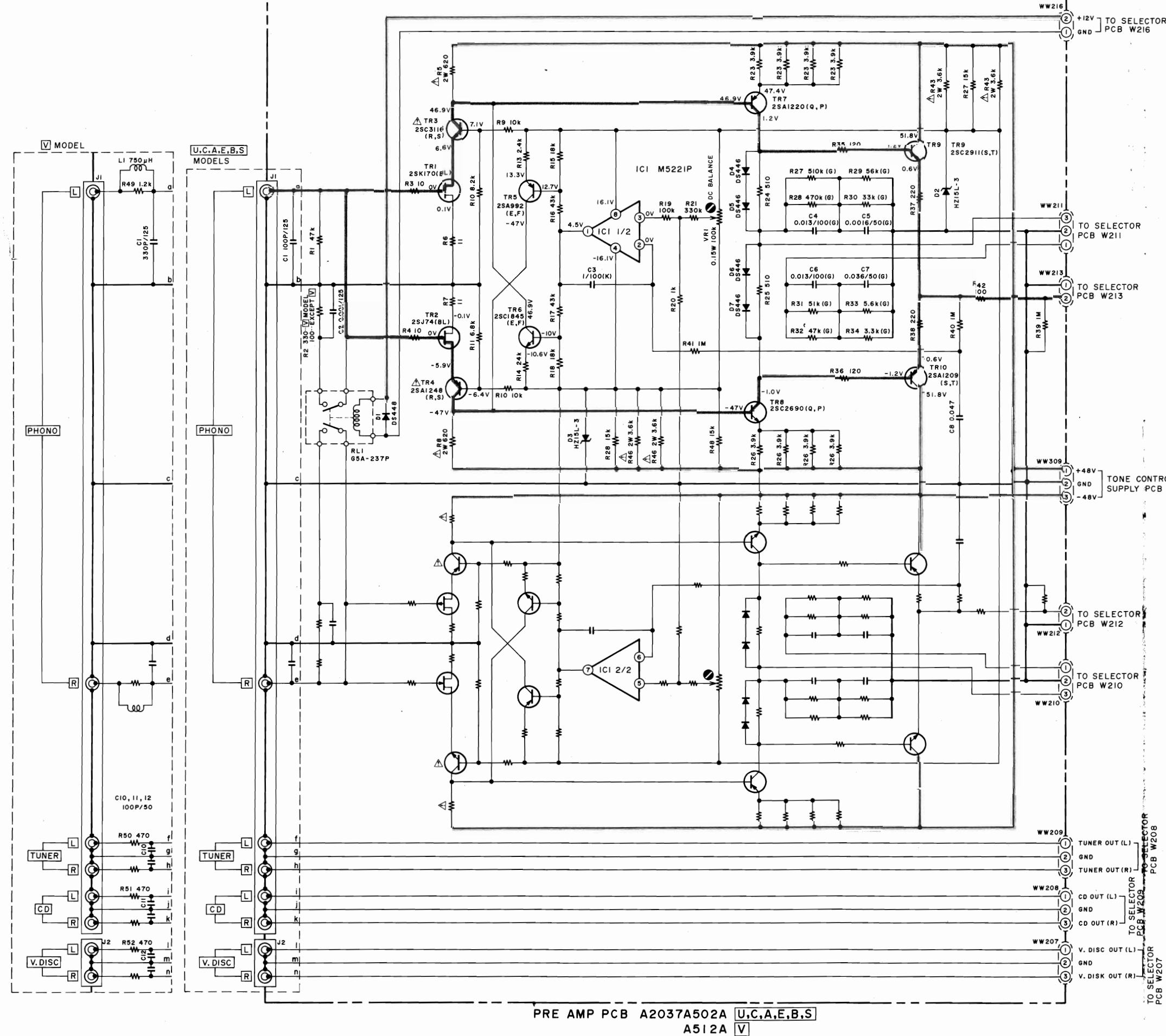

DGS	ECB
2SJ74	2SA992
2SK170	2SC1845
ECB	ECB
2SA1220	2SA1209
2SC2690	2SA1248
	2SC2911
	2SC3116

— = B (POWER SUPPLY) LINE  
 - - - = SIGNAL LINE

INDICATED VOLTAGES ARE MEASURED AT PHONO (M, M) MODE.

WARNING:  $\Delta$  INDICATES SAFETY CRITICAL COMPONENTS FOR CONTINUED SAFETY. REPLACE SAFETY CRITICAL COMPONENTS ONLY WITH MANUFACTURER'S RECOMMENDED PARTS.

AVERTISSEMENT:  $\Delta$  IL INDIQUE LES COMPOSANTS CRITIQUES DE SÉCURITÉ. POUR MAINTENIR LE DEGRÉ DE SÉCURITÉ DE L'APPAREIL, NE REMPLACER QUE DES PIÈCES RECOMMANDÉES PAR LE FABRICANT.

NOTE  
 UNLESS OTHERWISE SPECIFIED  
 ALL RESISTORS IN OHMS 1/4W(J)  
 ALL CAPACITORS IN  $\mu$ F 50WV(J)

AM-A70 PRE AMP  
 SCHEMATIC DIAGRAM  
 No. 2-2 851005A (A2)

PRE AMP PCB A2037A502A U,C,A,E,B,S  
 A512A V