

AT-2200/L

SERVICE MANUAL

PARTS LIST

MODEL AT-2200/L

AKAI

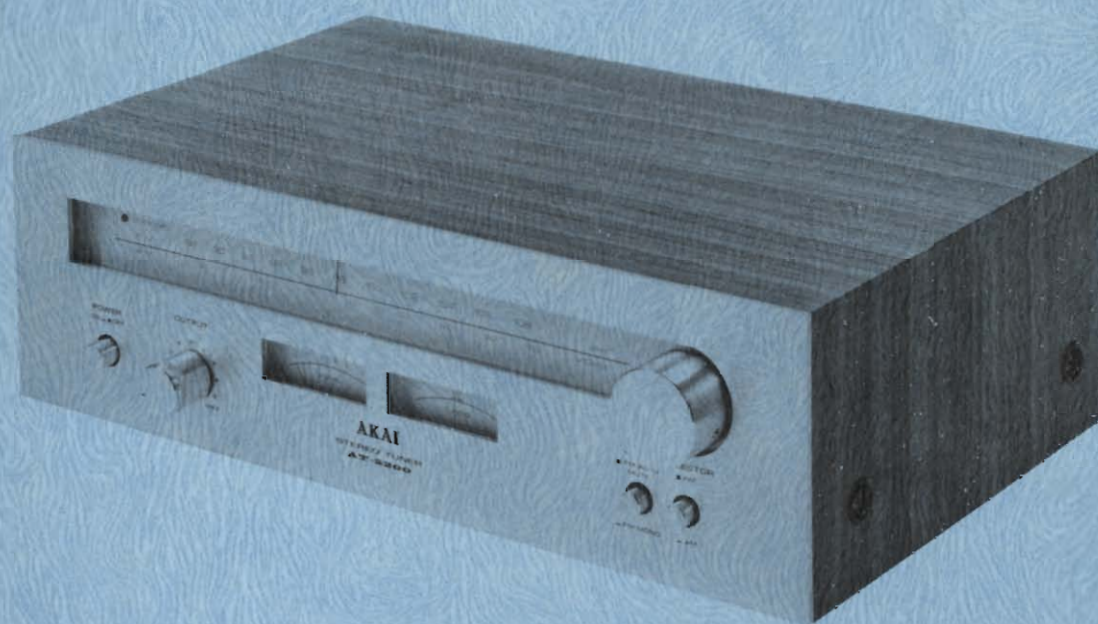

AKAI STEREO TUNER

MODEL AT-2200/L

SECTION 1	SERVICE MANUAL	1
SECTION 2	PARTS LIST	23

SECTION 1

SERVICE MANUAL

TABLE OF CONTENTS

I.	TECHNICAL DATA	2
	1. MODEL AT-2200	2
	2. MODEL AT-2200L	3
II.	DISMANTLING OF UNIT	4
III.	CONTROLS	5
	1. MODEL AT-2200	5
	2. MODEL AT-2200L	5
IV.	PRINCIPAL PARTS LOCATION	6
V.	OPERATING PRINCIPLES OF QUADRATURE DETECTION SYSTEM	6
VI.	OPERATING PRINCIPLES OF PLL CIRCUIT EMPLOYED IN FM STEREO DEMODULATION CIRCUIT	8
	1. PLL CIRCUIT OPERATION	8
	2. STEREO DEMODULATION CIRCUIT	8
VII.	TUNER SECTION ADJUSTMENT	10
	1. MODEL AT-2200	10
	2. MODEL AT-2200L	13
VIII.	TUNING CORD THREADING	15
IX.	COMPOSITION OF P.C BOARD	16
	1. MODEL AT-2200	16
	2. MODEL AT-2200L	17

For basic adjustments measuring methods, and operating principles, refer to GENERAL OPERATING PRINCIPLES AND ADJUSTMENTS.

I. TECHNICAL DATA

1. MODEL AT-2200

FM TUNER SECTION

FREQUENCY RANGE	88 MHz to 108 MHz
SENSITIVITY (IHF)	1.9 μ V
CAPTURE RATIO	1.3 dB
SELECTIVITY (IHF)	More than 60 dB
IMAGE REJECTION	More than 55 dB (98 MHz)
IF REJECTION	More than 85 dB (98 MHz)
SPURIOUS REJECTION	More than 85 dB (98 MHz)
AM SUPPRESSION	50 dB
SIGNAL TO NOISE RATIO	70 dB
HARMONIC DISTORTION MONO	Less than 0.3% (100% modulation)
STEREO	Less than 0.5% (100% modulation)
TUNING INDICATOR	Signal Strength Meter and Center Tuning Meter
MUTING	ON-OFF
STEREO SEPARATION	More than 40 dB (1 kHz)
SUB CARRIER SUPPRESSION	More than 50 dB
OUTPUT VOLTAGE	Variable from 0 to 1,000 mV (100% modulation)
ANTENNA INPUT IMPEDANCE	300 ohms balanced, 75 ohms unbalanced

AM TUNER SECTION

FREQUENCY RANGE	520 kHz to 1,605 kHz
SENSITIVITY (IHF)	180 μ V/m (bar antenna), 17 μ V (external antenna)
SELECTIVITY (IHF)	More than 30 dB
IMAGE REJECTION	More than 55 dB (1,000 kHz)
IF REJECTION	More than 45 dB
SIGNAL TO NOISE RATIO	More than 45 dB
OUTPUT VOLTAGE	Variable from 0 to 350 mV (30% modulation)
ANTENNA	Built-in ferrite bar antenna

MISCELLANEOUS

SEMI-CONDUCTORS	Transistors: 5, Diodes: 7, FETs: 1, ICs: 3
POWER REQUIREMENTS	CSA, UL and LA models: 120V, 60 Hz CEE models: 220V, 60 Hz Other models: 110/220/240V, 50/60 Hz Switchable
DIMENSIONS	380(W) x 125(H) x 263(D)mm (15x4.9x10.3) inches
WEIGHT	4.2 kg (9.2 lbs)

* For improvement purposes, specifications and design are subject to change without notice.

2. MODEL AT-2200L

FM TUNER SECTION

FREQUENCY RANGE	88 MHz to 108 MHz
SENSITIVITY (IHF)	1.9 μ V
CAPTURE RATIO	1.3 dB
SELECTIVITY (IHF)	More than 60 dB
IMAGE REJECTION	More than 55 dB (98 MHz)
IF REJECTION	More than 85 dB (98 MHz)
SPURIOUS REJECTION	More than 85 dB (98 MHz)
AM SUPPRESSION	50 dB
SIGNAL TO NOISE RATIO	70 dB
HARMONIC DISTORTION	MONO STEREO
	Less than 0.3% (100% modulation) Less than 0.5% (100% modulation)
TUNING INDICATOR	Center Tuning Meter and Signal Strength Meter
MUTING	ON-OFF
STEREO SEPARATION	More than 40 dB (1 kHz)
SUBCARRIER SUPPRESSION	More than 50 dB
OUTPUT VOLTAGE	Variable from 0 to 1V (100% modulation)
ANTENNA INPUT IMPEDANCE	300 ohms balanced, 75 ohms unbalanced

AM TUNER SECTION

Medium Wave Band

FREQUENCY RANGE	520 kHz to 1,605 kHz
SENSITIVITY (IHF)	180 μ V/m (bar antenna) 20 μ V (ext. antenna)
SELECTIVITY (IHF)	More than 30 dB
IMAGE REJECTION	More than 45 dB (1 MHz)
IF REJECTION	More than 50 dB
SIGNAL TO NOISE RATIO	More than 50 dB
OUTPUT VOLTAGE	Variable from 0 to 350 mV (30% modulation)

Long Wave Band

FREQUENCY RANGE	150 kHz to 350 kHz
SENSITIVITY (IHF)	300 μ V/m (bar antenna), 30 μ V (ext. antenna)
SELECTIVITY (IHF)	More than 30 dB
IMAGE REJECTION	More than 30 dB (240 kHz)
IF REJECTION	More than 50 dB
SIGNAL TO NOISE RATIO	More than 42 dB
OUTPUT VOLTAGE	Variable from 0 to 350 mV (30% modulation)

MISCELLANEOUS

SEMI-CONDUCTORS	Transistors: 5, Diodes: 7, FET: 1, ICs: 3
POWER REQUIREMENTS	CSA, UL and LA models: 120V, 60 Hz CEE models: 220V, 50 Hz Other models: 110/220/240V, 50/60 Hz switchable
DIMENSIONS (WxHxD)	380 x 125 x 265 mm (15.0 x 4.9 x 10.4")
WEIGHT	4.2 kg (9.3 lbs)

* For improvement purposes, specifications and design are subject to change without notice.

II. DISMANTLING OF UNIT

In case of trouble, etc. necessitating disassembly, please disassemble in the order shown in photographs. Reassemble in reverse order.

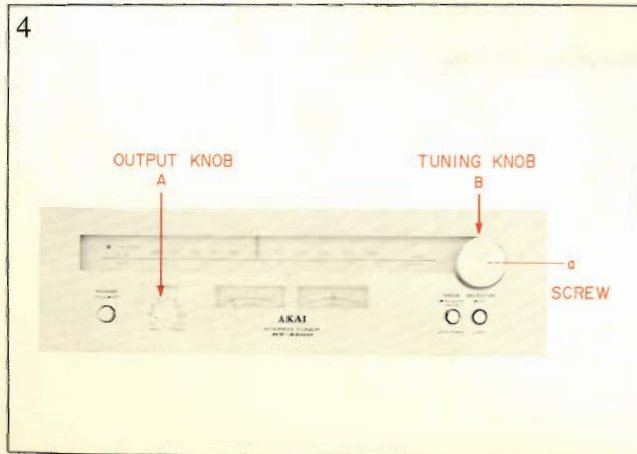
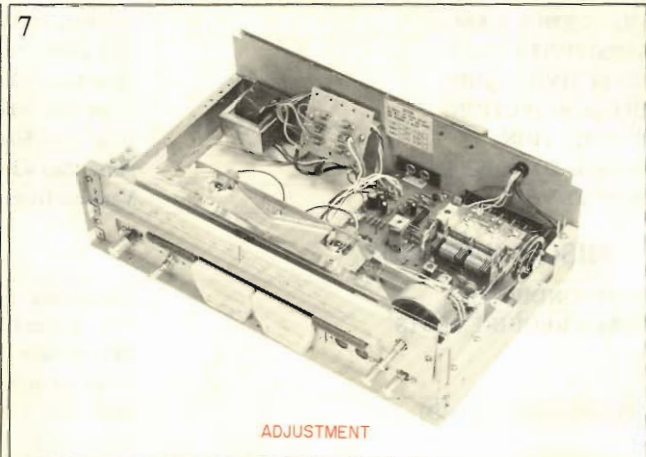
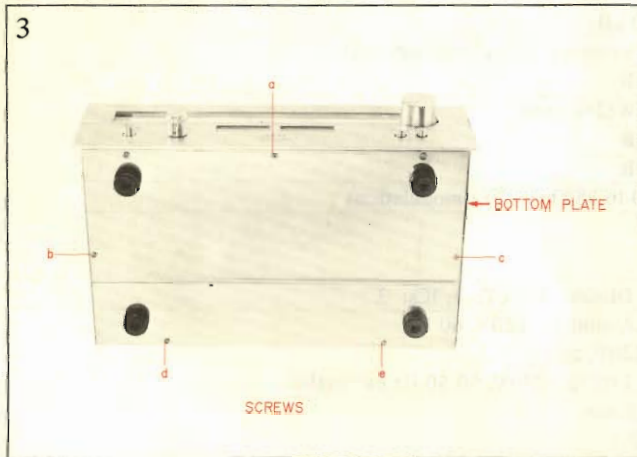
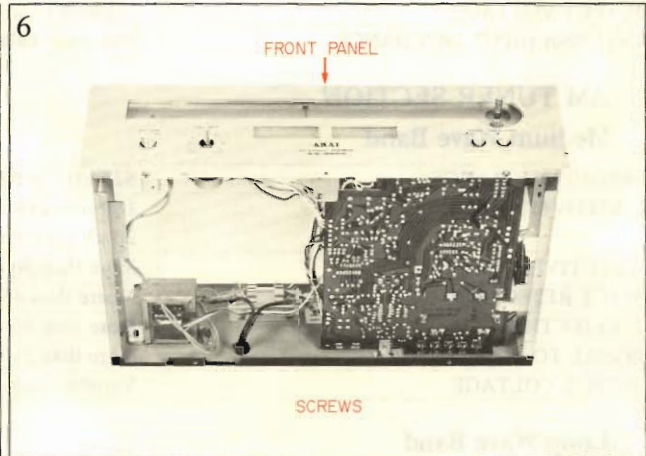
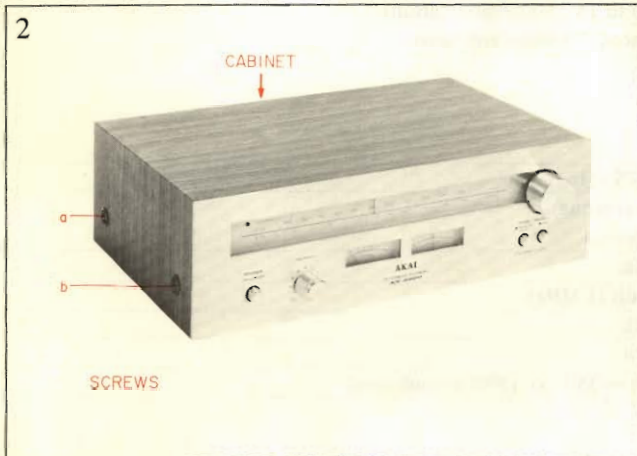
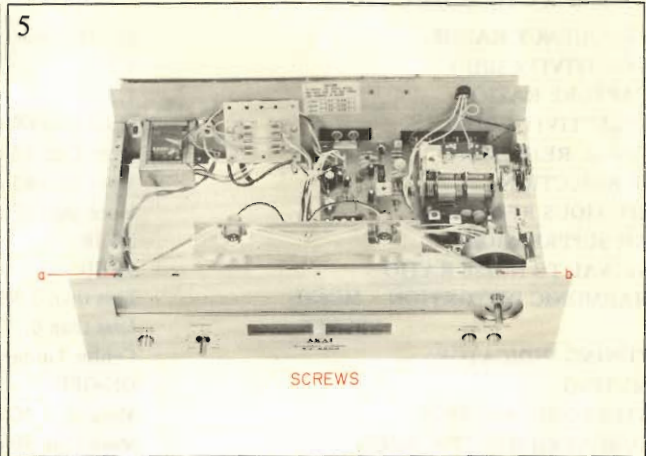

III. CONTROLS

1. MODEL AT-2200

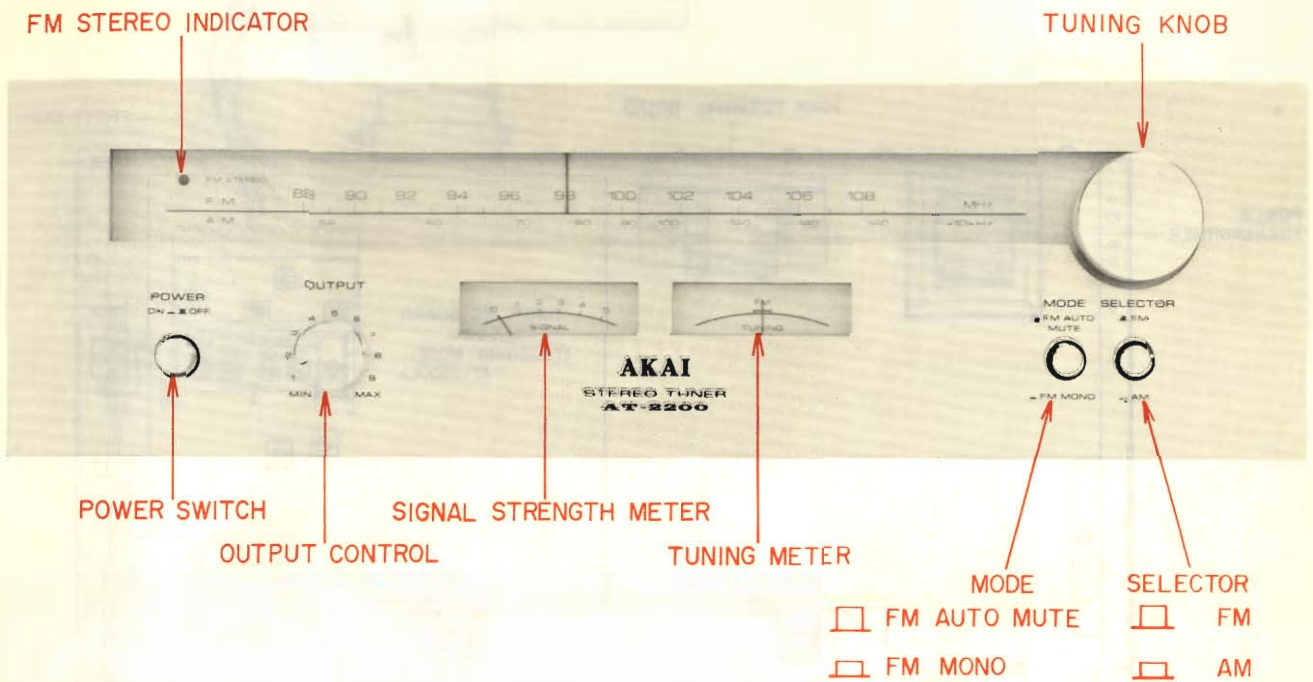

Fig. 1 Controls

2. MODEL AT-2200L

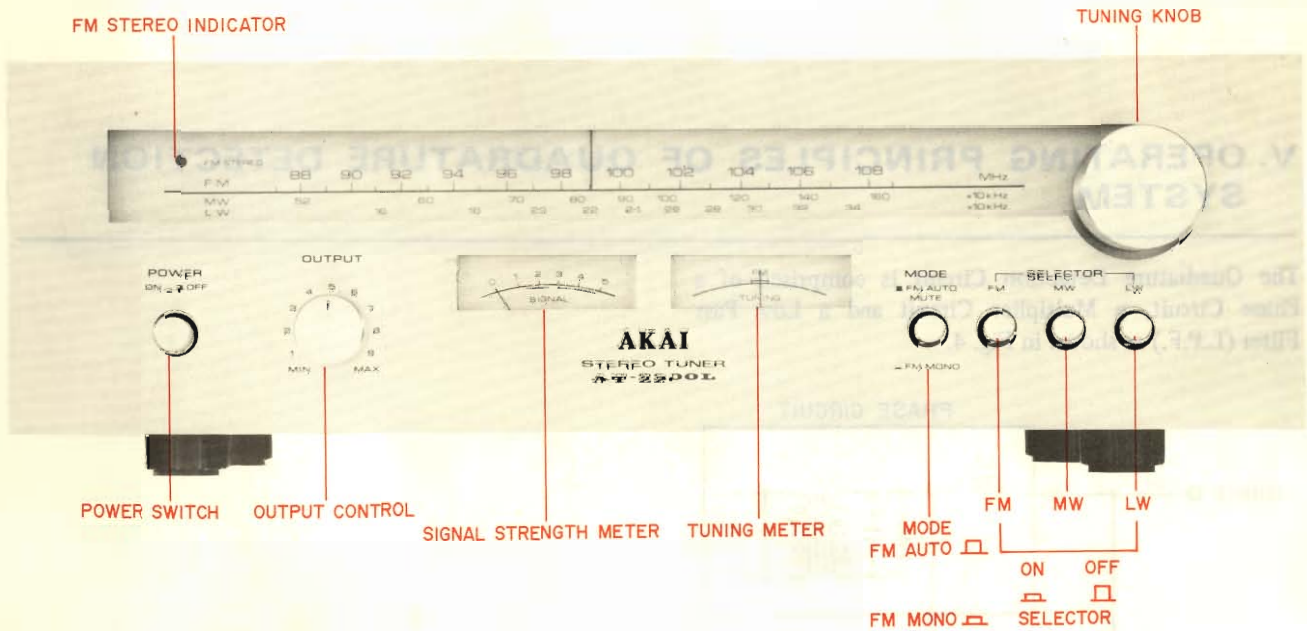

Fig. 2 Controls

IV. PRINCIPAL PARTS LOCATION

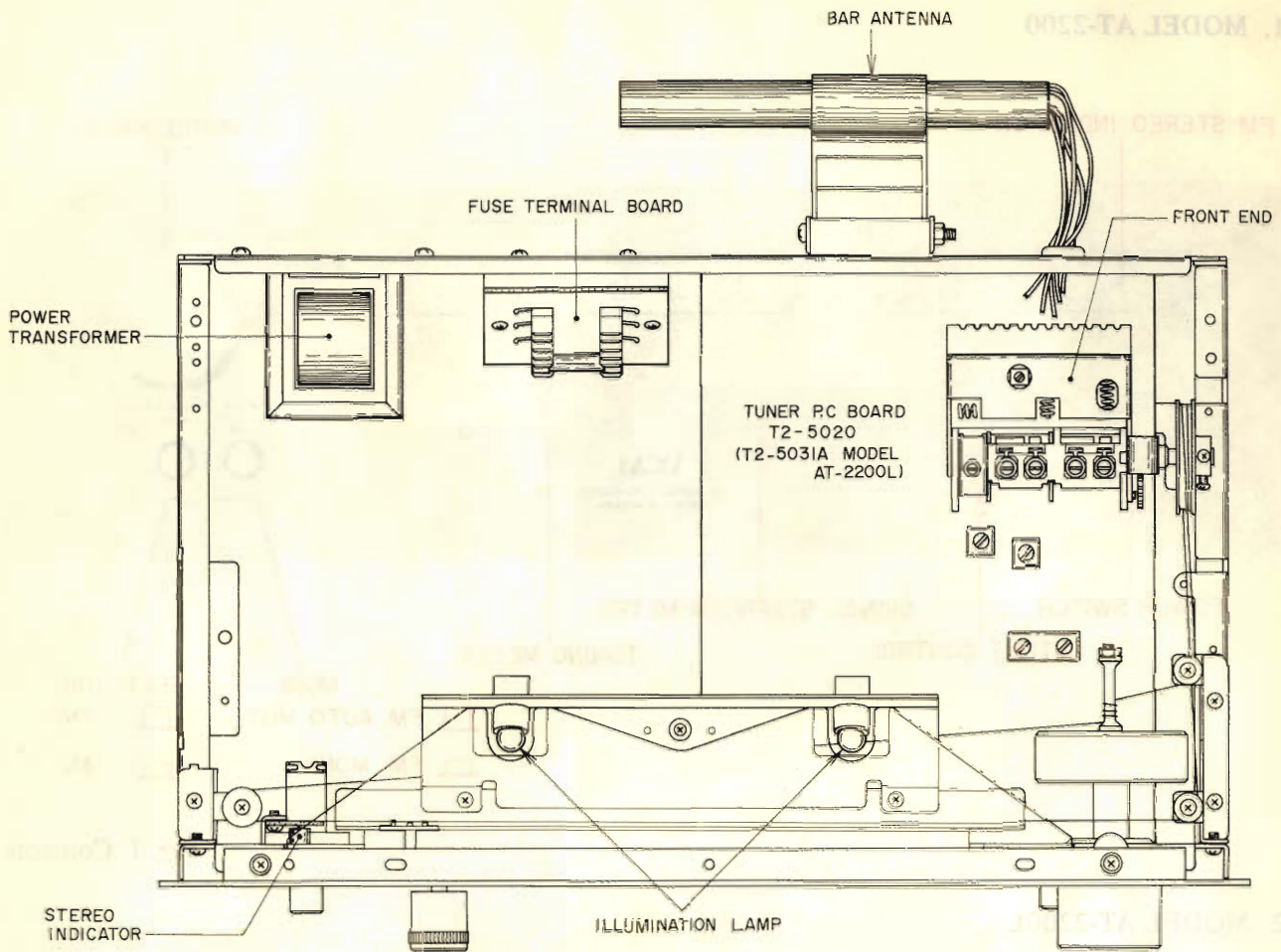

Fig. 3 Principal Parts Location

V. OPERATING PRINCIPLES OF QUADRATURE DETECTION SYSTEM

The Quadrature Detection Circuit is comprised of a Phase Circuit, a Multiplier Circuit and a Low Pass Filter (L.P.F.) as shown in Fig. 4.

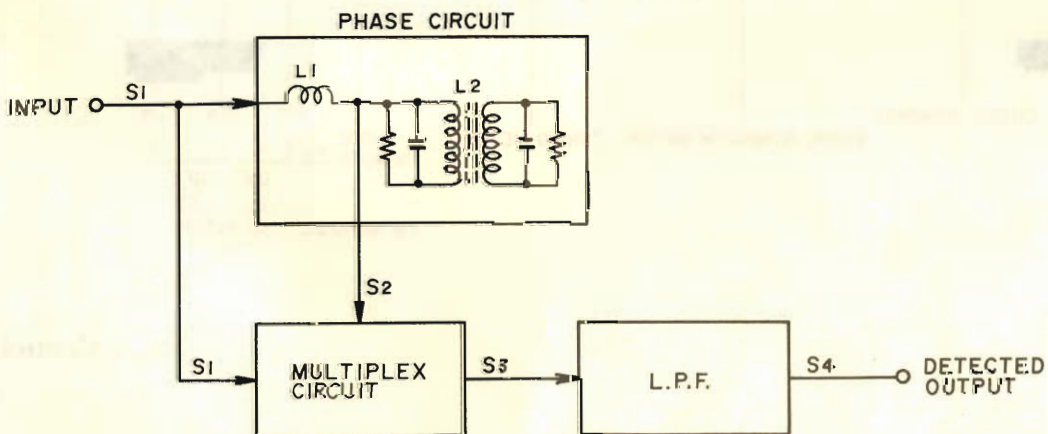

Fig. 4 Quadrature Detection Block Diagram

These are two types of Phase Circuits, the Single tuning type shown in Fig. 5 and the Double tuning type shown in Fig. 6. However, because with the double tuning type there is less frequency deviation in relation to carrier frequency, linearity is improved as shown in Fig. 7, and phase distortion is reduced, this type phase circuit is employed in the AT-2200 and AT-2200L.

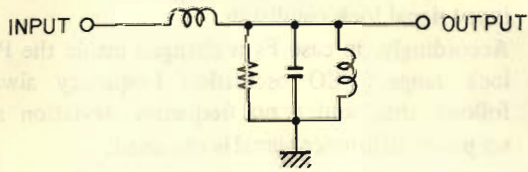

Fig. 5 Single Tuning Type

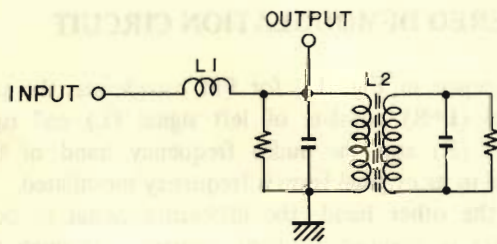

Fig. 6 Double Tuning Type

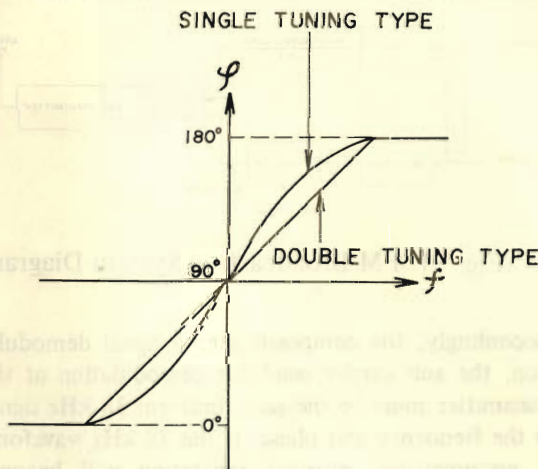

Fig. 7 Tuning Curve

Input signal S1 is divided into the part which enters the direct multiplier circuit and the part which passes the phase circuit and enters the multiplier circuit. The signal supplied to the phase circuit is always 90° phase delayed at L1. Also because at Non-modulation time, L2 is tuned to 10.7 MHz, if modulation is applied and S1 is changed from 10.7 MHz, phase deviation at L2 will take place proportionately in relation to this changed part and this becomes S2 signal which is delayed in relation to S1.

At Non-modulation, because as shown in Fig. 8, input signal S1 and 90° phase delayed (by means of L1) signal S2 are switched by means of the multiplier circuit, the output signal becomes S3.

Because this S3 passes the low pass filter and becomes S4 fixed direct current, the detector output is zero.

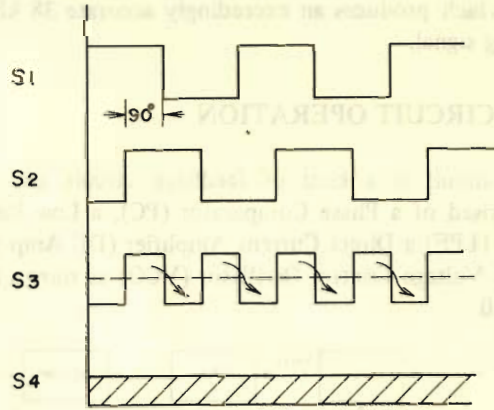

Fig. 8 Output at Non-modulation

Then, when modulation is applied, because the switched output is varied according to the degree of modulation, and the output which passed the low pass filter becomes the pulsating current part as shown in Fig. 9, detector output is obtained.

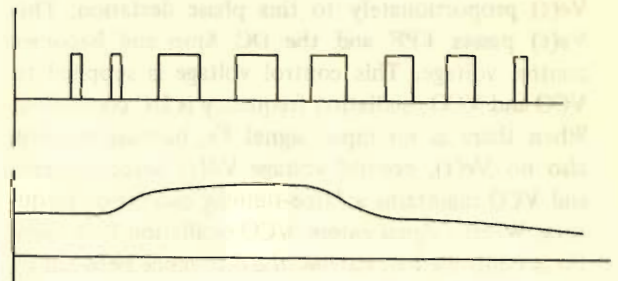

Fig. 9 Output at Modulation Time

VI. OPERATING PRINCIPLES OF PLL CIRCUIT EMPLOYED IN FM STEREO DEMODULATION CIRCUIT

To separate FM stereo broadcast signal received to date into left and right signals, a 19 kHz pilot signal was successively multiplier to form a 38 kHz signal and stereo separation was effected from this. However, with this multiplier system, change in coils due to wear occurred and adjustment points were numerous, etc. Therefore, this model employs a newly developed PLL circuit which produces an exceedingly accurate 38 kHz switching signal.

1. PLL CIRCUIT OPERATION

PLL circuit is a kind of feedback circuit and is comprised of a Phase Comparator (PC), a Low Pass Filter (LPF) a Direct Current Amplifier (DC Amp.), and a Voltage Control Oscillator (VCO) as shown in Fig. 10.

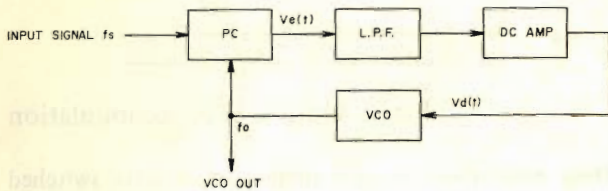

Fig. 10 PLL Circuit

The PC compared input signal F_s and VCO oscillator output and generates the difference in signal voltage $V_e(t)$ proportionately to this phase deviation. This $V_e(t)$ passes LPF and the DC Amp and becomes control voltage. This control voltage is supplied to VCO and VCO oscillation frequency is DC controlled. When there is no input signal F_s , because there is also no $V_e(t)$, control voltage $V_d(t)$ becomes zero, and VCO maintains a *free-running oscillation frequency. When a signal enters, VCO oscillation frequency F_o is controlled to narrow the difference between F_s and F_o by means of feedback as described above, and the PLL circuit assumes a synchronous condition. This is referred to as input signal lock. (In case the difference between F_o and F_s is too large, the differential signal frequency becomes high and is reduced at the LPF. However, because the VCO control voltage does not change, PLL will not stay within the *lock range). Because of the ability of the signal interference removing LPF to accumulate the previous voltage in case the PLL deviates from within the lock range due to certain interference, the original condition is quickly reinstated.

* Free running frequency:

Oscillating frequency when there is no input signal.

* Lock range:

At the condition in which the VCO oscillation frequency is locked to the input signal, the lock range is the oscillating frequency in which when the input signal changes, the PLL maintains it's input signal lock condition.

Accordingly, in case F_s is changed inside the PLL lock range, VCO oscillation frequency always follows this, and a no frequency deviation and no phase difference signal is obtained.

In other words, VCO oscillation frequency can be locked to F_s .

2. STEREO DEMODULATION CIRCUIT

As shown in Fig. 11, for FM broadcasts, the sum signal (L+R) consists of left signal (L) and right signal (R) and the audio frequency band of this signal in its original form is frequency modulated. On the other hand, the difference signal of both (L-R) is changed to high frequency through the use of the sub carrier, and is referred to as the sub channel signal. The carrier is further frequency modulated and sent to the FM stereo transmitter.

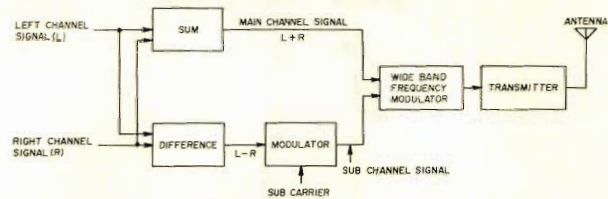

Fig. 11 FM Broadcasting System Diagram

Accordingly, for composite stereo signal demodulation, the sub carrier used for demodulation at the transmitter must be the same uniform 38 kHz signal as the frequency and phase. If the 38 kHz waveform is asymmetrical, channel separation will become poor. At the PLL employed MPX stereo demodulator circuit, as shown in Fig. 10, first a 76 kHz signal is oscillated and when this passes the divider, a symmetrical 38 kHz signal is obtained.

This 38 kHz sub carrier is supplied to the multiplex decoder together with the sub channel of the composite stereo signal. At the multiplex decoder, left and right channel audio signals are separated in order as shown in Fig. 13.

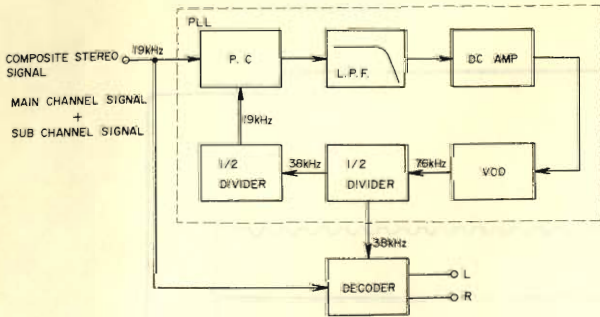

Fig. 12 MPX IC Function

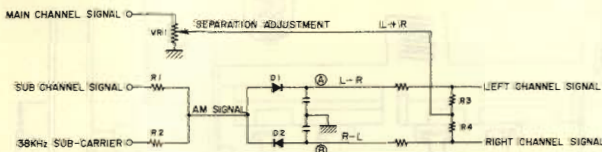

Fig. 13 Multiplex Decoder

The 38 kHz sub carrier composed with the sub channel signal of which the carrier part was removed when sub channel signal and sub carrier passed R1 R2 produces the regular AM wave. Then, because this envelop is detected by mutually reverse polarity connected diodes D1 and D2, L-R signal is emitted at point (A) and R-L signal at point (B).

Also, because main channel signal (L+R) is supplied to R3, R4 center point, (A) (B) point voltage is added and subtracted and becomes

$$(L+R) + (L-R) = 2L \text{ (left channel)}$$

$$(L+R) + (R-L) = 2R \text{ (right channel)}$$

The level of the main channel signal (L+R) can be adjusted by means of variable resistor VR(VR1) for optimum separation.

Thus, the function of actually employed PLL IC LA-3350 is a shown in Fig. 14.

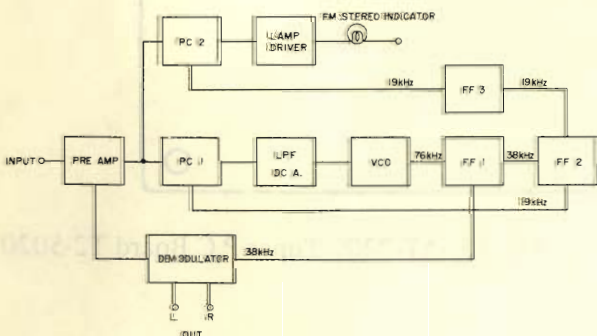

Fig. 14 LA-3350 Function System Diagram

VII. TUNER SECTION ADJUSTMENT

1. MODEL AT-2200

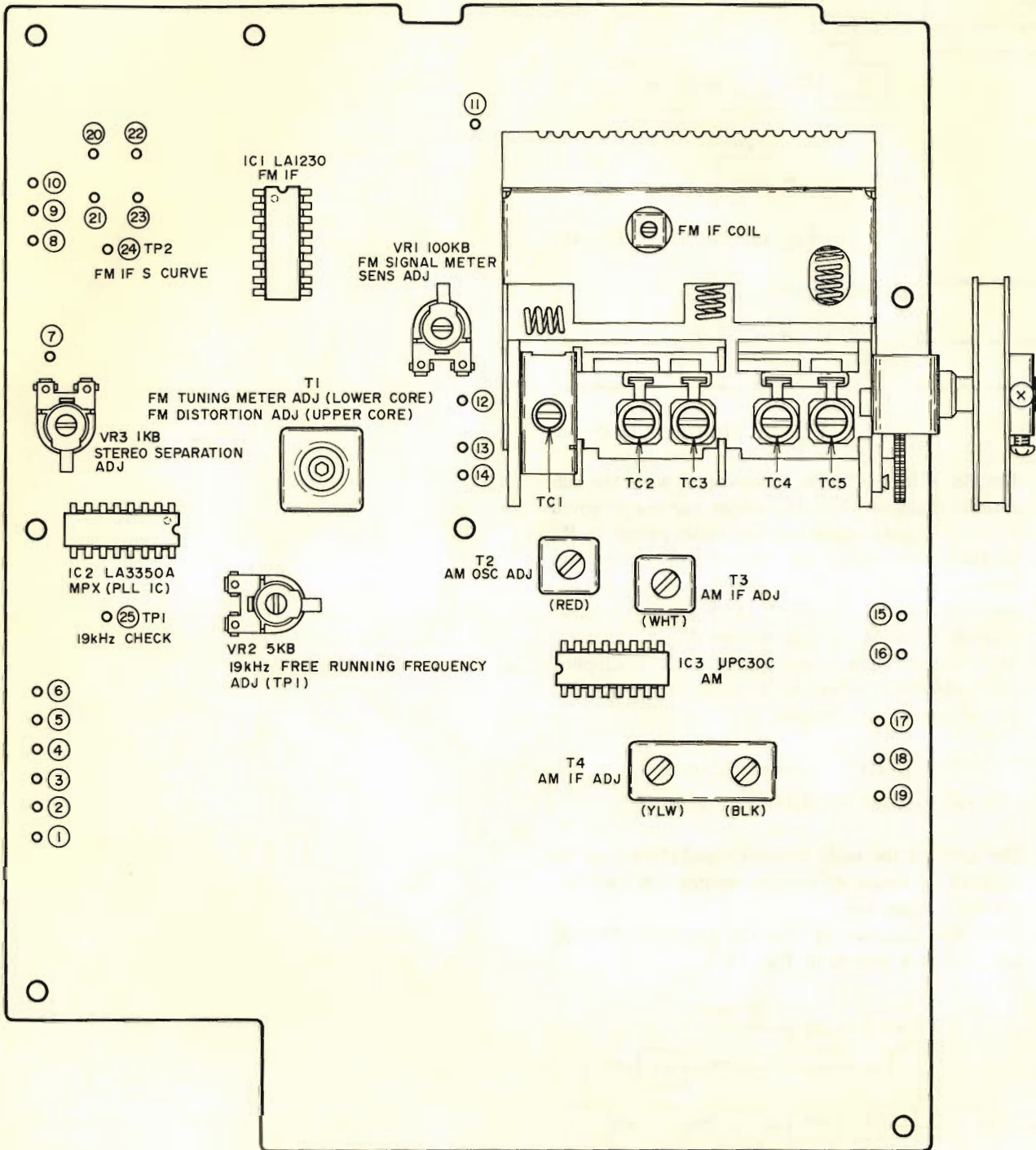

Fig. 15 AT-2200 Tuner P.C Board T2-5020

1) FM Section Adjustment (Refer to Fig. 15)

Step	Adjustment Item	Adjustment Part	Result	Remarks
1	Front End IF Coil	IF Coil (Front End)	Maximum Noise level	Set Selector to FM. Set FM Mute to OFF. Tune only noise without interference of broadcasting
2	Tuning Meter Centering	T1 Lower Side Core (Tuner P.C Board T2-5020)	Center indication of Tuning Meter	(Same as above)
3	Distortion	T1 Upper Side Core (Tuner P.C Board T2-5020)	Less than 0.3% distortion	108 MHz, 60 dB (mono) input. Less than 0.3% distortion both channels.
4	Confirmation of Tuning Meter indication			If Tuning Meter indication is not at center position readjust Steps 2,3 above.
5	Frequency Coverage	TC1 Trimmer Condenser (Front End)		108 MHz, 60 dB (mono) input Error: Within ± 250 kHz
6	Sensitivity	TC3, TC5 Trimmer Condensers (Front End)	Distortion less than 3.0%	108 MHz, Less than 12 dB (mono) input
7	Confirmation of low range sensitivity		Distortion less than 3.0%	88 MHz, Less than 12 dB (mono) input Error: Within ± 250 kHz (See Note 1)
8	Confirmation of midrange sensitivity		Distortion less than 3.0%	98 MHz, Less than 12 dB (mono) input (See Note 1)
9	PLL IC Free Running Frequency	VR2 5 kB (Tuner P.C Board T2-5020)	19.00 kHz	Connect frequency counter to TP-1. Set Mute Switch to ON. (See Note 2)
10	Stereo Indicator Lamp Confirmation			98 MHz, 60 dB (stereo) input. If stereo indicator lamp fails to light, this means that stereo broadcasts are not being received (stereo separation not attained).
11	Left Stereo Separation	VR3 1 kB (Tuner P.C Board T2-5020)	More than 40 dB	98 MHz, 60 dB (stereo) L-CH input. Distortion less than 0.5%
12	Right Stereo Separation Confirmation		More than 40 dB	98 MHz, 60 dB (stereo) R-CH input. Distortion less than 0.5% (See Note 3)
13	Signal Meter Sensitivity	VR1 100 kB (Tuner P.C Board T2-5020)	Indicator at "5"	98 MHz, 100 dB (mono) input.

Chart-1

- Note 1. In the event that distortion factors in Steps 7 and 8 are not less than 3%, readjust Front End Trimmer Condensers TC3 and TC5 to obtain a minimum average distortion factor at 88, 98, and 108 MHz (same distortion factor at all three points).
- Note 2. PLL IC free running frequency must be an exact 19.00 kHz.
- Note 3. In the event that distortion factors in Steps 11 and 12 are not less than 0.5%, adjust by turning IF Coil in Step 1 within 1/2 turn.

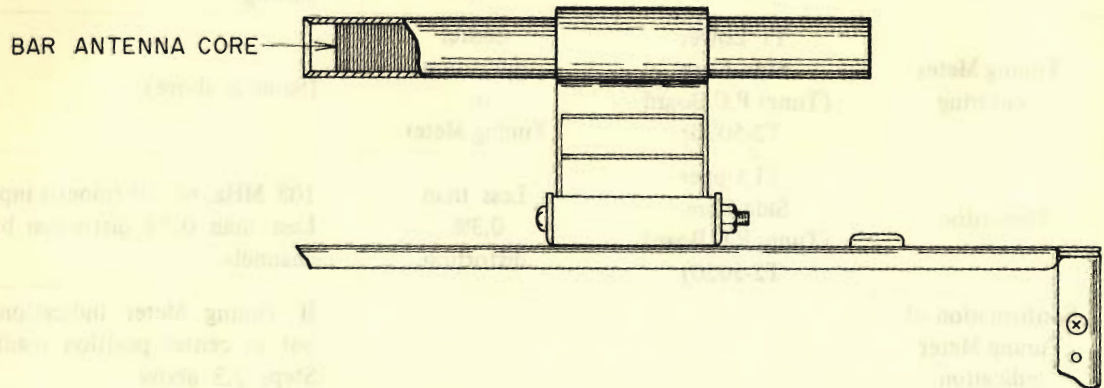

Fig. 16 Bar Antenna

2) AM Section Adjustment (Refer to Fig. 15 and Fig. 16)

Step	Adjustment Item	Adjustment Part	Result	Remarks
1	Low range frequency Coverage	T2 (RED)(Tuner P.C Board T2-5020)	Error: Within 2%	Set Selector to AM. 520 kHz optional input.
2	Low range sensitivity	Bar Antenna core, T4 (YLW,BLK) T3 (WHT)(Tuner P.C Board T2-5020)	Maximum Sensitivity	520 kHz optional input.
3	High range frequency Coverage	TC2 Trimmer Condenser (Front End)	Error: Within 2%	1,400 kHz optional input.
4	Hgh range sensitivity	TC4 Trimmer Condenser (Front End)	Maximum Sensitivity	1,400 kHz optional input.
5	Scale and sensitivity Confirmation			Repeat Steps 1 through 4 two or three times.

2. MODEL AT-2200L

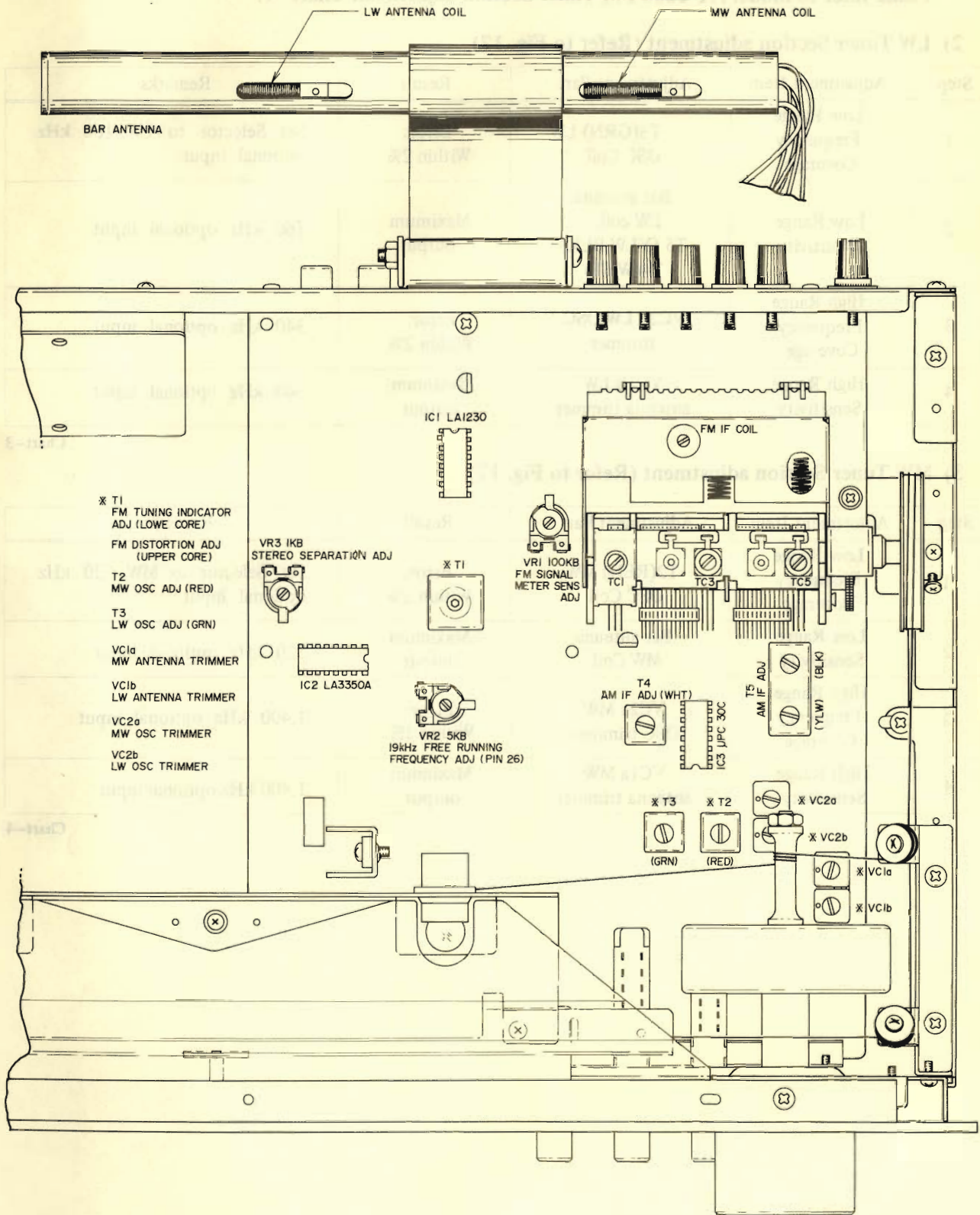

Fig. 17 AT-2200L Tuner P.C Board T2-5031A

1) FM Tuner Section adjustment (Refer to Fig. 17)

Please refer to model AT-2200 FM Tuner Section adjustment Chart-1.

2) LW Tuner Section adjustment (Refer to Fig. 17)

Step	Adjustment Item	Adjustment Part	Result	Remarks
1	Low Range Frequency Coverage	T3(GRN) LW OSC Coil	Error: Within 2%	Set Selector to LW 160 kHz optional input
2	Low Range Sensitivity	Bar antenna LW coil. T5 (YLW,BLK) T4(WHT)	Maximum output	160 kHz optional input
3	High Range Frequency Coverage	VC2b LW OSC trimmer	Error: Within 2%	340 kHz optional input
4	High Range Sensitivity	VC1b LW antenna trimmer	Maximum output	340 kHz optional input

Chart-3

3) MW Tuner Section adjustment (Refer to Fig. 17)

Step	Adjustment Item	Adjustment Part	Result	Remarks
1	Low Range Frequency Coverage	T2(RED) MW OSC Coil	Error: Within 2%	Set Selector to MW 520 kHz optional input
2	Low Range Sensitivity	Bar antenna MW Coil	Maximum output	520 kHz optional input
3	High Range Frequency Coverage	VC2a MW OSC trimmer	Error: Within 2%	1,400 kHz optional input
4	High Range Sensitivity	VC1a MW antenna trimmer	Maximum output	1,400 kHz optional input

Chart-4

VIII. TUNING CORD THREADING

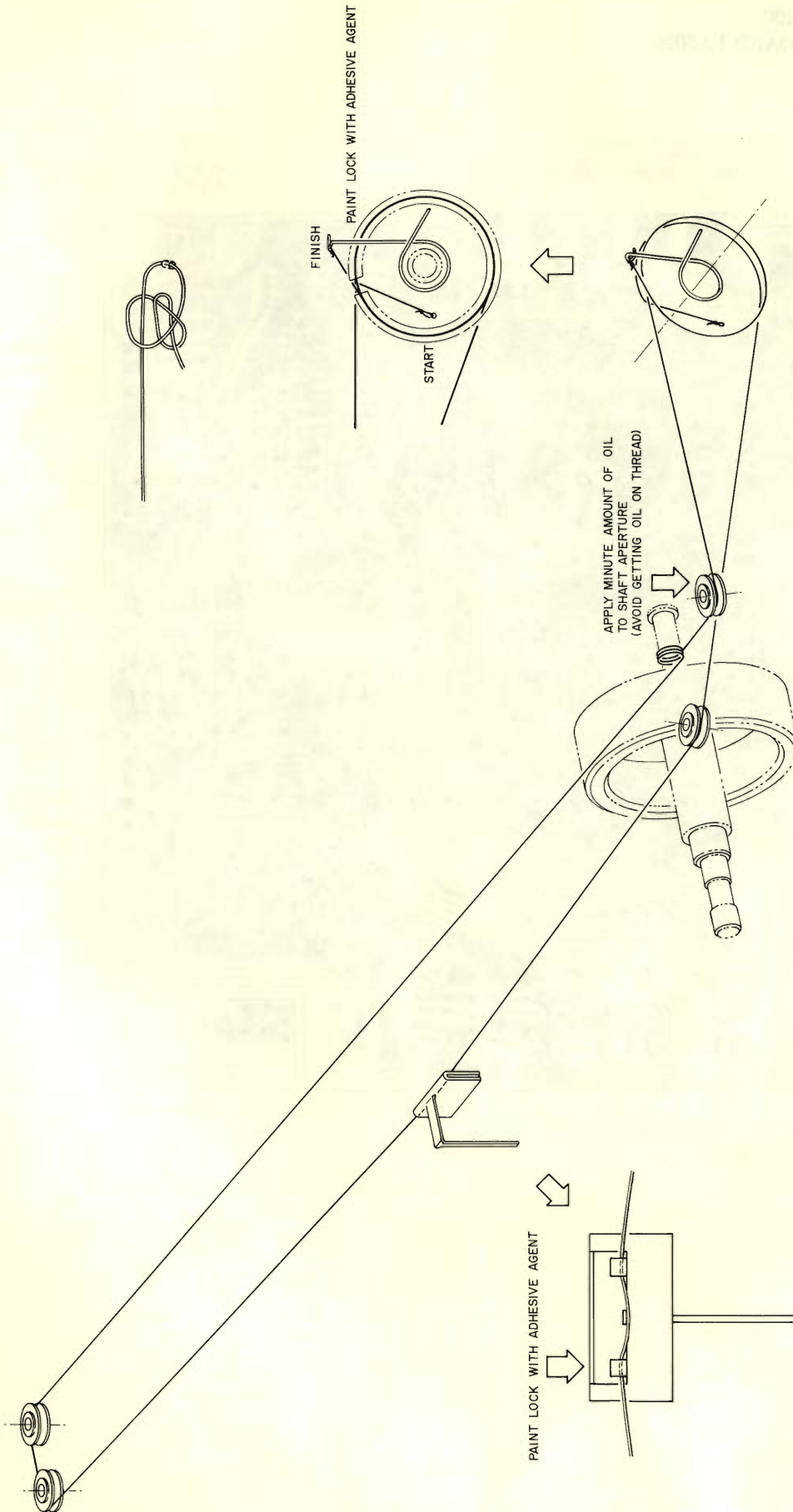
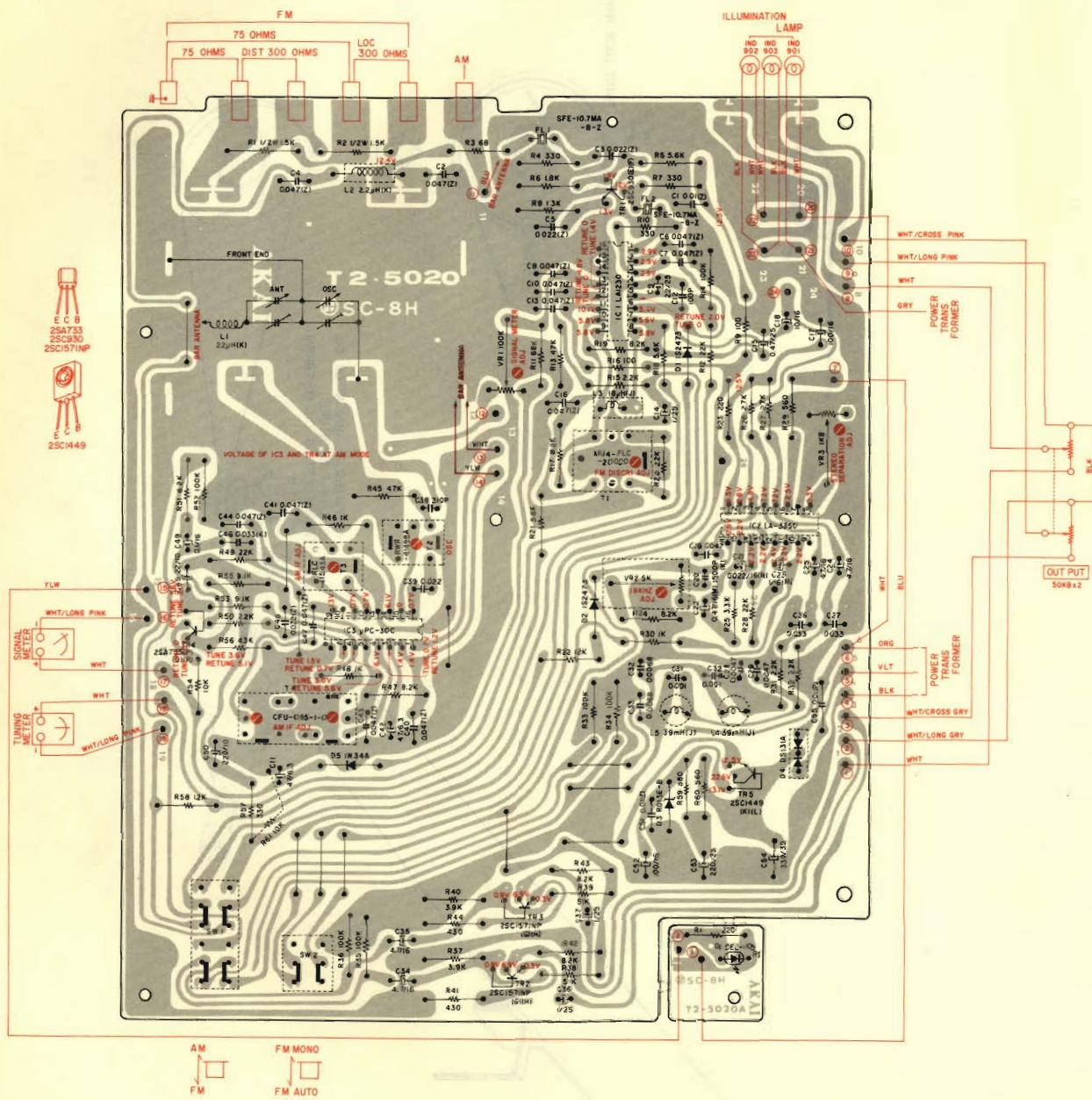

Fig. 18 Tuning Cord Threading

IX. COMPOSITION OF P.C BOARD

1. MODEL AT-2200 TUNER P.C BOARD T2-5020



2. MODEL AT-2200L TUNER P.C BOARD T2-5031A

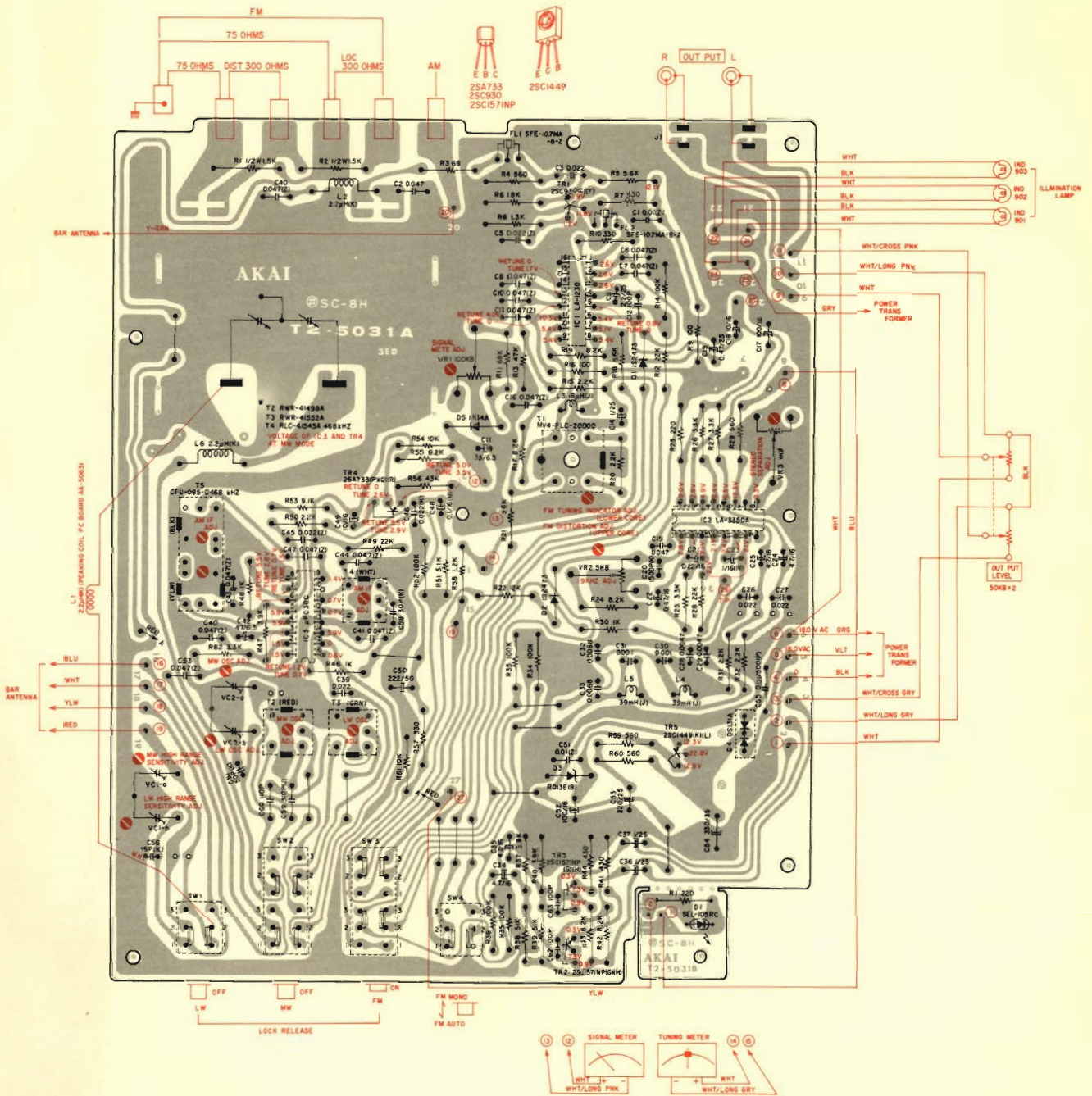

MEMO

MEMORANDUM FOR THE RECORD
DATE: 10/10/50

MEMORANDUM FOR THE RECORD
SUBJECT: [Illegible]

[Illegible text block containing several paragraphs of text, mostly obscured by a large, faint watermark or bleed-through from the reverse side of the page.]

MEMO

M E M O

M E M O

M E M O

SECTION 2

PARTS LIST

TABLE OF CONTENTS

1. RECOMMENDED SPARE PARTS LIST	25
2. TUNER P.C BOARD (T2-5020) (T2-5031A) BLOCK	26
3. ASSEMBLY BLOCK	27
4. FINAL ASSEMBLY BLOCK	29
5. LIST OF INTERCHANGEABLE SEMICONDUCTORS	30
INDEX	31

Resistor and Capacitor which is not listed in this parts list, please refer to
COMMON LIST FOR SERVICE PARTS.

HOW TO USE THIS PARTS LIST

1. This parts list is compiled by various individual blocks based on assembly process.
2. When ordering parts, please describe parts number, serial number, and model number in detail.
3. How to read list.

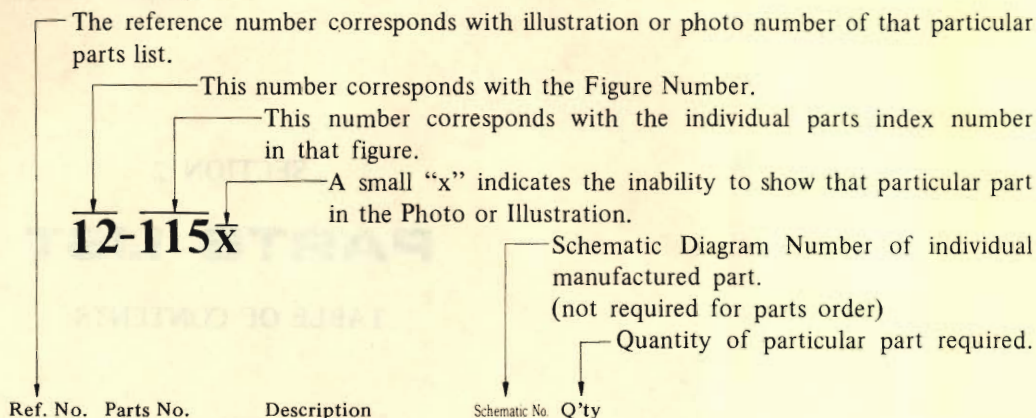

Ref. No.	Parts No.	Description	Schematic No.	Q'ty
FLYWHEEL BLOCK #13				
12-115x	800425	Flywheel Block Assy. Comp.	RDG #13	1
12-116	244506	Flywheel Only	RD-233	1
12-117x	244754	Felt, Flywheel	RD-275	1
12-118	251324	Main Metal Case	RD-236	1
12-119	253080	Main Metal	RD-237	1

4. The symbol numbers shown on the P.C. Board list can be matched with the Composite Views of components of the Schematic Diagram or Service Manual.
5. The indications of Resistors and Capacitors in the photos of P.C. Board are being eliminated.
6. The shape of the parts and parts name, etc. can be confirmed by comparing them with the parts shown on the Electrical Parts Table of P.C. Board.
7. Both the kind of part and installation position can be determined by the Parts Number. To determine where a parts number is listed, utilize Parts Index at end of Parts List.
It is necessary first of all to find the Parts Number. This can be accomplished by using the Reference Number listed at right of parts number in the Parts Index. (meaning of ref. no. outlined in Item 3 above).
8. Utilize separate "Price List for Parts" to determine unit price. The most simple method of finding parts Price is to utilize the reference number.

CAUTION:

1. When placing an order for parts, be sure to list the parts no., model no., and description. There are instances in which if any of this information is omitted, parts cannot be shipped or the wrong parts will be delivered.
2. Please be careful not to make a mistake in the parts no. If the parts no. is in error, a part different from the one ordered may be delivered.

1. RECOMMENDED SPARE PARTS LIST

Parts No.	Parts Nomenclature	Reference No.
BA211184	Tuner P.C Board Comp. T2-5020	
BC224820	Cabinet B M2-5013	
BD211162	Front Panel Comp. AT-2200(U)	
BT223470	Power Transformer AT-2200T-1	T901
BT215021	Power Transformer AT-2200T-2	T901 (CSA)
BT215032	Power Transformer AT-2200T-3	T901 (CEE)
ED694091	Luminous Diode SEL105RC	
ED624903	Silicon Diode 1S2473	
ED223558	Zener Diode RD13E (B)	
ED223547	Silicon Diode DS131A	
ED219464	Germanium Diode 1N34A	
EE223481	Bar Antenna	ANT901
EE240333	Bar Antenna	Interchangeable with ANT901
EE655301	Front End FB512U13	Same as AA-1010
EI650586	IC LA1230	
EI650597	IC LA3350A	
EI650362	IC μ PC30C	
EJ223457	2P Pin Jack JPJ355	J1
EL224010	Lamp (Cord Type) 8V 300 mA	IND901
EL215076	Lamp (Cord Type) 8V 300 mA	IND902,903
EM664402	Tuning Meter 85C243	M901
EM204355	Tuning Meter KL-243X-10	Interchangeable with M901
EM664413	Signal Meter 85C242	M902
EM204344	Signal Meter KL-243X-9	Interchangeable with M902
EO650608	Discri Coil MV4-FLC-20000	T1
EO697948	Discri Coil SNY-1715	Interchangeable with T1
EO650395	Osc Coil RWR-41498A	T2
EO698027	Osc Coil 33Y-775	Interchangeable with T2
EO650373	AM IF Trans RLC-41543A 468 kHz	T3
EO698038	AM IF Trans 33Y-780	Interchangeable with T3
EO650384	AM IF Trans CFU-012-D 468 kHz	T4
EO650610	Inductor 18 μ H(J)	L3
EO650428	Inductor 39 MH(J)	L4,5
ER650430	Ceramic Filter SFE-10.7MA-8-Z	
ES223468	Push Switch 2F-0027FF2020	SW1
ES224436	Power Switch	SW901
ES257174	Power Switch	SW901 (CSA)
ES242346	Power Switch	SW901 (CEE)
ET618873	Transistor 2SC930 (E) (F)	
ET223446	Transistor 2SC1571 NP (G) (H)	
ET539122	Transistor 2SA733 (P) (Q) (R)	
ET649034	Transistor 2SC1449 (K) (L)	
EV550023	Semi-fixed Volume V10K8-4-2 100 kB	VR1
EV550023	Semi-fixed Volume V10K8-4-2 5 kB	VR2
EV484863	Semi-fixed Volume V10K8-4-2 1 kB (Metalized Film)	VR3
EV223986	Single axial 2 through Volume	VR901
EZ655187	5P Antenna Terminal Plate	
SK224886	Power Knob M2-5021	
SK634410	Push Button Knob J 91-5051	
SK646817	Single Knob AA-5250	
SK223705	Tuning Knob T2-5019	
SP223626	Rear Panel A T2-5006	
SZ645243	Circular Foot A CA-6014	
*BA270898	Tuner P.C Board Comp. T2-5031A	
*BD270887	Front Panel Block Comp. AT-2200L(U)	
*EC616342	Trimmer Condenser CTY-15D33 12PF	VC1,2
*EE239321	Bar Antenna (MW, LW)	ANT901
*EO239308	Osc Coil RWR-41552A	T3
*ES239297	Push Switch SUE44	SW1

NOTE: An asterisk mark indicates parts are only employed for model AT-2200L.

2. TUNER P.C BOARD (T2-5020) (T2-5031A) BLOCK

Symbol No.	Parts No.	Description	Q'ty
2-1	BA211184	Tuner P.C Board Comp. (T2-5020)	1
2-2	BA270898	Tuner P.C Board Comp. (T2-5031A)(2200L)	1
2-IC1	EI650586	IC LA1230	1
2-IC2	EI650597	IC LA3350A	1
2-IC3	EI650362	IC μ PC30C	1
2-TR1	ET618873	Transistor 2SC930 (E)(F)	1
2-TR2,3	ET223446	Transistor 2SC1571NP(G)(H)	2
2-TR4	ET539122	Transistor 2SA733(P)(Q)(R)	1
2-TR5	ET649034	Transistor 2SC1449 (K)(L)	1
2-D1,2	ED624903	Silicon Diode 1S2473	2
2-D3	ED223558	Zener Diode RD13E(B)	1
2-D4	ED223547	Silicon Diode DS131A	1
2-D5	ED219464	Germanium Diode 1N34A	1
2-VC1,2	EC675742	Trimmer/C. CTY-21D 15PF	2
2-SW1	ES223468	Push SW. 2F-0027FF2020	1
2-SW1	ES239297	Push SW. 4F-0063FF2020 (2200L)	1
2-J1	EJ223457	2P Pin Jack JPI355	1
2-FL1,2	ER650430	Ceramic Filter SFE-10.7 MA-8-Z	2
2-T1	EO650608	Discri Coil MV-FLC-20000	1
2-T2	EO650395	OSC Coil RWR-41498A	1
2-T3	EO650373	AM-IF Trans. RLC-41543A 468 kHz	1
2-T3	EO239308	OSC Coil RWR-41552A (2200L)	1
2-T4	EO650384	AM-IF Trans. CFU-085-D 468 kHz	1
2-T4	EO650373	AM-IF Trans. RLC-41543A 468 kHz (2200L)	1
2-T5	EO650384	AM-IF Trans. CFU-085-D 468 kHz (2200L)	1
2-L1,2	EO539820	Peaking Coil 2.2 μ H(K)	2
2-L3	EO650610	Inductor 144LZ 18 μ H(J)	1
2-L4,5	EO650428	Inductor 146LY 39 mH(J)	2
2-VR1	EV550023	Semi-fixed/Vol. V10K8-4-2 100 kB	1
2-VR2	EV499364	Semi-fixed/Vol. V10K8-4-2 5 kB	1
2-VR3	EV484863	Semi-fixed/Vol. V10K8-4-2 1 kB	1
2-3	ZS325495	Tapping Screw #2 3x6 (BR)	1
		Capacitor, Vertical Type	
2-C20	EC666483	Styrol 1500PF(K) 50WV	1
2-C21	EC223582	Solid Aluminum 0.22 μ F(M) 16WV	1
2-C22	EC215065	Solid Aluminum 0.47 μ F(M) 16WV	1
2-C23	EC223413	Solid Aluminum 1 μ F(M) 16WV	1
2-C38	EC650406	Styrol 310PF(J) 50WV (2200)	1
2-C48	EC223560	Solid Aluminum 0.1 μ F(M) 16WV	1
2-C59	EC650406	Styrol 310PF(J) 50WV (2200L)	1

3. ILLUSTRATION OF ASSEMBLY BLOCK

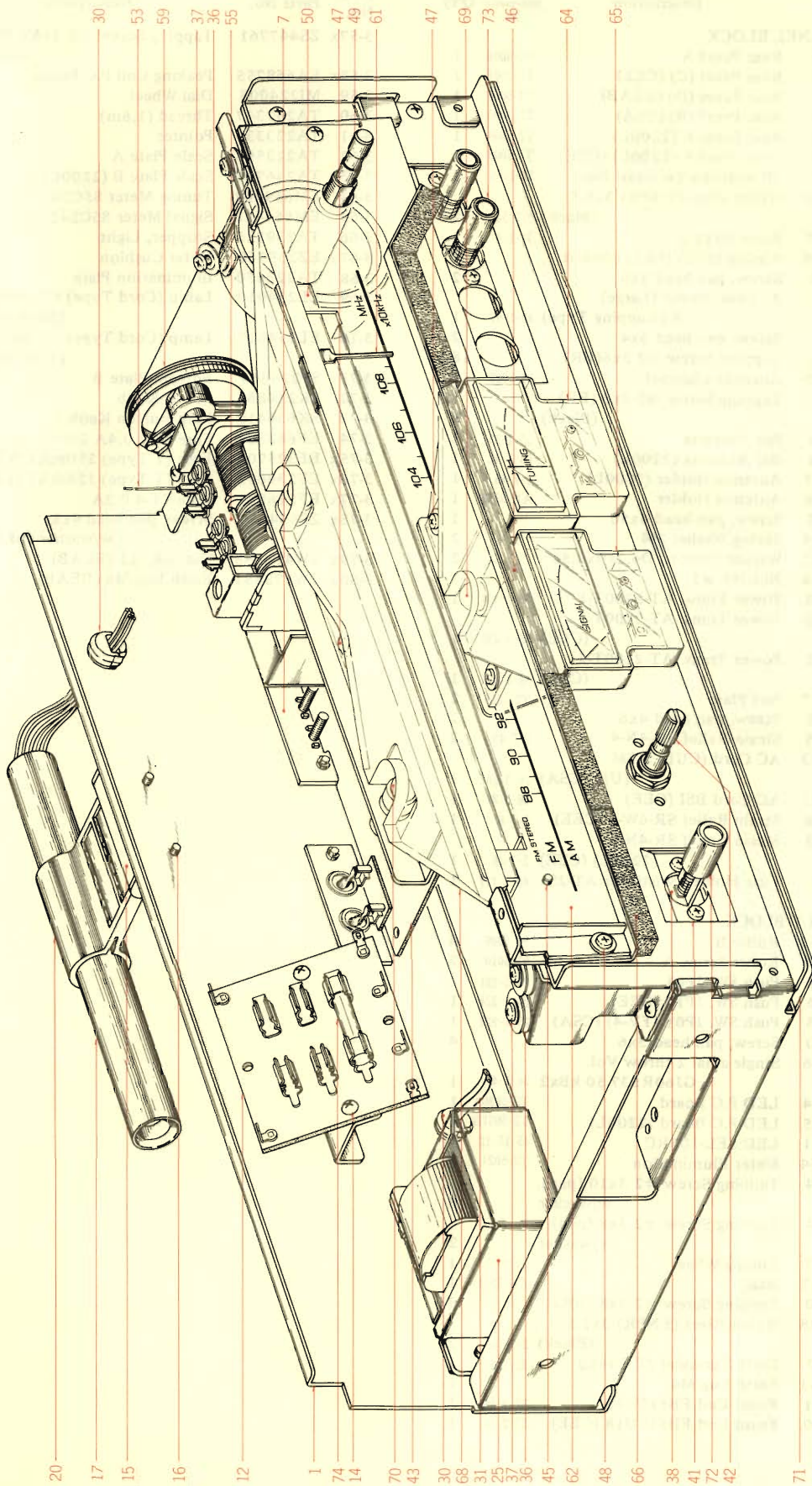

3.) ASSEMBLY BLOCK

Ref. No.	Parts No.	Description	Schematic No.	Q'ty	Ref. No.	Parts No.	Description	Schematic No.	Q'ty
REAR PANEL BLOCK									
3-1	SP223626	Rear Panel A	T2-5006	1	3-57x	ZS447761	Tapping Screw #2 3x6 (BR) (Black)		4
3-2x	SP247037	Rear Panel (C) (CEE)	T2-5006	1	3-58x	EA668755	Peaking Coil P.C Board	AA-5063	1
3-3x	SP243011	Rear Panel (D) (BEAB)	T2-5006	1	3-59	MI224008	Dial Wheel	2-15-15	1
3-4x	SP247004	Rear Panel (B) (CSA)	T2-5006	1	3-60	TA207347	Thread (1.6m)		1
3-5x	SP239310	Rear Panel E (2200L)	T2-5006	1	3-61	TA223334	Pointer	T2-5025	1
3-6x	SP239343	Rear Panel F (2200L) (CEE)	T2-5006	1	3-62	TA223593	Scale Plate A	T2-5004	1
3-7	EZ655187	5P Antenna Terminal Plate	32-1-69	1	3-63	TA246745	Scale Plate B (2200L)	T2-5004	1
3-8x	ZW698308	Nylon Rivet (FNPR) 3x5.5 (Black)	2-7-54	2	3-64	EM664402	Tuning Meter 85C243	46-1-115	1
3-9x	SK652397	Knob 0512-2	34-1-4	1	3-65	EM664413	Signal Meter 85C242	46-1-114	1
3-10x	ZW652408	Washer (SPC) D3.2x10x0.5t		1	3-66	TA239725	Stopper, Light	T2-5032	2
3-11x	ZS355522	Screw, pan head 3x6		2	3-67x	EZ239760	Meter Cushion	T2-5033	2
3-12	EJ223514	3P Fuse Holder (Large) A (Lupping Type)	40-1-97	1	3-68	TA223650	Illumination Plate	T2-5017	1
3-13x	ZS608477	Screw, pan head 3x4		2	3-69	EL224010	Lamp (Cord Type) 8V 300 mA (200mmx2)	28-2-53	1
3-14	ZS325495	Tapping Screw #2 3x6(BR)		18	3-70	EL214817	Lamp (Cord Type) 8V 300 mA (300mmx2)	28-2-54	2
3-15	TA530910	Antenna Channel	91-5029	1	3-71	SP224864	Bottom Plate B	M2-5014	1
3-16	ZS447761	Tapping Screw #2 3x6 (BR) (Black)		4	3-72	SK224886	Power Knob	M2-5021	1
3-17	EE223481	Bar Antenna	55-1-33	1	3-73	SK634410	Push Button Knob J	91-5051	2
3-18x	EE239321	Bar Antenna (2200L)	55-1-42	1	3-74	EF683324	Fuse SS-2 0.4A 250V	39-1-56	1
3-19x	TA625847	Antenna Holder (2200L)	2-7-46	1	3-75x	EF375704	Fuse (T Type) 250mAT (CEE)		2
3-20	TA378268	Antenna Holder	AA-5552	1	3-76x	EF239602	Fuse (T Type) 125mAT (CEE)		1
3-21x	ZS552600	Screw, pan head 4x50		1	3-77x	EF516881	Fuse ST-4 0.3A	39-1-28	3
3-22x	ZW273914	Spring Washer M4		2	3-78x	ZS434250	Screw, pan head 4x8, w/washer (BEAB)		1
3-23x	ZW420682	Washer (Nylon) D4.2x9x0.5t		2	3-79x	ZW413188	Nut M4, #1 (BEAB)		1
3-24x	ZW328588	Nut M4 #1		1	3-80x	ZW273881	Earth Lug M4 (BEAB)		1
3-25	BT223470	Power Trans. AT-2200T-1	38-4-434	1					
3-26x	BT215032	Power Trans. AT-2200T-3 (CEE)	38-4-436	1					
3-27x	BT215021	Power Trans. AT-2200T-2 (CSA)	38-4-435	1					
3-28	MZ223277	Nut Plate	T2-5009	2					
3-29	ZS201778	Screw, pan head 4x8		2					
3-30	EZ631945	Strain Relief SR-4N-4	2-7-49	2					
3-31	EW540123	AC Cord (CUL) 2.5M (U/T, CSA)	26-3-20	1					
3-32x	EW604585	AC Cord BSI (CEE)	26-3-37	1					
3-33x	EZ246936	Strain Relief SR-6W-1 (CEE)	2-7-8	1					
3-34x	EZ631945	Strain Relief SR-4N-4 (2200L) (CEE)	2-7-49	1					
3-35x	EJ244552	Fuse Holder, w/sticker AT-2S	40-1-117	1					
ASSEMBLY BLOCK									
3-36	MR530662	Roller B	91-5009	4					
3-37	ZS530673	Roller Screw A	91-5010	2					
3-38	ES224436	Push SW. JP01	25-5-221	1					
3-39x	ES242346	Push SW. JP17 (CEE)	25-5-224	1					
3-40x	ES239218	Push SW. JP01 (TV-4) (CSA)	25-5-222	1					
3-41	ZS379350	Screw, pan head 3x6		4					
3-42	EV223986	Single axial 2 throw Vol. GJ60R537 50 kBx2	36-1-49	1					
3-43	EA223424	LED P.C Board	T2-5020A	1					
3-44x	EA239635	LED P.C Board (2200L)	T2-5031B	1					
3-45	ED694091	LED SEL-105RC	45-15-12	1					
3-46	MZ223154	Meter Illumination	T2-5024	1					
3-47	ZS225134	Tapping Screw #2 3x10 (pan), w/washer		3					
3-48	ZS462194	Tapping Screw #2 3x8 (pan), w/washer		2					
3-49	MI223997	Tuning Wheel	13-2-5	1					
3-50	TA646367	Rail	AA-5234	1					
3-51x	ZS447840	Tapping Screw #2 3x8 (BR)		3					
3-52x	ZW698308	Nylon Rivet (FNPR) 3x5.5 (Black)	2-7-54	2					
3-53	EJ539447	Earth Terminal 2P T4460	32-1-32	1					
3-54x	ZW273881	Earth Lug M4		1					
3-55	EE655001	Front End FB512U13	57-2-35	1					
3-56x	EE215100	Front End FB512U18 (CEE)	57-2-38	1					

When ordering parts, please describe Parts Number, Description, and Model Number in detail.

4. PHOTO OF FINAL ASSEMBLY BLOCK

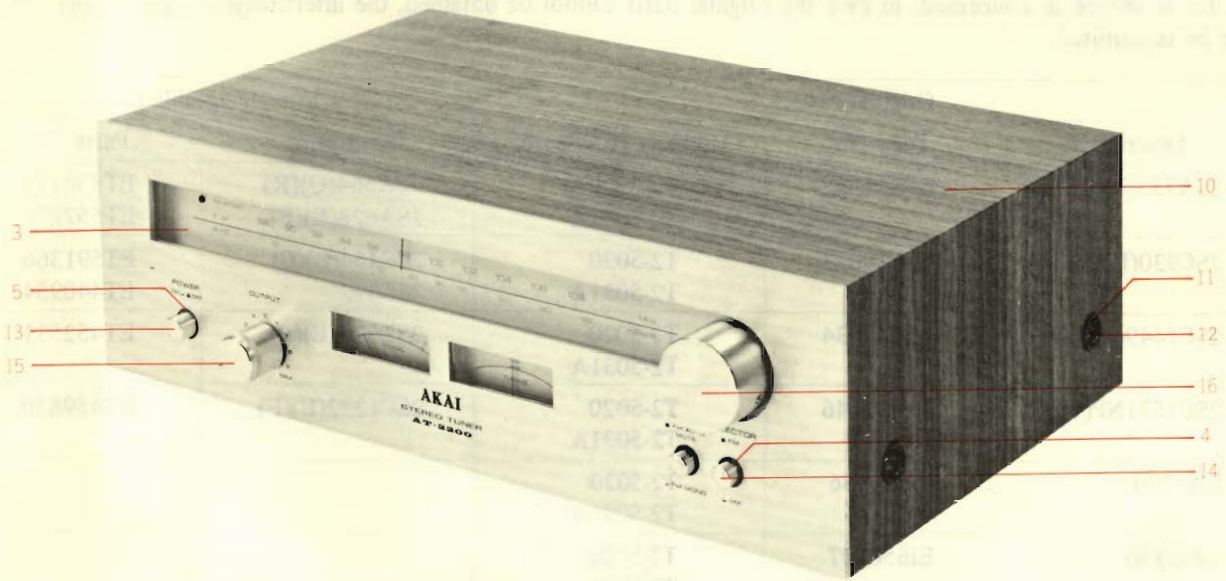

4. FINAL ASSEMBLY BLOCK

Ref. No.	Parts No.	Description	Schematic No.	Q'ty
FRONT PANEL BLOCK				
4-1x	BD211162	Front Panel Block Comp.		1
4-2x	BD270887	Front Panel Block Comp. (2200L)		1
4-3	TA223672	Acrylic Plate	T2-5014	1
4-4	SE613888	Button Escutcheon A	CW-6021	2
4-5x	MZ224627	Push Button Bush A	M2-5004	1
ASSEMBLY BLOCK				
4-6x	ZW224087	Adjust. Washer D4.5x10x0.5t		2
4-7x	ZW224144	Adjust. Washer D4.5x10x0.4t		2
4-8x	SZ645243	Circular Foot A	CA-6014	4
4-9x	ZS565942	Tapping Screw #2 4x8 (PAN)		4
4-10	BC224820	Cabinet B	M2-5013	1
4-11	ZW548010	Spot Facing Washer	MU-6028	4
4-12	ZS558090	Screw, binding head 4x14		4
4-13	SK224886	Power Knob	M2-5021	1
4-14	SK634410	Push Button Knob J	91-5051	2
4-15	SK646817	Single Knob	AA-5250	1
4-16	SK223705	Tuning Knob	T2-5019	1

5. LIST OF INTERCHANGEABLE SEMICONDUCTORS

As far as service in concerned, in case the original parts cannot be obtained, the interchangeable parts listed below can be substituted.

Original Parts			Interchangeable Parts	
Description	Parts No.	Utilizing P.C Board	Description	Parts No.
2SA733(P)(Q)(R)	ET539122	T2-5020 T2-5031A	2SA564(Q)(R) 2SA628(E)(F)	ET538154 ET557976
2SC930(E)(F)	ET618873	T2-5020 T2-5031A	2SC454(B)(C) 2SC372	ET591366 ET440954
2SC1449(K)(L)	ET649034	T2-5020 T2-5031A	2SD313(E)(F)	ET452531
2SC1571NP(G)(H)	ET223446	T2-5020 T2-5031A	2SC1222(E)(F)	ET459810
LA1230	EI650586	T2-5020 T2-5031A		
LA-3350	EI650597	T2-5020 T2-5031A		
μ PC30C	EI650362	T2-5020 T2-5031A		
SEL-105RC	ED694091	T2-5020A T2-5031B		
1S2473	ED624903	T2-5020 T2-5031A	1S2473VE 1S1588	ED560913 ED557447
RD13E	ED223558	T2-5020 T2-5031A	WZ130	ED539976
DS131A	ED223547	T2-5020 T2-5031A	10DC1(BLK)	ED329130
1N34A	ED219464	T2-5020 T2-5031A	1S188AM 1N60	ED562386 ED428264

INDEX

Parts No.	Ref. No. & Symbol No.	Parts No.	Ref. No. & Symbol No.	Parts No.	Ref. No. & Symbol No.	Parts No.	Ref. No. & Symbol No.	Parts No.	Ref. No. & Symbol No.
BA211184	2-1	SE613888	4-4						
BA270898	2-2	SK223705	4-16						
BC224820	4-10	SK224886	3-72						
BD211162	4-1x	SK224886	4-13						
BD270887	4-2x	SK634410	3-73						
BT215021	3-27x	SK634410	4-14						
BT215032	3-26x	SK646817	4-15						
BT223470	3-25	SK652397	3-9x						
EA223424	3-43	SP223626	3-1						
EA239635	3-44x	SP224864	3-71						
EA668755	3-58x	SP239310	3-5x						
EC215065	2-C22	SP239343	3-6x						
EC223413	2-C23	SP243011	3-3x						
EC223560	2-C48	SP247004	3-4x						
EC223582	2-C21	SP247037	3-2x						
EC650406	2-C38	SZ645243	4-8x						
EC650406	2-C59	TA207347	3-60						
EC666483	2-C20	TA223334	3-61						
EC675742	2-VC1,2	TA223593	3-62						
ED219464	2-D5	TA223650	3-58						
ED223547	2-D4	TA223672	4-3						
ED223558	2-D3	TA239725	3-66						
ED624903	2-D1,2	TA246745	3-63						
ED694091	3-45	TA378268	3-20						
EE215100	3-56x	TA530910	3-15						
EE223481	3-17	TA625847	3-19x						
EE239321	3-18x	TA646367	3-50						
EE655301	3-55	ZS201778	3-29						
EF239602	3-76x	ZS225134	3-47						
EF375704	3-75x	ZS325495	2-3						
EF516881	3-77x	ZS325495	3-14						
EF683324	3-74	ZS355522	3-11x						
EI650362	2-IC3	ZS379350	3-41						
EI650586	2-IC1	ZS434250	3-78x						
EI650597	2-IC2	ZS447761	3-16x						
EJ223457	2-J1	ZS447761	3-57x						
EJ223514	3-12	ZS447840	3-51x						
EJ244552	3-35x	ZS462194	3-48						
E 539447	3-53	ZS530673	3-37						
EL 14817	3-70	ZS552600	3-21						
EL224010	3-69	ZS558090	4-12						
EM664402	3-64	ZS565942	4-9x						
EM664413	3-65	ZS608477	3-13x						
EO239308	2-T3	ZW224087	4-6x						
EO539820	2-L1,2	ZW224144	4-7x						
EO650373	2-T3	ZW273881	3-54x						
EO650373	2-T4	ZW273881	3-80x						
EO650384	2-T4	ZW273914	3-22x						
EO650384	2-T5	ZW328588	3-24x						
EO650395	2-T2	ZW413188	3-79x						
EO650428	2-L4,5	ZW420682	3-23x						
EO650608	2-T1	ZW548010	4-11						
EO650610	2-L3	ZW652408	3-10x						
ER650430	2-FL1,2	ZW698308	3-8x						
ES223468	2-SW1	ZW698308	3-52x						
ES224436	3-38								
ES239218	3-40x								
ES239297	2-SW1								
ES242346	3-39x								
ET223446	2-TR2,3								
ET539122	2-TR4								
ET618873	2-TR1								
ET649034	2-TR5								
EV223986	3-42								
EV484863	2-VR3								
EV499364	2-VR2								
EV550023	2-VR1								
EW540123	3-31								
EW604585	3-32x								
EZ239760	3-67x								
EZ246936	3-33x								
EZ631945	3-30								
EZ631945	3-34x								
EZ655187	3-7								
MI223997	3-49								
MI224008	3-59								
MR530662	3-36								
MZ223154	3-46								
MZ223277	3-28								
MZ224627	4-5								

Page	Description	Page	Description
1540402A	AT-2200 SCHEMATIC DIAGRAM	1540403A	AT-2200/L SCHEMATIC DIAGRAM
1540404A	AT-2200/L FRONT END SCHEMATIC DIAGRAM		

SECTION 3

SCHEMATIC DIAGRAM

- 1. AT-2200 SCHEMATIC DIAGRAM 1540402A
- 2. AT-2200/L SCHEMATIC DIAGRAM 1540403A
- 3. AT-2200/L FRONT END SCHEMATIC DIAGRAM 1540404A

AT-2200

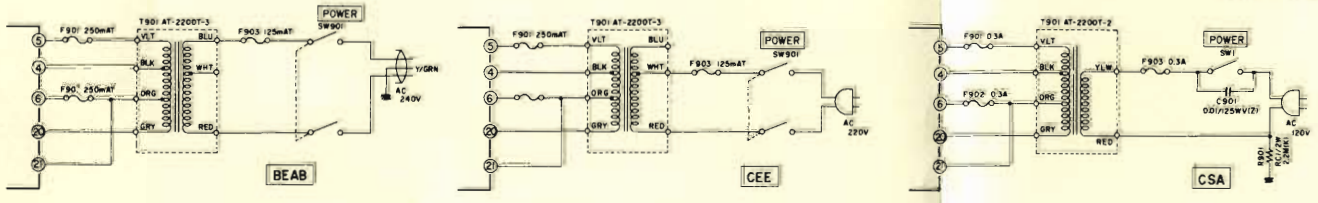
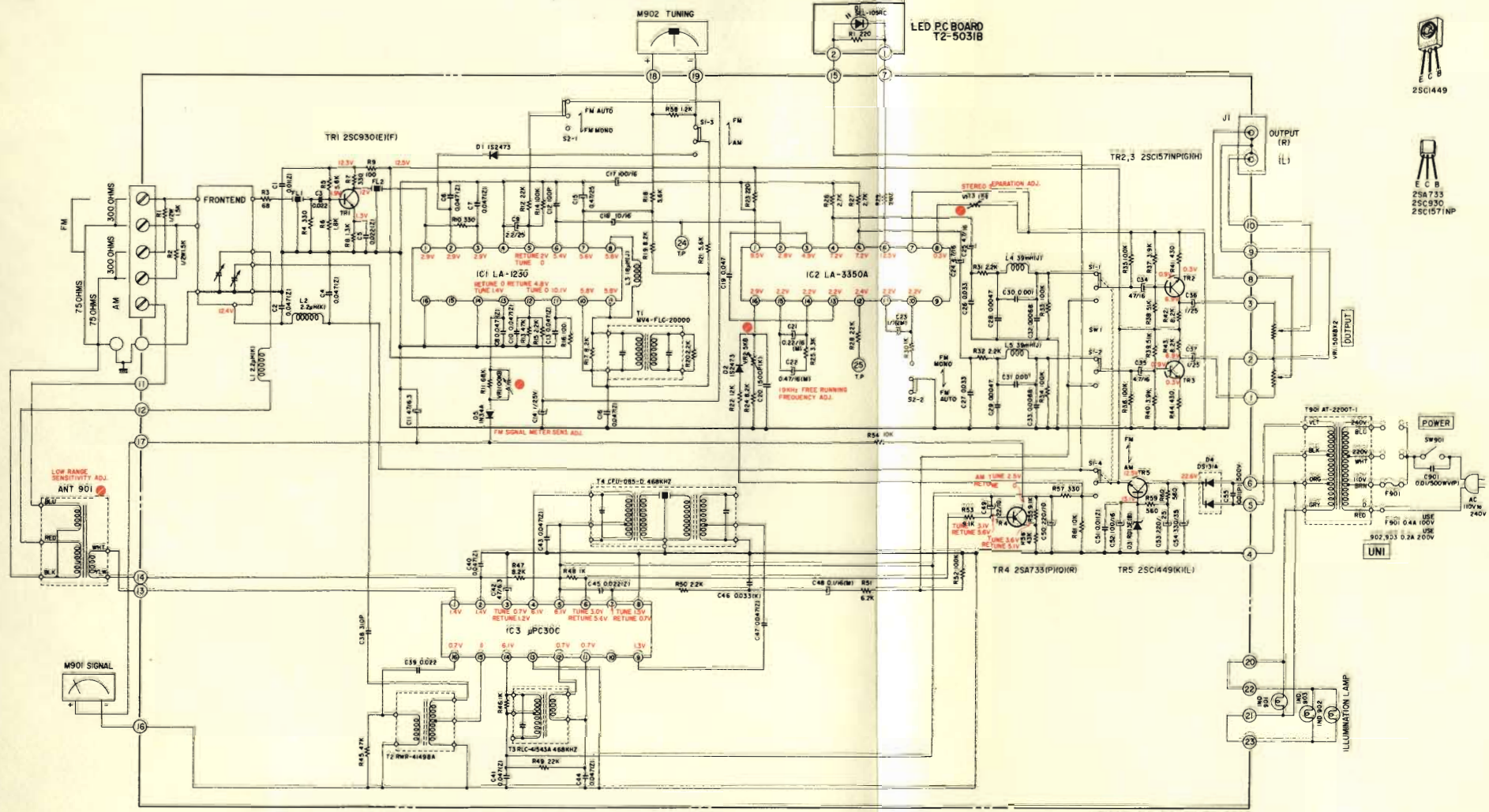

NOTE
 1 UNLESS OTHERWISE SPECIFIED
 ALL RESISTORS IN OHMS (1/4W, 1%)
 ALL CAPACITORS IN μF (50V, 10%)
 2 POWER TRANSFORMER IS DIFFERENT
 ACCORDING TO AREA
 3 VOLTAGE OF IC3 AND TR4 AT AM MODE

AT-2200
 SCHEMATIC DIAGRAM
 No.3-1 1540402A

AT-2200L

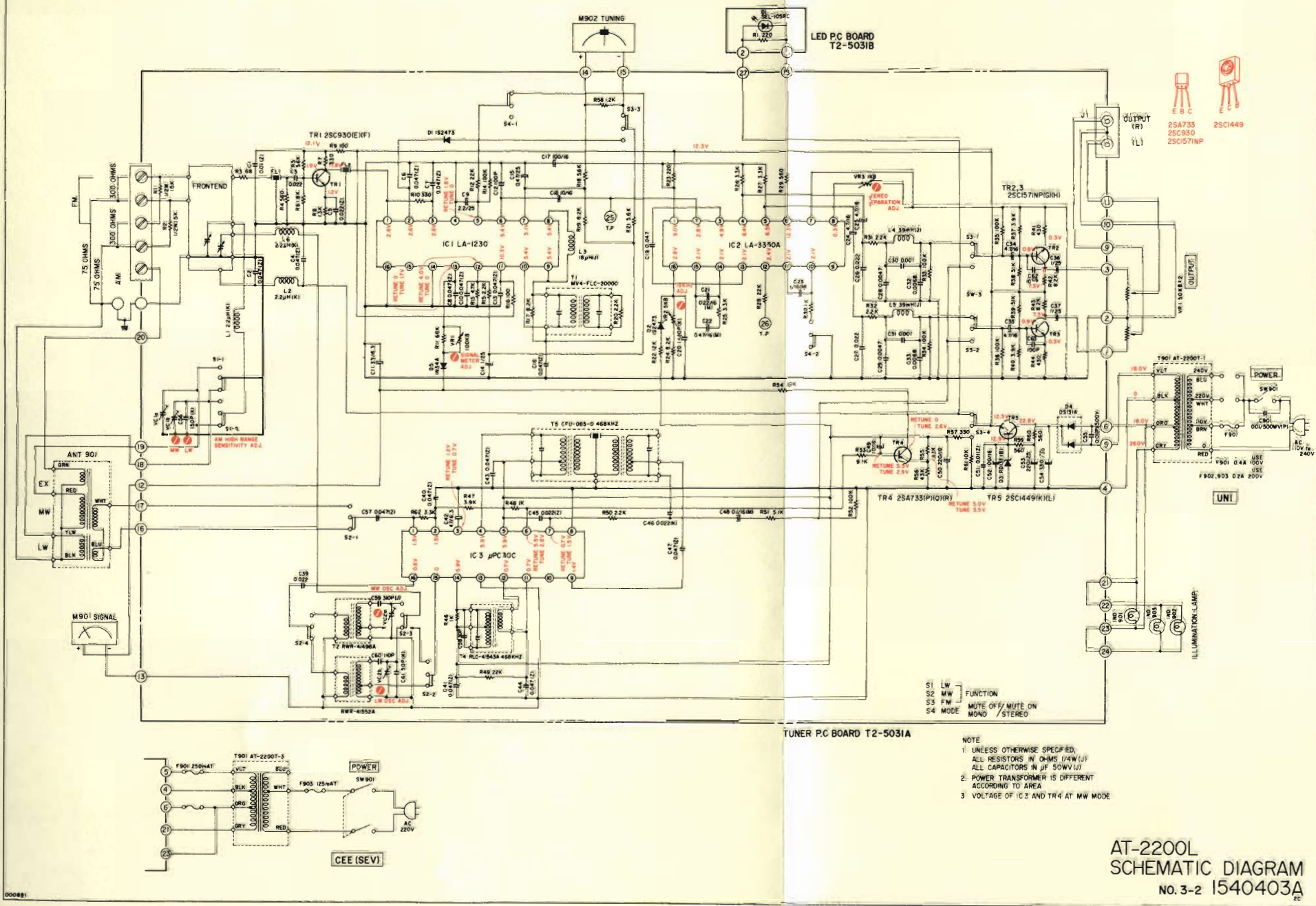

000831

AT-2200

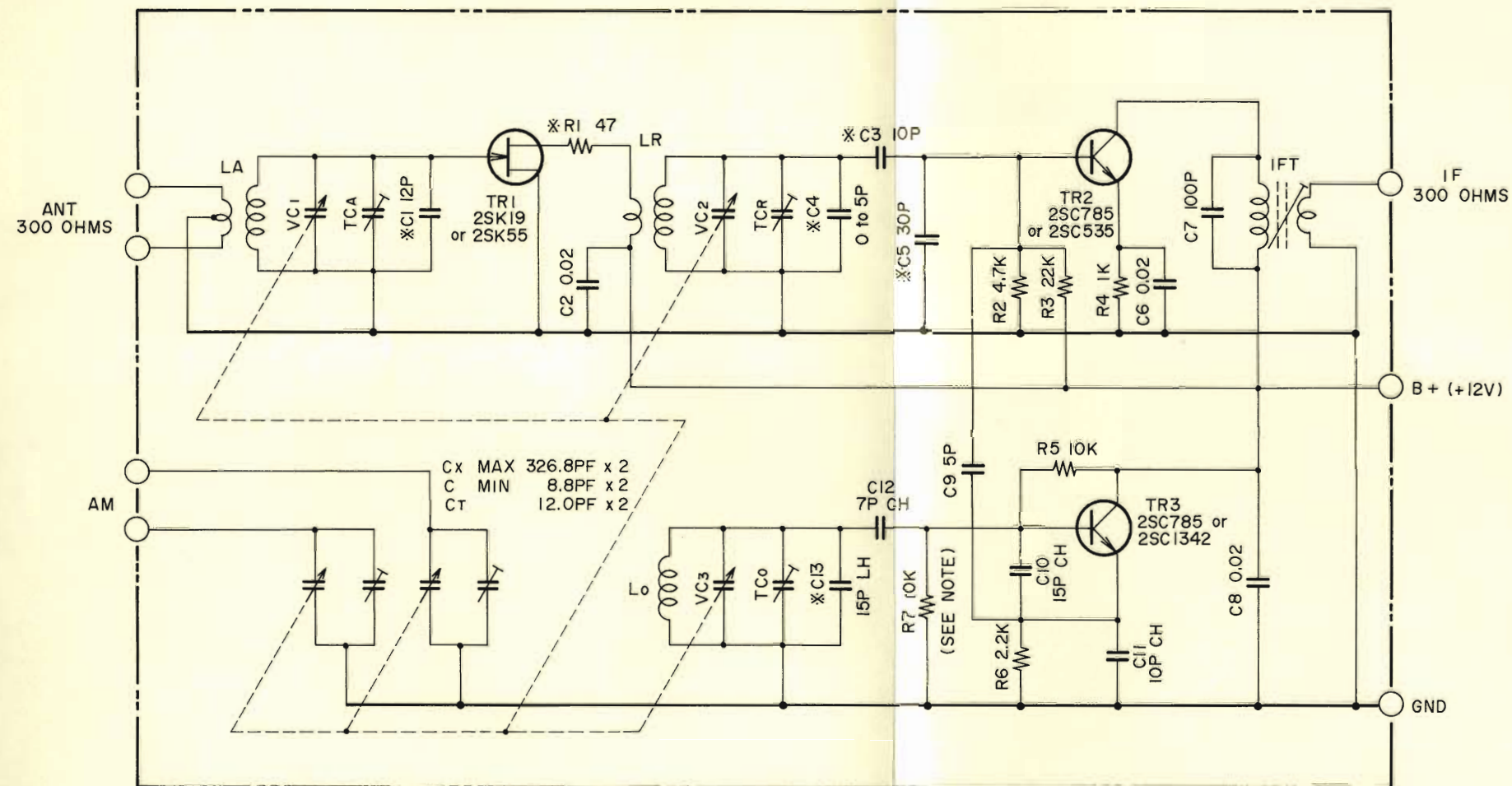

NOTE
 1. UNLESS OTHERWISE SPECIFIED
 ALL RESISTORS IN OHMS
 ALL CAPACITORS IN μ F
 2. * MARK : FACTORY ADJUSTED
 3. R7 : 6.4K OHMS (CEE MODEL)
 4 MODEL AT-2200(CEE) : FB512U18
 MODEL AT-2200(OTHER) : FB512U14

AT-2200/L
 FRONT END
 SCHEMATIC DIAGRAM
 No.3-3 1540404A

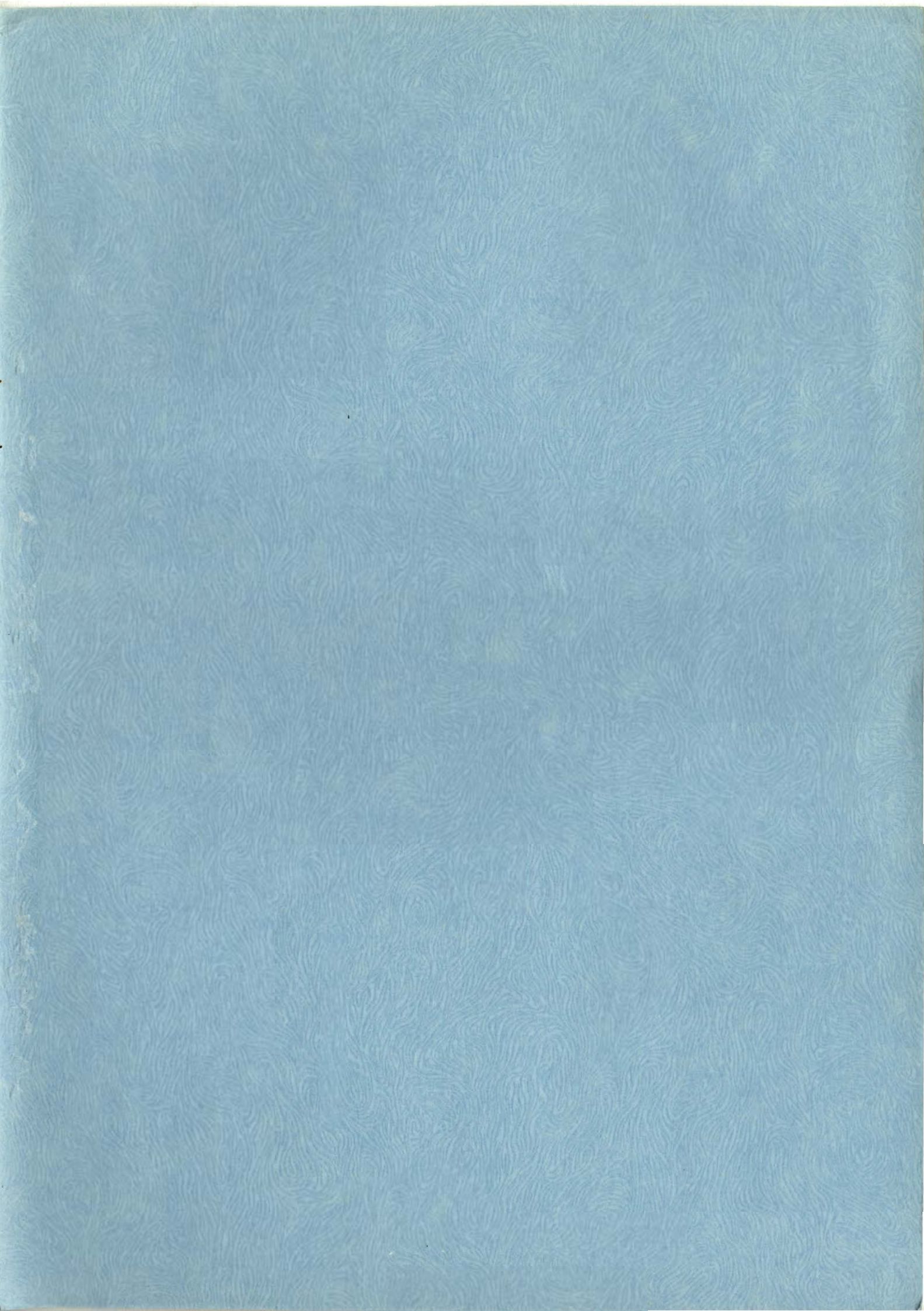

 **AKAI ELECTRIC CO., LTD.**
AKAI TRADING CO., LTD.

(P.O. BOX 21, Tokyo International Airport, Japan)
12-14, 2-chome, Higashi-Kojiya, Ohta-ku, Tokyo, Japan
TELEPHONE: TOKYO (742) 5111
CABLE: HIFI AKAI TOKYO TELEX: J26261

Printed No. 1540406K1 Printed in Japan