

AKAI

MODEL **AT-M400/L**

MODEL **AT-M600/L**

SCHEMATIC DIAGRAMS AND PC BOARDS

TABLE OF CONTENTS

1. AT-M400/L BLOCK DIAGRAM	2
2. AT-M600/L BLOCK DIAGRAM	3
3. MAIN AND OTHER PC BOARDS	4
4. AT-M400 SCHEMATIC DIAGRAM	5
5. AT-M400L SCHEMATIC DIAGRAM	6
6. MAIN AND OTHER PC BOARDS	7
7. MAIN AND OTHER PC BOARDS	8
8. AT-M600 SCHEMATIC DIAGRAM	9
9. AT-M600L SCHEMATIC DIAGRAM	10
10. MAIN AND OTHER PC BOARDS	11
11. INFORMATION OF ICs	12

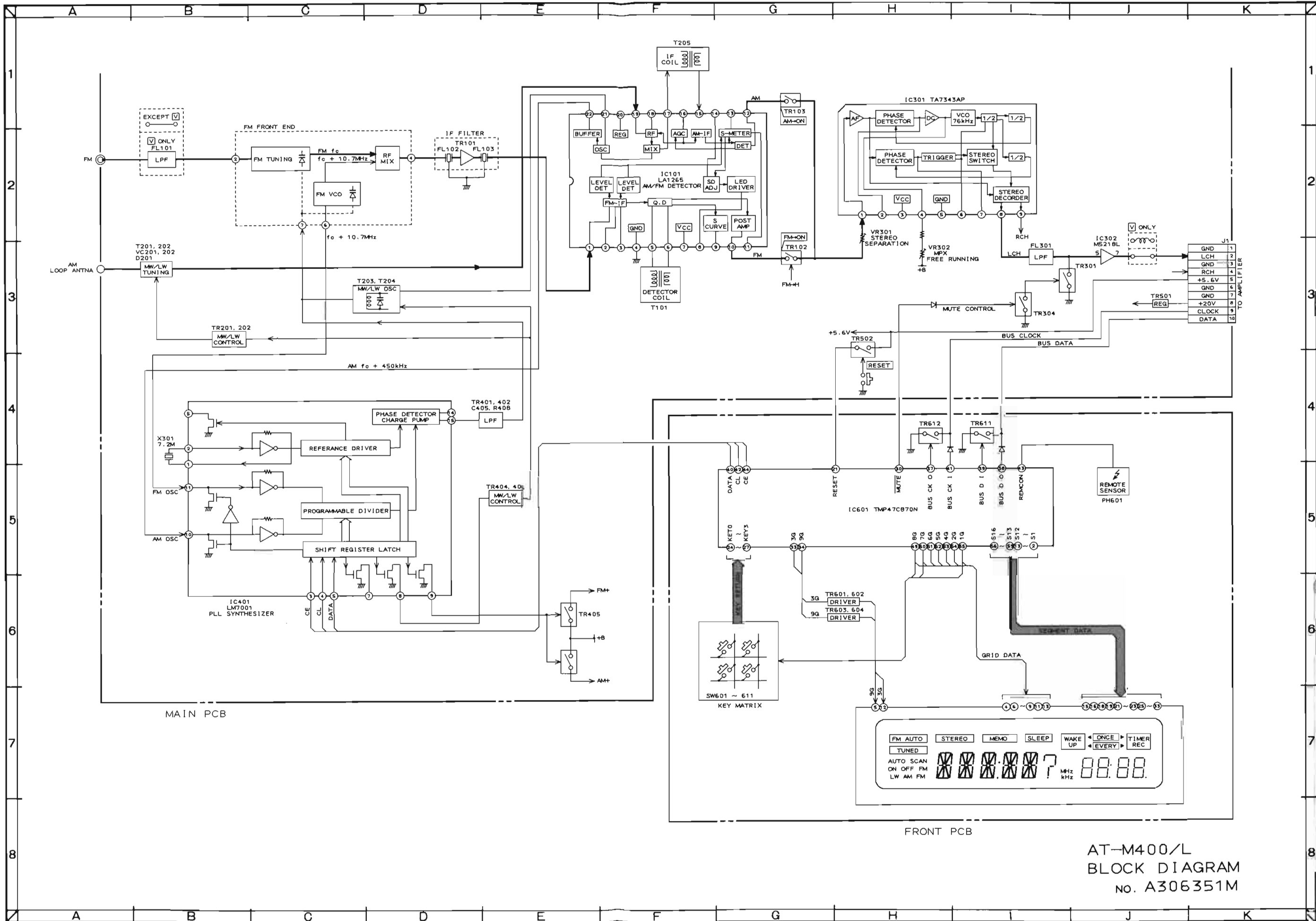

AT-M400/L
BLOCK DIAGRAM
NO. A306351M

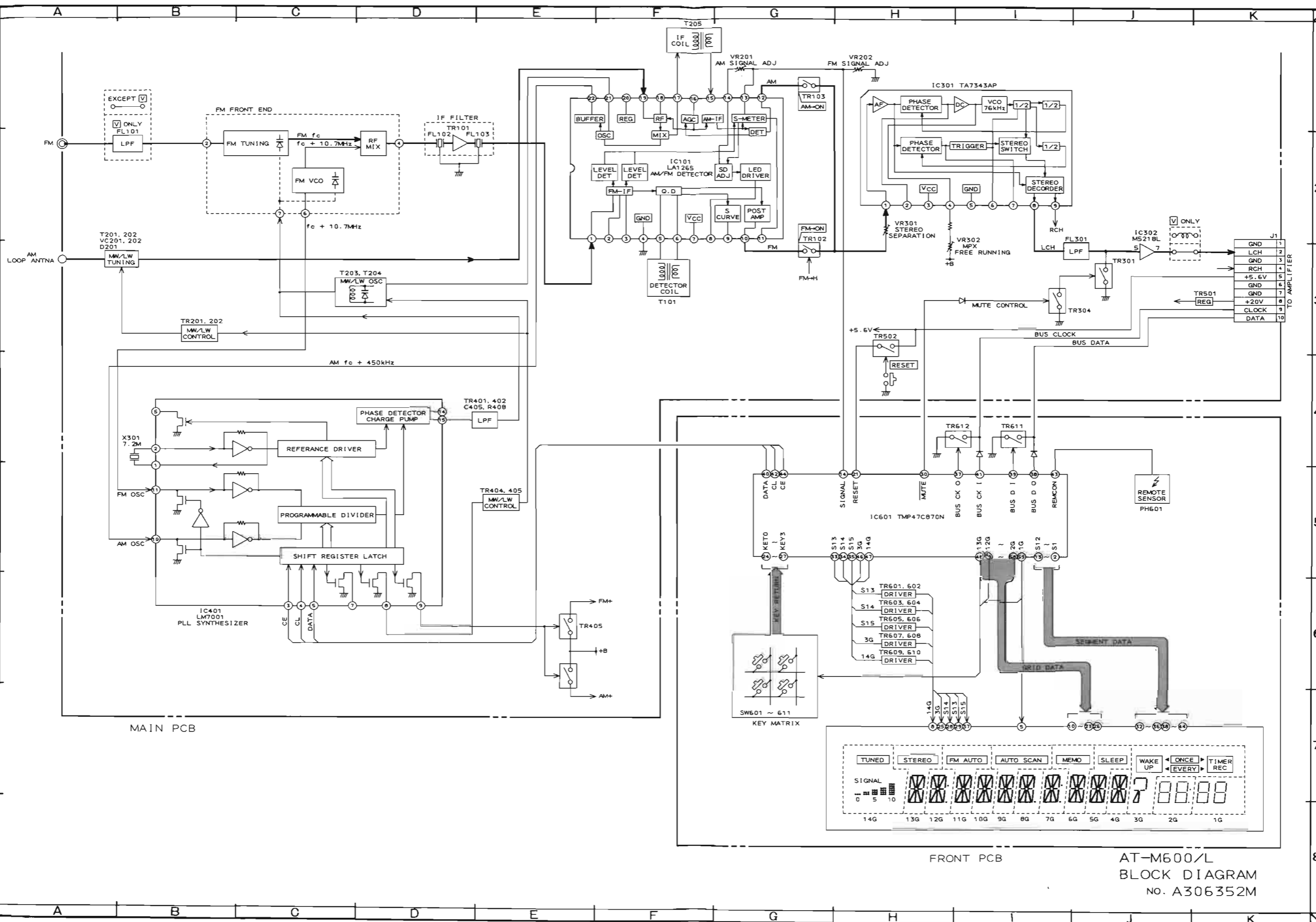

AT-M600/L
BLOCK DIAGRAM
No. A306352M

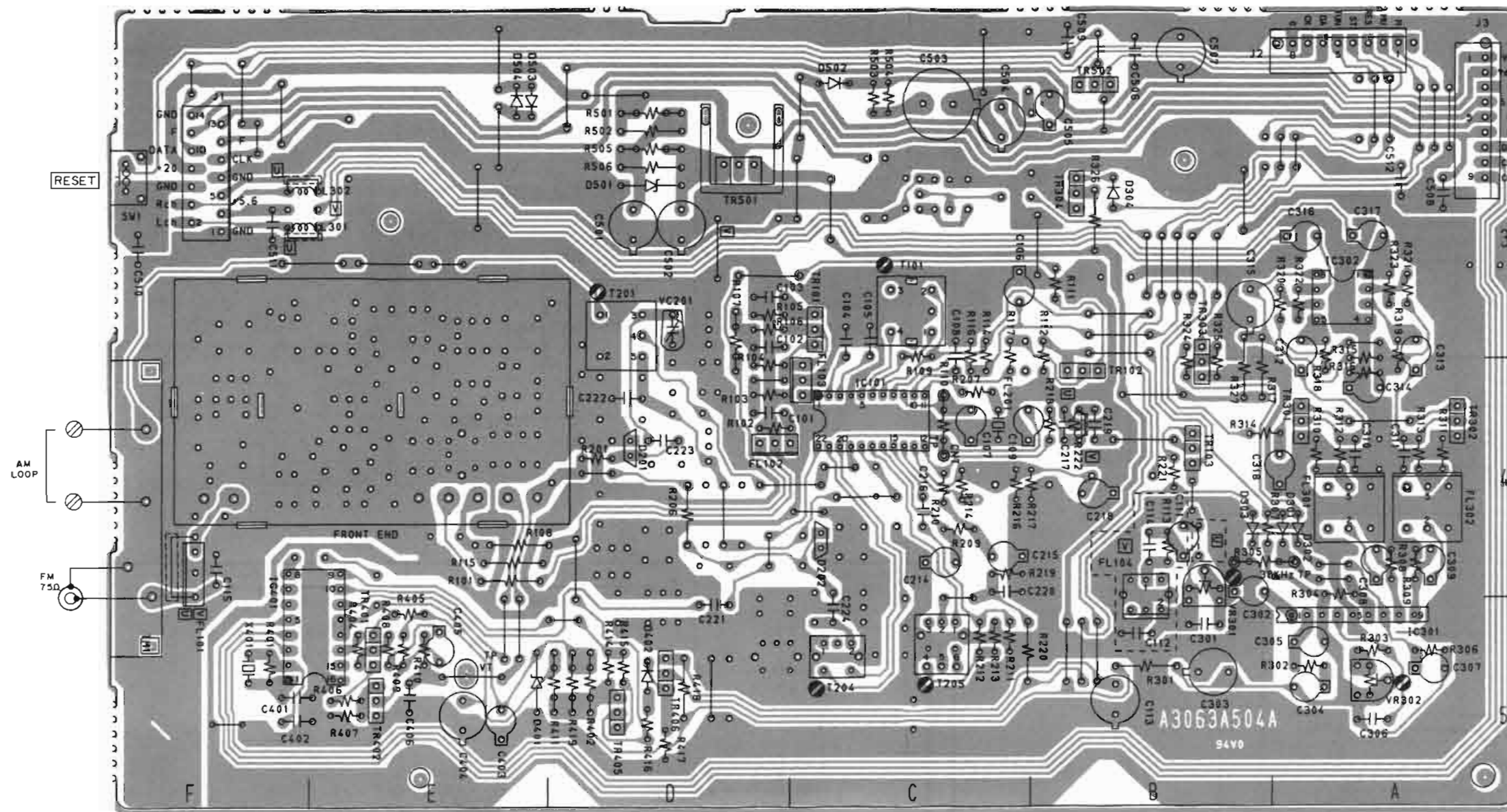

MAIN PCB A3063A504A U V Model

PRINCIPAL PARTS LOCATION

- ICs
 IC101.....C4
 IC301.....A5
 IC302.....A3
 IC401.....E, F5

CONNECTORS

- J1.....F3
 J2.....A3
 J3.....A3

TRANSISTORS

- TR101.....C3
 TR102.....B4
 TR103.....B4
 TR301.....A4
 TR302.....A4
 TR303.....B3, 4
 TR304.....B3
 TR401.....E5
 TR402.....E5
 TR405.....D5
 TR406.....D5
 TR501.....D3
 TR502.....B3

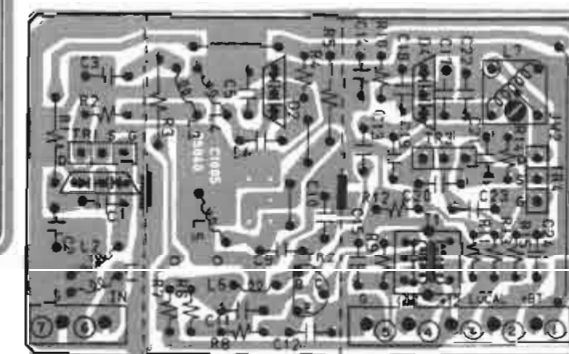

FRONT END PCB

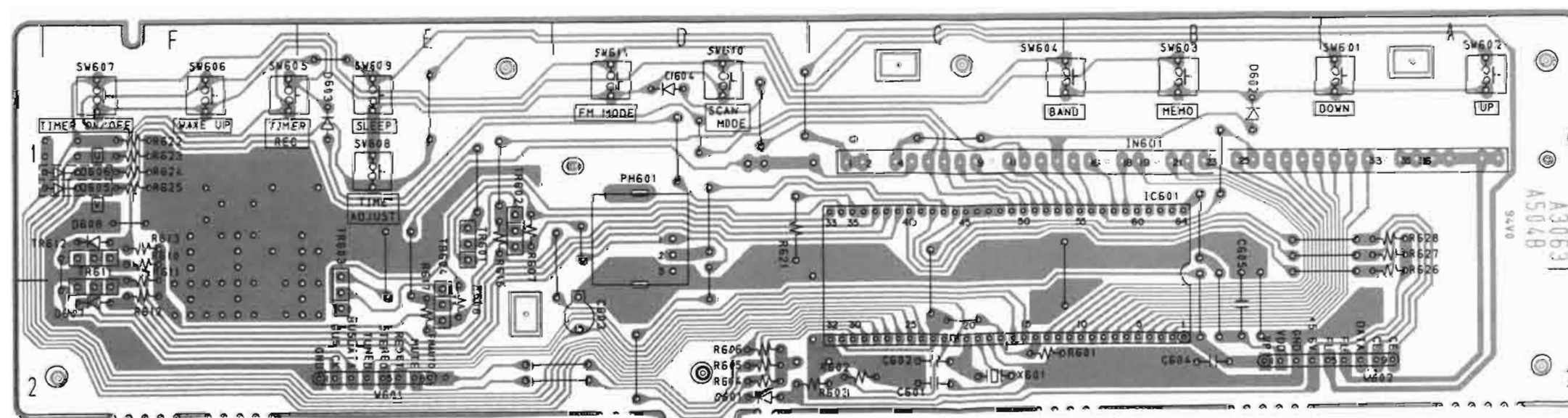

FRONT PCB A3063A504B U V Model

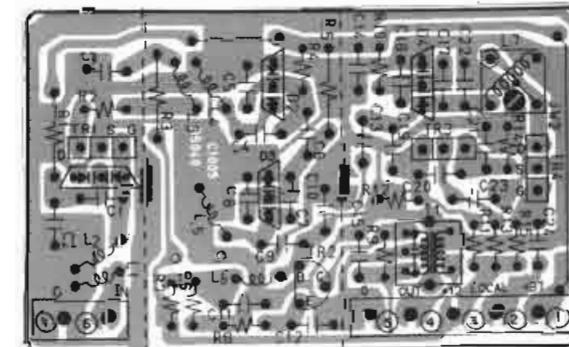

FRONT END PCB
 V MODEL ONLY

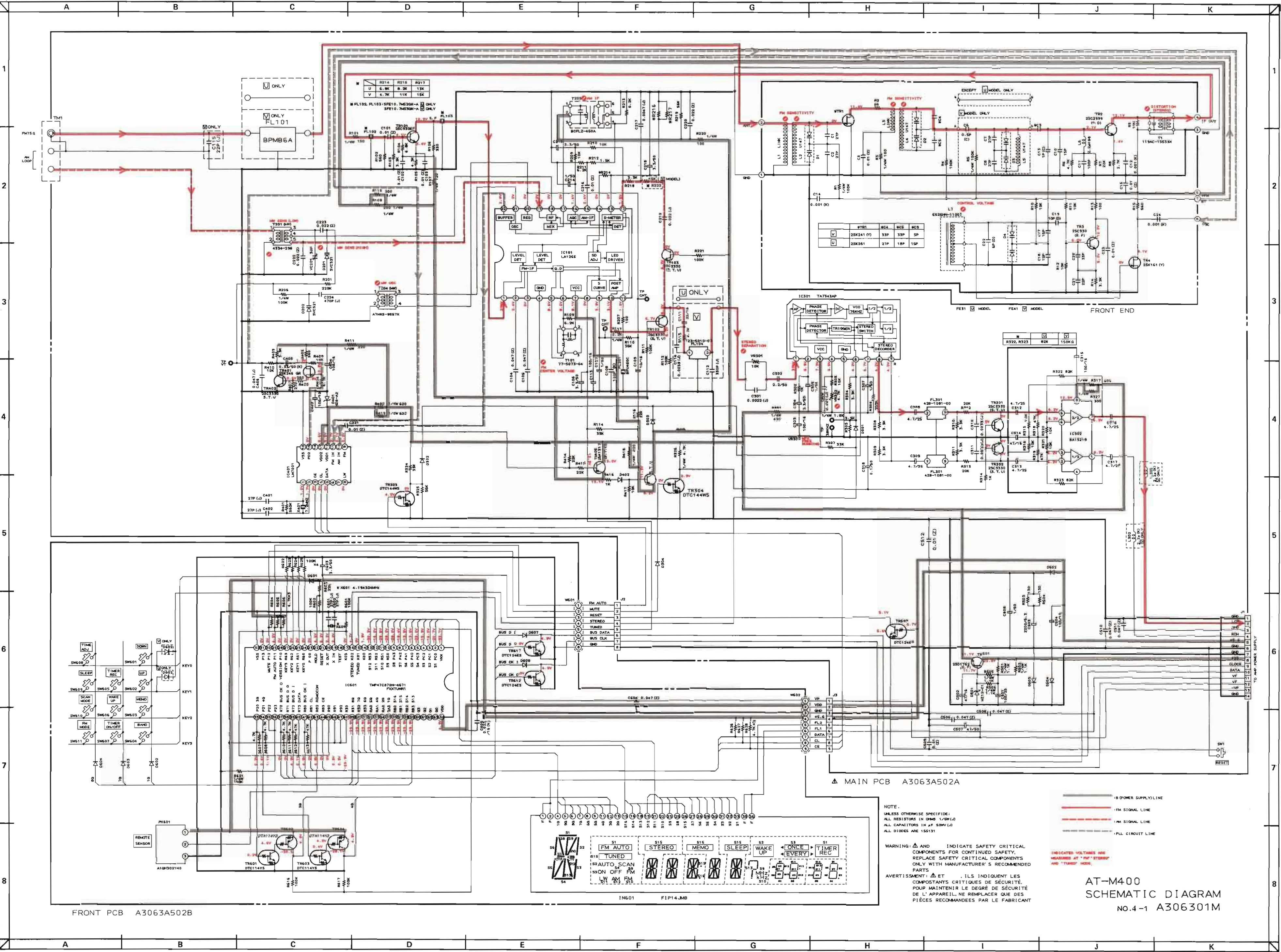

M	R214	R215	R217
U	6.8K	0.2K	13K
V	4.7K	11K	15K

MAIN PCB A3063A502A

FRONT PCB A3063A502B

NOTE:
UNLESS OTHERWISE SPECIFIED:
ALL RESISTORS IN OHMS 1/8W (J)
ALL CAPACITORS IN μF 50V (J)
ALL DIODES ARE 1SS131

— 18 POWER SUPPLY LINE
— FM SIGNAL LINE
— FM SIGNAL LINE
— PLL CIRCUIT LINE

WARNING: Δ AND INDICATE SAFETY CRITICAL COMPONENTS FOR CONTINUED SAFETY. REPLACE SAFETY CRITICAL COMPONENTS ONLY WITH MANUFACTURER'S RECOMMENDED PARTS.
AVERTISSEMENT: Δ ET COMPOSANTS CRITIQUES DE SÉCURITÉ. POUR MAINTENIR LE DEGRÉ DE SÉCURITÉ DE L'APPAREIL, NE REMPLACER QUE DES PIÈCES RECOMMANDÉES PAR LE FABRICANT.

AT-M400
SCHEMATIC DIAGRAM
No.4-1 A306301M

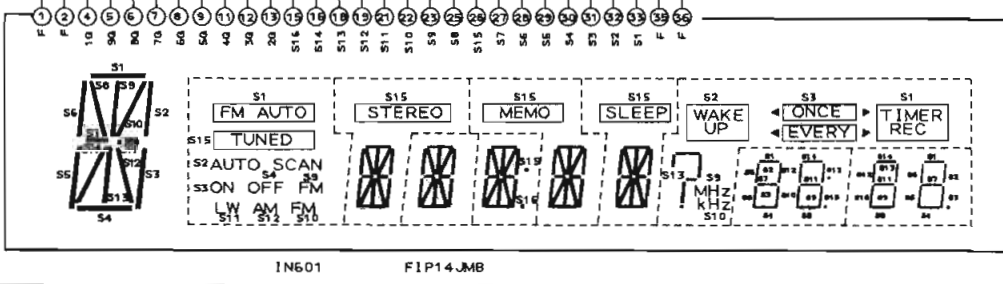

TO AMP POWER SUPPLY

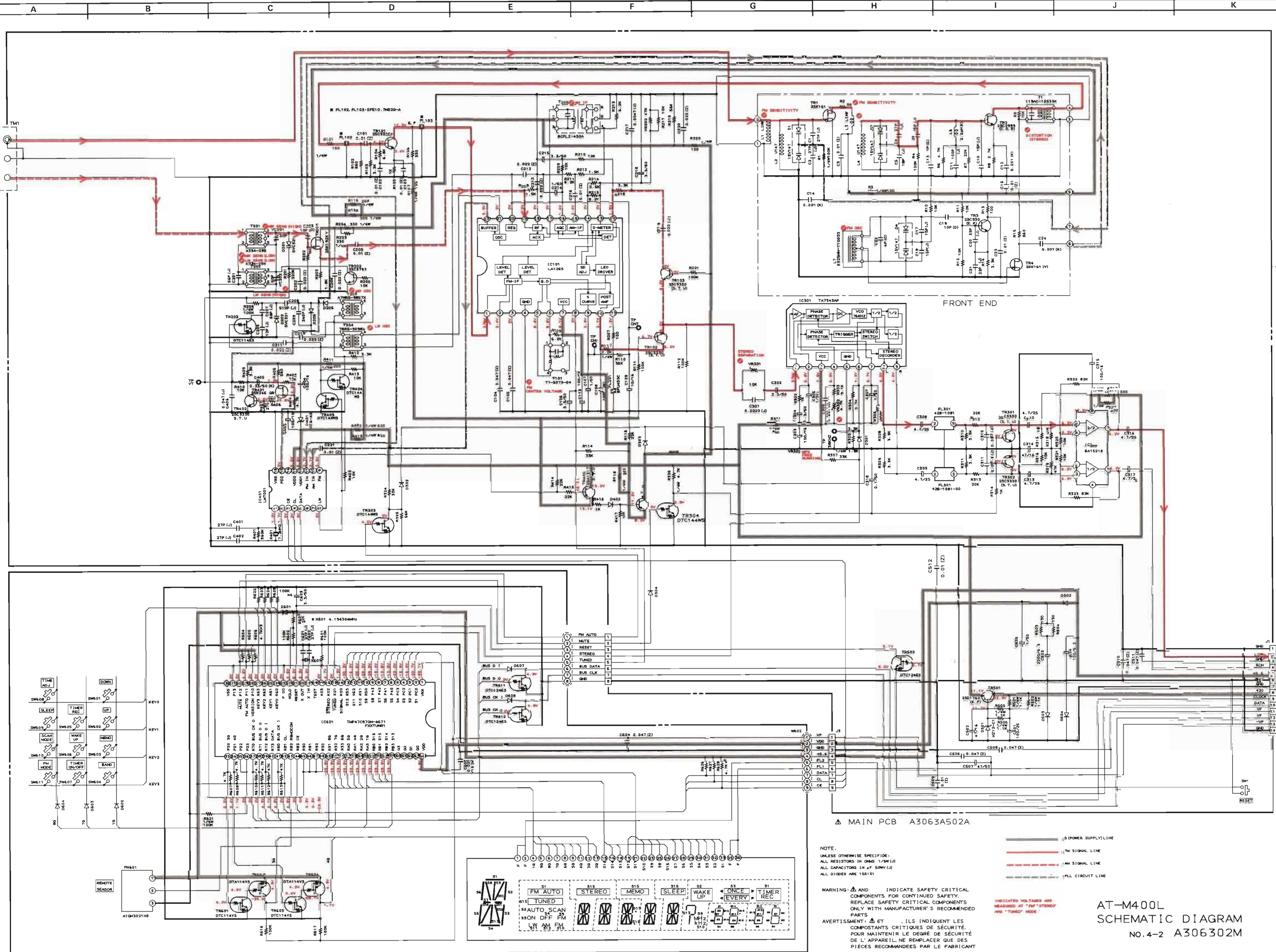

▲ MAIN PCB A3063A502A

NOTE:
 UNLESS OTHERWISE SPECIFIED:
 ALL RESISTORS IN OHMS (Ω), KΩ (K), MΩ (M)
 ALL CAPACITORS IN μF (μ), N (N), P (P)
 ALL DIODES ARE 1N5131

WARNING: ▲ AND △ INDICATE SAFETY CRITICAL COMPONENTS FOR CONTINUED SAFETY. REPLACE SAFETY CRITICAL COMPONENTS ONLY WITH MANUFACTURER'S RECOMMENDED PARTS.
 AVERTISSEMENT: ▲ ET △ ILS INDIQUENT LES COMPOSANTS CRITIQUES DE SÉCURITÉ. POUR MAINTENIR LE DEGRÉ DE SÉCURITÉ DE L'APPAREIL, NE REMPLACER QUE DES PIÈCES RECOMMANDÉES PAR LE FABRICANT

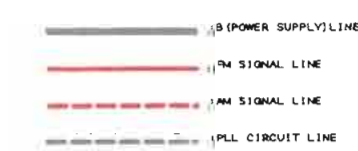

INDICATED VOLTAGES ARE MEASURED AT "FM" "STEREO" AND "TUNED" MODE

AT-M400L
 SCHEMATIC DIAGRAM
 NO. 4-2 A306302M

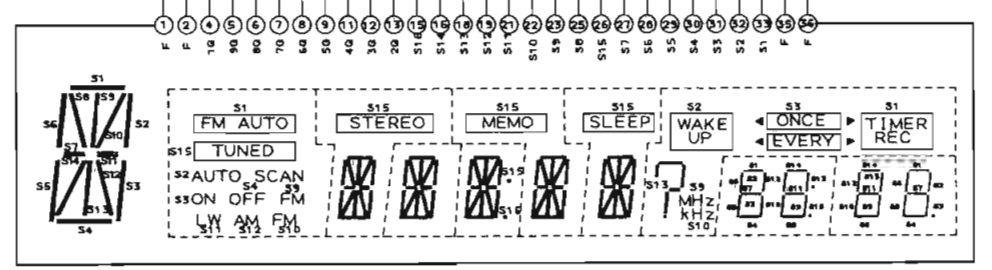

FRONT PCB A3063A502B

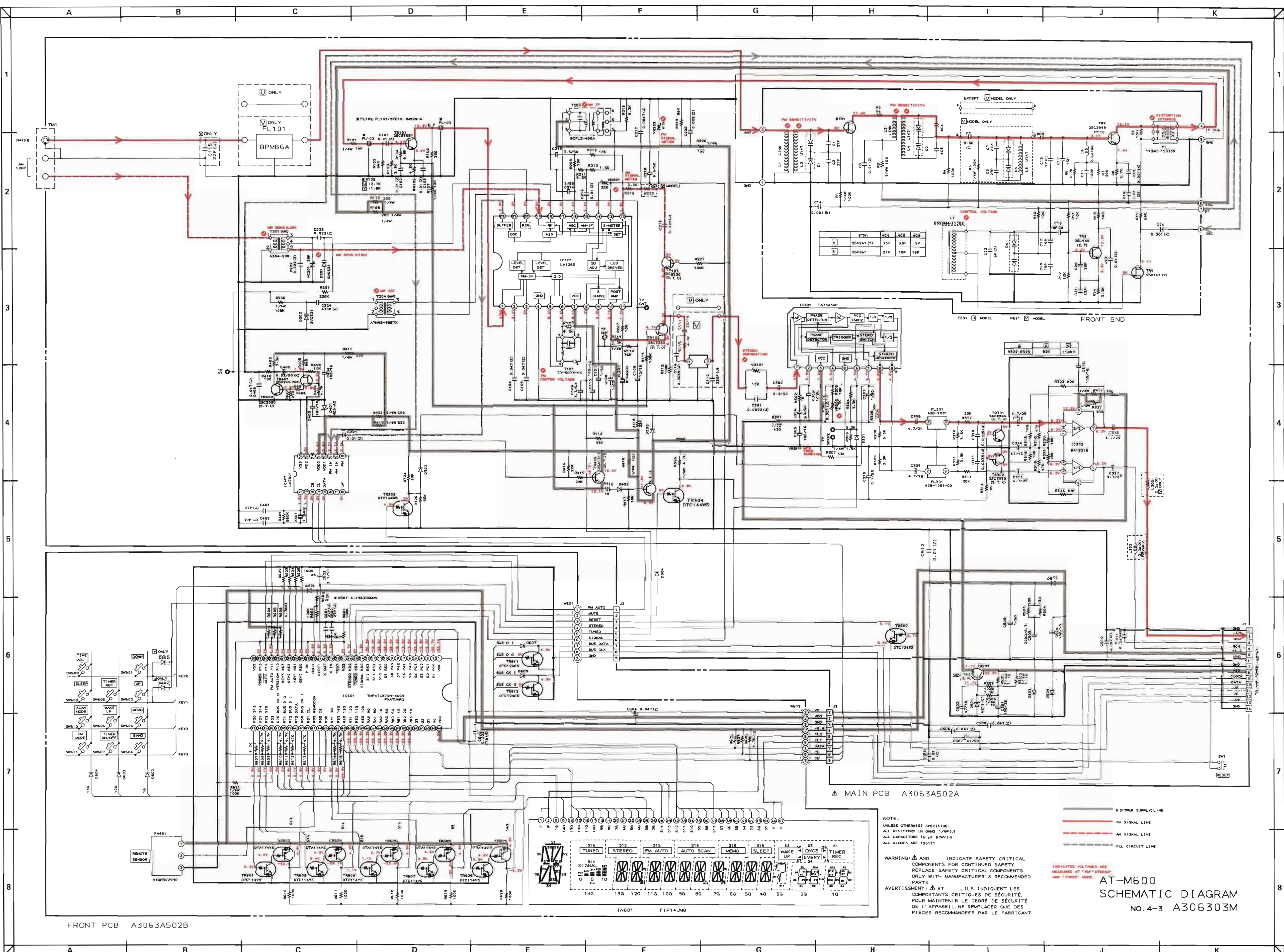

FRONT PCB A3063A502B

▲ MAIN PCB A3063A502A

NOTE:
UNLESS OTHERWISE SPECIFIED:
ALL RESISTORS IN OHMS 1/4W (1%)
ALL CAPACITORS IN P.F. 50WV (1%)
ALL DIODES ARE 1N5131

WARNING: ▲ INDICATE SAFETY CRITICAL COMPONENTS FOR CONTINUED SAFETY. REPLACE SAFETY CRITICAL COMPONENTS ONLY WITH MANUFACTURER'S RECOMMENDED PARTS.

AVERTISSEMENT: ▲ ET ... ILS INDIQUENT LES COMPOSANTS CRITIQUES DE SÉCURITÉ. POUR MAINTENIR LE DEGRÉ DE SÉCURITÉ DE L'APPAREIL, NE REMPLACER QUE DES PIÈCES RECOMMANDÉES PAR LE FABRICANT.

INDICATED VOLTAGES ARE MEASURED AT "FM" STEREO AND "TUNED" MODE.

AT-M600 SCHEMATIC DIAGRAM NO. 4-3 A306303M

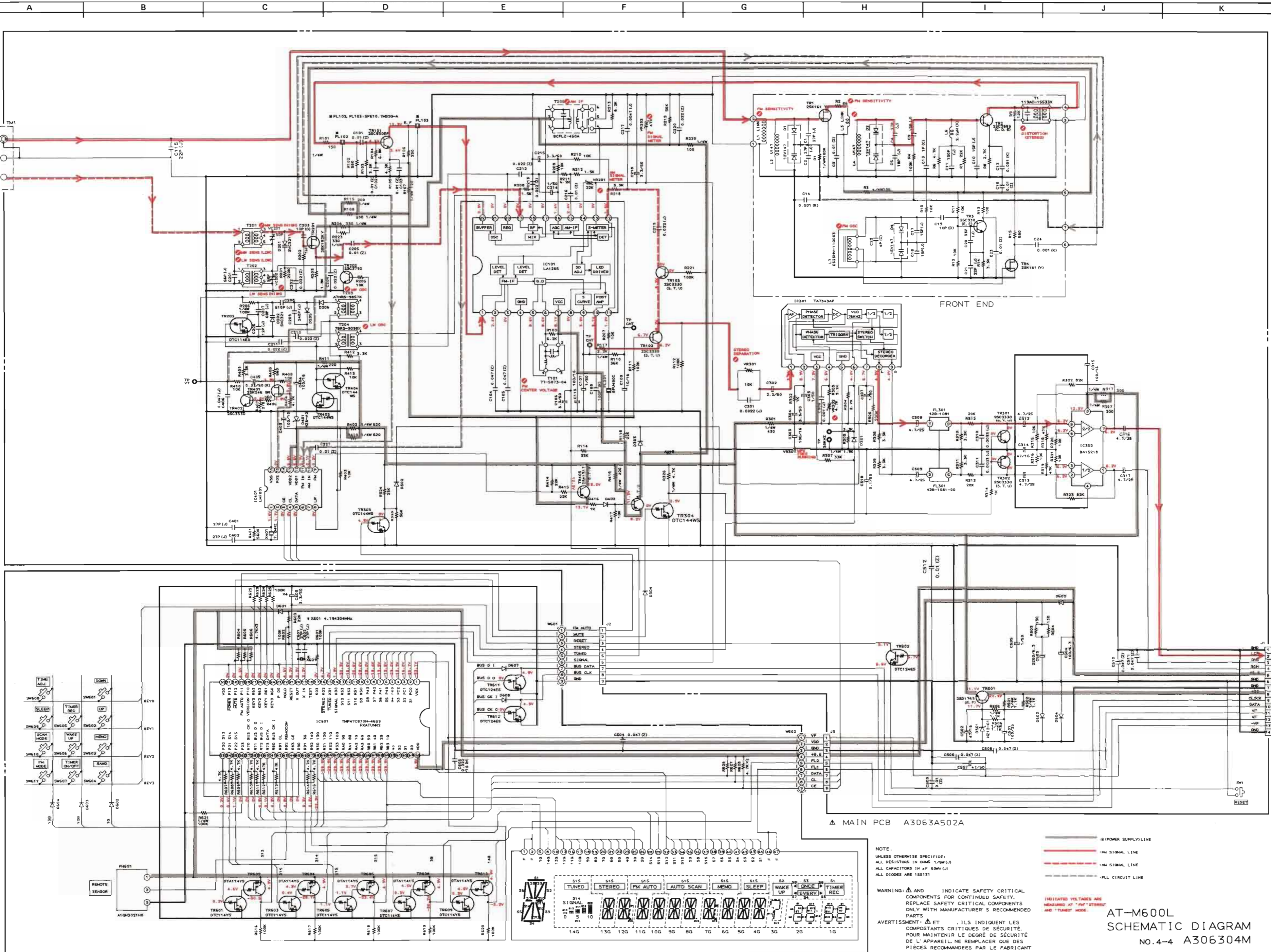

FRONT PCB A3063A502B

MAIN PCB A3063A502A

NOTE:
 UNLESS OTHERWISE SPECIFIED:
 ALL RESISTORS IN OHMS 1/4W (L)
 ALL CAPACITORS IN PF 50WV (L)
 ALL DIODES ARE 1N5131

WARNING: ⚠ AND ⚡ INDICATE SAFETY CRITICAL COMPONENTS FOR CONTINUED SAFETY. REPLACE SAFETY CRITICAL COMPONENTS ONLY WITH MANUFACTURER'S RECOMMENDED PARTS.
 AVERTISSEMENT: ⚠ ET ⚡ ILS INDICENT LES COMPOSANTS CRITIQUES DE SÉCURITÉ. POUR MAINTENIR LE DEGRÉ DE SÉCURITÉ DE L'APPAREIL, NE REMPLACER QUE DES PIÈCES RECOMMANDÉES PAR LE FABRICANT.

AT-M600L
 SCHEMATIC DIAGRAM
 NO.4-4 A306304M

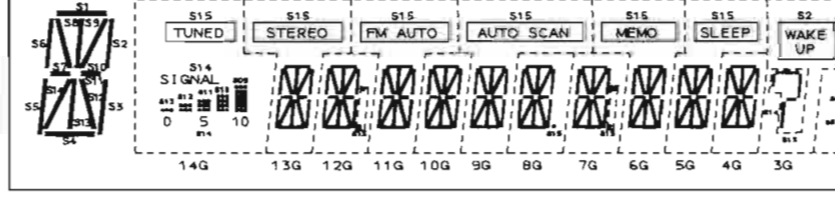

— B (POWER SUPPLY) LINE
 — FM SIGNAL LINE
 - - - AM SIGNAL LINE
 - - - PLL CIRCUIT LINE

INDICATED VOLTAGES ARE MEASURED AT "FM" STEREO AND "TUNED" MODE.

PRINCIPAL PARTS LOCATION

- ICS
 IC101.....C4
 IC301.....A5
 IC302.....A3
 IC401.....E, F4, 5

- CONNECTORS
 J1.....F3
 J2.....A3
 J3.....A3

- TRANSISTORS
 TR1.....F4
 TR2.....E4
 TR3.....E4
 TR4.....E4
 TR101.....C3
 TR102.....B4
 TR103.....B4
 TR201.....D4
 TR202.....D3
 TR203.....C5
 TR301.....A4
 TR302.....A4
 TR303.....B3, 4
 TR304.....B3
 TR401.....E5
 TR402.....E5
 TR403.....D4
 TR404.....D4
 TR405.....D5
 TR406.....D5
 TR501.....D3
 TR502.....B3

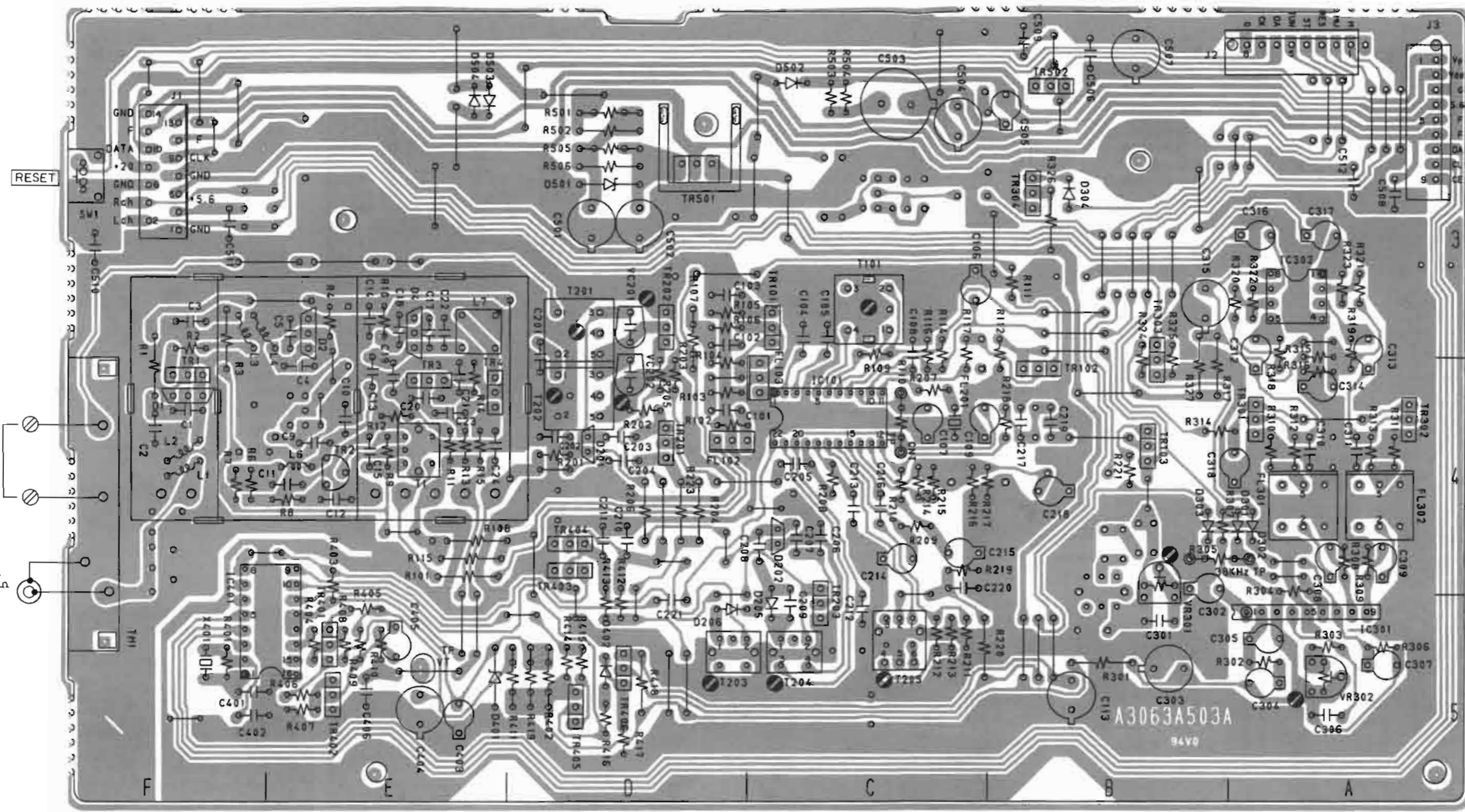

MAIN PCB E B Model

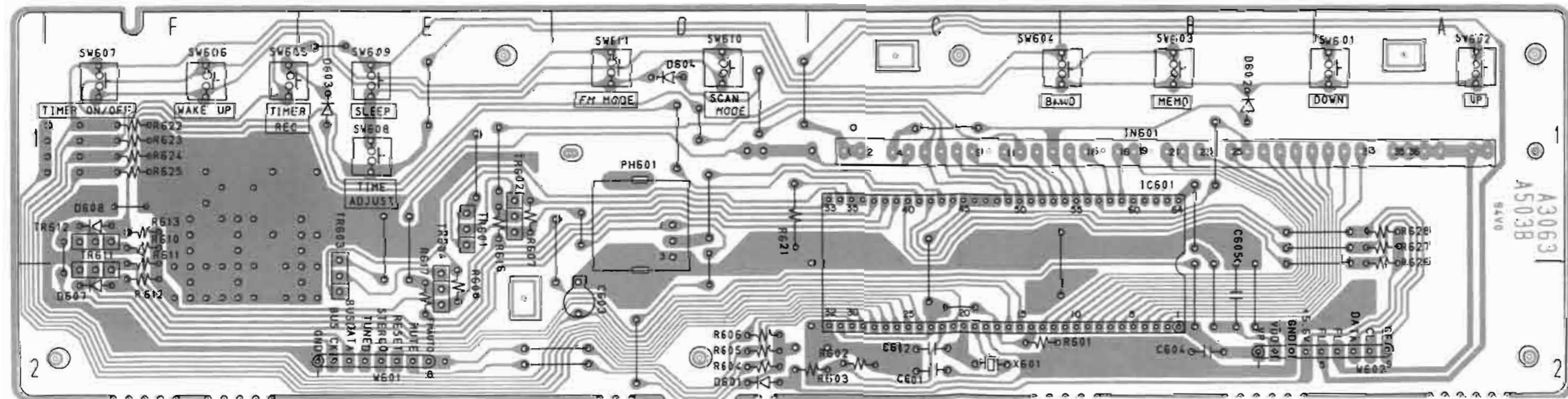

FRONT PCB A3063A503B E B Model

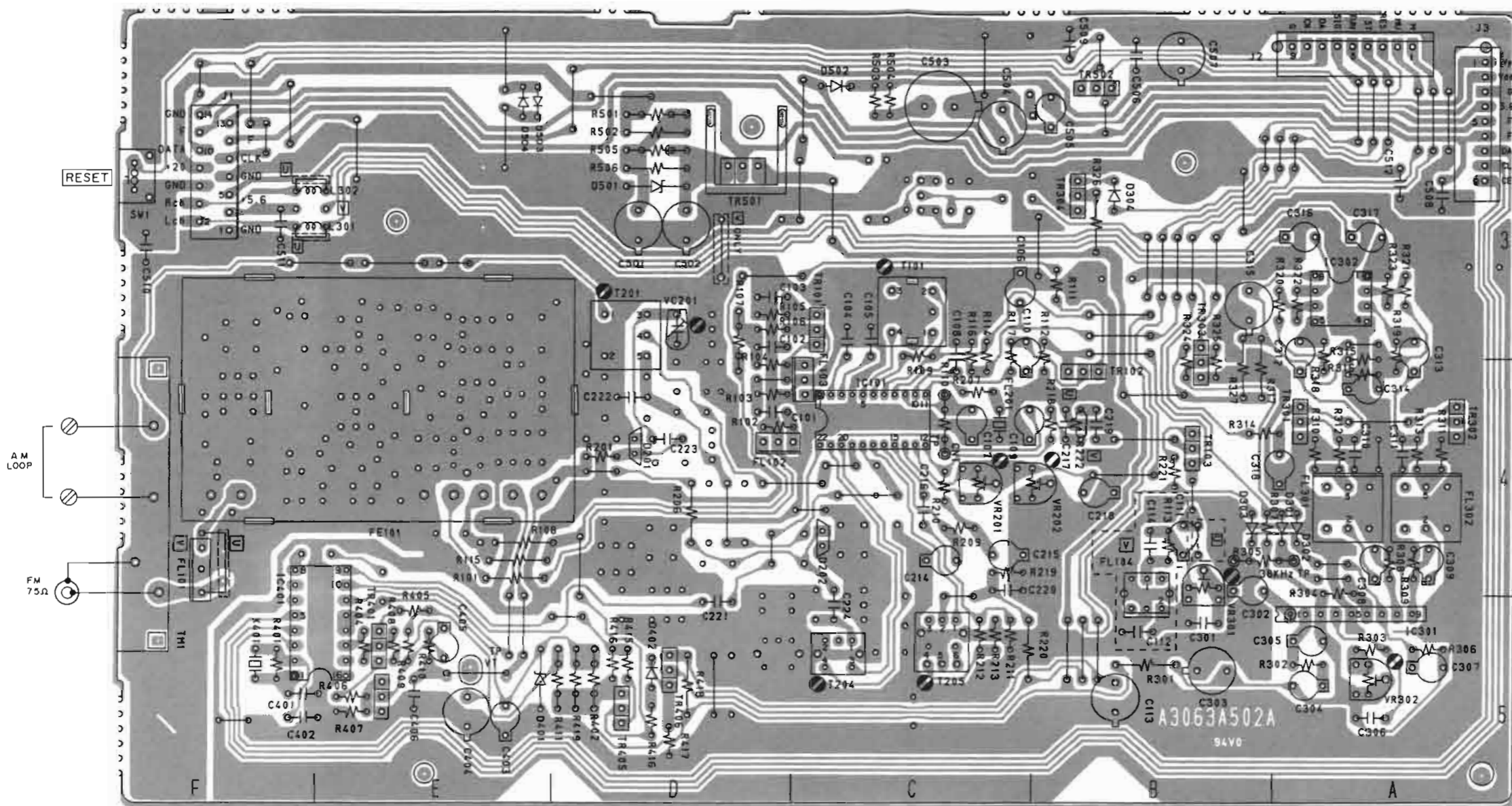

MAIN PCB A3063A502AJI Model

- PRINCIPAL PARTS LOCATION
- ICS
 IC101.....C4
 IC301.....A5
 IC302.....A3
 IC401.....E, F5
- CONNECTORS
 J1.....F3
 J2.....A3
 J3.....A3
- TRANSISTORS
 TR101.....C3
 TR102.....B4
 TR103.....B4
 TR301.....A4
 TR302.....A4
 TR303.....B3, 4
 TR304.....B3
 TR401.....E5
 TR402.....E5
 TR405.....D5
 TR406.....D5
 TR501.....D3
 TR502.....B3

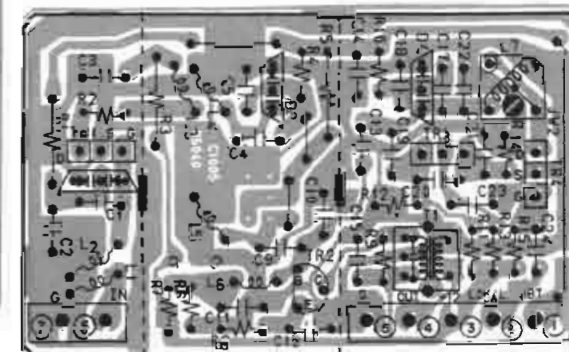

FRONT END

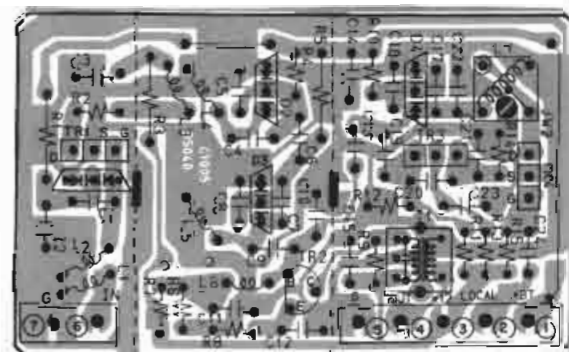

FRONT END PCB
 MODEL ONLY

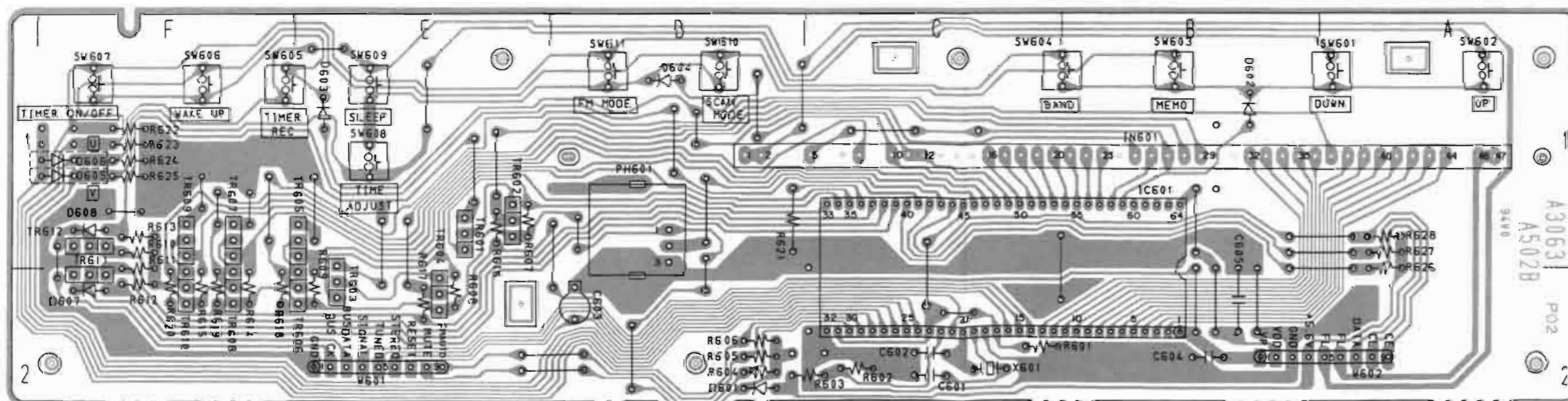

FRONT PCB A3063A502BJI

PRINCIPAL PARTS LOCATION

ICS
 IC101.....C4
 IC301.....A5

CONNECTORS
 J1.....F3
 J2.....A3
 J3.....A3

TRANSISTORS
 TR1.....F4
 TR2.....E4
 TR3.....E4
 TR4.....E4
 TR101.....C3
 TR102.....B4
 TR103.....B4
 TR201.....D4
 TR202.....D3
 TR203.....C4, 5
 TR301.....A4
 TR302.....A4
 TR304.....B4
 TR401.....E5
 TR402.....E5
 TR403.....D4
 TR404.....D4
 TR405.....D5
 TR406.....D5
 TR501.....D3
 TR502.....B3

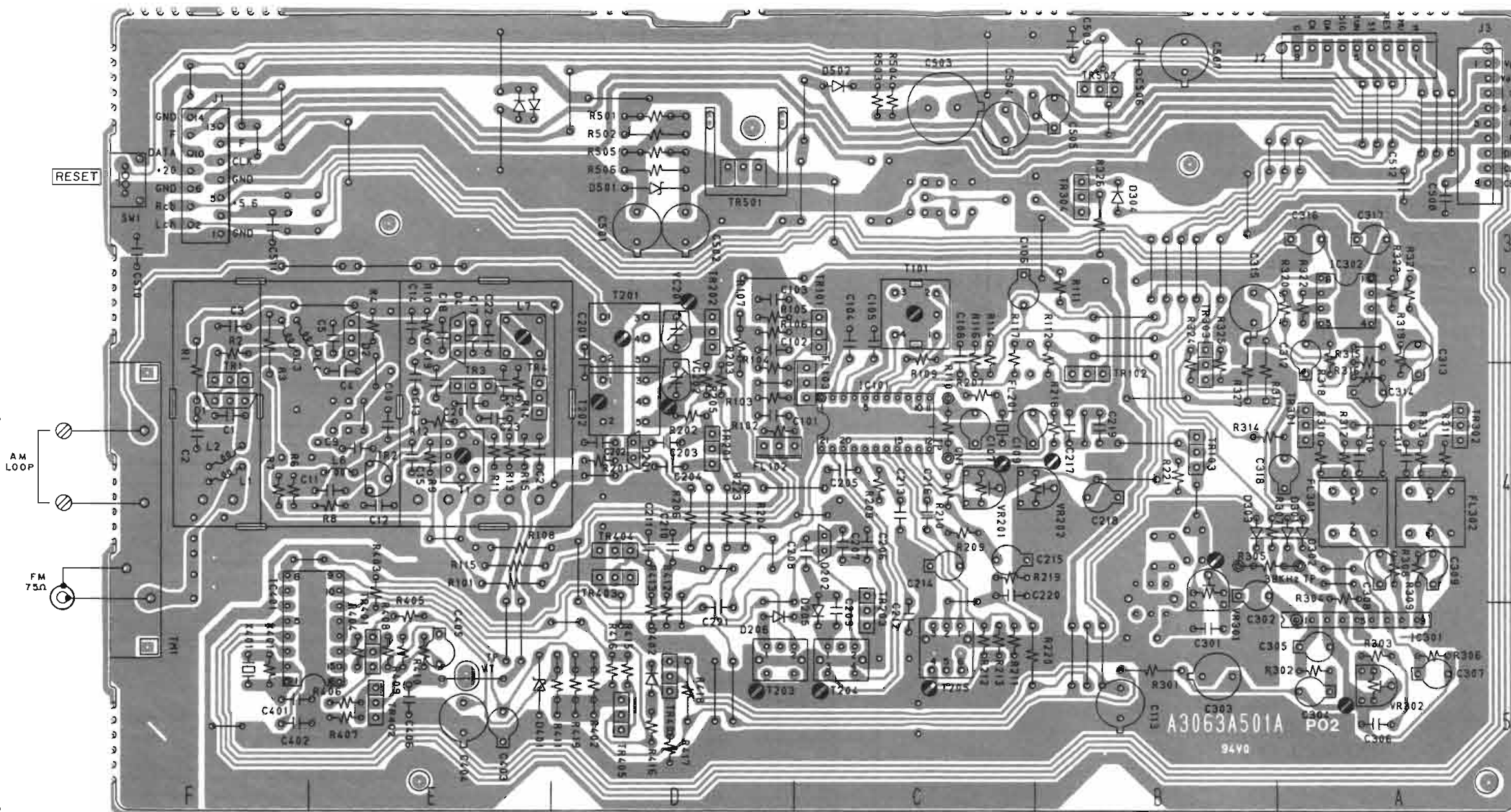

MAIN PCB A3063A501AJI [B] [E] Model

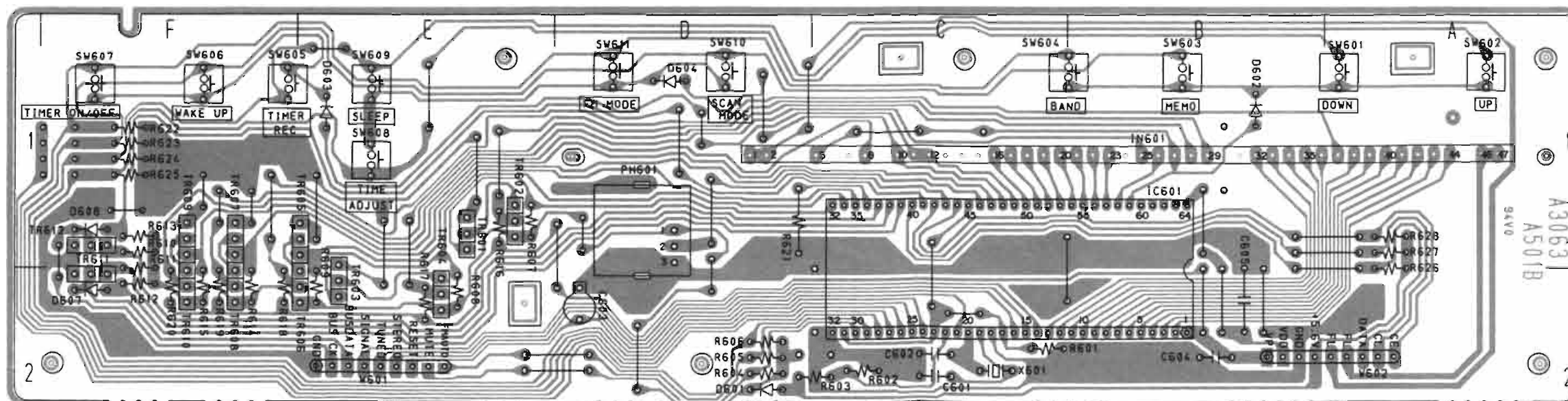

FRONT PCB A3063A501BJI [B] [E] Model

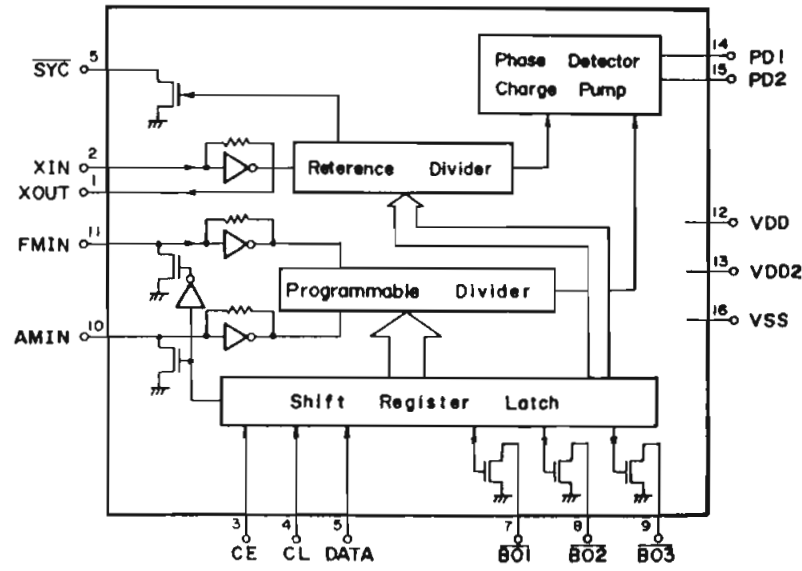
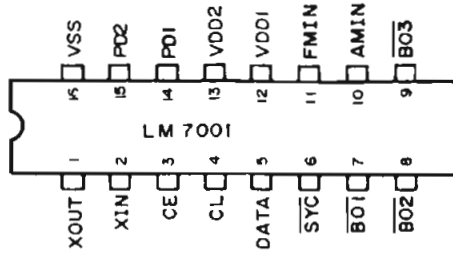

PIN NO.	PORT NAME	I/O	DESCRIPTION
1	VKK	I	Power input (-30 V)
2	S 1	O	Segment output Indicator.
3	S 2	O	
4	S 3	O	
5	S 4	O	
6	S 5	O	
7	S 6	O	
8	S 7	O	
9	S 8	O	
10	S 9	O	
11	S 10	O	
12	S 11	O	
13	S 12	O	
14	SIGNAL	I	Signal mode input.
15	TUNED	I	Tuned mode input. L: TUNED
16	STEREO	I	Stereo mode input. L: STEREO
17	K 03	-	Not used.
18	TEST	-	
19	X IN	I	Oscillator for clock.
20	X OUT	O	
21	RESET	I	Reset input.
22	HOLD	I	Power down detect.
23	P 00	-	Not used.
24	KEY 0	I	Key scan input from key matrix.
25	KEY 1	I	
26	KEY 2	I	
27	KEY 3	I	
28	VERSION	O	Output for Version Judge.
29	FM AUTO	O	FM Auto control. L: FM MANUAL H: FM AUTO
30	MUTE	O	Mute control. L: MUTE ON H: MUTE OFF
31	POWER	-	Not used.
32	VSS	-	GND
33	S 13	O	Segment output Indicator.
34	S 14	O	
35	S 15	O	
36	P23	-	Not used.
37	CK 0	O	Clock output.
38	DATA 0	O	Data output.
39	DATA 1	I	Data input.
40	DATA	O	Transfer data to PLL IC.
41	CK 1	I	Clock input.
42	CL	O	Clock output to PLL IC.
43	REMOCON	I	Remocon data input.
44	CE	O	Chip enable output for selecting PLL IC.
45	R 90	-	Not used.
46	3 G	O	Digit Data output for Indicator.
47	14 G	O	
48	13 G	O	
49	12 G	O	
50	11 G	O	
51	10 G	O	
52	9 G	O	
53	8 G	O	
54	7 G	O	
55	6 G	O	
56	5 G	O	
57	4 G	O	
58	2 G	O	
59	1 G	O	
60	Q 3	-	Not used.
61	Q 2	-	
62	Q 1	-	
63	Q D	-	
64	VDD	-	+B (+5 V)

PIN NO.	PORT NAME	I/O	DESCRIPTION
1	VKK	I	Power input (-30 V)
2	S 1	O	Segment output Indicator.
3	S 2	O	
4	S 3	O	
5	S 4	O	
6	S 5	O	
7	S 6	O	
8	S 7	O	
9	S 8	O	
10	S 9	O	
11	S 10	O	
12	S 11	O	
13	S 12	O	
14	K 00	-	Not used.
15	TUNED	I	Tuned mode input.
16	STEREO	I	Stereo mode input.
17	K 03	-	Not used.
18	TEST	-	Not used.
19	X IN	I	Oscillator for clock.
20	X OUT	O	Oscillator for clock.
21	RESET	I	Reset input.
22	HOLD	I	Power down detect.
23	P 00	-	Not used.
24	KEY 0	I	Key scan input from key matrix.
25	KEY 1	I	
26	KEY 2	I	
27	KEY 3	I	
28	VERSION	O	Output for Version Judge.
29	FM AUTO	O	L: FM MANUAL H: FM AUTO
30	MUTE	O	Mute control. L: MUTE ON H: MUTE OFF
31	P13	-	Not used.
32	VSS	-	GND
33	3 G	O	Digit Data output Indicator.
34	9 G	O	
35	P22	-	Not used.
36	P23	-	Not used.
37	CK 0	O	Clock output.
38	DATA OUT	O	Data output.
39	DATA IN	I	Data input.
40	DATA	O	Transfer data to PLL IC.
41	CLK I	I	Clock input.
42	CL	O	Clock output to PLL IC.
43	REMOCON	I	Remocon data input.
44	CE	O	Chip enable output for selecting PLL IC.
45	R 90	-	Not used.
46	R 91	-	
47	R 92	-	
48	R 30	-	
49	8 G	O	Digit Data output for Indicator and Key scanning.
50	7 G	O	
51	6 G	O	
52	5 G	O	
53	4 G	O	
54	2 G	O	
55	1 G	O	
56	S 16	O	Segment output for Indicator.
57	S 15	O	
58	S 14	O	
59	S 13	O	
60	G 3	-	Not used.
61	G 2	-	
62	G 1	-	
63	G D	-	
64	VDD	-	