



## STEREO TAPE DECK

MODEL **GX-260D**

SECTION 1	SERVICE MANUAL .....	3
SECTION 2	PARTS LIST .....	29
SECTION 3	SCHEMATIC DIAGRAM .....	55

---

SECTION 1

# SERVICE MANUAL

## TABLE OF CONTENTS

<b>I.</b>	<b>SPECIFICATIONS</b>	4
<b>II.</b>	<b>MEASURING METHOD</b>	5
	1. TAPE SPEED DEVIATION	5
	2. WOW AND FLUTTER	5
	3. FREQUENCY RESPONSE	5
	4. SIGNAL TO NOISE RATIO	5
	5. TOTAL HARMONIC DISTORTION	6
	6. CROSS TALK	6
	7. ERASE RATIO	6
<b>III.</b>	<b>DISMANTLING OF UNIT</b>	7
<b>IV.</b>	<b>MECHANISM ADJUSTMENTS</b>	10
	1. BRAKE TENSION ADJUSTMENT	10
	2. REEL HEIGHT ADJUSTMENT	10
	3. SUPPLY VOLTAGE TO BOTH TORQUE MOTORS AND TENSION AT EACH MODE	12
	4. ADJUSTMENT OF PINCH ROLLER MECHANISM	12
<b>V.</b>	<b>HEAD ADJUSTMENTS</b>	13
	1. HEAD HEIGHT ADJUSTMENT	13
	2. HEAD AZIMUTH ALIGNMENT ADJUSTMENT	14
<b>VI.</b>	<b>AMPLIFIER ADJUSTMENTS</b>	15
	1. PLAYBACK LEVEL ADJUSTMENT	15
	2. VU METER SENSITIVITY ADJUSTMENT	15
	3. RECORDING LEVEL ADJUSTMENT	16
	4. RECORDING BIAS FREQUENCY MEASURING METHOD AND ADJUSTMENT	16
	5. FREQUENCY RESPONSE ADJUSTMENT	17
	6. ERASE VOLTAGE	17
<b>VII.</b>	<b>MECHANICAL OPERATING PRINCIPLES</b>	18
	1. DIRECTION CHANGE OF MAIN MOTOR REVOLUTIONS	18
	2. TORQUE MOTOR SUPPLY VOLTAGE	18
	3. FORWARD MODE	18
	4. REV MODE	18
	5. FAST FORWARD MODE	18
	6. RWD MODE	18
	7. STOP MODE	18
<b>VIII.</b>	<b>COMPOSITE VIEWS OF COMPONENTS</b>	23

# I. SPECIFICATIONS

An asterisk next to a figure indicates the minimum guaranteed performance.

TRACK SYSTEM	4-track 2-channel stereo/monaural system	
REEL CAPACITY	Up to 7" reel	
TAPE SPEED	7-1/2 ips (19 cm/sec.) $\pm 0.8\%$ 3-3/4 ips (9.5 cm/sec.) $\pm 1\%$	
WOW AND FLUTTER	Less than 0.06% (*0.12%) RMS at 7-1/2 ips Less than 0.1% (*0.2%) RMS at 3-3/4 ips	
FREQUENCY RESPONSE	Low Noise Tape	30 to 26,000 Hz (*30 to 23,000 Hz) $\pm 3$ dB at 7-1/2 ips 30 to 20,000 Hz (*40 to 17,000 Hz) $\pm 3$ dB at 3-3/4 ips
	Normal Tape	30 to 23,000 Hz (*30 to 22,000 Hz) $\pm 3$ dB at 7-1/2 ips 30 to 18,000 Hz (*40 to 16,000 Hz) $\pm 3$ dB at 3-3/4 ips
DISTORTION	Less than 1.2% (*2%) at 7-1/2 ips (1,000 Hz O VU) Less than 3% at 3-3/4 ips (1,000 Hz O VU)	
SIGNAL TO NOISE RATIO	Better than 57 dB (*50 dB) (Tape selector circuit activated) Better than 54 dB (Tape selector circuit inactivated)	
CROSS TALK	Better than 60 dB (*55 dB) monaural Better than 45 dB (*40 dB) stereo	
BIAS FREQUENCY	100 kHz $\pm 5\%$	
ERASE RATIO	Better than 65 dB	
BIAS LEAK	Less than -30 VU	
HIGH FREQUENCY DEVIATION		
	Between Channels	Within 3 dB, using a 8,000 Hz 3-3/4 ips recorded tape at 7-1/2 ips
	Between FWD/REV	Within 3.5 dB, using a 8,000 Hz 3-3/4 ips recorded tape at 7-1/2 ips
INPUTS	Mic Input	0.3 mV Impedance: 10 k $\Omega$
	Line Input	60 mV Impedance: 150 k $\Omega$
	Din Input	3 mV (Low) Impedance: 24 k $\Omega$ 60 mV (High) Impedance: 22 k $\Omega$
OUTPUTS	Line Output	1.23V (+4 dB) Impedance: 100 $\Omega$ (Required load impedance more than 20 k $\Omega$ )
	Din Output	0.614V
RECORDING CAPACITY	60 min. stereo recording, using 1,200 ft tape at 7-1/2 ips	
F. FWD AND RWD TIME	About 82 sec. (50 Hz) About 66 sec. (60 Hz), using a 1,200 ft tape	
MOTORS	Capstan Motor	4/8-pole self-lubricating hysteresis synchronous 2-speed motor Type: HM2-16ND (Winterized) Condenser Capacity: 1 $\mu$ F 50 Hz 2 $\mu$ F 60 Hz (GX-260D UL) Revolutions: 1,500/750 r.p.m. at 50 Hz 1,800/900 r.p.m. at 60 Hz
	Reel Motor	Two 6-pole eddy current outer rotor motors Type: 24XO-MR Revolutions: 930 r.p.m. at 50 Hz 1,120 r.p.m. at 60 Hz
HEADS	Comb. Rec/Erase Head	Type: RE4-5 Gap: 3.5 to 5.5 $\mu$ Impedance: REC. HEAD 1,400 $\Omega$ $\pm 25\%$ at 100 kHz ERASE HEAD 130 $\Omega$ $\pm 7\%$ at 100 kHz D.C. Resistance: REC. HEAD 5.5 $\Omega$ ERASE HEAD 1.8 $\Omega$
	Playback Head	Type: P4-202 Gap: 1.7 $\mu$ $\pm 0.5\mu$ Impedance: 1.4 k $\Omega$ at 1 kC D.C. Resistance: 268 $\Omega$
TRANSISTORS	2SC1312(G) (H) ... 10 2SC711(D) (E) ... 14 2SC711(E) (F) ... 5 2SC1013(D) (E) ... 1	
DIODES	WG599 ... 6 10D05 ... 4 1N34A ... 3 10D6 ... 3 10D1 ... 1 WZ240 ... 1 10D4 ... 2	
POWER SUPPLY	100 to 240VAC 50/60 Hz	
POWER CONSUMPTION	110W max.	
DIMENSIONS	446(W) x 473(H) x 226(D) mm (17.5" x 18.6" x 8.9")	
WEIGHT	20.8 kg (45.8 lbs.)	

NOTE: Specifications subject to change without notice.

## II. MEASURING METHOD

### 1. TAPE SPEED DEVIATION



Fig. 1

As shown in Fig. 1, connect a Frequency Counter to the Line Output of Model GX-260D. Playback a 1,000 Hz pre-recorded test tape. Take a Frequency Counter reading at the beginning, middle, and end of tape winding during playback. The maximum value of these respective readings will represent tape speed deviation.

### 2. WOW AND FLUTTER

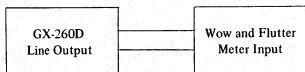

Fig. 2

#### METHOD A

As shown in Fig. 2, connect the Line Output of Model GX-260D to the Input of a Wow and Flutter Meter. Playback a 3,000 Hz pre-recorded test tape and take a Wow and Flutter Meter reading at the beginning, middle, and end of tape winding. The maximum value of these respective readings will represent the Wow and Flutter.

#### METHOD B

Supply a 3,000 Hz sine wave signal from an Audio Frequency Oscillator and make a recording on a blank tape at the beginning, middle, and end of tape winding. Rewind and playback the resultant signal. Measure Wow and Flutter with a Wow and Flutter Meter. (The Wow and Flutter value of Method B will be close to  $\sqrt{2}$  times of value of Method A.)

### 3. FREQUENCY RESPONSE

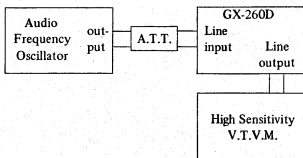

Fig. 3

For measuring Frequency Response, connect instruments as shown in Fig. 3 and proceed as follows:

- 1) Supply a 1,000 Hz sine wave signal to the Line Input of Model GX-260D from an Audio Frequency Oscillator through an Attenuator.
- 2) Set recorder to recording mode and turn recording level control volume to maximum. Adjust attenuator to obtain a +4 dB V.T.V.M. reading.
- 3) Under conditions described in 2) above, readjust attenuator so that the Line Output is -16 dB, and record 30 to 24,000 Hz spot frequencies.
- 4) Rewind tape and playback from the beginning. Take V.T.V.M. spot frequency readings and plot values on a graph.

NOTE: When measuring Frequency Response, new tape should be used.

### 4. SIGNAL TO NOISE RATIO



Fig. 4

As shown in Fig. 4, connect a High Sensitivity V.T.V.M. to the Line Output of Model GX-260D. Playback a 250 Hz "O" VU pre-recorded test tape and measure the output. Then remove the tape and measure the noise level under the same condition. Convert each of the measured values into decibels.

## 5. TOTAL HARMONIC DISTORTION

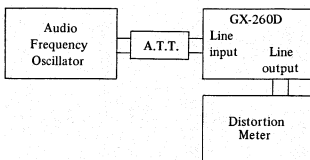

Fig. 5

Connect the measuring instruments as shown in Fig. 5 and record a 1,000 Hz sine wave signal at "0" VU. Playback the resultant signal and measure the overall distortion factor.

NOTE 1) At this time, Distortion of the Audio Frequency Oscillator must be sufficiently small.

2) When measuring the distortion factor, new tape should be used.

## 6. CROSS TALK (Cross talk between the tracks)

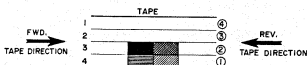

Fig. 6

As shown in Fig. 6, first record a 1,000 Hz sine-wave signal on track No. 3 at +3 VU level.

Next, record under a non-input condition. Then playback the tape on track No. 3 and (1) (reversed condition of tape) through the B.P.F. (1,000 Hz Band Pass Filter, sensitivity 1,000 Hz, ratio 1:1) and obtain the ratio from the following formula.

$$C = 20 \log \frac{E_0}{E_2 - E_1} \text{ (dB)}$$

where, C = Desired cross talk ratio (dB)

$E_0$  = 1,000 Hz signal output level (V)

$E_2$  = 1,000 Hz cross talk level (V)

$E_1$  = Non-input cross talk level (V)

## 7. ERASE RATIO

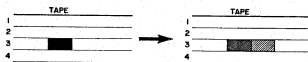

Fig. 7

As shown in Fig. 7, using a virgin tape, first record a 1,000 Hz sine wave signal at +3 VU level, then playback this recorded signal and take a V.T.V.M. reading at the output level.

Next, erase this recorded portion and playback the erased part through the B.P.F. (1,000 Hz sensitivity 1:1) and take readings of the erased signal. Obtain a ratio between the two from the following formula:

$$Er = 20 \log \frac{E_0}{E_2 - E_1} \text{ (dB)}$$

where, Er = Desired erase ratio

$E_0$  = 1,000 Hz signal output level (V)

$E_2$  = Erased 1,000 Hz signal and noise level (V)

$E_1$  = Erased noise level (V)

NOTE: When measuring cross talk and erase ratio virgin tape should be used.

### III. DISMANTLING OF UNIT

---

In case of trouble, etc. necessitating disassembly, please disassemble in the order shown in photographs. Re-assemble in reverse order.

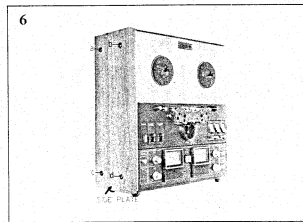
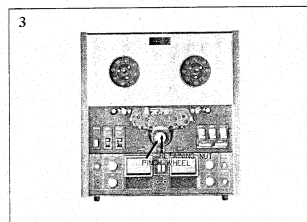
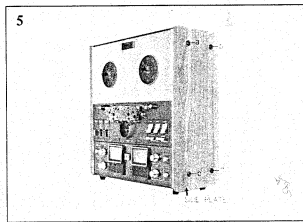
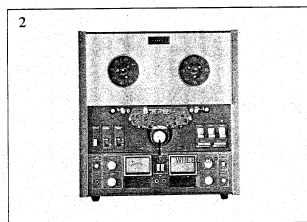
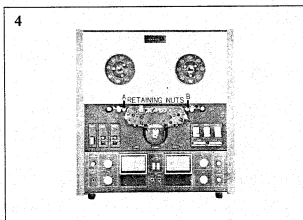
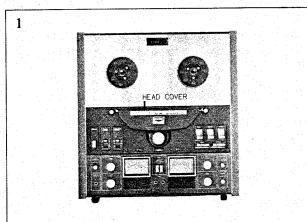

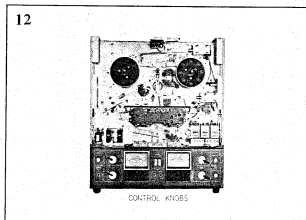
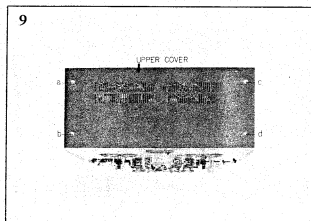
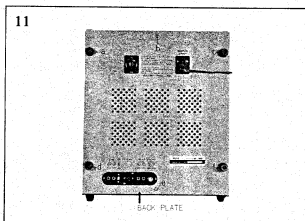
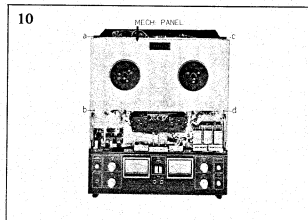
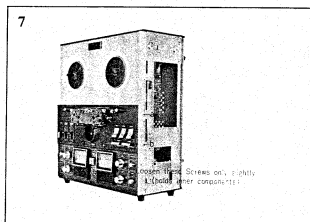

13

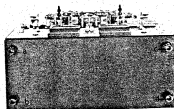

LOWER COVER

17

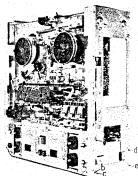

SCREWS

14

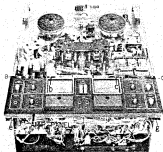

18

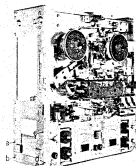

SCREWS

15



AMPLIFIER &amp; MECHANISM ADJUSTMENT

19

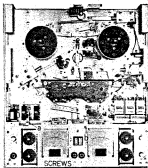

SCREWS

16

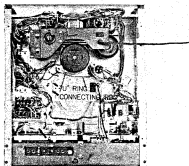

CONNECTION PLUGS

20

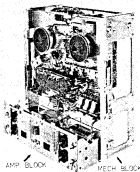

AMP BLOCK MECH BLOCK



## IV. MECHANISM ADJUSTMENTS

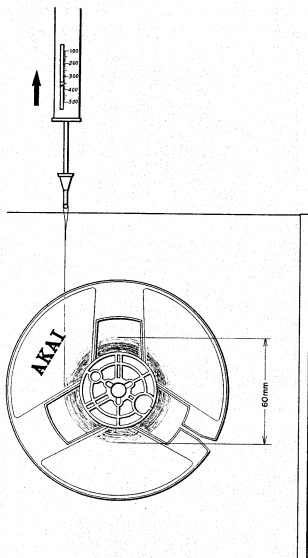

Fig. 8

### 1. BRAKE TENSION ADJUSTMENT

Use a 60 mm diameter tape wound on a 5" reel and measure the brake tension with a tension gauge. (See Fig. 8) Ideal tape tension is 380 grams.

Brake Tension Adjustment can be made as follows:

- 1) Adjust position of suspended springs (d) (d').
- 2) Loosen screws (a) (b) and (a') (b'), and adjust the vertical (upper/lower) position of spring suspension metal (c) (c').
- 3) Loosen screws (e) (f) and (e') (f'), and adjust the horizontal (left/right) position of brake band suspension metal (g) (g').

Adjust as described above until proper brake tension is attained (Refer to Fig. 9).

**NOTE:** In making Brake Tension Adjustment, when the machine is set to other than stop mode, confirm that the brake band definitely does not touch the cloth tape on the brake drum. (See Fig. 10)

### 2. REEL HEIGHT ADJUSTMENT

Loosen the reel table height adjustment screws own in Fig. 11 and adjust by moving the reel ble in the direction of arrow and positioning so at the tape winds in the center of the reel.

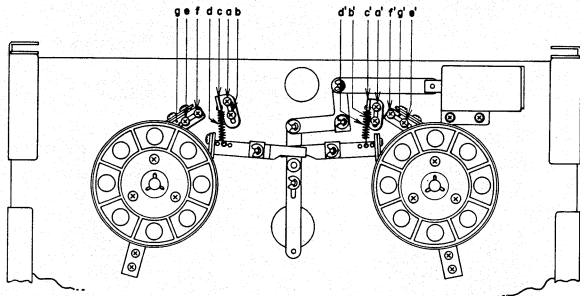

Fig. 9

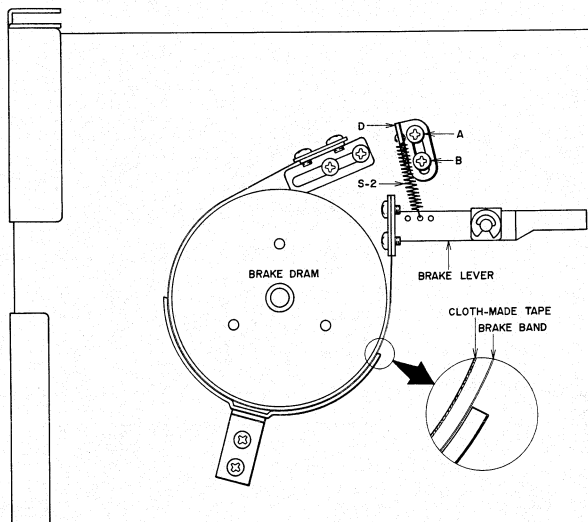

Fig. 10

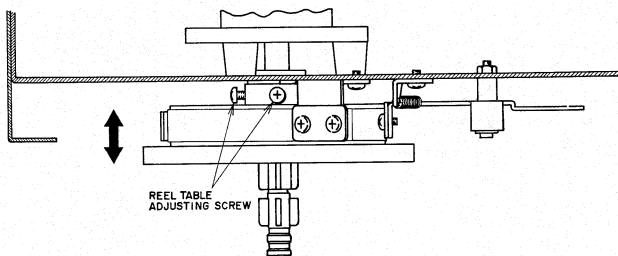

Fig. 11

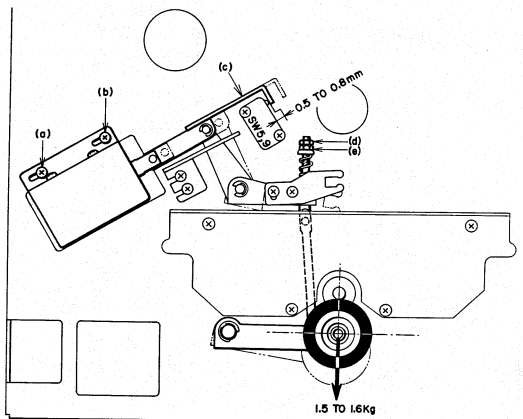

Fig. 12

### 3. SUPPLY VOLTAGE TO BOTH TORQUE MOTORS AND TENSION AT EACH MODE

(Values indicated are during operating mode)

Torque	Left Side	Right Side
FWD	45V	66V
	45g	100g
REV	66V	45V
	100g	45g
F. FWD	30V	115V
	25g	490g
REW	115V	30V
	490g	25g

Chart 1

### 4. ADJUSTMENT OF PINCH ROLLER MECHANISM

#### 1) Pinch Roller Solenoid Position

At playback mode, adjust the position of the pinch roller plunger so that the space between lever (c) and the Micro Switch is about 0.5 to 0.8 mm. Then tighten screws (a) (b) to maintain this position. (See Fig. 12)

#### 2) Pinch Wheel Pressure Adjustment

At playback mode, use a tension gauge and adjust nuts (d) (e) so that the pinch wheel pressure is from 1.5 to 1.6 kg.

## V. HEAD ADJUSTMENTS

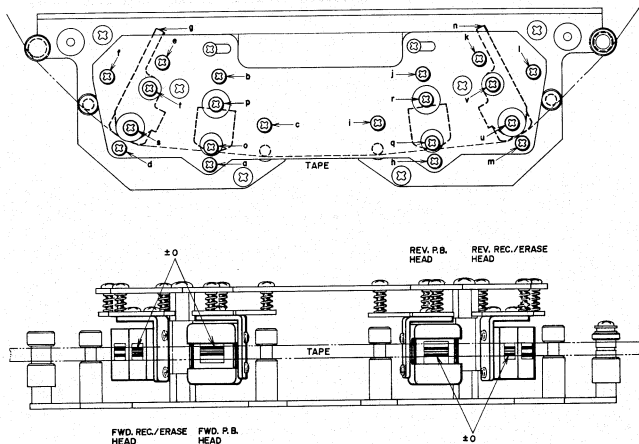

Fig. 13

### 1. HEAD HEIGHT ADJUSTMENT

#### 1) Playback Head (See Fig. 13)

a) At forward playback mode, adjust the height of the Fwd playback head by turning screws a, b shown in Fig. 13 until the upper edge of the tape and the lower edge of the left channel head core of the playback head are the same height.

b) At reverse playback mode, adjust the height of the Rev playback head by turning screws h, j shown in Fig. 13 until the lower edge of the tape and the lower edge of the right channel head core of the playback head are the same height.

#### 2) Recording and Erase Head

a) At forward playback mode, adjust the height of the recording head by turning screws d, e shown in Fig. 13 until the upper edge of the tape and the upper edge of the left channel head core of the recording head is the same height.

In this instance, because in combining the erase and recording head, slight unevenness exists, confirm that the upper edge of the erase head part is about 0.015 mm to 0.125 mm higher than the upper edge of the tape.

b) At reverse playback mode, adjust the height of the Rev recording head by turning screws k, m shown in Fig. 13 until the lower edge of the tape and the lower edge of the right channel head core of the recording head are the same height.

In the same way as for the forward and erase head, also confirm that the lower edge of the reverse and erase head part is about 0.115 mm to 0.125 mm lower than the lower edge of the tape.

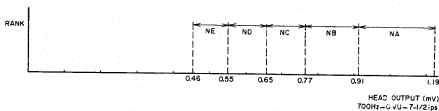

Chart 2



Fig. 14

## 2. HEAD AZIMUTH ALIGNMENT ADJUSTMENT

- 1) Forward Playback Head
  - a) Connect a high sensitivity V.T.V.M. to the output terminals.
  - b) Set the Tape Speed Switch to 7-1/2 ips, turn Line Output Level Controls to maximum, and set recorder to forward playback mode.
  - c) Playback an Alignment Test Tape (Ampex Alignment Test Tape 8,000 Hz, 3-3/4 ips recorded).
  - d) At forward playback mode, adjust Azimuth Alignment Adjustment screw C by turning to left and right until the line output level of both channels is maximum.
  - e) After the adjustment outlined in Item d) above has been completed, loosen screws o and p and move the gap side of the playback head to left and right, and position so that when tension is applied to the supply reel side, the line output level of both channels does not fluctuate. When a maximum allowable fluctuation of within  $+0.5/-0$  dB is attained, tighten screws o and p.
- 2) Reverse Playback Head
  - a) Follow "Forward Playback Head" procedure through Item c). Then, at reverse playback mode, adjust Azimuth Alignment Adjustment Screw i by turning to left and right until the line output level of both channels is maximum.
  - b) After the adjustment outlined in Item a) above has been completed, loosen screws q, r and move the gap side of the playback head to left and right, and position so that when tension is applied to the supply reel side, the line output level of both channels does not fluctuate. When a maximum allowable fluctuation of within  $+0.5/-0$  dB is attained, tighten screws q, r.
- 3) Forward Recording/Erase Head
  - a) Connect an Audio Frequency Oscillator to the line inputs and an high sensitivity V.T.V.M. to the line outputs, and load a blank tape.
  - b) Set the Monitor Selector Switch to TAPE position, and record a 16 kHz signal at  $-10$  dB level at forward recording mode.

- c) At forward recording mode, adjust Azimuth Alignment Adjustment Screw f by turning to left and right until the output level of both channels is maximum and does not fluctuate.
- d) After the adjustments outlined above have been completed, loosen Fwd recording head mounting screws s, t and move lever g to left and right and adjust the gap side of the recording head so that when tension is applied to the supply reel side, the line output level of both channels does not fluctuate. When a maximum allowable fluctuation of within  $+0.5/-0$  dB is attained, tighten screws s, t.

### 4) Reverse Recording/Erase Head

- a) In the same way as the forward recording, record at reverse recording mode.
- b) At reverse recording mode, adjust Azimuth Alignment Adjustment Screw l by turning to left and right until the output level of both channels is maximum and does not fluctuate.
- c) After the adjustments outlined above have been completed, loosen reverse recording head mounting screws u, v and move lever n (refer to Fig. 13) to left and right and adjust the gap side of the recording head so that when tension is applied to the supply reel side, the line output of both channels does not fluctuate. When a maximum allowable fluctuation of which  $+0.5/-0$  dB is attained, tighten screws u, v.

3. For best results, head demagnetizing should be performed before adjustments. All adjustments outlined in sections 1 and 2 should be repeated two or three times. Blank tape used in adjustments should be new tape.

### NOTE

- 1) In order to keep the difference in playback level between normal and reverse playback as small as possible, the FWD/Playback and the Rev/Playback Heads are categorized and marked "NA" to "NE" respectively. (See Fig. 14 and Chart 2)
- 2) When a playback Head is replaced, it is imperative that the same rank head be installed as was previously used.

In case the previously installed head rank is not available, both heads can be replaced with other heads of the same marks.

## VI. AMPLIFIER ADJUSTMENTS

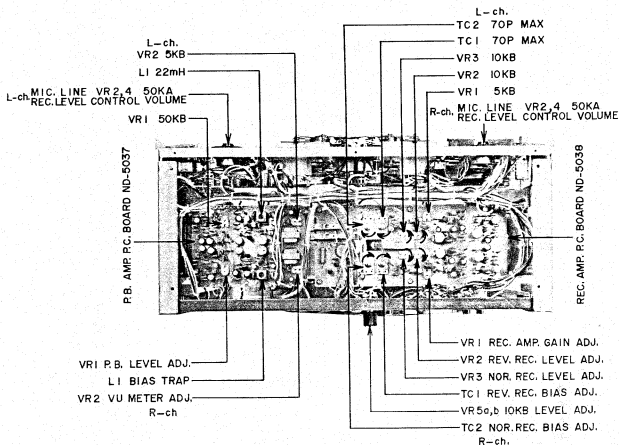

Fig. 15

### 1. PLAYBACK LEVEL ADJUSTMENT

(See Fig. 15)

- 1) Connect a High Sensitivity V.T.V.M. to the Line Output.
- 2) Set Tape Speed Selector to 7-1/2 ips.
- 3) Set Monitor Switch to TAPE position and Line Output Level Control VR5a, 5b to maximum.
- 4) Playback a 250 Hz, 7-1/2 ips pre-recorded tape.
- 5) With P.B. Amp. P.C. Board (ND-5037) semi-fixed resistor VR1 (50 k $\Omega$ ), set Line Output level of both channels to 4 dB  $\pm$ 1 dB at FWD and 4 dB  $\pm$ 1.5 dB at REV.

### 2. VU METER SENSITIVITY ADJUSTMENT

(See Fig. 15)

After Playback Adjustment is completed and an indication of +4 dB is attained, adjust P.B. Amp. P.C. Board (ND-5037) semi-fixed resistor VR2 (5 k $\Omega$ ) to obtain a VU meter indication of "0" VU on both channels.

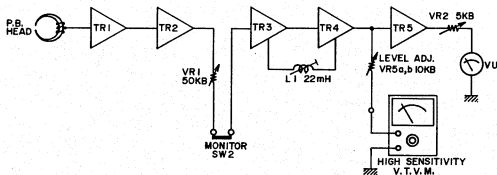

Fig. 16 P.B. AMP. BLOCK DIAGRAM

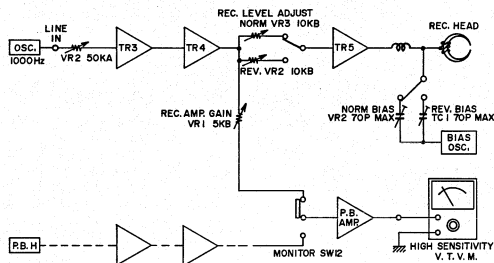

Fig. 17 REC. AMP. BLOCK DIAGRAM

### 3. RECORDING LEVEL ADJUSTMENT

(See Fig. 15)

- 1) Connect an Audio Frequency Oscillator to the line input and connect a High Sensitivity V.T.V.M. to the line output.
- 2) Set Tape Speed Selector to 7-1/2 ips.
- 3) Load a Scotch 111 blank tape and set the Monitor Switch to TAPE position.
- 4) Set recorder to recording mode, while depressing both LEFT and RIGHT Recording Track Selector Switches, and supply a 1,000 Hz sinewave signal to the line input from the audio frequency oscillator.
- 5) Adjust Forward and Reverse Recording Capacitors TC1 and TC2 to obtain maximum output on all channels.
  - \* In case of Frequency Response Bias adjustment having been made prior to Recording Level Adjustment, do not adjust these capacitors.
- 6) At this time, with forward and reverse recording level adjustment volumes VR2 and VR3, adjust each channel to 1 dB lower than the channel discharging the smallest output.
- 7) Adjust Audio Frequency Oscillator output to obtain a line output level of 4 dB (0 VU).

- 8) Set Monitor Switch to SOURCE position and adjust Rec. Amp. P.C. Board (ND-5038) Rec. Amp. Gain Adjustment Volumes VR1 (5 KB) to obtain a 4 dB Line Output level on each channel.

#### NOTE

- 1) Because the recording level is very closely related to the Frequency Response Adjustment (Section 5), re-confirm recording levels following frequency response adjustment.
- 2) For 0 VU recording, it is necessary that the microphone input level be about -70 dB following Rec. Level Adjustment.

### 4. RECORDING BIAS FREQUENCY MEASURING METHOD AND ADJUSTMENT

- 1) Connect a Frequency Counter to OSC Circuit. Set recorder to the REC mode, and take a frequency counter reading at this time.
- 2) If the Frequency Counter indication is  $100 \pm 5$  kHz, the recording bias frequency is correct.

#### Adjustment

The recording bias frequency can be adjusted by changing the value of OSC Circuit Condenser C27 (2,000P/250).

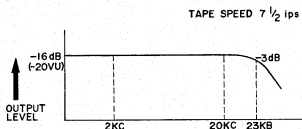

Fig. 18

## 5. FREQUENCY RESPONSE ADJUSTMENT

- j) Refer to section regarding Frequency Response Measuring Method (Fig. 3 of this manual).
- 2) Adjust REC Amp. P.C. Board semi-fixed capacitors TC1, TC2 (70P) so that a 20 kHz signal output level is the same in relation to 2,000 Hz. (See Fig. 18)
- 3) The Bias Voltage will vary depending on the Recording Head and tape being used.

### NOTE

- 1) The frequency response will vary depending upon the tape being used. For model GX-260D, Fuji tape F-100 is used for frequency response adjustment.
- 2) Prior to adjustment, record at non-signal input and adjust Bias Trap L1 (22 mH) so that the bias leak at line out is minimum. (See Fig. 15)

## 6. ERASE VOLTAGE

There is no way to adjust the Erase Voltage, but correct value is about 35V at 7-1/2 ips, and 30V 3-3/4 ips.



## VII. MECHANICAL OPERATING PRINCIPLES

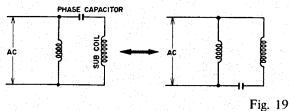

Fig. 19

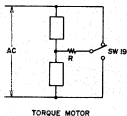

Fig. 20

Refer to Schematic Diagram 1460813

### 1. DIRECTION CHANGE OF MAIN MOTOR REVOLUTIONS

By means of manual operation or sensing tape, SW14, SW16 or sensing pole grounds the base of TR1 or TR2 on the system control board, thus facilitating or obstructing the lead through between E.C of TR2 and changing Rev Relay contact point RL1-3 as well as RL1-4 accordingly. This changes the position of the main motor sub coil and phase capacitor, and direction of the main motor revolutions is reversed. (See Fig. 19). At this time, when TR2 is turned on (Rev mode), the forward direction voltage of Diode D2 1N34A is decreased, and this low voltage is utilized to lower the base voltage of TR1, and TR1 is turned off. Thus, TR2 is held at ON condition for operating function.

### 2. TORQUE MOTOR SUPPLY VOLTAGE

Voltage is distributed by R3, SW 390Ω (at Fwd, Rev) and R2, 10W, 45Ω (at F.Fwd, Rwd) inserted parallel with the supply side of the left and right torque motors which are connected in series. (See Fig. 20)

### 3. FORWARD MODE

When the Fwd Button is depressed, this depresses SW14, SW13.

SW14 turns OFF TR2 from Rev mode, Reverse Relay RL1 is turned OFF, and the direction of main motor revolutions as well as the voltage distribution to the torque motor is changed.

When SW13 is depressed, AC 120V flows, to D8, and then DC170 flows to SW13→SW2→PL2→SW12→SW3, Plunger PL2 is pulled, and SW2, SW4 and SW6 are activated.

When SW2 is turned ON, AC 25V flows to D6→D7, and then DC30.5V flows to SW2→PL2→SW12→SW3, and PL2 is held by DC30.5V.

When SW4 is turned ON, AC120V flows to D8, and then DC170V flows to SW5→SW18→SW4→PL3→SW12→SW3, Plunger PL3 is pulled, and SW5 is activated.

When SW5 is activated, AC 25V flows to D6→D7, and then DC30.5V flows to SW5→SW18→SW4→PL3→SW12→SW3, and Plunger PL3 is held by DC30.5V.

When SW6 is activated, AC120V is supplied to the Torque Motors, quick tension SW8 connected to the Pinch Wheel Lever works after a slight delay, and AC100V passes resistors R1, R4 and is supplied to the torque motors.

The purpose of the quick Tension Switch is to prevent the tape transported from the capstan from running roughly and unevenly, when the torque motor is suddenly started from stopped condition. The Quick Tension Switch works from Stop to Fwd or Rev, but does not work to and from Fwd and Rev.

### 4. REV. MODE

When the Rev Button is depressed, SW16, SW15 are activated.

SW16 turns OFF TR1 from Fwd mode, TR2 is turned ON, RL1 is activated, and the direction of the main motor as well as the voltage distribution to the torque motor is changed.

When RL1 is turned ON, contact point RL1-2 is closed, AC120V flows to D8, and then DC170V flows to SW1→RL1-2→PL1→SW3, and PL1 works. When PL1 is activated, AC25V flows to D6→D7, and then DC29.5V flows to SW1→RL1-2→PL1→SW3, and PL1 is held at ON condition.

The voltage applied to PL2, PL3 as well as the torque motor, and the function of the Quick Tension Switch etc. are the same as at Fwd mode.

### 5. FAST FORWARD MODE

When the OFF Button is depressed, SW13, SW18, SW19, SW17 are activated.

When SW13 is depressed, Brake Plunger PL2 works in the same way as at Fwd mode, SW18 functions to prevent Pinch Wheel Plunger PL3 from working. SW19 changes the voltage distribution to the torque motor.

SW17 is mechanically held. The resistor inserted parallel with the torque motor is changed to R2 10W 45Ω by SW17.

### 6. RWD MODE

When the Rewind Button is depressed, SW15, SW18, SW19, SW17 are activated.

The function of these various switches are the same as at Forward & at Forward mode.

### 7. STOP MODE

At each mode the brakings work when the SW12 which is interlocked with the Stop Button is released, and PL2, PL3 and the respective switches interlocked with these plungers are released.





GX-2600

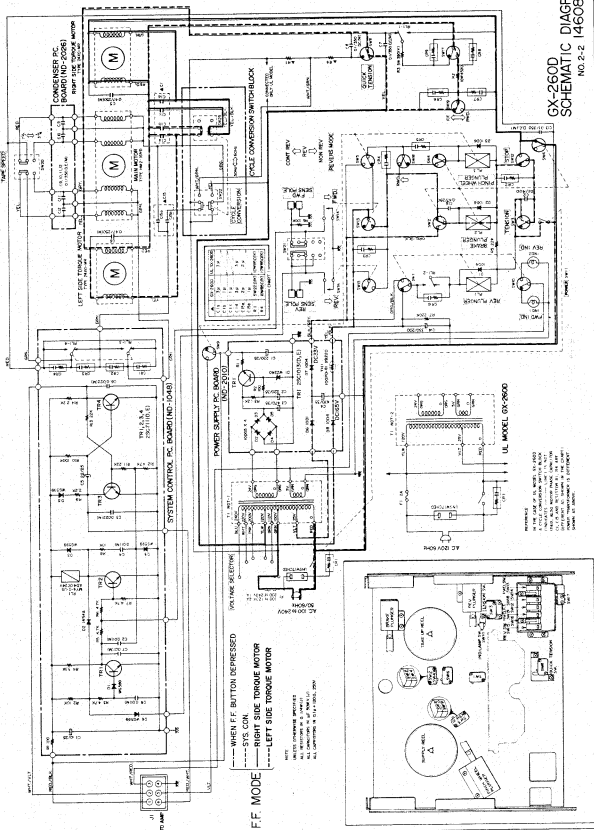

SCHEMATIC-3

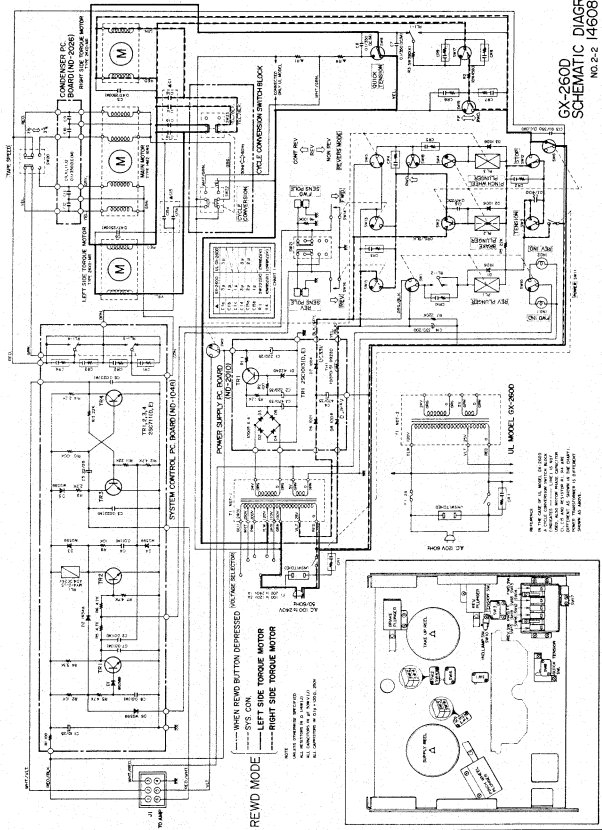

GX-2600  
SCHEMATIC DIAGRAM  
NO. 2-2 1460813A

# VIII. COMPOSITE VIEWS OF COMPONENTS

## 1. REC. AMP. P.C. BOARD ND-5038

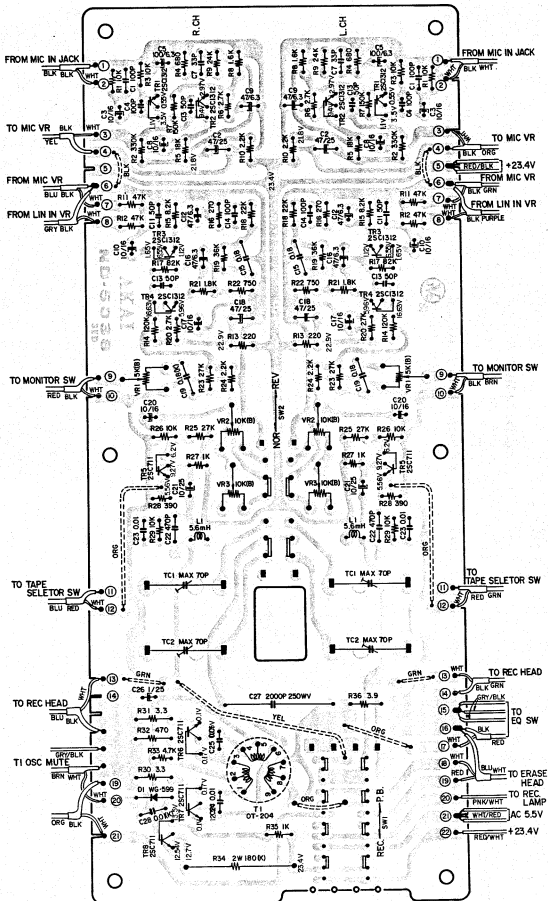

2. P.B. AMP. P.C. BOARD ND-5037

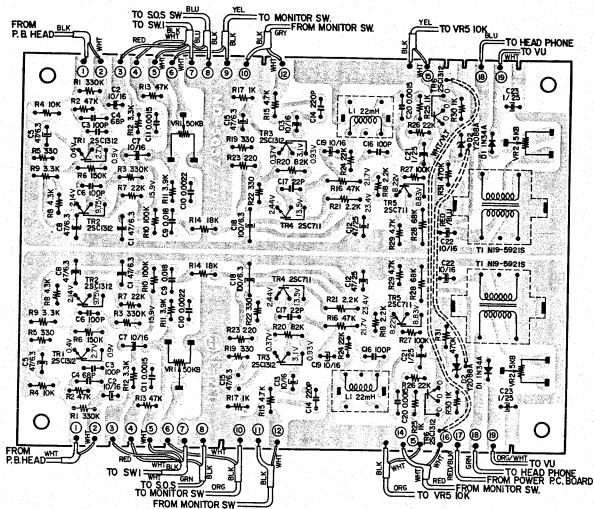

3. EQUALIZER SW. P.C. BOARD ND-5042

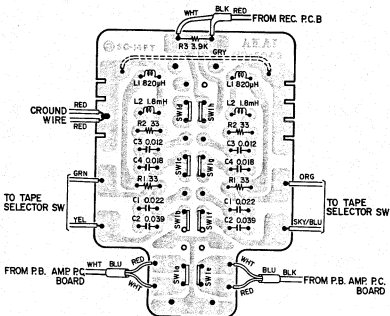

#### 4. HEAD CHANGE SW. P.C. BOARD ND-0025

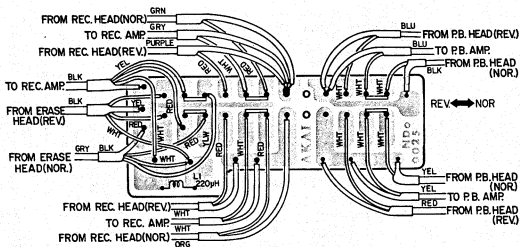

#### 5. SYS. CON. P.C. BOARD ND-1048

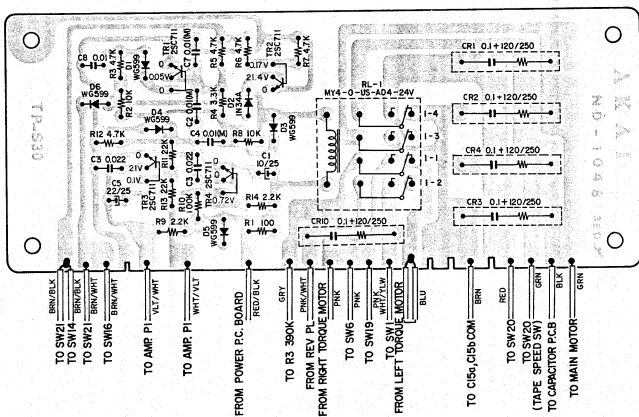



## 6. POWER SUPPLY P.C. BOARD ND-2010

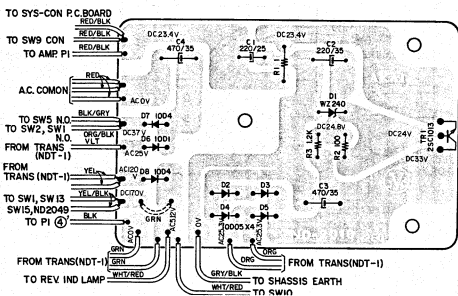

## 7. CONDENSER P.C. BOARD ND-2026

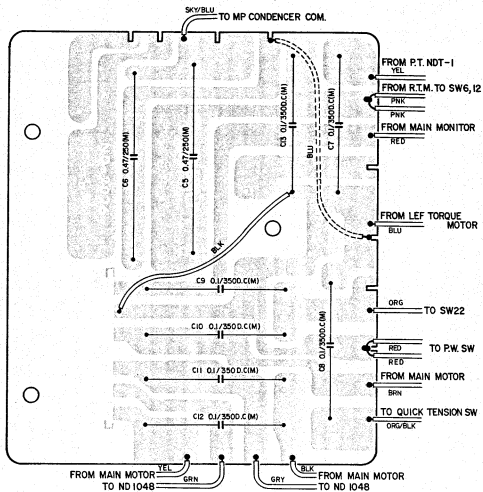

## 8. SPARK QUENCHER P.C. BOARD ND-2049

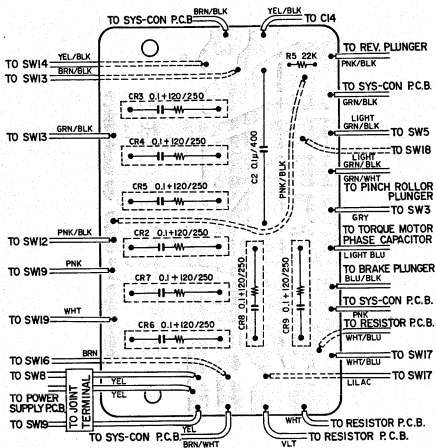

## 9. RESISTOR P.C. BOARD ND-2013

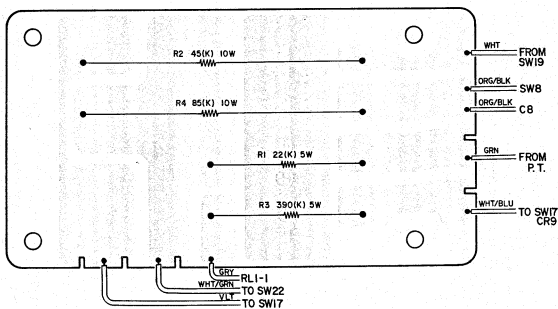

10. NOR. LAMP P.C. BOARD ND-1051

11. REV. LAMP P.C. BOARD ND-1051

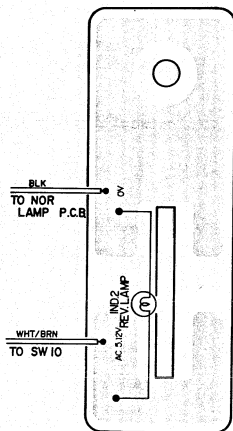
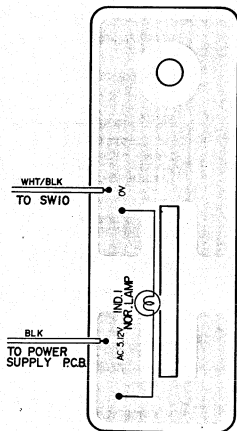

---

**SECTION 2**  
**PARTS LIST**

**TABLE OF CONTENTS**

<b>FIG. 1</b>	<b>ND HEAD BLOCK</b> .....	<b>33</b>
<b>FIG. 2</b>	<b>MAIN MOTOR BLOCK</b> .....	<b>34</b>
<b>FIG. 3</b>	<b>REEL MOTOR/REEL TABLE BLOCK</b> .....	<b>35</b>
<b>FIG. 4</b>	<b>FLYWHEEL BLOCK</b> .....	<b>36</b>
<b>FIG. 5</b>	<b>OPERATION BLOCK</b> .....	<b>37</b>
<b>FIG. 6</b>	<b>SPEED SWITCH BLOCK</b> .....	<b>38</b>
<b>FIG. 7</b>	<b>POWER SUPPLY/REAR PLATE BLOCK</b> .....	<b>40</b>
<b>FIG. 8</b>	<b>MECHANISM ASSEMBLY BLOCK</b> .....	<b>41</b>
<b>FIG. 9</b>	<b>AMPLIFIER ASSEMBLY BLOCK</b> .....	<b>45</b>
<b>FIG. 10</b>	<b>SPARK QUENCHER P.C. BOARD (ND-2049) BLOCK</b> .....	<b>46</b>
<b>FIG. 11</b>	<b>CONDENSER P.C. BOARD (ND-2026) BLOCK</b> .....	<b>46</b>
<b>FIG. 12</b>	<b>POWER SUPPLY P.C. BOARD (ND-2010) BLOCK</b> .....	<b>47</b>
<b>FIG. 13</b>	<b>EQUALIZER SWITCH P.C. BOARD (ND-5042) BLOCK</b> .....	<b>47</b>
<b>FIG. 14</b>	<b>SYS. CON. P.C. BOARD (ND-1048) BLOCK</b> .....	<b>48</b>
<b>FIG. 15</b>	<b>REC. AMP. P.C. BOARD (ND-5038) BLOCK</b> .....	<b>49</b>
<b>FIG. 16</b>	<b>P.B. AMP. P.C. BOARD (ND-5037) BLOCK</b> .....	<b>50</b>
<b>FIG. 17</b>	<b>FINAL ASSEMBLY BLOCK</b> .....	<b>52</b>
<b>INDEX</b>	.....	<b>53</b>

## HOW TO USE THIS PARTS LIST

1. This parts list is compiled by various individual blocks based on assembly process.
2. When ordering parts, please describe parts number, serial number, and model number in detail.
3. How to read List

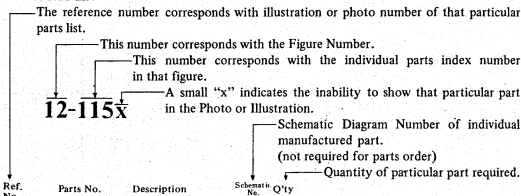

Ref. No.	Parts No.	Description	Schematic No.	Q'ty
<b>FLYWHEEL BLOCK #13</b>				
12-115x	800425	Flywheel Block Assy. Comp.	RDG #13	1
12-116	244506	Flywheel Only	RD-233	1
12-117x	244754	Felt, Flywheel	RD-275	1
12-118	251324	Main Metal Case	RD-236	1
12-119	253080	Main Metal	RD-237	1

4. The symbol numbers shown on the P.C. Board list can be matched with the Composite Views of Components of the Schematic Diagram or Service Manual.
5. The indications of Resistors and Capacitors in the photos of P.C. Board are being eliminated.
6. The shape of the parts and parts name, etc. can be confirmed by comparing them with the parts shown on the Electrical Parts Table of P.C. Board.
7. Both the kind of part and installation position can be determined by the Parts Number. To determine where a parts number is listed, utilize Parts Index at end of Parts List.  
It is necessary first of all to find the Parts Number. This can be accomplished by using the Reference Number listed at right of parts number in the Parts Index. (meaning of ref. no. outlined in Item 3 above).
8. Utilize separate "Price List for Parts" to determine unit price. The most simple method of finding parts Price is to utilize the reference number.

## ELECTRICAL PARTS TABLE

<p><b>ELECTRICAL PARTS TABLE</b>            Because the indication of resistors and capacitors in the P.C. Board photos are being eliminated, please confirm parts name and shape by comparing them with the parts shown in this table.</p>	<p>1</p>  <p>Solid Resistor</p>	<p>2</p> <p style="text-align: right;">Stopper Type</p>  <p>Insulator Type</p> <p>Carbon Resistor</p>	<p>3</p>  <p>Metal Oxide Film Resistor</p>	
	<p>4</p>  <p>Cement Resistor</p>	<p>5</p>  <p>Wire-Wound Resistor</p>	<p>6</p>  <p>Thermister</p>	<p>7</p>  <p>Enamel Resistor</p>
	<p>1</p>  <p>MP Capacitor (Tubular Type)</p>	<p>2</p>  <p>Plastic Capacitor</p>	<p>3</p>  <p>Mylar Capacitor</p>	<p>4</p>  <p>VFM (HI-Q) Capacitor</p>
<p>5</p>  <p>Mylar Capacitor</p>	<p>6</p>  <p>Tantalum Capacitor</p>	<p>7</p>  <p>Oil Capacitor (Tubular Type)</p>	<p>8</p> <p style="text-align: right;">Vertical Type</p>  <p>Tubular Type</p> <p>Styrol Capacitor</p>	
<p>9</p>  <p>Electrolytic Capacitor (Tubular Type)</p>	<p>10</p> <p style="text-align: right;">Vertical Type</p>  <p>Tubular Type</p> <p>Electrolytic Capacitor</p>	<p>11</p>  <p>Ceramic Capacitor</p>	<p>12</p>  <p>Metalized Mylar (Paper) Capacitor</p>	
<p>13</p>  <p>Trimmer Condenser</p>	<p>VR</p>  <p>Semi-Fixed Volume</p>			
<p>L</p>  <p>Ferri Inductor</p>	<p>TR</p>  <p>Transistor</p>			
<p>CR</p>  <p>Spark Quencher</p>	<p>D</p>  <p>Diode (Silicon, Zener, Germanium)</p>			

FIG. 1 ILLUSTRATION OF ND HEAD BLOCK

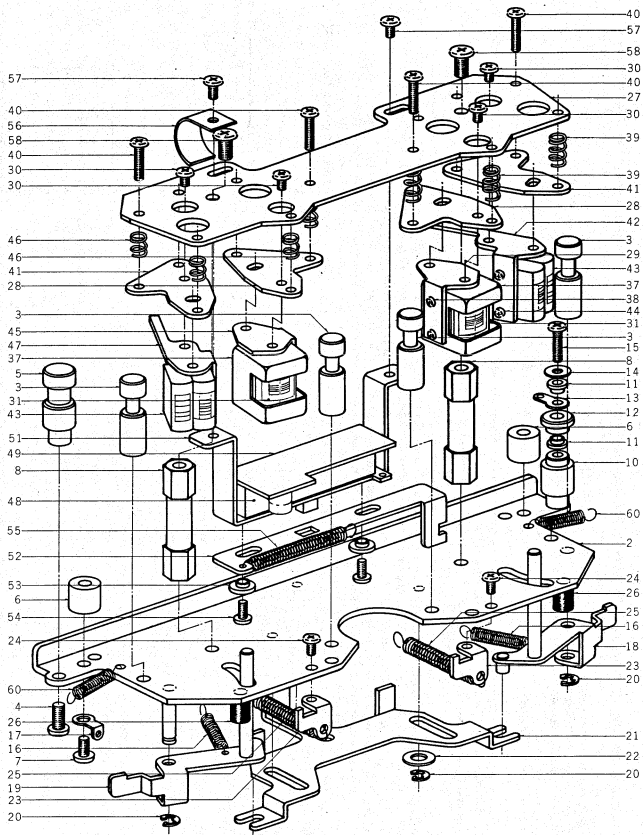

## ND HEAD BLOCK

Ref. No.	Parts No.	Description	Schematic No.	Q'ty
1-1x	BH536354	ND Head Block Comp.		1
1-2	HZ527602	Head Sub Chassis, w/guide	ND-0001	1
1-3	HZ528581	Tape Guide A	ND-0006	4
1-4	ZW413201	Screw, pan head 4x8		5
1-5	HZ528592	Tape Guide B	ND-0007	1
1-6	MH528063	Panel Prop A	ND-0019	2
1-7	ZW419736	Screw, binding head 4x6		3
1-8	MH529233	Head Base Prop B	ND-0017	2
1-9x	ZW416687	Screw, binding head 4x8		2
1-10	HZ529301	Sensing Guide A	ND-0009	1
1-11	SE527455	Sensing Spacer	ND-0011	2
1-12	HZ528570	Sensing Guide B	ND-0010	1
1-13	ZW273778	Earth Lug M3		1
1-14	ZW425002	Washer (SPC)D3.1x8x0.5t		1
1-15	ZW413785	Screw, binding head 3x12		1
1-16	ZG232121	Tension Lever Spring	MH-143	2
1-17	ZW273881	Earth Lug M4		2
1-18	HL528085	Shifter Lever A, w/pin	ND-0016	1
1-19	HL528096	Shifter Lever B, w/pin	ND-0016	1
1-20	ZW270101	'E' Ring 3M	4-1-9	5
1-21	HL527444	Shifter Lever C	ND-0012	1
1-22	ZW396437	Washer (Polyslider)D5.1x10.3x 0.25t		3
1-23	HL528074	Shifter Spring Hook	ND-0018	2
1-24	ZW323728	Screw, binding head 3x5		2
1-25	ZG527477	Shifter Spring	ND-0024	2
1-26	MZ810191	RD Cushion Rubber	RD-278	2
1-27	HZ527466	Head Chassis	ND-0002	1
1-28	HZ527501	P.B. Head Base	ND-0003	2
1-29	HZ529470	P.B. Head Angle A	ND-0004	1
1-30	ZW396000	Screw, binding head 3x4		6
1-31	HP560698	P.B. HEAD P4-202-NA.		2
1-32x	HP560700	P.B. HEAD P4-202-NB		2
1-33x	HP560711	P.B. HEAD P4-202-NC		2
1-34x	HP560722	P.B. HEAD P4-202-ND		2
1-35x	HP560733	P.B. HEAD P4-202-NE		2
1-36x	EA463206	Terminal P.C. Board A	RD-A36	4
1-37	HZ527512	Head Shield	ND-0026	2
1-38	ZW460440	Screw, pan head 2x4		4
1-39	ZG466312	Angle Adjust Spring E	BS-0018	6
1-40	ZW536490	Screw, binding head 3x12		12
1-41	HZ527490	Erase Head Base	ND-0006	2
1-42	HZ527940	REC./E. Head Angle A	ND-0005	1
1-43	HR536365	REC./ERASE HEAD RE4-5		2
1-44	ZW461395	Screw, round head 2x3		4
1-45	HZ529481	P.B. Head Angle B	ND-0004	1
1-46	ZG364656	Angle Adjust Spring C	RD-57	6
1-47	HZ527951	REC./E. Head Angle B	ND-0005	1
1-48	ES520672	Slide Switch SL-282B4	25-3-88	1
1-49	EA527523	Head Change P.C. Board	ND-0025	1
1-50x	EO346500	Ferri Inductor FL7H 220μH(J)	23-1-3	1
1-51	HZ529288	Reverse Switch Base	ND-0013	1
1-52	HL527433	Reverse Lever	ND-0014	1
1-53	HZ527422	Graduated Washer	ND-0015	2
1-54	ZW487866	Screw, round head 2.6x6		2
1-55	ZG528041	Reverse Spring	ND-0023	1
1-56	HZ531584	Earth Plate	ND-0043	1
1-57	ZW304806	Screw, binding head 3x5		2
1-58	ZW537006	Screw, binding head 4x8		2
1-59x	EA382713	Head Connector P.C. Board	RD-AR	1
1-60	ZG529334	Tension Spring	ND-1016	2

When ordering parts, please describe Parts Number, Serial Number, and Model Number in detail.



FIG. 2 ILLUSTRATION OF MAIN MOTOR BLOCK

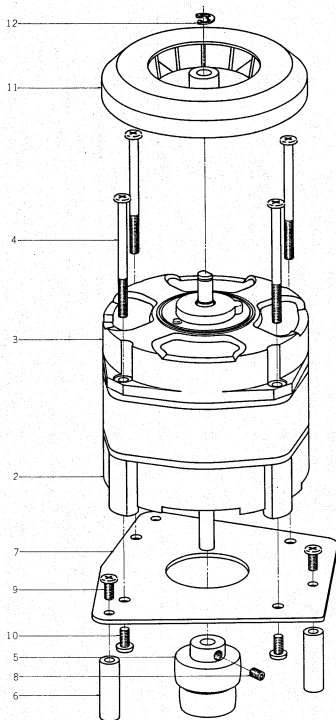

MAIN MOTOR BLOCK

Ref. No.	Parts No.	Description	Schematic No.	Q'ty	Ref. No.	Parts No.	Description	Schematic No.	Q'ty
2-1x	BM536253	Main Motor Block Comp.			2-7	MZ529097	Motor Mt. Plate	ND-7004	1
		HM2-16ND	ND-NC	1	2-8	ZW391476	Set Screw, hexagon socket 4x4 (cup)		2
2-2	MZ526421	16 Motor Cover Comp.	TW-78E3	1	2-9	ZW416687	Screw, binding head 4x8		3
2-3	MZ448222	24 Motor Cover Comp.	24X-781	1	2-10	ZW413201	Screw, pan head 4x8		4
2-4	ZW520593	Screw, pan head 4x52,		4					
		w/washer			2-11	SZ529108	Main Motor Fan	ND-7010	1
2-5	MR529277	Motor Pulley	ND-7001	1	2-12	ZW270134	'E' Ring 5M	6-1-9	1
2-6	MZ528827	Motor Prop	ND-7003	3					

When ordering parts, please describe Parts Number, Serial Number, and Model Number in detail.

FIG. 3 ILLUSTRATION OF REEL MOTOR/REEL TABLE BLOCK

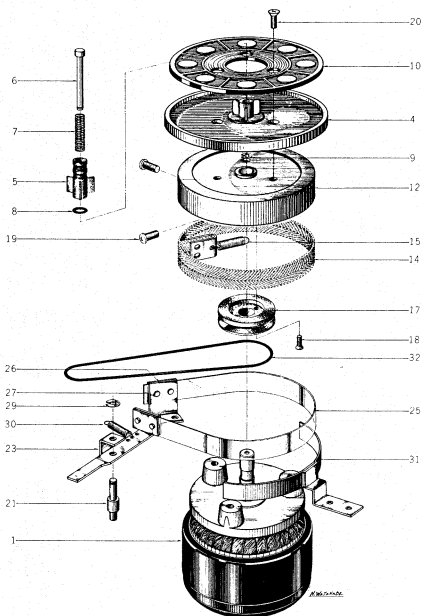

REEL MOTOR/REEL TABLE BLOCK

Ref. No.	Parts No.	Description	Schematic No.	Q'ty	Ref. No.	Parts No.	Description	Schematic No.	Q'ty
3-1	BM314741	Reel Motor Block (24XO-2)		1	3-17	MR317507	Counter Pulley (Take-up)	MR-217	1
		Comp. MR, MS, KF			3-18	ZW365973	Screw, countersunk head 2.3x12 (Take-up)		2
3-2x	BR482400	Reel Table Block Comp.		1	3-19	ZW424056	Screw, pan head 4x10		2
		(Supply) ND, KH			3-20	ZW403222	Screw, countersunk head 3x10		3
3-3x	BR482411	Reel Table Block Comp.		1					
		(Take-up) ND, KH							
3-4	MT488147	RD Reel Table Disk B	RD-272	1					
3-5	MT255420	Reel Retainer	SR-102	1	3-21	MZ317373	Brake Lever Prop	MR-102	2
3-6	MS342000	Reel Shaft	SR-108	1	3-22x	ZW413188	Nut M4		2
3-7	ZG255633	Reel Spring	SR-109	1	3-23	ML314976	Brake Lever A (Take-up)	MR-210	1
3-8	MT297663	3R 'O' Ring 2.9x1.65M	SR-129	1	3-24x	ML396810	Brake Lever B (Supply)	KD-1038	1
3-9	ZW270088	'E' Ring 1.9M	6-1-9	1	3-25	MB314987	Brake Band	MR-213	2
3-10	MT473422	Reel Table Rubber (KH)	KH-2042	1	3-26	MZ314998	Brake Band Retaining Plate	MR-212	4
3-11x	MT473444	Brake Drum (L) (Supply)	KH-2031	1	3-27	MZ315000	Brake Band Support	MR-214	2
3-12	MT473433	Brake Drum (R) (Take-up)	KH-2031	1	3-28x	ZW323728	Screw, binding head 3x5		8
3-13x	ZW273778	Earth Lug M3		1	3-29	ZW290283	'U' Ring 2.85M	6-1-1	2
3-14	MT436860	Brake Cloth Comp.	MR-269	1	3-30	ZG540551	Brake Spring	ND-1076	2
3-15	ZG317496	Felt Tension Spring	MR-260	1	3-31	MZ317406	Brake Band Guide, w/base	MR-120	2
3-16x	ZW425981	Screw, binding head 3x3		1	3-32	MB527556	Counter Belt D93x1.5	ND-1022	1

When ordering parts, please describe Parts Number, Serial Number, and Model Number in detail.

FIG. 4 ILLUSTRATION OF FLYWHEEL BLOCK

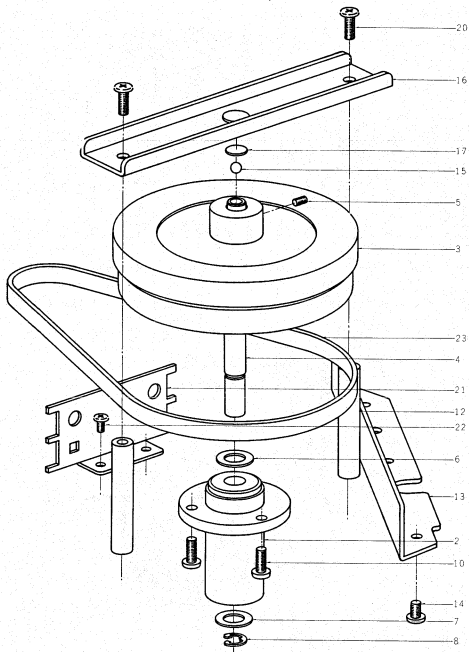

**FLYWHEEL BLOCK**

Ref. No.	Parts No.	Description	Schematic No.	Q'ty	Ref. No.	Parts No.	Description	Schematic No.	Q'ty
4-1x	BF536264	Flywheel Block Comp. (ND)		1	4-11x	ZW273881	Earth Lug M4		1
4-2	BC529492	Main Case Comp.	ND-2006	1	4-12	MA453756	Thrust Prop	BS-1023	2
4-3	M1455747	Flywheel	BS-2026	1	4-13	MZ540527	Frame Reinforce Plate	ND-1077	2
4-4	MS529626	Capstan Shaft	ND-2005	1	4-14	ZW419736	Screw, binding head 4x6		6
4-5	ZW373577	Set Screw, hexagon socket		1	4-15	MV269965	Steel Ball D4		1
		5x6 (flat)		2	4-16	MZ453767	Thrust Bracket	BS-1022	1
4-6	MZ437804	Flywheel Thrust A D7.9x13x1t	101028	1	4-17	ZW462205	Washer, without hole D7.9x1t		1
4-7	ZW260278	Washer (Nylon) D8.1x13x0.5t		1	4-18x	ZW330412	Adjust Washer(U)D4x13x0.13t		1
4-8	ZW270156	'E' Ring 6M	6-1-9	1	4-19x	ZW330423	Adjust Washer(U)D4x13x0.25t		1
4-9x	EZ244124	Felt D13x17x1t		1	4-20	ZW435273	Screw, binding head 4x10		2
					4-21	MS527804	Belt Guide	ND-1069	1
					4-22	ZW323728	Screw, binding head 3x5		2
					4-23	MB238768	RD Drive Belt D120x1.6x7	(flat) RD-129	1
<b>MECH. ASSEMBLY BLOCK</b>									
4-10	ZW416687	Screw, binding head 4x8		3					

When ordering parts, please describe Parts Number, Serial Number, and Model Number in detail.

FIG. 5 ILLUSTRATION OF OPERATION BLOCK

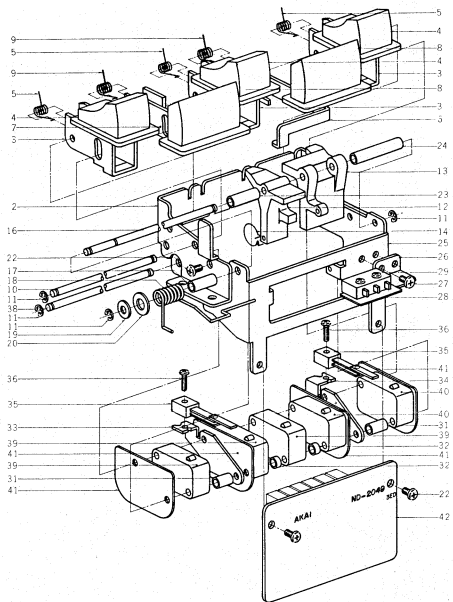

**OPERATION BLOCK**

Ref. No.	Parts No.	Description	Schematic No.	Q'ty	Ref. No.	Parts No.	Description	Schematic No.	Q'ty
	5-22	ZW467537			5-23	SE530392	Spacer D	ND-2058	1
							w/washer		6
5-1x	BZ536275	Operation Block Comp.	ND	1	5-24	SE530403	Spacer E	ND-2059	1
5-2	MZ528175	Keyboard Holder	ND-2030	1	5-25	ML527782	Switch Retaining Table	ND-2039	1
5-3	ML528186	Keyboard Arm A	ND-2031	3	5-26	ML529896	Switch Retaining Bracket	ND-2052	1
5-4	SK528197	Keyboard Knob A	ND-2032	3	5-27	ZW323728	Screw, binding head 3x5		2
5-5	ZG529143	Keyboard Return Spring A	ND-2033	3	5-28	EZ528344	Insulator Fiber	ND-2053	1
5-6	ML527758	Keyboard Arm B	ND-2034	1	5-29	ES477966	Micro Switch SS-5L	Z5-1-23	1
5-7	ML527747	Keyboard Arm C	ND-2035	1	5-30x	ZW461261	Screw, binding head 2.5x8		2
5-8	SK527736	Keyboard Knob B	ND-2036	2	5-31	SE529176	Spacer B	ND-2046	2
5-9	ZG529154	Keyboard Return Spring B	ND-2037	2	5-32	SE529187	Spacer C	ND-2047	2
5-10	MS528480	Keyboard Shaft A	ND-2038	2	5-33	ML529198	Leaf Switch Mt. Plate A	ND-2048	1
5-11	ZW270088	'E' Ring 1.9M	6-1-9	11	5-34	ML529200	Leaf Switch Mt. Plate B	ND-2048	1
5-12	ML527771	Micro Switch Arm A	ND-2040	1	5-35	ES520604	Leaf Switch BSW-3201-01	Z5-1-15	2
5-13	ML527760	Micro Switch Arm B	ND-2041	1	5-36	ZW536488	Screw, binding head 2x8		2
5-14	ZG528917	Turn Spring A (Left)	ND-2042	1	5-37x	ZW273778	Earth Lug M3		1
5-15x	ZG528928	Turn Spring B (Right)	ND-2042	1	5-38	MS528491	Keyboard Shaft B	ND-2038	2
5-16	MS527411	Arm Shaft	ND-2043	1	5-39	ES403727	Micro Switch V-1A106 U/L	Z5-1-20	3
5-17	SE529165	Spacer A	ND-2044	1	5-40	ES520064	Micro Switch V-1A44 U/L	Z5-1-7	2
5-18	ZG528287	Switch Cancellation Spring	ND-2045	1	5-41	MZ402377	Micro Insulator D	KD-2050	4
5-19	ZW536466	Washer (Nylon) D2.1x7x0.5t		2	5-42	BAS36286	Spark Quencher P.C. Board Comp. (ND-2049)		1
5-20	ZW259986	Washer (Nylon) D5.1x10.3x1t		1					
5-21x	ZW536477	Washer (Nylon) D3.5x8x0.5t		1					

When ordering parts, please describe Parts Number, Serial Number, and Model Number in detail.

FIG. 6 ILLUSTRATION OF SPEED SWITCH BLOCK

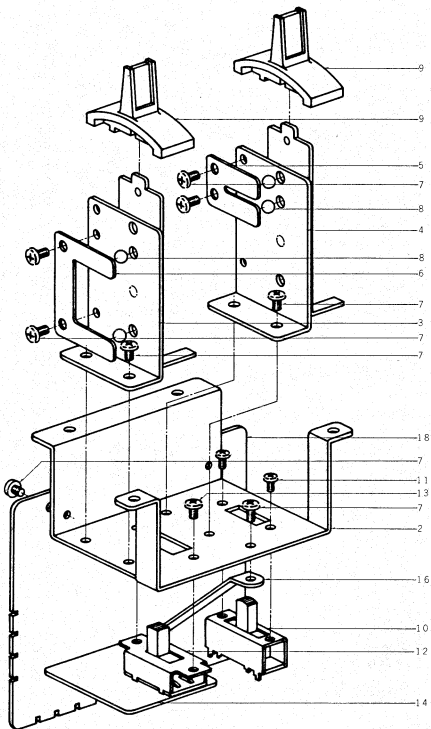

SPEED SWITCH BLOCK

Ref. No.	Parts No.	Description	Schematic No.	Q'ty	Ref. No.	Parts No.	Description	Schematic No.	Q'ty
6-1x	BS536297	Speed Switch Block Comp.	ND	1	6-11	ZW419782	Screw, binding head 2.6x5		2
6-2	ML527973	Switch Base	ND-2018	1	6-12	ES479485	Slide Switch S-1	25-3-66	1
6-3	ML528142	Switch Lever A, w/bracket B	ND-2020	1	6-13	ZW371856	ISO Screw, binding head 3x5		2
6-4	ML529132	Switch Lever B, w/bracket B	ND-2021	1	6-14	EA527668	Speed Change P.C. Board	ND-2027	1
6-5	ZG529435	Plate Spring A, Ball Retainer	ND-2024	1	6-15x	ER213715	Carbon/R. RD1/4 100k(I)		1
6-6	ZG529424	Plate Spring B, Ball Retainer	ND-2025	1			(Insu. type)	35-9-5	1
6-7	ZW472274	Tapping Screw #2 3x6 (binding)		11	6-16	EL527567	P.C. Board Supporting	ND-2028	1
6-8	MV269965	Steel Ball D4		4	6-17x	ZW273778	Earth Lug M3		1
6-9	SK528603	Switch Knob	ND-2029	2	6-18	BA536308	Condenser P.C. Board Comp. (ND-2026)		1
6-10	ES449796	Slide Switch SL-223B4	25-3-59	1	6-19x	ZW413728	Screw, binding head 3x6, w/washer		1

When ordering parts, please describe Parts Number, Serial Number, and Model Number in detail.

FIG. 7 ILLUSTRATION OF POWER SUPPLY/REAR PLATE BLOCK

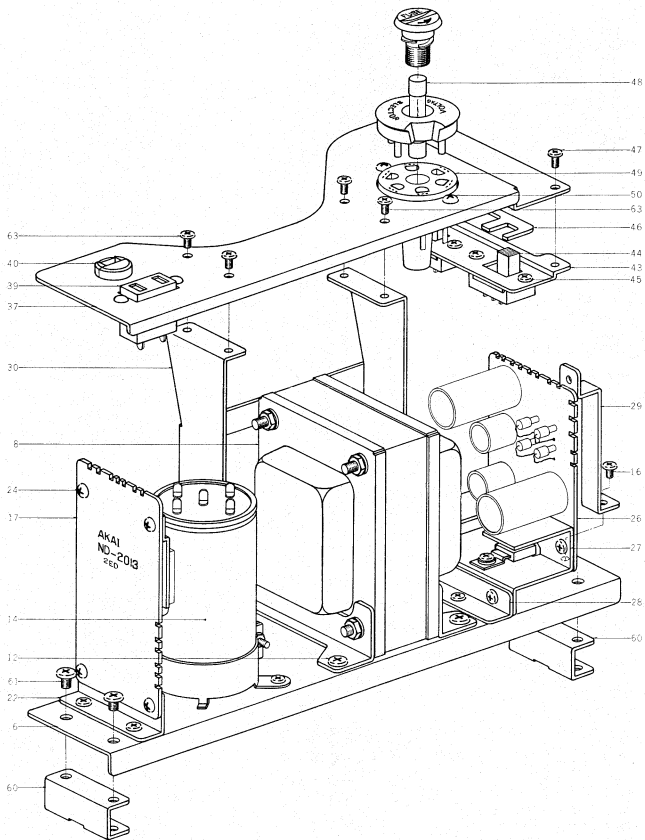

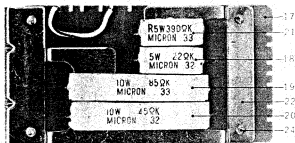

## POWER SUPPLY/REAR PLATE BLOCK

Ref. No.	Parts No.	Description	Schematic No.	Q'ty
<b>POWER SUPPLY BLOCK</b>				
7-1x	BFS36310	Power Supply Block Comp.	ND	1
7-2x	BFS36747	Power Supply Block Comp. (UL)	ND	1
7-3x	BFS36758	Power Supply Block Comp. (CSA)	ND	1
7-4x	BFS36995	Power Supply Block Comp. (3 core)	ND	1
7-5x	BFS61161	Power Supply Block Comp. (EC)	ND	1
7-6	MZ527815	Power Supply Mt. Base	ND-2008	1
7-7x	MZ546603	Power Supply Mt. Base (EC)	ND-2008	1
7-8	BT520615	Power Trans. NDT-1	38-4-210	1
7-9x	BT536916	Power Trans. NDT-2 (UL)	38-4-222	1
7-10x	BT536951	Power Trans. NDT-3 (CSA)	38-4-220	1
7-11x	BT561205	Power Trans. NDT-5 (EC)	38-4-221	1
7-12	ZW468112	Tapping Screw #2 4x8 (truss)		4
7-13x	ZW419736	Screw, binding head 4x6 (EC)		4
7-14	EC520626	MP/JC. (3+1)F x 2 250WVAC (Lug type Uni/D.)	24-9-74	1
7-15x	EC536927	MP/JC. 3 $\mu$ F x 2 250WVAC (Lug type Uni/D.) (UL, CSA)	24-9-79	1
7-16	ZW472274	Tapping Screw #2 3x6 (binding)		5
7-17	BA527376	Resistor P.C. Board Comp. (ND-2013)		1
7-18	ER465750	Cement/R. 5W 22 $\Omega$ (K) (Wire-wound type)	35-16-3	1
7-19	ER550585	Cement/R. 10W 85 $\Omega$ (K) (Wire-wound type)	35-16-5	1
7-20	ER520648	Cement/R. 510W 45 $\Omega$ (K) (Wire-wound type)	35-16-5	1
7-21	ER550574	Cement/R. 5W 390 $\Omega$ (K) (Metal Ox. Film/T)	35-16-13	1
7-22	MZ528164	Resistor Mt. Metal Fitting	ND-2014	1
7-23x	ER552813	Cement/R. H10B 85 $\Omega$ (K) (CSA)	35-16-46	1
7-24	ZW447772	Tapping Screw #2 3x6 (BR)		8
7-25x	ZW472274	Tapping Screw #2 3x6 (binding)		2
7-26	BA536321	Power Supply P.C. Board Comp. (ND-2010)		1
7-27	EZ480396	Heat-sink Plate	1E-5010	1
7-28	MZ528805	Heat-sink Retaining Plate	ND-2011	1
7-29	MZ529110	P.C. Board Retaining Plate C	ND-2012	1
7-30	MZ527826	Rear Plate Retaining Angle	ND-2009	1
7-31x	EZ516464	AC Cord 2.5M (CSA)	26-3-29	1

Ref. No.	Parts No.	Description	Schematic No.	Q'ty
<b>REAR PLATE BLOCK</b>				
7-32x	BZ536332	Rear Plate Block Comp.	ND	1
7-33x	BZ536760	Rear Plate Block Comp. (UL)	ND	1
7-34x	BZ536771	Rear Plate Block Comp. (CSA)	ND	1
7-35x	BZ536736	Rear Plate Block Comp. (3 core)	ND	1
7-36x	BZ561183	Rear Plate Block Comp. (EC)	ND	1
7-37	EZ529413	Rear Plate	ND-2015	1
7-38x	EZ546614	Rear Plate B (EC)	ND-2015	1
7-39	EJ378944	U/L AC Socket S-1 9122	31-1-47	1
7-40	EZ382263	Strain Relief SR-4K-4	2-7-12	1
7-41x	EW540112	AC Cord 2.5M	26-3-19	1
7-42x	EC559260	Power Cord TYPE-412 (EC)	26-3-33	1
7-43	EZ529121	Slide Switch Mt. Plate	ND-2017	1
7-44	ES479485	Slide Switch S-1	25-3-86	2
7-45	ZW444273	ISO Screw, binding head 3x4		4
7-46	EZ527850	Switch Slide Plate	ND-2016	1
7-47	ZW417137	Screw, binding head 3x4		2
7-48	EF277413	Fuse ST-2 2A	28-1-26	1
7-49	EJ233370	Power Plug Socket S-18010	40-2-3	1
7-50	ZW372025	ISO Screw, truss head 3x6		2
7-51x	EJ536940	Fuse Holder, screw type (UL)	40-2-8	1
7-52x	EA480925	Fuse Terminal Plate 1 (CSA)	101061	1
7-53x	EF524722	Fuse 125V 1.2A (CSA)	39-1-44	4
7-54x	ZWS61227	Connector 6E-2SD (EC)	52-1-18	1
7-55x	ZWS46625	Connector Insulator (EC)	ND-1081	1
7-56x	EJ546636	Fuse Holder B (EC)	A0392	1
7-57x	EF513663	Fuse 800MAT (T type) (EC)		4
7-58x	EZ246936	Strain Relief SR-6W-1 (3 core)	2-7-8	1
7-59x	EZ315448	Australia Cord (3 core)	26-3-11	1

7-60	MZ527545	Power Supply Angle	ND-1009	2
7-61	ZW419736	Screw, binding head 4x6		4
7-62x	ZW273881	Earth Lug M4		1
7-63	ZW396000	Screw, binding head 3x4		4

### MECHANISM ASSEMBLY BLOCK

Ref. No.	Parts No.	Description	Schematic No.	Q'ty
8-1	MZ529255	Mech. Frame	ND-1001	1
8-2	MH529312	Head Base Prop A	ND-1002	4
8-3x	ZW435273	Screw, binding head 4x10		4
8-4	MZ528107	Lever Pin	ND-1005	1
8-5x	ZW413278	Nut M5		2
8-6	MS528456	Pinch Roller Arm Shaft	ND-1010	1
8-7	MS527534	Reverse Guide	ND-1011	1
8-8x	ZW413188	Nut M4		7
8-9	MH527916	Reverse Joint Prop	ND-1014	1
8-10	MH527905	Reverse Prop	ND-1018	1
8-11	MS465480	Brake Lever Shaft B	ND-1093	1
8-12x	ZW273756	Nut M3		1
8-13	MS397012	Brake Lever Shaft	KD-1003	2
8-14	MZ317373	Brake Lever Prop	MR-102	2
8-15	ML527837	Brake Lever, w/pin	ND-1060	1
8-16	ML529244	Switch Plate	ND-1061	1
8-17	ZW417137	Screw, binding head 3x4		3
8-18	MZ397181	Lever Cushion	KD-1069	1
8-19	ZW290283	'U' Ring 2.85M	6-1-1	8
8-20	MZ314605	MR Spring Rack	MR-104	2
8-21	ZW323728	Screw, binding head 3x5		18
8-22	ML314976	Brake Lever A (Take-up)	MR-210	1
8-23	ML396810	Brake Lever B (Supply)	KD-1038	1
8-24	MB314987	Brake Band	MR-213	2
8-25	MZ314998	Brake Band Retaining Plate	MR-212	4
8-26	MZ315000	Brake Band Support	MR-214	2
8-27	ZG540551	Brake Spring	ND-1076	2
8-28	ML529525	ND Brake Lever A, w/pin	KD-1039	1
8-29	ZG465478	Brake Lever Spring	KD-1092	1
8-30	EP554747	Plunger Solenoid SDC-953		
			FHT 44-1-58	1
8-31x	ED224561	Silicon Diode 10D6	45-2-17	1

When ordering parts, please describe Parts Number, Serial Number, and Model Number in detail.



Ref. No.	Parts No.	Description	Schematic No.	Q'ty	Ref. No.	Parts No.	Description	Schematic No.	Q'ty	
8-32	ML528131	Plunger Base	ND-1058	1	8-102	ML528513	Switch Pin	ND-1055	1	
8-33x	ZW371856	ISO Screw, binding head 3x5		4	8-103x	MH527635	Switch Pipe	ND-1054	1	
8-34	MZ529863	Brake Plunger Joint	ND-1064	1	8-104	ZG529211	Switch Spring	ND-1053	1	
8-35	ZW257477	Connecting Pin	RD-211	1	8-105	ML529391	Quick Plate	ND-1063	1	
8-36	ZW270088	'E' Ring 1.9M	6-1-9	1	8-106	ES250064	Micro Switch V-1A44 U/L	25-1-7	1	
8-37	ES403727	Micro Switch V-1A106 U/L	25-1-20	6	8-107	MZ250413	Micro Insulator C	RC-127	1	
8-38	MZ479834	Micro Insulator S	MS-1020	2	8-108	ML529345	P Spring Rack	ND-1019	1	
8-39x	ZW486314	Screw, binding head 3x28		2	8-109	ZG528118	P Spring	ND-1004	1	
8-40x	ZW397146	Micro Switch Nut	KD-1057	1	8-110	ML527962	Lamp P.C. Board Mt. Table	ND-1052	2	
8-41	ML2250413	Micro Insulator C	RC-127	2	8-111	EA527624	Lamp P.C. Board	ND-1051	2	
8-42x	ZW417148	Screw, binding head 3x15		4	8-112x	EL295312	No.2 Lamp 8V 0.2A (IND1,2)	28-2-8	2	
8-43x	ZW414066	Screw, binding head 3x25		2	8-113x	ZW413223	Screw, binding head 3x5, w/washer		2	
8-44x	ZW330412	Adjust Washer D4x13x0.13t	(U)	1	8-114	MS527400	Tension Arm Shaft	ND-1003	2	
8-45x	ZW330423	Adjust Washer D4x13x0.25t	(U)	1	8-115	ML528478	Tension Arm A, w/pole	ND-1040	1	
8-46x	ZW330445	Adjust Washer D4x13x0.8t	(U)	1	8-116	ZW487811	Washer (Polyslider)D4.1x7x 0.5t	6-1-1	2	
8-47	ML528445	P Lever	ND-1036	1	8-117	ZW290283	'U' Ring 2.85M	ND-1040	1	
8-48	MS527591	Pinch Roller Shaft	ND-1030	1	8-118	ML528794	Tension Arm B, w/metal	MR-36	2	
8-49x	ZW274026	Spring Washer M5		1	8-119	HZ317632	Insulator Collar A		1	
8-50x	ZW413278	Nut M5		1	8-120	ZW273778	Earth Lug M3		1	
8-51	MZ529727	P Joint Pin B	ND-1034	1	8-121	HZ425485	Sensing Collar	MS-2015	1	
8-52	MZ527848	P Joint	ND-1035	1	8-122	ML528546	Sensing Top	ND-1043	1	
8-53	ZW536444	Screw, binding head 4x18		1	8-123	ZW536445	Screw, binding head 2.3x18		1	
8-54	ZG527580	Quick Spring	ND-1021	1	8-124	ES479395	Push Switch TV-3 JH5	25-5-62	1	
8-55	ML529222	P Plunger Lever, w/pin	ND-1033	1	8-125x	ES561194	Push Switch AC250V 4A	285/10 (EC)	25-5-110	1
8-56	MZ529378	Shift Adjuster	ND-1032	1	8-126	ML527613	Power Switch Table	ND-1050	1	
8-57	ZW417137	Screw, binding head 3x4		6	8-127x	ML546557	Power Switch Table B (EC)	ND-1083	1	
8-58	MZ529356	Pinch Roller Joint B	ND-1027	1	8-128	ZW371856	ISO Screw, binding head 3x5		1	
8-59	ZG529367	Cramp Spring	ND-1029	1	8-129	SK518477	Fush Switch Knob B	RD-506	1	
8-60	ML802980	Spring Holder	RD-276	2	8-130x	ER226798	Spark Quencher 0.1μ+120		1	
8-61	ZW413188	Nut M4		4	8-131x	EA546570	Switch P.C. Board (EC)	250WV 41-1-10	1	
8-62	MZ528557	P Joint Pin A	ND-1028	1	8-132x	SK546581	Push Switch Knob A (EC)	ND-1080	1	
8-63	ZW270088	'E' Ring 1.9M	6-1-9	2	8-133x	ES494188	Micro Switch SS-SGL-13(EC)	25-1-25	1	
8-64x	ZW345442	Washer (Nylon)D4.2x9x1t		1	8-134x	ZW345442	Washer (Nylon)D4.2x9x1t	(EC)	1	
8-65	ZW270156	'E' Ring 6M	6-1-9	1	8-135x	ML527861	Switch Plate (EC)	ND-1057	1	
8-66	EP520558	Plunger Solenoid SDC-1064FHT	44-1-51	1	8-136x	ZW546592	Switch Barrier (EC)	ND-1082	1	
8-67x	ED224561	Silicon Diode 10D6	45-2-17	1	8-137x	EZ528344	Insulator Fiber (EC)	ND-2053	1	
8-68	MZ527578	Plunger Bracket	ND-1037	1	8-138x	ZW417328	Screw, binding head 2.3x10	(EC)	2	
8-69x	ZW371856	ISO Screw, binding head 3x5		8	8-139	ZW323728	Screw, binding head 3x5	19		
8-70	MZ529648	P Plunger Joint	ND-1038	1	8-140x	EC520516	Elect, J. 330μF 200WV	(Lug type)	24-10-75	1
8-71x	ZW257477	Connecting Pin	RD-211	1	8-141x	ER365016	Carbon/R. RD1/4 220K(J)	(Insu. type)	35-9-5	1
8-72x	ZW270101	'E' Ring 3M	6-1-9	2	8-142x	EC314662	MP/C. 2+1μF 250WVAC	(Lug type Uni/D.)	24-9-34	1
8-73	ZW323728	Screw, binding head 3x5		9	8-143x	EC536938	MP/C. 2μF 250WVAC (Lug type Uni/D.) (UL, CSA)	24-9-78	1	
8-74	ML530043	Lever Holder	ND-1070	1	8-144x	ZW424056	Screw, pan head 4x10		6	
8-75	MZ527646	FF Reset Lever A, w/pin	ND-1006	1	8-145	MC520536	Counter MP-490-18	9-1-27	1	
8-76x	ZW396437	Washer (Polyslider) D5.1x10.3x0.25t		1	8-146	ZW417137	Screw, binding head 3x4		2	
8-77	ZW290283	'U' Ring 2.85M	6-1-1	7	8-147x	MBS27556	Counter Belt	ND-1022	1	
8-78	ZG527938	FF Reset Spring	ND-1024	2	8-148	MZ527894	Panel Support	ND-1020	1	
8-79	ML529323	FF Reset Guide	ND-1015	1	8-149x	ZW447772	Tapping Screw #2 3x6(BR)		2	
8-80	ML529738	FF Reset Lever B	ND-1007	1	8-150	ES389700	Micro Switch SS-5	25-1-19	1	
8-81	EP520560	Plunger Solenoid SDC-953THT	44-1-52	1	8-151	EZ528344	Insulator Fiber	ND-2053	1	
8-82x	ED224561	Silicon Diode 10D6	45-2-17	1	8-152	ML527861	Switch Plate	ND-1057	1	
8-83	ML528131	Plunger Base	ND-1058	1	8-153x	ZW417328	Screw, binding head 2.3x10		2	
8-84	MZ529650	Reverse Joint D, w/pi	ND-1059	1	8-154x	EJ299834	6P Mate-N-Lock Plug Housing	1-480273-0	52-1-2	1
8-85	ML529380	D Switch Lever	ND-1056	1	8-155x	EJ373634	Socket Contact #1115-1	52-1-1	6	
8-86	ZW257477	Connecting Pin	RD-211	1	8-156	MZ317406	Brake Band Guide, w/base	MR-120	2	
8-87	ZW270088	'E' Ring 1.9M	6-1-9	2	8-157	ZG529334	Tension Spring	ND-1016	2	
8-88	MZ527657	Reverse Joint A, w/pin	ND-1012	1	8-158x	EZ496686	Wire Clip 220J D486010-119	2-7-16	2	
8-89	MZ527883	Reverse Joint B	ND-1021	1	8-159x	MB229138	Wire Bundle Holder	2-35-1	5	
8-90	ES438535	Micro Switch V-1A442 U/L	25-1-15	1	8-160x	EJ205986	Crimp Terminal 2-SD	32-1-8	13	
8-91	MZ250413	Micro Insulator C	RC-127	1	8-161	MP275984	RD Pinch Roller	RD-221	1	
8-92	ML527984	AS Switch Table, w/prop	ND-1045	1	8-162x	ER552813	Cement/R. H10B 85Q (K)	(EC)	35-16-46	1
8-93x	ZW417148	Screw, binding head 3x15		4	8-163	SZ527681	Pinch Roller Set Screw	ND-6019	1	
8-94	MZ529558	AS Rotary	ND-1066	1	8-164	SZ528838	Panel Support A (Right)	ND-6005	1	
8-95	ZW413785	Screw, binding head 3x12		2	8-165x	SZ528840	Panel Support B (Left)	ND-6005	1	
8-96	ZW424495	Washer (SPC)D3.1x8x1t		1	8-166	MZ527927	Amp. Supporting Plate C	ND-1025	1	
8-97	ZW273756	Nut M3		2						
8-98	ML529290	AS Lever	ND-1047	1						
8-99	ZW200777	Set Screw, 3x6 (cone)		1						
8-100x	ZW259738	Washer (Polyslider)D4.1x7x0.25t		2						
8-101	ML528153	Quick Switch Table, w/shaft	ND-1062	1						

When ordering parts, please describe Parts Number, Serial Number, and Model Number in detail.

FIG. 9 ILLUSTRATION OF AMPLIFIER ASSEMBLY BLOCK

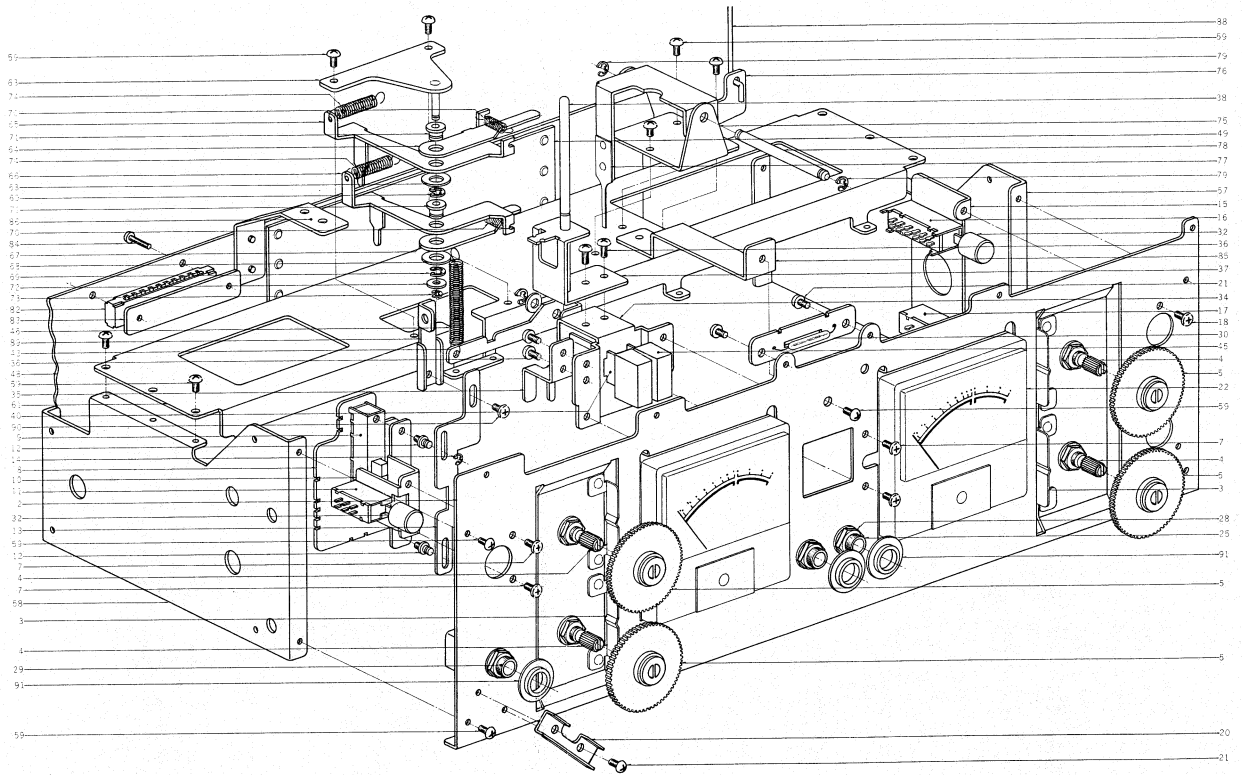
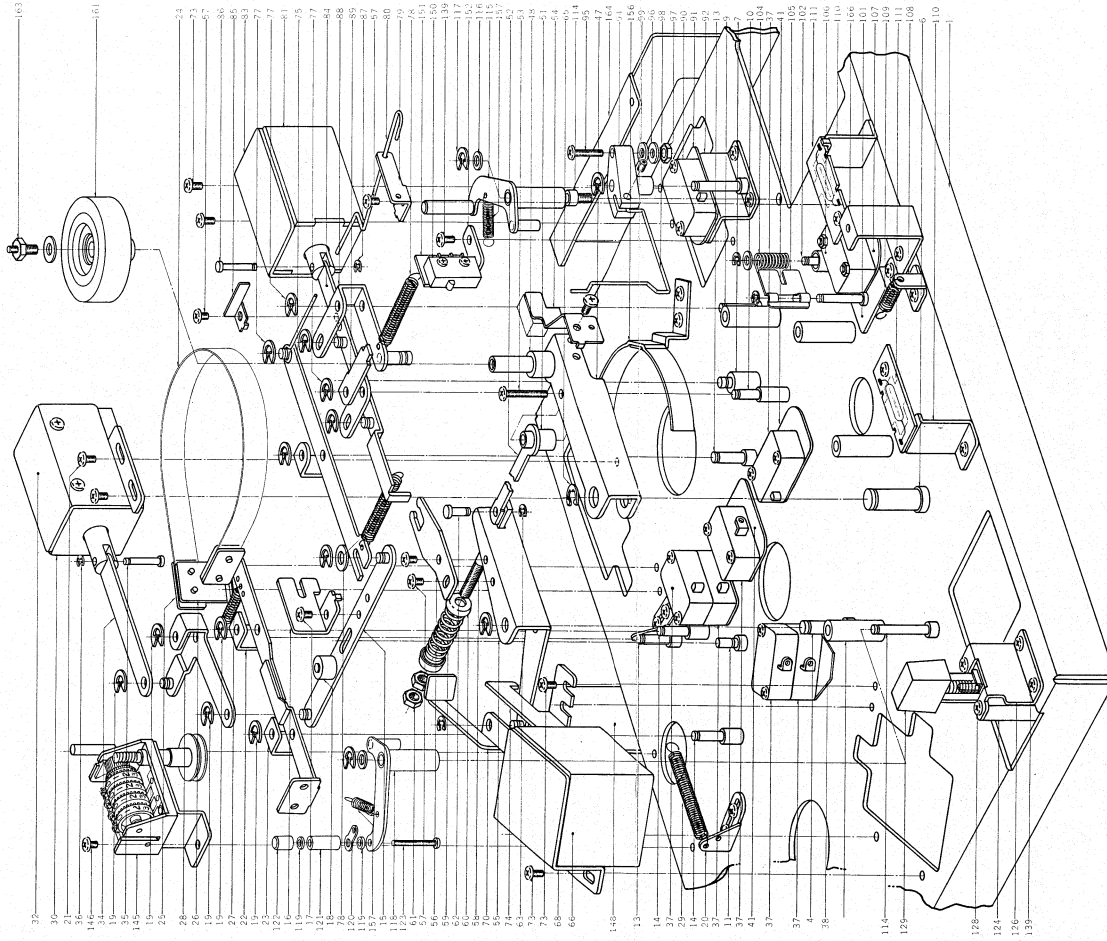

FIG. 8 ILLUSTRATION OF MECHANISM ASSEMBLY BLOCK



## AMPLIFIER ASSEMBLY BLOCK

Ref. No.	Parts No.	Description	Schematic No.	Q'ty	Ref. No.	Parts No.	Description	Schematic No.	Q'ty
<b>AMP. FRONT CHASSIS BLOCK</b>					<b>AMP. ASSEMBLY BLOCK</b>				
9-1x	BZ536387	Amp. Front Chassis Block			9-57	EZ528366	Amp. Side Plate R	ND-5020	1
		Comp. ND		1	9-58	EZ528377	Amp. Side Plate L	ND-5020	1
9-2	EZ529661	Amp. Front Chassis	ND-5001	1	9-59	ZW447772	Tapping Screw #2 3x6 (BR)		18
9-3	ZG529907	Click Spring	ND-5045	4	9-60x	ZW523664	Tapping Screw #2 3x10 (BR)		1
9-4	EV487822	Volume V24N 50 kA	36-2-28	4	9-61	EZ529560	Center Bridge	ND-5021	1
9-5	EZ529604	Click Gear	ND-5044	4	9-62x	ZW328320	Nylon Clip HP-5N	ND-5022	1
9-6x	BK536398	Rec. Button Block Comp.	ND	1	9-63	EZ528276	Lever Retaining Plate, w/shaft	ND-5022	1
9-7	ZW413155	Screw, binding head 3x6		5	9-64	ML528851	Sub R Lever A	ND-5025	1
9-8	BS536400	Equalizer Switch P.C. Board			9-65	ML528873	Rec. Lever A	ND-5026	1
		Comp. (ND-5042)		1	9-66	ML528884	Rec. Lever B	ND-5027	1
9-9	ES520672	Slide Switch SL-282B4	25-3-88	1	9-67	ML541484	Sub R Lever C	ND-5053	1
9-10	EZ528232	Switch Bracket A	ND-5012	1	9-68	ZW379361	Washer (Nylon)D6.1x13x0.5t		2
9-11	ES520705	Push Switch UEG-22A	25-5-78	1	9-69	ZW270123	'E' Ring 4M	6-1-9	2
9-12	VM422381	Slide Plate Shaft	PX-A206	2	9-70	ZG528423	Rec. Pull Spring A	ND-5028	2
9-13	EZ528210	Link B	ND-5014	1	9-71	ZW544083	Sleeve	ND-5055	2
9-14	ZW357164	'E' Ring 2.3M		2	9-72	ZW317171	Washer (PBP)D3.1x8x0.1t		3
9-15	EZ528265	Switch Angle	ND-5015	1	9-73	ZW270088	'E' Ring 1.9M	6-1-9	1
9-16	ES494594	Push Switch UEG42A	25-5-70	1	9-74	ZG529683	Rec. Pull Spring B	ND-5029	2
9-17	ES520705	Push Switch UEG-22A	25-5-78	1	9-75	EZ528682	RA Shaft Retaining Plate	ND-5030	1
9-18	ZW413155	Screw, binding head 3x6		2	9-76	ML528434	Reverse Arm A	ND-5033	1
9-19x	ZW432843	Screw, binding head 2.6x4		3	9-77	ML529806	Reverse Arm B	ND-5033	1
9-20	EZ528243	Support	ND-5018	2	9-78	MS529582	Reverse Arm Shaft	ND-5031	1
9-21	ZW447772	Tapping Screw #2 3x6 (BR)		6	9-79	ZW270101	'E' Ring 3M	6-1-9	2
9-22	EM520694	VU Meter KL-250B-20 (blue)			9-80x	EJ299823	6P Mate-N-Lock Cap Housing	1-480276-0	52-1-2
		(AAL, WG, JPN)	46-1-67	2					
9-23x	EM561756	VU Meter KL-250B-27 (black)	46-1-79	1	9-81x	EJ373623	Pin Contact 61116-1	52-1-1	6
9-24x	ZG290878	VU Meter Spring	DX-504	4	9-82	EJ292961	10P Multi-Jack 500-010-005	31-4-4	1
9-25	EJ433844	Mic. Jack 2PMJ4	31-2-35	2	9-83	EZ530021	Jack Nut Plate	ND-5052	1
9-26x	ZW272722	Toothed Lock Washer M9			9-84	ZW462947	Screw, pan head 2.3x12		2
		D9.3x13x0.5t		3	9-85	EZ528963	Amp. Supporting Plate A	ND-5040	1
9-27x	ZW260368	Washer (Fiber)D9.2x18x0.5t		2	9-86	EZ528952	Amp. Supporting Plate B	ND-5041	1
9-28	ZW270191	E Jack Nut		3	9-87x	ZW413155	Screw, binding head 3x6		2
9-29	EJ442078	Mic. Jack 3PMJ4	31-2-36	1	9-88	SZ528412	Reverse Switch Rod	ND-5034	1
9-30	EA528254	Rec. Lamp P.C. Board	ND-5016	1	9-89	SZ528221	Link A	ND-5013	1
9-31x	EL295312	No. 2 Lamp 8V 0.2A	28-2-8	1	9-90	ZW413728	Screw, binding head 3x6, w/washer		1
9-32	SK487675	Knob C	CG-2007	3	9-91	ZW526577	Collar B, Jack	MC-5006	3
<b>REC. BUTTON BLOCK</b>									
9-33x	BK536398	Rec. Button Block Comp.	ND	1					
9-34	EZ528333	Rec. Switch Holder, w/shaft	ND-5002	1					
9-35	EZ528208	Safety Guide	ND-5010	1					
9-36	ZW325495	Tapping Screw #2 3x6		4					
9-37	EZ528298	Rod Stand	ND-5008	1					
9-38	EZ528930	Rec. Con Rod	ND-5009	1					
9-39x	ZW270101	'E' Ring 3M	6-1-9	2					
9-40	EZ528322	Switch Slider	ND-5004	2					
9-41x	ZG528311	Coil Spring	ND-5005	2					
9-42x	EZ528300	Spring Retainer	ND-5006	1					
9-43	EZ528467	Stopper	ND-5007	1					
9-44x	ZW420682	Washer (Nylon)D4.2x9x0.5t		1					
9-45	SK528671	Push Switch Knob	ND-5011	2					
9-46	ZG520716	RF Spring	3R-150	1					
<b>REAR CHASSIS BLOCK</b>									
9-47x	BZ536411	Rear Chassis Block Comp.	ND	1					
9-48	EZ529593	Amp. Rear Chassis	ND-5035	1					
9-49	BZ527387	Jack Plate Comp. GX-260D	ND-5050	1					
9-50x	ES379045	6P Slide Switch SJ-0282 (small)	25-3-38	1					
9-51x	EV520738	Co-axial 2-throw Volume							
		GM30A 10 kBx2	36-1-24	1					
9-52x	ER213794	Carbon/R. RD1/4 120k(J)							
		(Insu. type)	35-9-5	2					
9-53x	ER345712	Carbon/R. RD1/4 22k(J)							
		(Insu. type)	35-9-5	6					
9-54x	ER520740	Carbon/R. RD1/4 240(J)							
		(Insu. type)	35-9-5	2					
9-55x	ER329264	Carbon/R. RD1/4 2.2k(J)							
		(Insu. type)	35-9-5	2					
9-56x	ZW273778	Earth Lug M3		1					

FIG. 10 PHOTO OF SPARK QUENCHER  
P.C. BOARD (ND-2049)

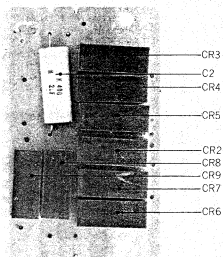
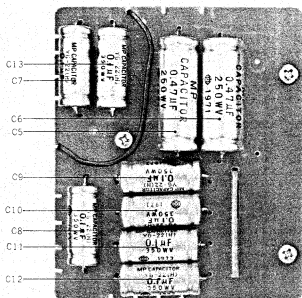

FIG. 11 PHOTO OF CONDENSER  
P.C. BOARD (ND-2026)



**SPARK QUENCHER P.C. BOARD  
(ND-2049) BLOCK**

Symbol No.	Parts No.	Description	Q'ty
10-1x	BA536286	Spark Quencher P.C. Board Comp. (ND-2049)	1
10-CR2 to 9	ER226798	Spark Quencher 0.1µ+120 250WV	8
10-C2	EC273464	MP Capacitor 0.1µF(M) 350WVDC (Tub. type)	1
10-R5	ER212264	Carbon Resistor RD1/4 22k(J) (Stop. type)	1

**CONDENSER P.C. BOARD (ND-2026) BLOCK**

Symbol No.	Parts No.	Description	Q'ty
11-1x	BA536308	Condenser P.C. Board Comp. (ND-2026)	1
11-C5, 6	EC350987	MP Capacitor 0.47µF (M) 250VAC (Tub. type)	2
11-C7 to 13	EC273464	MP Capacitor 0.1µF (M) 350WVDC (Tub. type)	7

FIG. 12 PHOTO OF POWER SUPPLY  
P.C. BOARD (ND-2010)

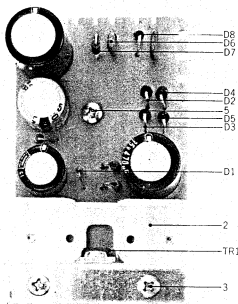
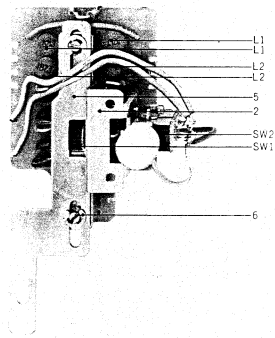

FIG. 13 PHOTO OF EQUALIZER SWITCH  
P.C. BOARD (ND-5042)



**POWER SUPPLY P.C. BOARD  
(ND-2010) BLOCK**

Symbol No.	Parts No.	Description	Q'ty
12-1x	BA536321	Power Supply P.C. Board Comp. (ND-2010)	1
12-2	EZ480396	Heat-sink Plate	1
12-TR1	ET391735	Transistor 2SC1013(D) (E)	1
12-3	ZW413155	Screw, binding head 3x6	3
12-4x	MZ528805	Heat-sink Retaining Plate	1
12-5	ZW417137	Screw, binding head 3x4	3
12-D1	ED511918	Zener Diode WZ-240	1
12-D2 to 5	ED494583	Silicon Diode 10D05	4
12-D6	ED224526	Silicon Diode 10D1	1
12-D7, 8	ED224550	Silicon Diode 10D4	2
12-6x	MZ529110	P.C. Board Retaining Plate C	1
		<b>Capacitor, Vertical Type</b>	
12-C1	EC336115	Elect. 220 $\mu$ F 25WV	1
12-C2	EC372148	Elect. 220 $\mu$ F 35WV	1
12-C3, 4	EC444082	Elect. 470 $\mu$ F 35WV	2
		<b>Resistor, Stopper Type</b>	
12-R1	ER430018	Carbon RD1/4 1(J)	1
12-R2	ER211667	Carbon RD1/4 100(J)	1
12-R3	ER306843	Carbon RD1/4 1.2k(J)	1

**EQUALIZER SWITCH P.C. BOARD  
(ND-5042) BLOCK**

Symbol No.	Parts No.	Description	Q'ty
13-1x	BS536400	Equalizer Switch P.C. Board Comp. (ND-5042)	1
13-SW1	ES520672	Slide Switch SL-282B4	1
13-SW2	ES520705	Push Switch UEG-22A	1
13-L1	EO524856	Ferri Inductor FL7H 820 $\mu$ H(J)	2
13-L2	EO380564	Ferri Inductor FL7H 1.8MH(J)	2
13-2	EZ528232	Switch Bracket A	1
13-3x	ZW442585	Screw, binding head 2.6x4	2
13-4x	VM422381	Slide Plate Shaft	2
13-5	EZ528210	Link B	1
13-6	ZW357164	'E' Ring 2.3M	2
		<b>Capacitor, Vertical Type</b>	
13-C1	EC368335	Mylar 0.022 $\mu$ F(J) 50WV	2
13-C2	EC379192	Mylar 0.039 $\mu$ F(J) 50WV	2
13-C3	EC311793	Mylar 0.012 $\mu$ F(J) 50WV	2
13-C4	EC389485	Mylar 0.018 $\mu$ F(J) 50WV	2
13-R1, 2	ER380913	Carbon Resistor RD1/4 33(J) (Stop. type)	4

FIG. 14 PHOTO OF SYS. CON. P.C. BOARD (ND-1048)

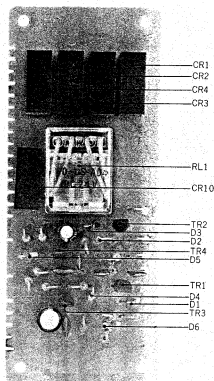

**SYS. CON. P.C. BOARD (ND-1048) BLOCK**

Symbol No.	Parts No.	Description	Q'ty
14-1x	BA536343	Sys. Con. P.C. Board Comp. (ND-1048)	1
14-2x	BA561172	Sys. Con. P.C. Board Comp. (ND-1048) (CSA, EC)	1
14-TR1 to 4	ET379462	Transistor 2SC711 (D) (E)	4
14-D1	ED514721	Silicon Diode WG-599	1
14-D2	ED219464	Germanium Diode 1N34A	1
14-D3 to 6	ED514721	Silicon Diode WG-599	4
14-CR1 to 4	ER226798	Spark Quencher 0.1 $\mu$ +120 $\Omega$ 250WV	4
14-CR10	ER376413	Spark Quencher U/L 0.033 $\mu$ +120 $\Omega$ 500WV	1
14-3x	EZ529536	P.C. Board Mt. Plate A	1
14-4x	EZ529547	P.C. Board Mt. Plate B	1
14-5x	ZW413223	Screw, binding head 3x5, w/washer	4
14-FR1	ER561216	Fuse Resistor FRN 1/4 100(K) 50MA (CSA, EC)	1
14-RL1	EP344136	Relay MY4-O-US-AD4-24V	1
<b>Capacitor, Vertical Type</b>			
14-C1	EC220994	Elect. 10 $\mu$ F 25WV	1
14-C2	EC250918	Mylar 0.01 $\mu$ F(M) 50WV	1
14-C3	EC391498	Mylar 0.022 $\mu$ F(M) 50WV	1
14-C4	EC250918	Mylar 0.01 $\mu$ F(M) 50WV	1
14-C5	EC350684	Elect. 22 $\mu$ F 25WV	1
14-C6	EC391498	Mylar 0.022 $\mu$ F(M) 50WV	1
14-C7, 8	EC250918	Mylar 0.01 $\mu$ F(M) 50WV	2
<b>Resistor, Stopper Type</b>			
14-R1	ER211667	Carbon RD1/4 100(J)	1
14-R2	ER336442	Carbon RD1/4 10k(J)	1
14-R3	ER212883	Carbon RD1/4 4.7k(J)	1
14-R4	ER212477	Carbon RD1/4 3.3k(J)	1
14-R5 to 7	ER212883	Carbon RD1/4 4.7k(J)	3
14-R8	ER336442	Carbon RD1/4 10k(J)	1
14-R9	ER357456	Carbon RD1/4 2.2k(J)	1
14-R10	ER211757	Carbon RD1/4 100k(J)	1
14-R11	ER212264	Carbon RD1/4 22k(J)	1
14-R12	ER212883	Carbon RD1/4 4.7k(J)	1
14-R13	ER212264	Carbon RD1/4 22k(J)	1
14-R14	ER357456	Carbon RD1/4 2.2k(J)	1

When ordering parts, please describe Parts Number, Serial Number, and Model Number in detail.

FIG. 15 PHOTO OF REC. AMP. P.C. BOARD (ND-5038)

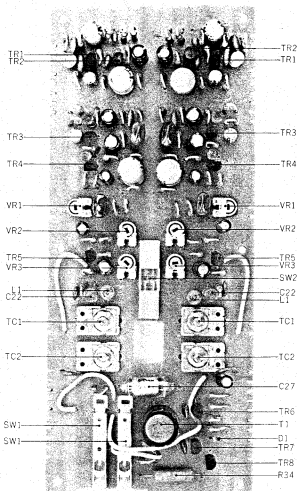

REC. AMP. P.C. BOARD (ND-5038) BLOCK

Symbol No.	Parts No.	Description	Q'ty
15-1x	BA536433	Rec. Amp. P.C. Board Comp. (ND-5038)	1
15-TR1 to 4	ET517263	Transistor 2SC1312(G) (H)	8
15-TR5 to 8	ET453486	Transistor 2SC711(E) (F)	5
15-D1	ED514721	Silicon Diode WG-599	2
15-VR1	EV464207	Semi-fixed Volume V8K4-1 5k $\Omega$	2
15-VR2, 3	EV520806	Semi-fixed Volume V8K4-1 10 k $\Omega$	4
15-TC1, 2	EC398878	Trimmer/C. C-1P-2 50 to 70PF	4
15-L1	EO321254	Ferr Inductor FL7H 5.6MH(J)	2
15-SW1	ES520784	Slide Switch CL-104B0	2
15-SW2	ES520795	Slide Switch CL-204E	2
15-T1	EO383365	OSC. Coil OT-204	1

Symbol No.	Parts No.	Description	Q'ty
<b>Capacitor, Vertical Type</b>			
15-C1	EC290520	VFM 100PF(J) 50WV	2
15-C2	EC336126	Elect. 47 $\mu$ F 25WV	2
15-C3	EC432810	Elect. 10 $\mu$ F 16WV(NL)	2
15-C4	EC290520	VFM 100PF(J) 50WV	2
15-C5	EC336104	Elect. 100 $\mu$ F 6.3WV	2
15-C6	EC456322	VFM 22PF(K) 50WV	2
15-C7	EC394918	VFM 33PF(K) 50WV	2
15-C8	EC320051	Elect. 10 $\mu$ F 16WV	2
15-C9	EC329771	Elect. 47 $\mu$ F 6.3WV	2
15-C10	EC320051	Elect. 10 $\mu$ F 16WV	2
15-C11	EC357827	VFM 50PF(K) 50WV	2
15-C12	EC329771	Elect. 47 $\mu$ F 6.3WV	2
15-C13	EC357827	VFM 50PF(K) 50WV	2
15-C14	EC290520	VFM 100PF(J) 50WV	2
15-C15	EC333562	Mylar 0.18 $\mu$ F(K) 50WV	2
15-C16	EC329771	Elect. 47 $\mu$ F 6.3WV	2
15-C17	EC320051	Elect. 10 $\mu$ F 16WV	2
15-C18	EC336126	Elect. 47 $\mu$ F 25WV	2
15-C19	EC333562	Mylar 0.18 $\mu$ F(K) 50WV	2
15-C20	EC320051	Elect. 10 $\mu$ F 16WV	2
15-C21	EC220994	Elect. 10 $\mu$ F 25WV	2
15-C22	EC405898	Styrol 470PF(J) 50WV	2
15-C23, 24, 25	EC520841	Mylar 0.01 $\mu$ F(J) 50WV	4
15-C26	EC450055	Elect. 1 $\mu$ F 25WV	1
15-C27	EC520773	Styrol 2000PF(J) 250WV (Tub. type)	1
15-C28	EC250885	Mylar 0.01 $\mu$ F(K) 50WV	1
<b>Resistor, Stopper Type</b>			
15-R1	ER336442	Carbon RD1/4 10k(J)	2
15-R2	ER362485	Carbon RD1/4 330k(J)	2
15-R3	ER336442	Carbon RD1/4 10k(J)	2
15-R4	ER213300	Carbon RD1/4 680(J)	2
15-R5	ER346994	Carbon RD1/4 18k(J)	2
15-R6	ER343078	Carbon RD1/4 2.7k(J)	2
15-R7	ER357570	Carbon RD1/4 150k(J)	2
15-R8	ER343135	Carbon RD1/4 1.6k(J)	2
15-R9	ER407316	Carbon RD1/4 24k(J)	2
15-R10	ER357456	Carbon RD1/4 2.2k(J)	2
15-R11, 12	ER346601	Carbon RD1/4 47k(J)	4
15-R13	ER357412	Carbon RD1/4 220(J)	2
15-R14	ER450011	Carbon RD1/4 120k(J)	2
15-R15	ER349942	Carbon RD1/4 8.2k(J)	2
15-R16	ER347038	Carbon RD1/4 270 (J)	2
15-R17	ER357491	Carbon RD1/4 82k(J)	2
15-R18	ER212264	Carbon RD1/4 22k(J)	2
15-R19	ER420322	Carbon RD1/4 36k(J)	2
15-R20	ER343078	Carbon RD1/4 2.7k(J)	2
15-R21	ER362441	Carbon RD1/4 1.8k(J)	2
15-R22	ER213377	Carbon RD1/4 750(J)	2
15-R23	ER342933	Carbon RD1/4 27k(J)	2
15-R24	ER357456	Carbon RD1/4 2.2k(J)	2
15-R25	ER342933	Carbon RD1/4 27k(J)	2
15-R26	ER336442	Carbon RD1/4 10k(J)	2
15-R27	ER211465	Carbon RD1/4 1k(J)	2
15-R28	ER349784	Carbon RD1/4 390(J)	2
15-R29	ER336442	Carbon RD1/4 10k(J)	2
15-R30 31	ER315944	Carbon RD1/4 3.3(J)	2
15-R32	ER304402	Carbon RD1/4 470(J)	1
15-R33	ER212883	Carbon RD1/4 4.7k(J)	1
15-R34	ER511288	Metal Oxide Film 1W 180(K)	1
15-R35	ER211465	Carbon Oxide Film 1k(J)	1
15-R36	ER371946	Carbon RD1/4 2k(J)	1

When ordering parts, please describe Parts Number, Serial Number, and Model Number in detail.



FIG. 16 PHOTO OF P.B. AMP. P.C. BOARD (ND-5037)

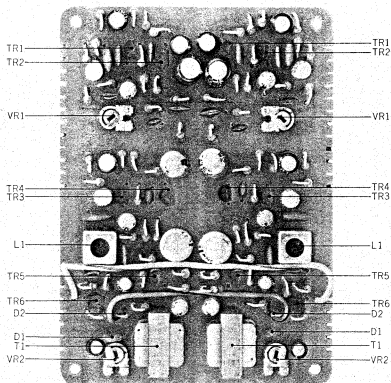

P.B. AMP. P.C. BOARD (ND-5037) BLOCK

Symbol No.	Parts No.	Description	Q'ty	Symbol No.	Parts No.	Description	Q'ty
16-1X	BA536422	P.B. Amp. P.C. Board Comp. (ND-5037)	1	16-C23	EC450055	Elect. 1 $\mu$ F 25WV	2
16-TR1, 2, 3	ET517263	Transistor 2SC1312(G) (H)	6	<b>Resistor, Stopper Type</b>			
16-TR4, 5, 6	ET379462	Transistor 2SC711(D) (E)	6	16-R1	ER362485	Carbon RD1/4 330k(J)	2
16-D1	ED219464	Germanium Diode 1N34A	2	16-R2	ER346601	Carbon RD1/4 47k(J)	2
16-D2	ED520762	Zener Diode YZ-088A	2	16-R3	ER362485	Carbon RD1/4 330k(J)	2
16-L1	EO346230	Inductor RX22MH	2	16-R4	ER336442	Carbon RD1/4 10k(J)	2
16-T1	BT247768	Head Phone Trans. N19-5921S	2	16-R5	ER212681	Carbon RD1/4 330(J)	2
16-VR1	EV464220	Semi-fixed Volume V8K4-1 50 k $\Omega$	2	16-R6	ER357570	Carbon RD1/4 150k(J)	2
16-VR2	EV464207	Semi-fixed Volume V8K4-1 5 k $\Omega$	2	16-R7	ER212264	Carbon RD1/4 22k(J)	2
<b>Capacitor, Vertical Type</b>				16-R8	ER212872	Carbon RD1/4 3.3k(J)	2
16-C1	EC320040	Elect. 47 $\mu$ F 16WV	2	16-R9	ER212477	Carbon RD1/4 3.3k(J)	2
16-C2	EC432810	Elect. 10 $\mu$ F 16WV(NL)	2	16-R10	ER211757	Carbon RD1/4 100k(J)	2
16-C3	EC290520	VFM 100PF(J) 50WV	2	16-R11	ER352045	Carbon RD1/4 3.9k(J)	2
16-C4	EC467133	MYLAR 68PF(J) 50WV	2	16-R12	ER212477	Carbon RD1/4 3.3k(J)	2
16-C5	EC329771	Elect. 47 $\mu$ F 6.3WV	2	16-R13	ER346601	Carbon RD1/4 47k(J)	2
16-C6	EC290520	VFM 100PF(J) 50WV	2	16-R14	ER346994	Carbon RD1/4 18k(J)	2
16-C7	EC517138	Elect. 10 $\mu$ F 25WV(NL)	2	16-R15	ER212883	Carbon RD1/4 4.7k(J)	2
16-C8	EC329771	Elect. 47 $\mu$ F 6.3WV	2	16-R16	ER346601	Carbon RD1/4 47k(J)	2
16-C9	EC389485	MYLAR 0.018 $\mu$ F(J) 50WV	2	16-R17	FR211465	Carbon RD1/4 1k(J)	2
16-C10	EC250683	MYLAR 0.0022 $\mu$ F(J) 50WV	2	16-R18	ER357456	Carbon RD1/4 2.2k(J)	2
16-C11	EC389474	MYLAR 0.0015 $\mu$ F(J) 50WV	2	16-R19	ER212681	Carbon RD1/4 330(J)	2
16-C12	EC336126	Elect. 47 $\mu$ F 25WV	2	16-R20	ER357491	Carbon RD1/4 82k(J)	2
16-C13	EC432810	Elect. 10 $\mu$ F 16WV(NL)	2	16-R21	ER357456	Carbon RD1/4 2.2k(J)	2
16-C14	EC329850	VFM 200PF(J) 50WV	2	16-R22	ER212681	Carbon RD1/4 330(J)	2
16-C15	EC329771	Elect. 47 $\mu$ F 6.3WV	2	16-R23	ER357412	Carbon RD1/4 220(J)	2
16-C16	EC290520	VFM 100PF(J) 50WV	2	16-R24	ER212264	Carbon RD1/4 22k(J)	2
16-C17	EC399565	VFM 22PF(J) 50WV	2	16-R25	ER211465	Carbon RD1/4 1k(J)	2
16-C18	EC336104	Elect. 100 $\mu$ F 6.3WV	2	16-R26	ER212264	Carbon RD1/4 22k(J)	2
16-C19	EC320051	Elect. 100F 16WV	2	16-R27	ER211757	Carbon RD1/4 100k(J)	2
16-C20	EC389474	MYLAR 0.0015 $\mu$ F(J) 50WV	2	16-R28	ER350100	Carbon RD1/4 68k(J)	2
16-C21	EC450055	Elect. 1 $\mu$ F 25WV	2	16-R29	ER212883	Carbon RD1/4 4.7k(J)	2
16-C22	EC320051	Elect. 10 $\mu$ F 16WV	2	16-R30	ER211465	Carbon RD1/4 1k(J)	2
				16-R31	ER429996	Carbon RD1/4 470k(J)	2

When ordering parts, please describe Parts Number, Serial Number, and Model Number in detail.

FIG. 17 PHOTO OF FINAL ASSEMBLY BLOCK

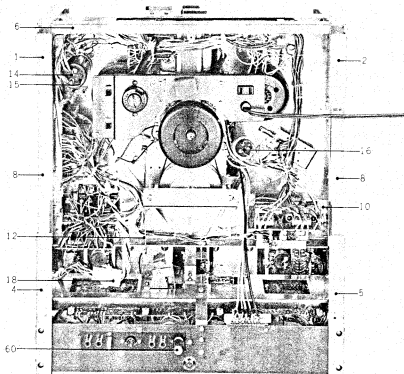
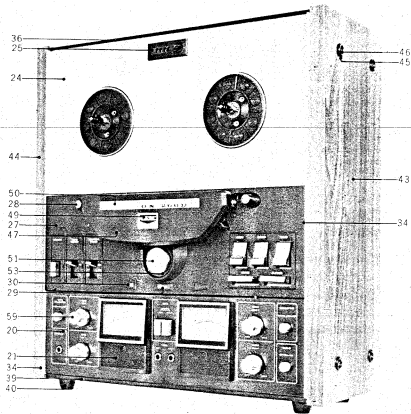

## FINAL ASSEMBLY BLOCK

Ref. No.	Parts No.	Description	Schematic No.	Qty
17-1	MZ528985	Mech. Side Plate A (Right)	ND-6001	1
17-2	MZ528996	Mech. Side Plate B (Left)	ND-6001	1
17-3x	ZW462925	Tapping Screw #2 4x8(BR)		4
17-4	MZ529931	Mech. Side Plate C (Right)	ND-6002	1
17-5	MZ529942	Mech. Side Plate D (Left)	ND-6002	1
17-6	SZ529920	Reinforcement Angle A	ND-6003	1
17-7x	ZW447772	Tapping Screw #2 3x6(BR)		16
17-8	SZ529086	Reinforcement Angle B	ND-6004	2
17-9x	ZW416687	Screw, binding head 4x8		8
17-10	SZ529007	Nut Plate	ND-6015	2
17-11x	ZW424620	Screw, pan head 3x10		4
17-12	SZ528412	Reverse Switch Rod	ND-5034	1
17-13x	ZW290283	'U' Ring 2.85M	6-1-1	1
17-14	EC520547	Elect./C. 330 $\mu$ F 200WV (Lug type)	24-10-75	1
17-15	ER365016	Carbon/R. RD1/4 220k(J) (Insu. type)	35-9-5	1
17-16	EC314662	MP/C. 2+1 $\mu$ F 250WVAC (Lug type Uni/D.)	24-9-34	1
17-17x	EC536938	MP/C. 2 $\mu$ F 250WVAC (Lug type Uni/D.) (UL, CSA)	24-9-78	1
17-18	EJ299834	6P Mate-N-Lock Plug Housing 1-480273-0	52-1-2	1
17-19x	EJ373634	Socket Contact 61115-1	52-1-1	1
17-20	SP529042	Amp. Panel	ND-6009	1
17-21	SC473815	VU Meter Cover	KH-6020	2
17-22x	ZW487866	Screw, round head 2.6x6		6
17-23x	ZW447772	Tapping Screw #2 3x6(BR)		7
17-24	SP529953	Mech. Panel Comp.	ND-6007	1
17-25	SZ528906	Counter Escutcheon	ND-6008	1
17-26x	ZW323728	Screw, binding head 3x5		4
17-27	SP529031	Front Panel	ND-6010	1
17-28	SE528390	Column Cover	ND-6011	2
17-29	SE528401	Rec. Lamp Lens	ND-6012	1
17-30	SE528974	Direction Indicator Lamp Lens	ND-6013	2
17-31x	SE528816	Mask, Pinch Wheel	ND-6027	1
17-32x	ZW200687	Tapping Screw #2 3x6 (round)		2
17-33x	SZ529874	Head Cover Prop	ND-6014	2
17-34	SE529020	Sash	ND-6006	2
17-35x	ZW417352	Screw, pan head 3x6		8
17-36	SP528748	Upper Plate	ND-6022	1
17-37x	ZW462172	Decorative Washer M3		4
17-38x	ZW482815	Screw, oval countersunk head 3x8		4
17-39	SP528750	Bottom Plate	ND-6022	1
17-40	SZ377190	LM Rubber Foot	LM-404	8
17-41x	ZW419646	Washer (SPC)D4.5x9.8x0.5t		8
17-42x	ZW487776	Screw, truss head 4x18		8
17-43	SZ527692	Side Plate A (Right)	ND-6021	1
17-44	SZ527703	Side Plate B (Left)	ND-6021	1
17-45	ZW513764	Spot Facing Washer	2-4-28	8
17-46	ZW520525	Screw, binding head 4x25		8
17-47	SC529018	Head Cover	ND-6016	1
17-48x	SZ527670	Head Cover Retaining Ring	ND-6018	2
17-49	SZ382285	GX Symbol Plate	RD-A633	1
17-50	SM529468	Name Plate GX-260D	ND-6017	1
17-51	SK529773	Pinch Roller Cap	ND-6028	1
17-52x	SZ527681	Pinch Roller Set Screw	ND-6019	1
17-53	MP275984	RD Pinch Roller	RD-231	1
17-54x	SP529402	Back Plate	ND-6023	1
17-55x	SP530076	Back Plate (UL)	ND-6023	1
17-56x	SP530054	Back Plate (CSA)	ND-6023	1
17-57x	SP530065	Back Plate (CEE)	ND-6023	1
17-58x	ZW494842	Tapping Screw #2 3x8 (bind), w/washer		2
17-59	SK475154	Amp. Knob	LF-6206	4
17-60	SK409511	Amp. Knob D Comp.	LF-6025	1
17-61x	EF277413	Fuse ST-2 1A	30-1-26	1
17-62x	EF304626	Fuse ST-4 1A	30-1-28	2

When ordering parts, please describe Parts Number, Serial Number, and Model Number in detail.

# INDEX

Parts No.	Ref. No. & Symbol No.	Parts No.	Ref. No. & Symbol No.	Parts No.	Ref. No. & Symbol No.	Parts No.	Ref. No. & Symbol No.	Parts No.	Ref. No. & Symbol No.
BA527376	7-17	EC329771	16-C8	EL527567	6-16	ER357456	14-R9	EZ528208	9-35
BA536286	5-42	EC329771	16-C15	EM520694	9-22	ER357456	14-R10	EZ528210	9-13
BA536286	10-1x	EC329850	16-C14	EM561756	9-23x	ER357456	15-R14	EZ528210	13-5
BA536308	6-18	EC333562	15-C15	EO321254	15-L1	ER357456	15-R24	EZ528232	9-10
BA536308	11-1x	EC333562	15-C19	EO346230	16-11	ER357456	16-R18	EZ528232	13-2
BA536321	7-26	EC336104	15-C5	EO346500	15-50x	ER357456	16-R21	EZ528243	9-29
BA536321	12-1x	EC336104	16-C18	EO380564	13-L2	ER357491	15-R17	EZ528265	9-15
BA536343	14-1x	EC336115	12-C1	EO383365	15-T1	ER357491	16-R20	EZ528276	9-63
BA536422	16-1x	EC336126	15-C2	EO524856	13-L1	ER357570	15-R7	EZ528298	9-37
BA536433	15-1x	EC336126	15-C18	EP344136	14-RL1	ER357570	16-R6	EZ528300	9-42x
BA561172	14-2x	EC336126	16-C12	EP520558	8-66	ER362441	15-R21	EZ528322	9-40
BC529492	4-2	EC350684	14-C5	EP520558	8-81	ER362448	15-R2	EZ528333	9-34
BF536264	1-1x	EC350987	11-C5, 6	EP554747	8-30	ER362485	16-R1	EZ528344	5-28
BH536354	4-1x	EC357827	15-C11	ER211465	15-R27	ER362485	16-R3	EZ528344	8-137x
BK536398	9-6x	EC357827	15-C13	ER211465	15-R35	ER365016	16-R14	EZ528344	8-151
BK536398	9-33x	EC368335	13-C1	ER211465	16-R17	ER365016	17-15	EZ528366	9-75
BM314741	3-1	EC372148	12-C2	ER211465	16-R25	ER371946	15-R36	EZ528377	9-58
BMS36253	2-1x	EC379197	13-C2	ER211465	16-R20	ER376413	14-C10	EZ528467	9-43
BP536310	7-1x	EC389474	16-C11	ER211667	12-R2	ER380913	13-R1, 2	EZ528682	9-75
BP536747	7-2x	EC389474	16-C20	ER211667	14-R1	ER407316	15-R9	EZ528930	9-38
BP536758	7-3x	EC389485	13-C4	ER211757	14-R10	ER420322	15-R19	EZ528952	9-86
BP536995	7-4x	EC389485	16-C9	ER211757	16-R10	ER420996	16-R31	EZ528963	9-85
BP561161	7-5x	EC391498	14-C3	ER211757	16-R27	ER430018	12-R1	EZ529121	7-43
BR482400	3-2x	EC391498	14-C6	ER212264	10-R5	ER450011	15-R14	EZ529413	7-37
BR482411	3-1x	EC394918	15-C7	ER212264	14-R11	ER465750	7-18	EZ529536	14-3x
BSS36297	6-1x	EC398878	15-TC1, 2	ER212264	14-R13	ER511288	15-R34	EZ529547	14-4x
BS536400	9-8	EC399565	16-C17	ER212264	15-R18	ES520648	7-20	EZ529560	9-61
BS536400	13-1x	EC405898	15-C22	ER212264	16-R7	ES520740	9-54x	EZ529593	9-48
BT247668	16-T1	EC432810	15-C3	ER212264	16-R24	ER550574	7-21	EZ529604	9-5
BT520615	7-8	EC432810	16-C2	ER212264	16-R26	ER550585	7-19	EZ529661	9-2
BZ536951	7-9x	EC432810	16-C13	ER212477	14-R4	ER552813	7-23x	EZ530021	9-83
BT561205	7-11x	EC440052	12-C3, 4	ER212477	16-R9	ER552813	8-162x	EZ546614	7-38x
BZ527387	9-49	EC450055	15-C26	ER212477	16-R12	ES561216	14-FR1	HL527433	1-52
BZ536375	5-1x	EC450055	16-C21	ER212681	16-R5	ES500616	5-40	HL527444	1-21
BZ536382	7-32x	EC450055	16-C23	ER212681	16-R19	ES520064	8-106	HL528074	1-23
BZ536387	9-1x	EC456322	15-C6	ER212681	16-R22	ES379045	9-50x	HL528085	1-18
BZ536411	9-47x	EC467133	16-C4	ER212872	16-R8	ES389700	8-150	HL528096	1-19
BZ536736	7-35x	EC517138	16-C7	ER212883	14-R3	ES403727	5-39	HP560698	1-31
BZ536760	7-33x	EC520547	8-140x	ER212883	14-R5 to 7	ES403727	8-37	HP560700	1-32x
		EC520547	17-14	ER212883	14-R12	ES438535	8-90	HP560711	1-33x
BZ536771	7-34x	EC520626	7-14	ER212883	15-R33	ES449796	6-10	HP560722	1-34x
BZ561183	7-36x	EC520773	15-C27	ER212883	16-R15	ES477966	5-29	HP560733	1-35x
EA382713	1-59x	EC536927	7-15x	ER212883	16-R29	ES479395	8-124	HR536615	1-43
EA463206	1-36x	EC536938	8-143x	ER213300	15-R4	ES479485	6-12	HZ317632	8-119
EA480925	7-52x	EC536938	17-17x	ER213377	15-R22	ES479485	7-44	HZ425485	8-121
EA527523	1-49	EC559260	7-42x	ER213715	6-15x	ES494188	8-133x	HZ527422	1-53
EA527624	8-111	ED219464	14-D2	ER213794	9-52x	ES494594	8-106	HZ527466	1-27
EA527668	6-14	ED219464	16-D1	ER226798	8-130x	ES520604	5-35	HZ527490	1-41
EA528254	9-30	ED224556	12-D6	ER226798	10-CR to 10-9	ES520672	4-48	HZ527501	1-28
EA546570	8-131x	ED224556	12-D7, 8	ER226798	14-CR1 to 4	ES520672	9-9	HZ527512	1-37
EC220994	14-C1	ED224561	8-31x	ER304402	15-R32	ES520672	13-SW1	HZ527602	1-2
EC220994	15-C21	ED224561	8-67x	ER306843	12-R3	ES520705	9-11	HZ527940	1-42
EC250683	16-C10	ED224561	8-82x	ER315944	15-R30, 31	ES520705	9-17	HZ527951	1-47
EC250841	15-C23, 24, 25	ED224561	8-122 to 5	ER329264	4-55x	ES520705	13-SW2	HZ528570	1-12
EC250885	15-C28	ED511918	12-D1	ER336442	14-R2	ES520784	15-SW1	HZ528581	1-1
EC250918	14-C2	ED514721	14-D1	ER336442	16-R8	ES520784	15-SW2	HZ528592	1-5
EC250918	14-C4	ED514721	14-D3 to 6	ER336442	15-R1	ES511994	8-118	HZ529288	1-51
EC250918	14-C7, 8	ED514721	15-D1	ER336442	15-R3	ET379462	14-TR1 to 4	HZ529328	1-10
EC273464	10-C2	ED520762	16-D2	ER336442	15-R26	ET379462	16-TR4, 5, 6	HZ529470	1-29
EC273464	11-C7 to 13	EF277413	7-48	ER336442	15-R29	ET391735	12-TR1	HZ529481	1-45
EC290520	15-C1	EF277413	17-61x	ER336442	16-R4	ET453486	15-TR5 to 8	HZ531584	1-56
EC290520	15-C4	EF304626	17-62x	ER342933	15-R23	ET517263	15-TR1 to 2, 4	MA453756	4-12
EC290520	15-C14	EF513663	7-57x	ER342933	16-R25	ET517263	16-TR1, 2, 3	MB229138	8-159x
EC290520	16-C3	EF524722	7-53x	ER343078	15-R8	EV464207	15-VR1	MB238768	4-23
EC290520	16-C6	EJ205986	8-160x	ER343078	15-R20	EV464207	16-VR2	MB314949	3-25
EC290520	16-C16	EJ233370	7-49	ER343135	15-R8	EV464220	16-VR1	MB314987	2-24
EC311793	13-C3	EJ292961	9-82	ER345712	9-53x	EV487822	9-4	MB527556	3-32
EC314662	8-142x	EJ299823	9-80x	ER346601	15-R11, 12	EW520738	9-51x	MB527556	8-147x
EC314662	17-16	EJ299834	8-154x	ER346601	16-R2	EW520806	15-VR2, 3	MC520536	8-145
EC320040	16-C1	EJ299834	17-18x	ER346601	16-R13	EW540112	7-41x	MC527635	8-103x
EC320051	15-C8	EJ373623	9-81x	ER346601	15-R5	EZ244124	4-9x	MH527905	8-10
EC320051	15-C10	EJ373634	8-155x	ER346994	15-R6	EZ246936	7-58x	MH527916	8-9
EC320051	15-C17	EJ373634	17-19x	ER346994	16-R14	EZ315448	7-59x	MH528063	1-6
EC320051	15-C20	EJ378944	7-39	ER347038	15-R16	EZ238320	6-92x	MH529233	1-8
EC320051	16-C19	EJ433844	9-25	ER349784	15-R28	EZ382263	7-40	MH529312	8-2
EC320051	16-C22	EJ442078	9-29	ER349942	15-R15	EZ480396	7-27	MI455747	4-3
EC329771	15-C12	EJ364940	7-51x	ER350100	16-R28	EZ480396	7-28	ML314976	3-23
EC329771	15-C12	EJ546636	7-56x	ER352045	16-R11	EZ496686	8-152x	ML314976	8-22
EC329771	15-C16	EL295312	8-112x	ER352045	15-R13	EZ516464	7-31x	ML396810	3-24x
EC329771	16-C5	EL295312	9-31x	ER357412	16-R23	EZ527850	7-46	ML396810	8-23

# INDEX

Parts No.	Ref. No. & Symbol No.	Parts No.	Ref. No. & Symbol No.	Parts No.	Ref. No. & Symbol No.	Parts No.	Ref. No. & Symbol No.
MLS27613	8-126	MZ317406	3-31	SZ527681	8-163	ZW273881	1-17
MLS27646	8-75	MZ317406	8-156	SZ527681	17-52x	ZW273881	4-11x
MLS27747	5-7	MZ397181	8-18	SZ527703	17-43	ZW273881	7-62x
MLS27758	5-6	MZ402377	5-41	SZ527703	17-44	ZW274026	8-49x
MLS27760	5-13	MZ438004	4-6	SZ528221	9-89	ZW290283	3-29
MLS27771	5-12	MZ448222	2-3	SZ528412	8-88	ZW290283	8-19
MLS27782	5-25	MZ453767	4-16	SZ528412	17-12	ZW290283	8-77
MLS27837	8-15	MZ479834	8-38	SZ528838	8-164	ZW290283	8-117
MLS27861	8-135x	MZ526421	2-2	SZ528840	8-165x	ZW290283	17-13x
MLS27861	8-152	MZ527545	7-60	SZ528906	17-25	ZW304806	1-57
MLS27962	8-110	MZ527578	8-68	SZ529007	17-10	ZW317171	9-72
MLS27973	6-2	MZ527657	8-88	SZ529086	17-8	ZW323728	1-24
MLS27984	8-92	MZ527815	7-6	SZ529108	2-11	ZW323728	3-28x
MLS28131	8-32	MZ527826	7-30	SZ529874	17-33x	ZW323728	4-22
MLS28131	8-83	MZ527848	8-52	SZ529920	17-6	ZW323728	5-27
MLS28142	6-3	MZ527883	8-89	VM423381	9-12	ZW323728	8-21
MLS28153	8-101	MZ527894	8-148	VM423381	13-4x	ZW323728	8-73
MLS28186	5-3	MZ527927	8-166	ZG232121	1-16	ZW323728	8-139
MLS28434	9-76	MZ528107	8-4	ZG255633	3-7	ZW323728	17-26x
MLS28445	8-47	MZ528164	7-22	ZG290878	9-24x	ZW325495	9-36
MLS28478	8-115	MZ528175	5-2	ZG317496	3-15	ZW330412	4-18x
MLS28513	8-102	MZ528557	8-62	ZG364656	1-46	ZW330412	8-44x
MLS28546	8-122	MZ528805	7-28	ZG465478	8-29	ZW330423	4-19x
MLS28794	8-118	MZ528805	12-4x	ZG466312	1-39	ZW330423	8-4-x
MLS28851	9-64	MZ528827	2-6	ZG520716	9-46	ZW330445	8-46x
MLS28873	9-65	MZ528985	17-1	ZG527477	1-25	ZW345442	8-64x
MLS28884	9-66	MZ528996	17-2	ZG527580	8-54	ZW345442	8-134x
MLS29132	6-4	MZ529097	2-7	ZG527938	8-78	ZW357164	9-14
MLS29198	5-33	MZ529110	7-29	ZG528041	1-55	ZW357164	13-6
MLS29200	5-34	MZ529110	12-6x	ZG528118	8-109	ZW365973	3-18
MLS29222	8-55	MZ529255	8-1	ZG528287	5-18	ZW371856	6-13
MLS29244	8-16	MZ529256	8-58	ZG528311	9-41x	ZW371856	8-33x
MLS29290	8-98	MZ529378	8-563	ZG528423	9-70	ZW371856	8-69x
MLS29323	8-79	MZ529558	8-94	ZG528917	5-14	ZW371856	8-128
MLS29345	8-108	MZ529648	8-70	ZG528928	5-15x	ZW372025	7-50
MLS29380	8-85	MZ529650	8-84	ZG529143	5-5	ZW373577	4-5
MLS29391	8-105	MZ529727	8-51	ZG529154	5-9	ZW379616	9-68
MLS29525	8-28	MZ529863	8-34	ZG529211	8-104	ZW391476	2-8
MLS29738	8-80	MZ529931	17-4	ZG529334	1-60	ZW396600	1-30
MLS29806	9-77	MZ529942	17-5	ZG529334	8-157	ZW396600	7-63
MLS29896	5-26	MZ540527	4-13	ZG529367	8-59	ZW396437	1-22
MLS30043	8-74	MZ546603	7-7x	ZG529424	6-6	ZW396437	8-76x
ML541484	9-67	MZ802980	8-60	ZG529435	6-5	ZW397146	8-40x
ML546557	8-127x	MZ810191	1-26	ZG529683	9-74	ZW403222	3-20
MP275984	8-161	SC473815	17-21	ZG529907	9-7	ZW413155	9-7
MP275984	17-53	SC529018	17-47	ZG540551	3-30	ZW413155	9-18
MR317507	3-17	SE527455	1-11	ZG540551	8-27	ZW413155	9-87x
MR529277	2-5	SE528390	17-28	ZW200687	17-32x	ZW413155	12-3
MS342000	3-6	SE528401	17-29	ZW200777	8-99	ZW413188	3-22x
MS397012	8-13	SE528816	17-31x	ZW257477	8-35	ZW413188	8-8x
MS645840	8-11	SE528974	17-30	ZW257477	8-71x	ZW413188	8-61
MS67400	8-14	SE529020	17-34	ZW257477	8-86	ZW413201	2-9
MS67411	5-16	SE529165	5-17	ZW259738	8-100x	ZW413201	2-10
MS67534	8-7	SE529176	5-31	ZW259986	5-20	ZW413223	8-113x
MS67591	8-48	SE529187	5-32	ZW260278	4-7	ZW413223	14-5x
MS67804	4-21	SE530392	5-23	ZW260368	9-27x	ZW413278	8-5x
MS68456	8-6	SE530403	5-24	ZW270088	3-9	ZW413278	8-50x
MS68480	8-6	SK409511	17-60	ZW270088	8-11	ZW413278	6-19x
MS68491	5-38	SK475154	17-59	ZW270088	8-36	ZW413785	9-80
MS69582	9-78	SK487675	9-32	ZW270088	8-63	ZW413785	1-15
MS69626	4-4	SK518477	8-129	ZW270088	8-87	ZW413785	8-95
MT255420	3-5	SK527736	5-8	ZW270088	9-73	ZW414066	8-43x
MT297663	3-8	SK528197	5-4	ZW270101	1-20	ZW416687	1-9x
MT436860	3-14	SK528603	6-9	ZW270101	8-22x	ZW416687	2-9
MT473422	3-10	SK528671	9-45	ZW270101	9-39x	ZW416687	4-10
MT473433	3-12	SK529773	17-51	ZW270101	9-79	ZW416687	17-9x
MT473444	3-11x	SK546581	8-132x	ZW270123	9-69	ZW417137	7-47
MT488147	3-4	SM529468	17-50	ZW270134	2-12	ZW417137	8-17
MV269965	4-15	SP528748	17-36	ZW270156	4-8	ZW417137	8-57
MV269965	6-8	SP528750	17-39	ZW270156	8-65	ZW417137	8-146
MZ250413	8-41	SP529031	17-27	ZW270191	9-28	ZW417137	12-5
MZ250413	8-91	SP529042	17-20	ZW272722	9-26x	ZW417148	8-42x
MZ250413	8-107	SP529402	17-54x	ZW273756	8-12x	ZW417148	8-93x
MZ314605	8-20	SP529953	17-24	ZW273756	8-97	ZW417328	8-138x
MZ314998	3-26	SP530054	17-56x	ZW273778	1-13	ZW417328	8-153x
MZ314998	8-25	SP530065	17-57x	ZW273778	13-8x	ZW417352	17-35x
MZ315000	2-27	SP530076	17-55x	ZW273778	5-37x	ZW417352	17-41x
MZ315000	8-26	SZ377190	17-40	ZW273778	6-17x	ZW419736	1-17
MZ317373	3-21	SZ382285	17-49	ZW273778	8-120	ZW419736	4-14
MZ317373	8-14	SZ527670	17-48x	ZW273778	9-56x	ZW419736	7-13x

GX-2600

HEAD BLOCK

NOTE  
UNLESS OTHERWISE SPECIFIED  
RESISTORS IN OHMS  
ALL CAPACITORS IN μF UNLESS  
OTHERWISE INDICATED  
W MARK INDICATES LOW LEAKAGE CAPACITOR

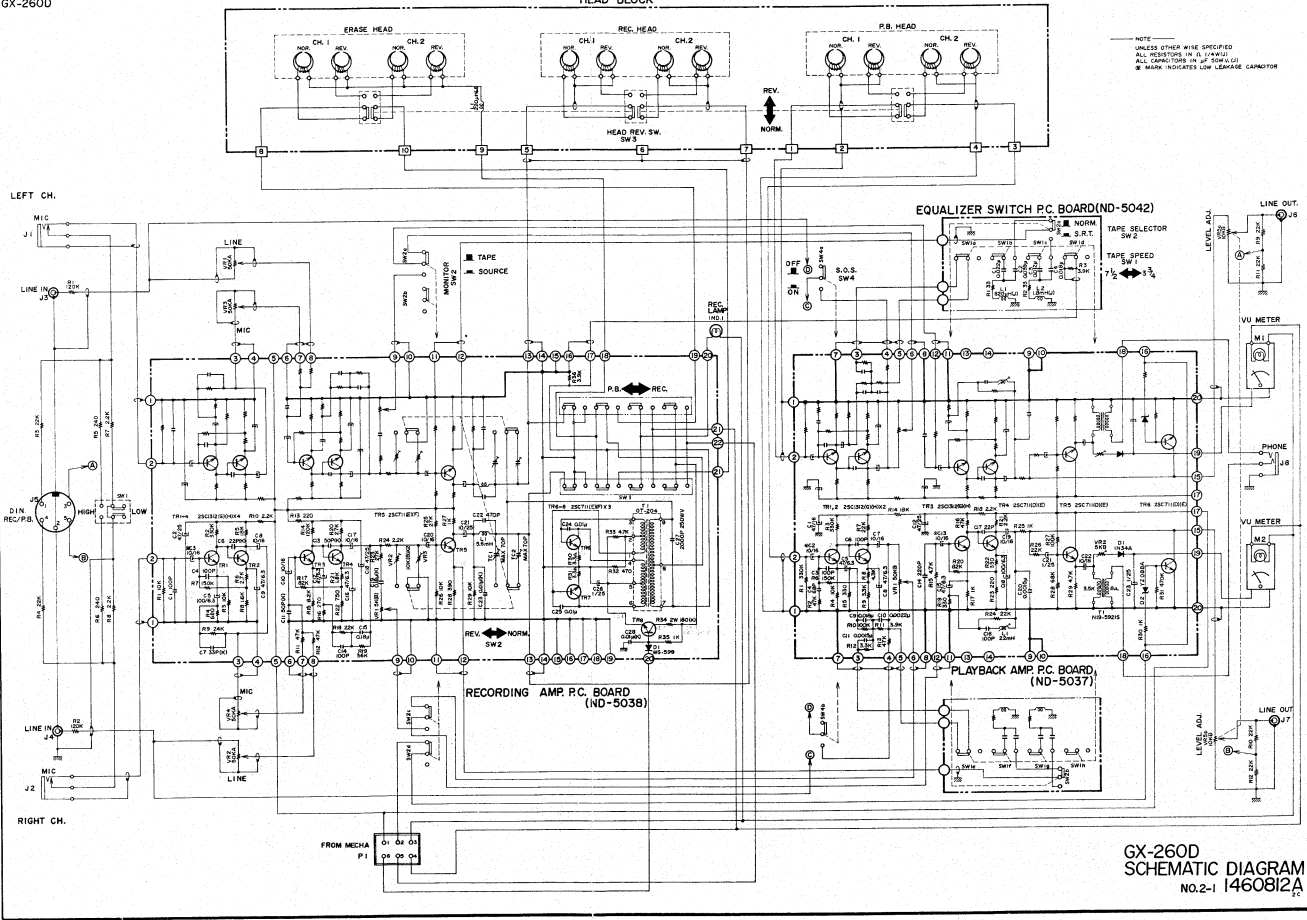

GX-2600  
SCHEMATIC DIAGRAM  
No.2-1 1460812A

GX-2600

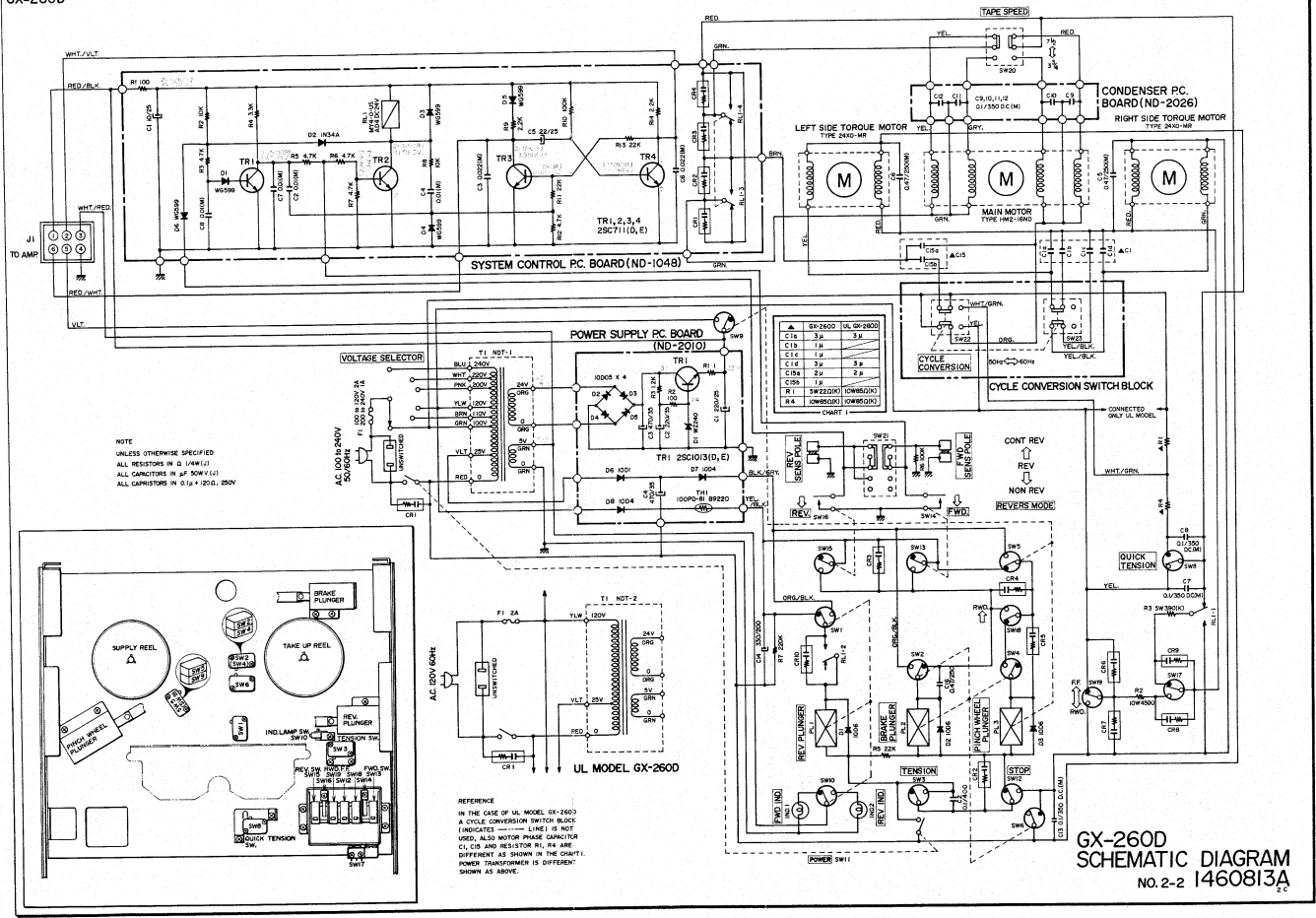

GX-2600  
 SCHEMATIC DIAGRAM  
 NO. 2-2 1460813A