

AKAI SERVICE MANUAL

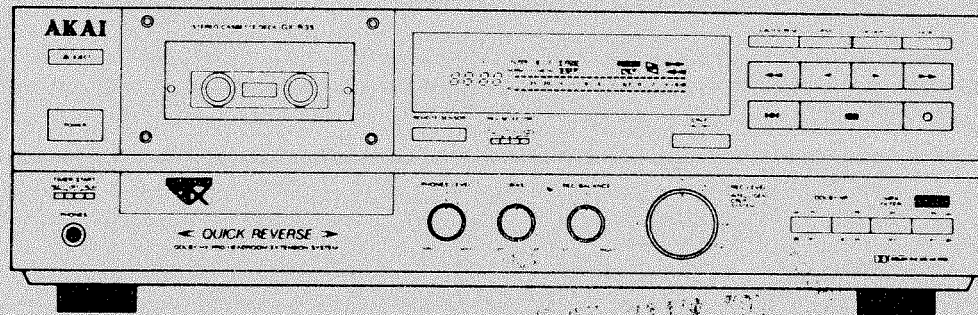

STEREO CASSETTE DECK

MODEL GX-R35

SPECIFICATIONS

Track system	4 track 2 channel stereo	Input sensitivity/Impedance	Line	70 mV/47 kohms
Heads	LC-OFC twin field SGX head for recording and playback × 1 Erase head × 1	CD/DAT direct in	240 mV/47 kohms	
Motors	Electronically controlled DC motor for capstan drive × 1 DC motor for reel drive × 1	Output level / Impedance	Line	388 mV/2 kohms
Wow and flutter	0.07 % DIN 0.045 % WRMS	Headphone	1.3 mW/8 ohms	
Tape winding time	80 sec. (C-60)	Power requirements	AC 220 V, 50 Hz for Europe except UK AC 110 V / 120 V / 220 V / 240 V, 50 / 60 Hz convertible for other countries	
Frequency response		Dimensions	425 (W) × 137 (H) × 353 (D) mm	
Normal	25 Hz to 17,000 Hz ± 3 dB	Weight	5.5 kg	
CrO ₂	25 Hz to 17,000 Hz ± 3 dB			
Metal	25 Hz to 18,000 Hz ± 3 dB			
S/N	56 dB (measured via metal tape with peak recording level) Dolby B type NR switch ON : Improves up to 5 dB at 1 kHz, 10 dB above 5 kHz. Dolby C type NR switch ON : Improves up to 15 dB at 500 Hz, 20 dB at 1 kHz to 10 kHz	Standard accessories	Connection RCA pin cord	×2
Total harmonic distortion	1.0 %		Remote control unit	×1
			R6 (AA) size Dry batteries	×2
			Operator's manual	×1

* For improvement purposes, specifications and design are subject to change without notice.

* Noise reduction manufactured under license from dolby laboratories licensing corporation.

"DOLBY" and  symbol are trademarks of dolby licensing corporation.

★ SAFETY INSTRUCTIONS

PRECAUTIONS DURING SERVICING

- Parts identified by the ⚠️ (*) symbol are critical for safety. Replace only with parts number specified.
- In addition to safety, other parts and assemblies are specified for conformance with such regulations as those applying to spurious radiation. These must also be replaced only with specified replacements.

Examples: RF converters, tuner units, antenna selector switches, RF cables, noise blocking capacitors, noise blocking filters, etc.

- Use specified internal wiring. Note especially:

- 1) Wires covered with PVC tubing
- 2) Double insulated wires
- 3) High voltage leads

4. Use specified insulating materials for hazardous live parts. Note especially:

- 1) Insulation Tape
- 2) PVC tubing
- 3) Spacers (Insulating Barriers)
- 4) Insulation sheets for transistors
- 5) Plastic screws for fixing microswitch (especially in turntable)

5. When replacing AC primary side components (transformers, power cords, noise blocking capacitors, etc.), wrap ends of wires securely about the terminals before soldering.

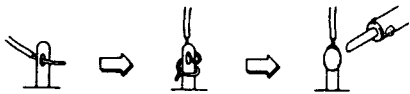

6. Observe that wires do not contact heat producing parts (heatsinks, oxide metal film resistors, fusible resistors, etc.).

7. Check that replaced wires do not contact sharp edged or pointed parts.
8. Also check areas surrounding repaired locations.
9. Use care that foreign objects (screws, solder droplets, etc.) do not remain inside the set.

SAFETY CHECK AFTER SERVICING

After servicing, make measurements of leakage-current or resistance in order to determine that exposed parts are acceptably insulated from the supply circuit.

The leakage-current measurement should be done between accessible metal parts (such as chassis, ground terminal, microphone jacks, signal-input/output connectors, etc.) and the earth ground through a resistor of 1500 ohms paralleled with a 0.15 μF capacitor, under the unit's normal working conditions. The leakage-current should be less than 0.5 mA rms AC.

The resistance measurement should be done between accessible exposed metal parts and power cord plug prongs with the power switch (if included) "ON". The resistance should be more than 2.2 Mohms.

MAKE YOUR CONTRIBUTION TO PROTECT THE ENVIRONMENT

Used batteries with the ISO symbol for recycling as well as small accumulators (rechargeable batteries), mini-batteries (cells) and starter batteries should not be thrown into the garbage can.



Please leave them at an appropriate depot. All other household batteries can be thrown out with the household waste.

★ INFORMATION

SYMBOLS FOR PRIMARY DESTINATION

Alphabet indicates the destination of the units as listed below.

Symbols	Principal Destinations
A	USA
B	UK
C	Canada
E	Europe (except UK)
J	Japan
S	Australia
Y	VK (COMMONWEALTH ONLY)
U	Universal Area
Y*	Custom version

VOLTAGE CONVERSION (U Model only)

Before connecting the power cord, set the VOLTAGE SELECTOR located on the rear panel with a flat type screwdriver so that the correct voltage for your area is indicated.

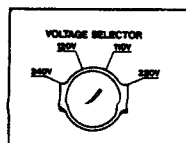

I. DISASSEMBLY

In case of trouble, etc., necessitating dismantling, please dismantle in the order shown in the illustrations. Reassemble in reverse order.

1. Removal of UPPER COVER

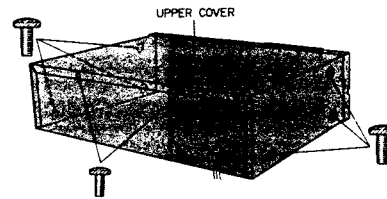

2. Removal of FRONT PANEL

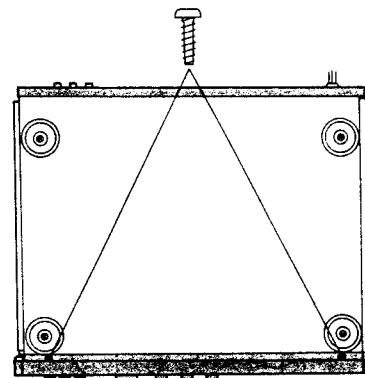

3.

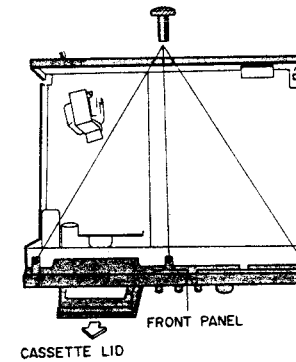

* Remove CASSETTE LID first, then remove FRONT PANEL next.

4. Removal of MECHA. BLOCK

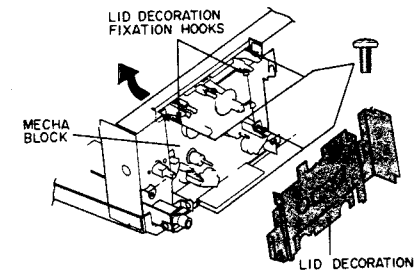

- 1) Remove LID DECORATION while releasing LID DECORATION FIXATION HOOKS.
- 2) Disconnect all the connectors which connected from the MECHA. BLOCK.
- 3) Move the MECHA. BLOCK down a little, then pull out the MECHA. BLOCK from rear side.

II. PRINCIPAL PARTS LOCATION

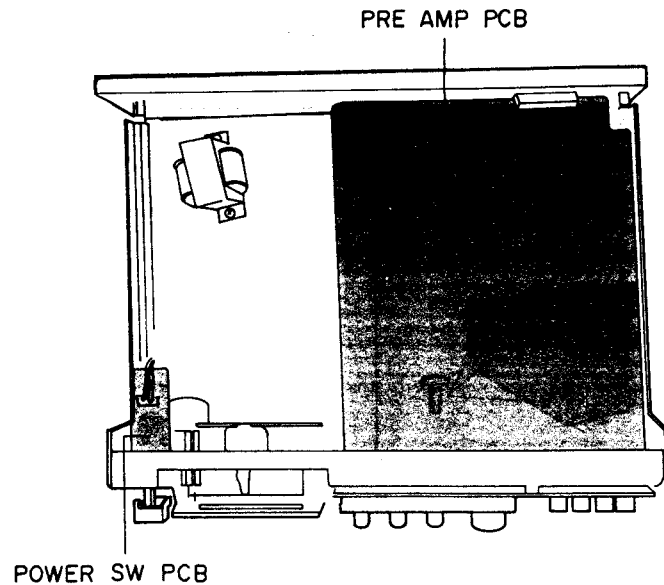

Fig. 2-1 Top view

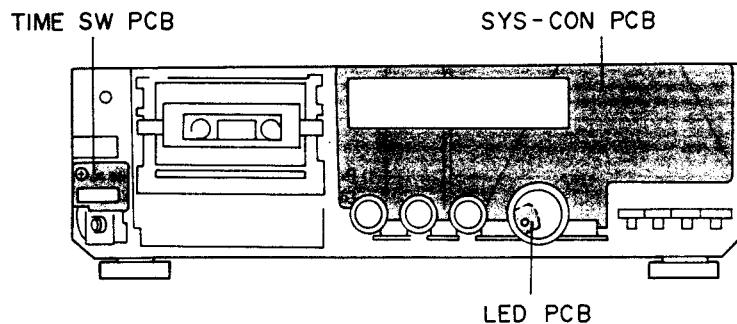

Fig. 2-2 Front view

III. REPLACEMENT OF PRINCIPAL MECHANICAL PARTS

3-1. DISASSEMBLE PROCEDURE OF PRINCIPAL MECHANICAL PARTS

* Please refer to "I. DISASSEMBLY" for removal of MECHA. BLOCK.



- PINCH ROLLER BLK
- HEAD BLK
- SEPARATION OF MECHA. BLK.
 - DRIVE BELT
 - CAPSTAN MOTOR
 - REEL MOTOR
 - SOLENOID

3-2. REPLACEMENT OF THE PINCH ROLLER BLOCK

- 1) Pull out the PINCH ROLLER BLOCK in the upper (↑) direction while releasing the PINCH ROLLER FIXATION HOOK.
- 2) Reassemble in reverse order.

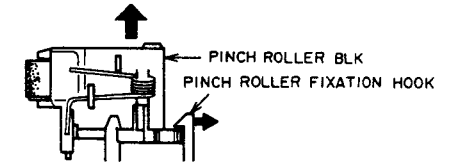

Fig. 3-1

3-3. REPLACEMENT OF THE HEAD

- 1) Remove the two HEAD FIXATION (A) SCREWS.
- 2) Pull out the HEAD and disconnect all the lead wires by soldering iron, then remove the HEAD.
- 3) Reassemble in reverse order.

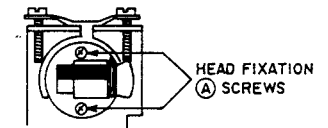

Fig. 3-2

[ATTENTION]

* Lead wire colors may change without notice. Before disconnecting the lead wires on the unit, confirm that the color of the lead wires are the same as shown in Fig. 3-3.

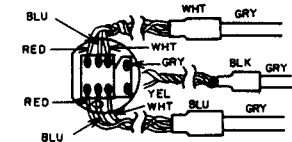

fig. 3-3

3-4. SEPARATION OF THE MECHA. BLOCK

- 1) Remove the two (B) SCREWS, then separate the upper and lower part of MECHA. BLOCK.

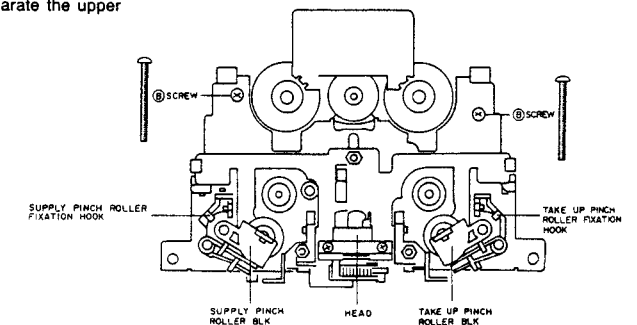

Fig. 3-4

IV. MECHANICAL ADJUSTMENT

3-5. REPLACEMENT OF THE CAPSTAN MOTOR

- 1) Separate the upper and lower of MECHA. BLOCK (Refer to 4-4. SEPARATION OF MECHA. BLOCK)
- 2) Disconnect the lead wires of the CAPSTAN MOTOR with a soldering iron.
- 3) Remove the CAPSTAN MOTOR FIXATION Ⓢ SCREW, then remove the CAPSTAN MOTOR.
- 4) Reassemble in the reverse order and set the drive belt.

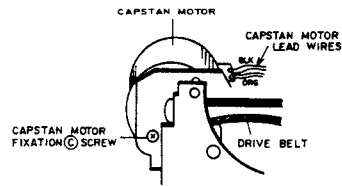

Fig. 3-5

3-6. REPLACEMENT OF THE DRIVE BELT

- 1) Remove the two BRACKET FIXATION Ⓢ SCREWS and separate the BRACKET from the MECHA. BLOCK. Replace the drive belt.
- 2) Reassemble in the reverse order.

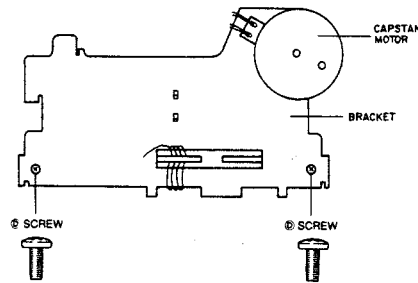

Fig. 3-6

3-7. REPLACEMENT OF THE REEL MOTOR

- 1) Remove all the solder on the detection switches, lead wires of the solenoid and REEL MOTOR leads on the MECHA PCB with a soldering iron (Refer to Fig. 3-7).
- 2) Remove the REEL PULSE DETECTION PCB on the front side of the MECHA. BLOCK while releasing the REEL PULSE DETECTION PCB FIXATION HOOKS.
- 3) Remove the two REEL MOTOR FIXATION Ⓢ SCREWS, then remove the REEL motor.
- 4) Reassemble in the reverse order.

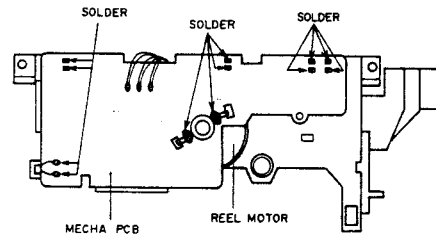

Fig. 3-7

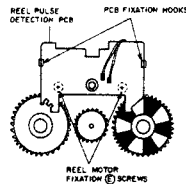

Fig. 3-8

3-8. REPLACEMENT OF THE SOLENOID

- 1) Separate upper and lower part of the MECHA. BLOCK (Refer to 4-4. SEPARATION OF MECHA. BLOCK).
- 2) Disconnect the lead wires of the SOLENOID with a soldering iron.
- 3) Remove the SOLENOID while releasing the SOLENOID FIXATION HOOK.
- 4) Reassemble in reverse order.

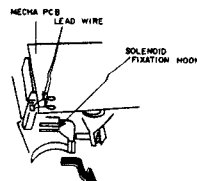

Fig. 3-9

[PRECAUTION]

- * Before adjustment, clean and de-magnetize the heads and tape guides.
- * Do not use magnetized tools for the following adjustments.

4-1. CONFIRMATION OF THE PINCH ROLLER PRESSURE

- * Before confirmation of the pinch roller pressure, remove the cassette lid and cassette holder.

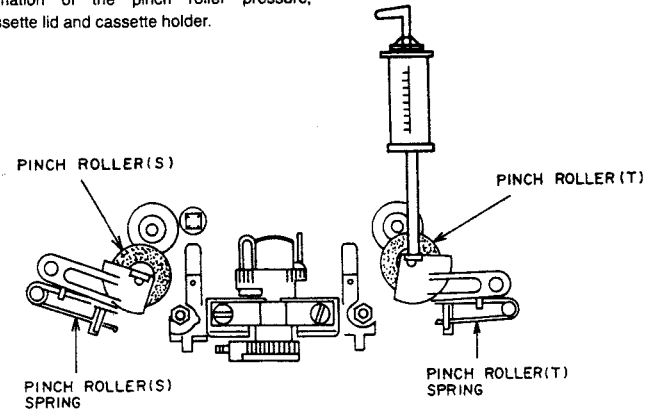

Fig. 4-1

Engage the FWD PLAY mode. Push the PINCH ROLLER (T) shaft down with the SPRING GAUGE so that the PINCH ROLLER (T) is kept 1 or 2 mm away from the capstan, then reduce the pressure of the SPRING GAUGE little by little and read the SPRING GAUGE at the moment the PINCH ROLLER (T) touches the capstan and begins to rotate.

Also confirm the PINCH ROLLER (S) pressure in the same manner as above. If the pressure is not within 360 ± 15 g, replace the PINCH ROLLER (T) or (S) SPRING.

4-2. CONFIRMATION OF THE WINDING TORQUE IN EACH MODE

Insert a CASSETTE TORQUE METER (AT-751179) and measure the torque in each mode.

For fast forward and rewind, measure the torque at the end of the tape when the tape has stopped running.

PLAY BACK mode

Take up torque : $40 \pm_{10}^{20}$ g-cm
Back tension torque : $10 \pm_{10}^{15}$ g-cm

FAST FORWARD and REWIND mode

Take up torque : $120 \pm_{50}^{130}$ g-cm

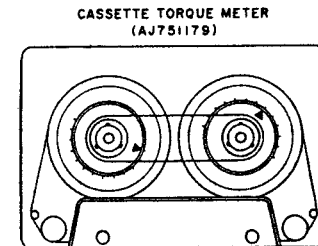

Fig. 4-2

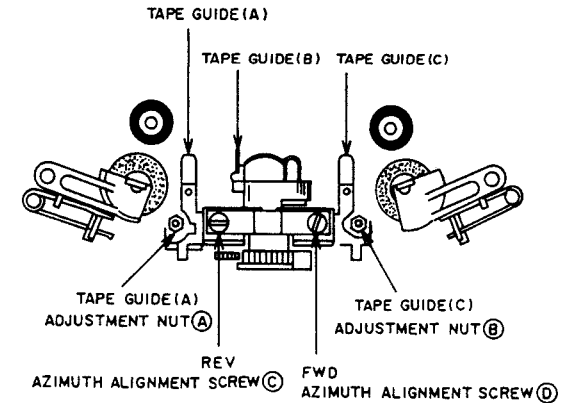

Fig. 4-3

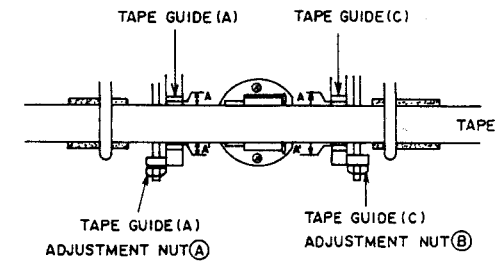

Fig. 4-4

4-3. ADJUSTMENT OF THE TAPE GUIDE HEIGHT

- 1) Set the MIRROR CASSETTE TAPE (AJ-751178) and engage the FWD PLAY mode.
- 2) Adjust the TAPE GUIDE (A) HEIGHT ADJUSTMENT (A) NUT so that both spaces (A and A') on the TAPE GUIDE (A) are equal.
- 3) Adjust the TAPE GUIDE (C) HEIGHT ADJUSTMENT (B) NUT so that both spaces (B and B') on the TAPE GUIDE (C) are equal.
- 4) Repeat the above steps 2) and 3) until the tape runs smoothly and without any curls or wrinkles at the TAPE GUIDE (A), (B) and (C).

4-4. ADJUSTMENT OF THE REC/PB HEAD AZIMUTH ALIGNMENT

- 1) Connect the AC milli-voltmeters to the L-ch. and R-ch of the LINE OUT and connect oscilloscope's input CH-1 and CH-2 to the output of the AC milli-voltmeters.
- 2) Play back a 10 kHz, -15 VU test tape (AT-750778) and adjust the REC/PB HEAD AZIMUTH ALIGNMENT (C) (FWD PLAY) or (D) (REV PLAY) SCREW so that the reading on the AC milli-voltmeters are at maximum and waveforms on the oscilloscope are in the same phase.

- 3) After adjustment, paint lock the REC/PB HEAD AZIMUTH ALIGNMENT (C) and (D) SCREWS.

4-5. ADJUSTMENT OF TAPE SPEED

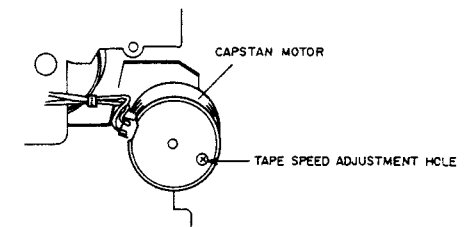

Fig. 4-5

- 1) Connect a frequency counter to L-ch or R-ch of the LINE OUT.
- 2) Play back a 3,150 Hz test tape (AT-751263) and adjust the TAPE SPEED CONTROL VR (inside the capstan motor) with a small flat screwdriver so that the reading on the frequency counter is $3,150 \pm 10$ Hz.

V. ELECTRICAL ADJUSTMENT

PRECAUTIONS BEFORE ADJUSTMENT

1. Before adjustment, clean and de-magnetize heads and tape guides.
2. Without specified switches and control knobs are set as below.

BIAS control : Center (click) position
 REC LEVEL control : Maximum (10) position
 REC BALANCE control : Center (click) position
 DOLBY NR switch : Off
 MPX FILTER switch : Off
 CD/DAT DIRECT switch : Off

3. Input signal is supplied from LINE IN.

4. Use the following recording test tapes.

NORMAL position : MAXELL UD 160
 CrO₂ position : TDK SA 60
 METAL Position : TDK MA 60

5. 0 dBs = 0.775 V

6 HX PRO RESONANCE FREQUENCY
1. METAL recording test tape
2. REC PLAY
3. TP1 (+) and TP2 (-), T271 and T271b
4. * Connect DC voltmeter between TP1 (+) and (-). *Adjust T271 and T271b alternately so that the DC voltmeter reading is at minimum.

10 RECORDING LEVEL
1. 1 kHz, -6.0 dBs (LINE OUT), NORMAL recording test tape
2. REC PLAY→PLAY (Play back)
3. LINE OUT, VR251 (L-ch) / VR251b (R-ch) and (-).
4. * Connect AC milli-voltmeter to LINE OUT. *-6.0 ± 0.3 dBs

2 PLAYBACK LEVEL
1. 315 Hz test tape (AT-750773)
2. PLAY
3. LINE OUT, VR201 (L-ch) / VR201b (R-ch)
4. * Connect AC milli-voltmeters to LINE OUT. *-6.0 ± 0.2 dBs

3 PLAYBACK EQUALIZER
1. 10 kHz test tape (AT-750778)
2. PLAY
3. LINE OUT, VR202 (L-ch) / VR202b (R-ch)
4. * Connect AC milli-voltmeter to LINE OUT. *-21.0 ± 0.3 dBs

4 MPX FILTER
1. 19 kHz, -6.0 dBs (LINE OUT, MPX FILTER switch "OFF")
2. REC PAUSE
3. LINE OUT, FL221 (L-ch) / FL221b (R-ch)
4. * Connect AC milli-voltmeter to LINE OUT and turn the MPX FILTER switch on. *Minimum output level (Less than -36 dBs)

5 BIAS OSC FREQUENCY
1. CrO ₂ recording test tape
2. REC PLAY
3. P271 Pin ①, T272
4. * Connect frequency counter between P271 Pin ① and GND. *100.0 ± 0.2 kHz

7 NORMAL POSITION BIAS
1. 1 kHz and 10 kHz, -29 dBs (LINE OUT), NORMAL recording test tape.
2. REC PLAY→PLAY (Play back)
3. LINE OUT, VR271 (L-ch) / VR271b (R-ch)
4. * Connect AC milli-voltmeter to LINE OUT. *Play back level difference between 1 kHz and 10 kHz is within ± 0.3 dB.

9 METAL POSITION BIAS
1. 1 kHz and 10 kHz, -29 dBs (LINE OUT), METAL recording test tape.
2. REC PLAY→PLAY (Play back)
3. LINE OUT, VR272
4. * Connect AC milli-voltmeter to LINE OUT. *Play back level difference between 1 kHz and 10 kHz is within ± 0.3 dB.

8 CrO ₂ POSITION BIAS
1. 1 kHz and 10 kHz, -29 dBs (LINE OUT), CrO ₂ recording test tape.
2. REC PLAY→PLAY (Play back)
3. LINE OUT, VR273
4. * Connect AC milli-voltmeter to LINE OUT. *Play back level difference between 1 kHz and 10 kHz is within ± 0.3 dB.

1 LEVEL METER SENSITIVITY
1. 1 kHz, -4.3 dBs (LINE OUT), NORMAL recording test tape.
2. REC PAUSE
3. LEVEL METER on the front panel, VR343 (L-ch) / VR343b (R-ch)
4. *All white segments on the level meter are lit.

STEP	ADJUSTMENT ITEM
1.	TEST TAPE/INPUT SIGNAL
2.	MODE
3.	TEST POINT, ADJUSTMENT PART
4.	REMARKS (*) and RESULT (*)

Test Point Adjustment Part

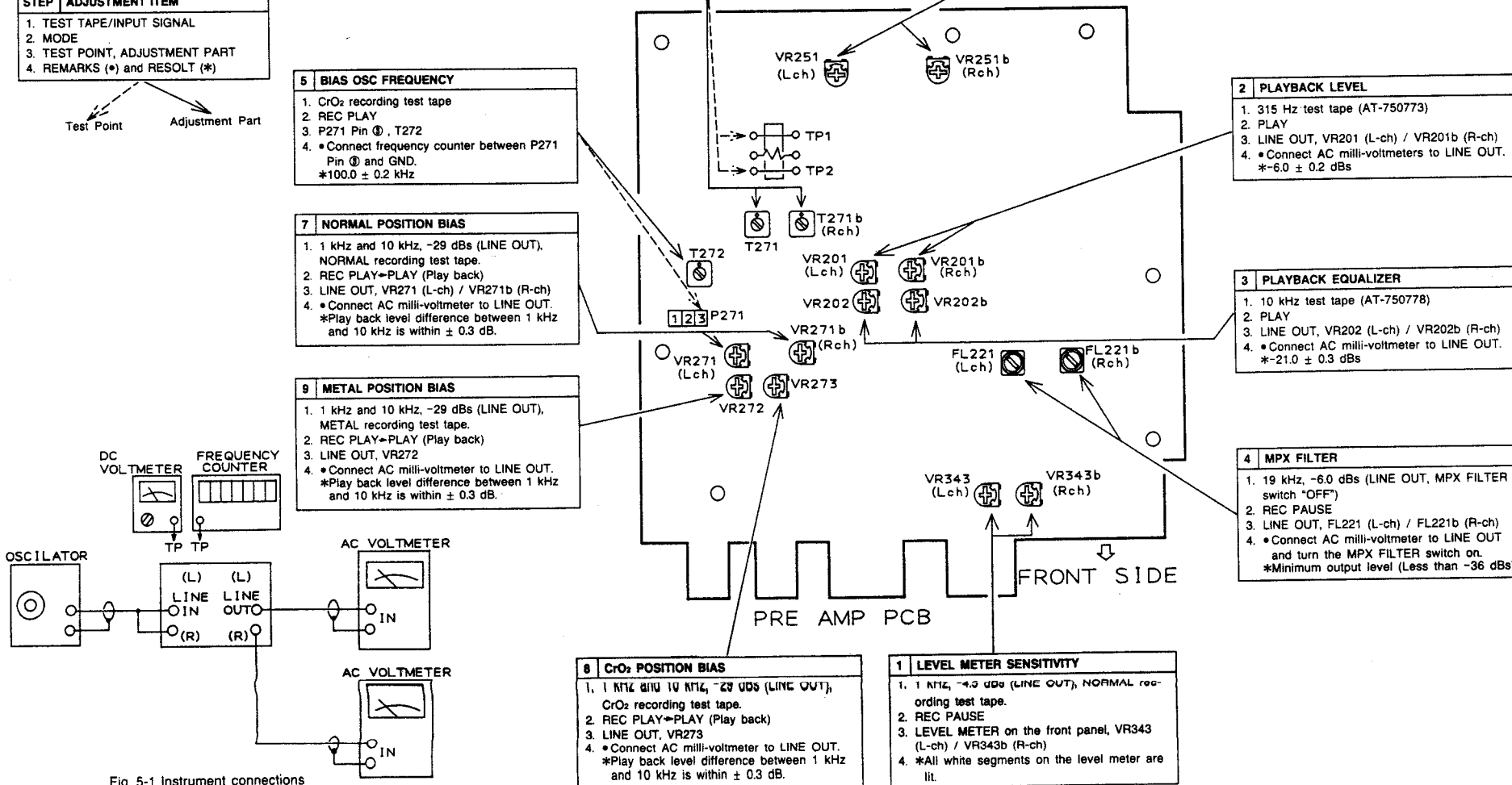
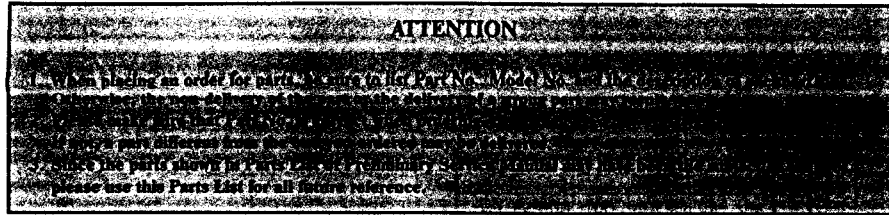

Fig. 5-1 Instrument connections

VI. PARTS LIST



HOW TO USE THIS PARTS LIST

1. This Parts List lists those parts which are considered necessary for repairs. Other common parts, such as resistors and capacitors, are listed in the "Common List for Service Parts" from which these parts should be selected and stocked.
2. The Recommended Spare Parts List shows those parts in the Parts List which are considered particularly important for service.
3. Parts not shown in the Parts List and "Common List for Service Parts" will not in principle be supplied.
4. How to read the Parts List.

a) Mechanism Block

2. HEAD BASE BLOCK

REF. NO.	PART NO.	DESCRIPTION
1	BH-T2023A320A	HEAD BASE BLOCK
2	HP-H2206A010A	HEAD R/P PR4-8FU C
3	ZS-477876	PAN20x03STL CMT
4	ZS-536488	BID20x08STL CMT
5	ZG-402895	SP CS ANGLE ADJUST

SP (Service Parts) Classification

This number corresponds with the individual parts index number in that figure.

b) PC Board

6. MAIN PC BOARD

REF. NO.	PART NO.	DESCRIPTION
IC1	EI-324536	IC HD14049BP
IC2	EI-336801	IC MB8841-564M
C1A	EC-338399	C MMY V 223M 250AC [U,E,B,S]
C1B	EC-350949	C MMY V 223M 250DC [J]
C1C	EC-338397	C MMY V 223M 125AC [C,A]
X1	EI-318384	OSC X'TAL NC-18C

Symbols for primary destination

[A] : AAL (U.S.A) [S] : SAA (Australia)
 [B] : BEAB (England) [U] : U/T (Universa Area)
 [C] : CSA (Canada) Area
 [E] : CEE (Europe) [V] : VDE (W. Germany)
 [J] : JPN (Japan) [Y] : Custom Version

SP (Service Parts) Classification

These reference symbols correspond with component symbols in the Schematic Diagrams.

The available PC Board Blocks are listed separately.

5. When Part No. is known, Parts Index at end of Parts List can be used to locate where that part is shown in Parts List by its Reference No. listed at right of Part No.

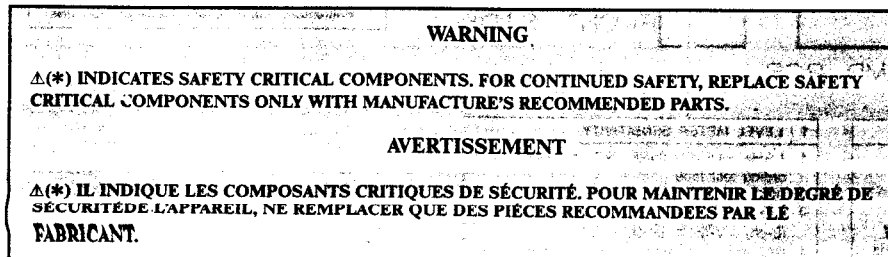

1. RECOMMENDED SPARE PARTS

We suggest you to stock the following Recommended Spare Part items listed below since they can cover most of the routine service.

Ref.No.	Part No.	Description
64	ET-365394	TR 2SC3242A E.F.G F05
65	ET-378524J	TR 2SC3383 S.T.U
66	ET-389802J	TR 2SD2159 V F05
67	EV-389258J	VR ROTARY RK1631110 B102 [BIAS]
68	EV-389258J	VR ROTARY RK1631110EAA W254 [REC BALANCE]
69	EV-389262J	VR ROTARY RK16312A0 A503X2 [PHONES LEVEL]
70	EV-389263J	VR SPL RK1612MA A104X2 [REC LEVEL]
71	*EW-363655	AC CORD 200 0129AVFF B250 A JT [U]
72	*EW-363668	AC CORD 200 0364 LCFL B250 A EV [E]
73	HR-H2511A020A	HEAD EPR4-16 EPR4-16
74	MB-729451J	BELT CAPSTAN
75	MP-729460J	PINCH ROLLER
1	BB-T2119A040A	MECHA BLK GX-R3500
2	BM-729455J	MOTOR CAPSTAN SHE2L55(GX-Z6100)
3	BM-729478J	MOTOR REEL PART SGE09009
4	*BT-394766J	TRANS POW T2119 E [E]
5	*BT-394765J	TRANS POW T2119 U [U]
6	ED-389252J	D LED SLR-54VR5F RED
7	ED-307572	D SILICON H 1S5131
8	ED-624903	D SILICON H 1S2473
9	*ED-389840J	D SILICON 1SR139-100HS F10
10	ED-346574	D ZENER H HZ22-2L
11	ED-346582	D ZENER H HZ30-1L
12	ED-346598	D ZENER H HZ4 C2
13	ED-346602	D ZENER H HZ5 B3
14	ED-343410	D ZENER H HZ6A1L
15	ED-346525	D ZENER H HZ6A3L
16	ED-346532	D ZENER H HZ7A3L
17	ED-346538	D ZENER H HZ9A2L
18	ED-346546	D ZENER H HZ9C3L
19	*EF-339905	FUSE SEMKO T 250V 200MA [E]
20	*EF-258344	FUSE SEMKO T 250V 800MA [E]
21	*EF-306949	FUSE TSC A 250V 1.25A [U]
22	*EF-306125	FUSE TSC A 250V 315MA [U]
23	EI-373980	IC BA15218N
24	EI-389264J	IC BA6209N
25	EI-353421	IC BA6229
26	EI-384868J	IC BU4030B
27	EI-359985	IC CX20187
28	EI-356327	IC HA12067NT
29	EI-337013	IC LB1290
30	EI-345765	IC LB1292
31	EI-389255J	IC M50743-12SSP T2119
32	EI-357498	IC M51143AL
33	EI-393323J	IC M5218AL-771
34	EI-393325J	IC M5218AP
35	EI-360043	IC M5220P
36	EI-373383	IC UPC1297CA
37	EI-372031	OSC CE W/C FCR8.0MC 8.0MHZ
38	EM-389253J	IND FL CP5388GR DOUBLE
39	EO-389852J	COIL OSC 1 T2119 EH 100.0KHZ
40	EO-389851J	COIL OSC 1 T2119(HX) 100.0KHZ
41	*ER-322787	R CB H S10 FS RDS 1/4W 100J
42	*ER-325114	R CB H S10 FS RDS 1/4W 330J
43	*ER-302241	R CB H S10 FS RDS 1/4W 4R7J
44	*ER-318248	R FUSE H S10 ERD2FC 1/4W 47R0G
45	ES-729477J	LEAF SW
46	*ES-371104	SW PUSH SDDL01 01-1 [POWER]
47	ES-389244J	SW PUSH SPUY43 4THROW
48	ES-370965	SW SLIDE SSSU02 1-01-03N [REV SELECTOR]
49	ES-349474	SW TACT SKHHAM004A [REC PAUSE]
50	ET-381637J1	DETECTOR GP1U521X [REMOTE SENSOR]
51	ET-729536J	DETECTOR SPI-314-BD
52	ET-356336	TR DT114ES
53	ET-369248	TR DT114YS
54	ET-354415	TR DT144ES
55	ET-382952J	TR DTC123ES
56	ET-370311	TR DTC143XS
57	ET-373391	TR DTC143ZS
58	ET-354414	TR DTC144ES
59	ET-729496J	TR PHOTO NUL5161KF1 B
60	ET-347738	TR 2SA1282A E.F F05
61	ET-389803J	TR 2SA933S R.S
62	ET-389251J	TR 2SC1740S S F05
63	ET-308977	TR 2SC2274K F F05

MECHA BLOCK

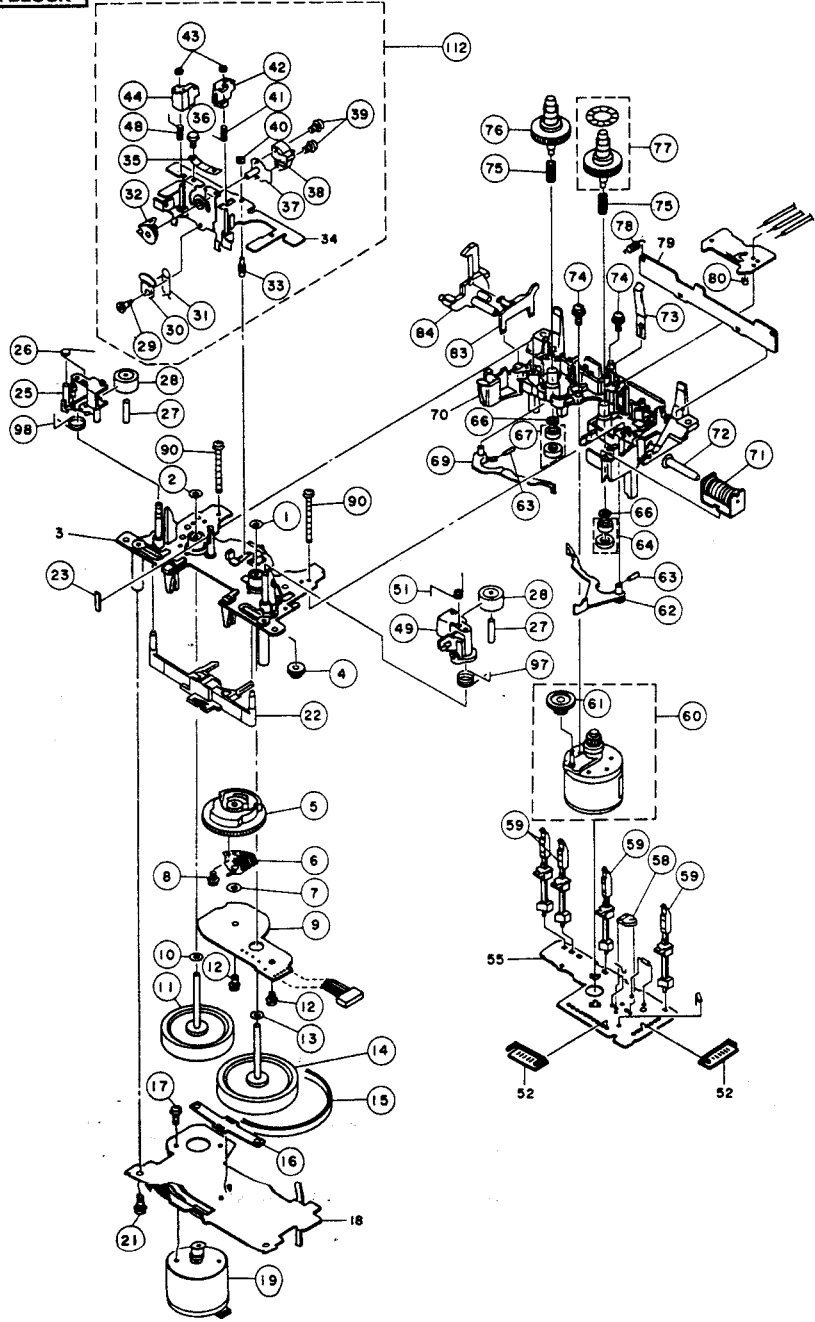

2. MECHA BLOCK

Ref.No.	Part No.	Description
1	ZW-729545J	TW25
2	ZW-729440J	TW22
4	MZ-729441J	GEAR ASSIST
5	MZ-729442J	CAM
6	ES-729443J	SW ROTARY
7	ZW-729444J	WASHER 30X080X050 PSL
8	ZS-729445J	PAN 20X03
9	EA-729446J	PC CONTROL
10	ZW-729447J	WASHER
11	MI-729516J	FLYWHEEL
12	ZS-729449J	PAN 20X30
13	ZW-729517J	WASHER 26X047X050
14	MI-729518J	FLYWHEEL
15	MB-729451J	BELT CAPSTAN
16	MZ-729452J	HOLDER THRUST
17	ZS-729454J	PAN 26X03
19	BM-729455J	MOTOR CAPSTAN SHE2L55(GX-26100)
21	ZS-729456J	SCREW TAPPING 26X08
22	ML-729519J	LEVER SLIDE
23	SZ-729520J	REFLECTOR
25	ML-729521J	ARM PINCH ROLLER (L)
26	ZG-729522J	SP ARM PINCH ROLLER (L)
27	MS-729475J	SHAFT PINCH ROLLER
28	MP-729460J	PINCH ROLLER
29	ZS-729523J	SCREW SPECIAL 20X03
30	MZ-729524J	GEAR REVERSE
31	ZG-729525J	SP REVERSE
32	MZ-729526J	GEAR HEAD ROTARY
33	MS-729527J	SHAFT HEAD BASE
35	ZG-729528J	SP AZIMUSH
36	ZS-729529J	SCREW AZIMUSH 20X064
37	HZ-729530J	BASE HEAD
38	HR-H2511A020A	HEAD EPR4-16 EPR4-16
39	ZS-729531J	PAN 14X60
40	ZW-729532J	N25
41	ZG-729533J	SP FWD TAPE GUIDE
42	HZ-729534J	GUIDE TAPE
43	ZW-729535J	N20
44	ET-729536J	DETECTOR SPI-314-BD
48	ZG-729537J	SP REV TAPE GUIDE
49	ML-729474J	ARM PINCH ROLLER (R)
51	ZG-729476J	SP ARM PINCH ROLLER (R)
58	EV-729538J	R S-FIX H 303
59	ES-729477J	LEAF SW
60	BM-729478J	MOTOR REEL PART SGE09009
61	MZ-729479J	GEAR IDLER
62	ML-729480J	LEVER ASSIST (A)
63	ZG-729481J	SP LEVER ASSIST
64	MR-729482J	PULLEY BRAKE (T) PART(WH)
66	ZW-729483J	WASHER 26X055X013(PSL)
67	MR-729484J	PULLEY BRAKE (S) PART (BK)
69	ML-729485J	LEVER ASSIST (B)
71	EP-729487J	SOLENOID
72	MS-729488J	SHAFT SOLENOID
73	ZG-729489J	SP PLATE CASSETTE HOLDER
74	ZS-729490J	SCREW SPECIAL 26X016
75	ZG-729491J	SP REEL TABLE
76	MT-729492J	REEL TABLE (S)
77	MT-729493J	REEL TABLE (T)
78	ZG-729494J	SP PULL CASSETTE PLATE
80	ET-729496J	TR PHOTO NUL5161KF1 B
83	ML-729498J	LEVER
84	ML-729499J	LEVER EJECT
90	ZS-729500J	PAN 26X30
97	ZG-729540J	SP TORSION RETURN (R)
98	ZG-729541J	SP TORSION RETURN (L)
112	BH-729544J	HEAD BLK GX-R3500

NOTE:
Parts will not be supplied if they are not listed in the parts list, even if they appear on the assembling illustrations with reference No.

3. P.C BOARD BLOCK

Ref.No.	Part No.	Description
1	BA-T2119A020A	PC(#) PRE AMP BLK GX-R3500 (U)
2	BA-T2119A020B	PC(#) PRE AMP BLK GX-R35(E) (E)
3	BA-T2119A030A	PC(#) SYSCON BLK GX-R3500

PC (#) PRE AMP BLK CONSISTS OF FOLLOWING P.C BOARD.

- PRE AMP P.C BOARD
- POWER P.C BOARD
- HEADPHONE P.C BOARD

PC (#) SYSCON BLK CONSISTS OF FOLLOWING P.C BOARD.

- SYSCON P.C BOARD
- TIMER SW P.C BOARD
- LED P.C BOARD

4. PRE AMP P.C BOARD

Ref.No.	Part No.	Description
C271	EC-347247	C MC V F05 FM 101J 500DC
C278	EC-427948	C MC V FM 100J 500DC
C279	EC-390699J	C PP V F10 APH 822J 400DC
C807	EC-363490	C EC V CUT SME 222M 18.0DC
C808	EC-373358	C EC V CUT SME 103M 18.0DC
C809	EC-368613	C EC V CUT SME 102M 25.0DC
D291	ED-624903	D SILICON H 1S2473
D292	ED-624903	D SILICON H 1S2473
D321	ED-624903	D SILICON H 1S2473
D341	ED-346538	D ZENER H H29A2L
D342	ED-346538	D ZENER H H29A2L
D343	ED-346546	D ZENER H H29C3L
D344	ED-346525	D ZENER H H26A3L
D346	ED-346574	D ZENER H H222-2L
D347	ED-346582	D ZENER H H230-1L
D801	*ED-389840J	D SILICON 1SR139-100HS F10
D802	*ED-389840J	D SILICON 1SR139-100HS F10
D803	*ED-389840J	D SILICON 1SR139-100HS F10
D804	*ED-389840J	D SILICON 1SR139-100HS F10
D805	*ED-389840J	D SILICON 1SR139-100HS F10
D806	*ED-389840J	D SILICON 1SR139-100HS F10
D807	*ED-389840J	D SILICON 1SR139-100HS F10
D808	*ED-389840J	D SILICON 1SR139-100HS F10
D809	*ED-389840J	D SILICON 1SR139-100HS F10
D810	*ED-389840J	D SILICON 1SR139-100HS F10
D811	*ED-389840J	D SILICON 1SR139-100HS F10
D812	*ED-389840J	D SILICON 1SR139-100HS F10
D813	ED-343410	D ZENER H H26A1L
D814	ED-346602	D ZENER H HZ5 B3
D815	*ED-389840J	D SILICON 1SR139-100HS F10
D816	*ED-389840J	D SILICON 1SR139-100HS F10
D822	ED-346598	D ZENER H HZ4 C2
D824	ED-346532	D ZENER H HZ7A3L
D825	ED-624903	D SILICON H 1S2473
F1A	*EF-306125	FUSE TSC A 250V 315MA (U)
F1B	*EF-339905	FUSE SEMKO T 250V 200MA (E)
F2A	*EF-306125	FUSE TSC A 250V 315MA (U)
F2B	*EF-339905	FUSE SEMKO T 250V 200MA (E)
F3A	*EF-306949	FUSE TSC A 250V 1.25A (U)
F3B	*EF-258344	FUSE SEMKO T 250V 800MA (E)
F4A	*EF-306949	FUSE TSC A 250V 1.25A (U)
F4B	*EF-258344	FUSE SEMKO T 250V 800MA (E)
FL221	EH-370972	FILTER LC LP 370972
FL251	EO-315758	COIL TUN 1 100Z-431 100.00KC
FR342	*ER-318248	R FUSE H S10 ERD2FC 1/4W 47R0G (E)
IC201	EL-360043	IC MS220P
IC211	EL-393325J	IC MS218AP
IC221	EL-359985	IC CX20187
IC251	EL-393325J	IC MS218AP
IC271	EL-373383	IC UPC1297CA
IC291	EL-384868J	IC BU4030B

Ref.No.	Part No.	Description
IC301	EL-357498	IC M51143AL
IC311	EL-393323J	IC MS218AL-771
IC321	EL-373980	IC BA15218N
IC322	EL-373980	IC BA15218N
IC821	EL-389264J	IC BA6209N
IC822	EL-353421	IC BA6229
J341	EJ-389288J	PIN J YK21-0019A 6P
L221	EO-379950J	COIL FIX 1 7132 223J
L251	EO-321295	COIL FIX 1 RC875 47ZJ
R277	*ER-302241	R CB H S10 FS RDS 1/4W 4R7J
R821	*ER-325114	R CB H S10 FS RDS 1/4W 330J
R826	*ER-322787	R CB H S10 FS RDS 1/4W 100J
SW341	ES-389244J	SW PUSH SPUY43 4THROW
T271	EO-389851J	COIL OSC 1 T2119(HX) 100.0KHZ
T272	EO-389852J	COIL OSC 1 T2119 EH 100.0KHZ
TR201	ET-378524J	TR 2SC3383 S,T,U
TR202	ET-378524J	TR 2SC3383 S,T,U
TR203	ET-389251J	TR 2SC1740S S F05
TR204	ET-389251J	TR 2SC1740S S F05
TR205	ET-389251J	TR 2SC1740S S F05
TR206	ET-389251J	TR 2SC1740S S F05
TR207	ET-389803J	TR 2SA933S R,S
TR221	ET-389251J	TR 2SC1740S S F05
TR222	ET-389251J	TR 2SC1740S S F05
TR250	ET-389251J	TR 2SC1740S S F05
TR251	ET-389251J	TR 2SC1740S S F05
TR252	ET-389251J	TR 2SC1740S S F05
TR253	ET-389251J	TR 2SC1740S S F05
TR254	ET-389251J	TR 2SC1740S S F05
TR271	ET-389837J	TR 2SC1740S E F05
TR272	ET-389837J	TR 2SC1740S E F05
TR273	ET-370311	TR DTC143XS
TR274	ET-308977	TR 2SC2274K F F05
TR275	ET-308977	TR 2SC2274K F F05
TR276	ET-389802J	TR 2SD2159 V F05
TR277	ET-373391	TR DTC143ZS
TR278	ET-373391	TR DTC143ZS
TR279	ET-373391	TR DTC143ZS
TR301	ET-389251J	TR 2SC1740S S F05
TR321	ET-354414	TR DTC144ES
TR341	ET-365394	TR 2SC3242A E,F,G F05
TR342	ET-347738	TR 2SA1282A E,F F05
TR343	ET-369248	TR DTA114YS
TR344	ET-373391	TR DTC143ZS
TR345	ET-373391	TR DTC143ZS
TR346	ET-373391	TR DTC143ZS
TR347	ET-378524J	TR 2SC3383 S,T,U
TR348	ET-389803J	TR 2SA933S R,S
TR349	ET-389803J	TR 2SA933S R,S
TR350	ET-389802J	TR 2SD2159 V F05
TR351	ET-389802J	TR 2SD2159 V F05
TR352	ET-389802J	TR 2SD2159 V F05
TR354	ET-354415	TR DTA144ES
TR355	ET-389251J	TR 2SC1740S S F05
TR356	ET-389251J	TR 2SC1740S S F05
TR357	ET-389251J	TR 2SC1740S S F05
TR358	ET-389251J	TR 2SC1740S S F05
TR801	ET-389251J	TR 2SC1740S S F05
TR820	ET-389251J	TR 2SC1740S S F05
TR821	ET-353897	TR DTC114ES
TR823	ET-389802J	TR 2SD2159 V F05
TR824	ET-356336	TR DTA114ES
TR825	ET-389802J	TR 2SD2159 V F05
TR826	ET-356336	TR DTA114ES
TR827	ET-389802J	TR 2SD2159 V F05
TR828	ET-370311	TR DTC143XS
VR201	EV-356579	R S-FIX H RH0615C 0.10W 102
VR202	EV-356577	R S-FIX H RH0615C 0.10W 103
VR251	EV-358829	R S-FIX H RH0615C 0.10W 223
VR271	EV-356579	R S-FIX H RH0615C 0.10W 682
VR272	EV-356577	R S-FIX H RH0615C 0.10W 103
VR273	EV-357619	R S-FIX H RH0615C 0.10W 104
VR274	EV-389258J	VR ROTARY RK1631110 B102 (BIAS)
VR311	EV-389262J	VR ROTARY RK16312AO A503X2 (PHONES LEVEL)
VR341	EV-389259J	VR ROTARY RK1631110IEAA W254 (REC BALANCE)
VR342	EV-389263J	VR SPL RK16Y12MA A104X2 (REC LEVEL)
VR343	EV-357619	R S-FIX H RH0615C 0.10W 104

5. POWER SW P.C BOARD

Ref.No.	Part No.	Description
C801	*EC-320548	C CE V F 103Z 250AC
SW801	*ES-371104	SW PUSH SDDLD1 01-1 [POWER]

6. HEADPHONE P.C BOARD

Ref.No.	Part No.	Description
J342	EJ-369995	PHONE J 3P HLJ0540-410 GP 6.3 (PHONES)

7. SYSCON P.C BOARD

Ref.No.	Part No.	Description
D101	ED-307572	D SILICON H 1SS131
D102	ED-307572	D SILICON H 1SS131
D103	ED-307572	D SILICON H 1SS131
IC101	EH-389255J	IC M50743-125SP T2119
IC102	EH-358327	IC HA12067NT
IC103	EH-337013	IC LB1290
IC104	EH-345765	IC LB1292
IC105	EH-345765	IC LB1292
IC106	EH-345765	IC LB1292
IN101	EM-389253J	IND FL CP5388GR DOUBLE
RM101	ET-381637J1	DETECTOR GP1U521X [REMOTE SENSOR]
SW101	ES-370965	SW SLIDE SSSU02 1-01-03N [REV SELECTOR]
TR101	ET-382952J	TR DTC123ES
TR102	ET-382952J	TR DTC123ES
TS101	ES-349474	SW TACT SKHHAM004A [REC PAUSE]
TS102	ES-349474	SW TACT SKHHAM004A [REW]
TS103	ES-349474	SW TACT SKHHAM004A [FF]
TS104	ES-349474	SW TACT SKHHAM004A [REV]
TS105	ES-349474	SW TACT SKHHAM004A [FWD]
TS106	ES-349474	SW TACT SKHHAM004A [STOP]
TS107	ES-349474	SW TACT SKHHAM004A [MUTE]
TS108	ES-349474	SW TACT SKHHAM004A [CLR]
TS109	ES-349474	SW TACT SKHHAM004A [E FADE]
TS110	ES-349474	SW TACT SKHHAM004A [IPSS]
TS111	ES-349474	SW TACT SKHHAM004A [B SKPI]
TS112	ES-349474	SW TACT SKHHAM004A [C.RST]
X101	EL-372031	OSC CE W/C FCR8.0MC 8.0MHZ

8. TIMER SW P.C BOARD

Ref.No.	Part No.	Description
SW102	ES-370965	SW SLIDE SSSU02 1-01-03N [TIMER]

9. LED P.C BOARD

Ref.No.	Part No.	Description
D108	ED-389252J	D LED SLR-54VR5F RED

FINAL ASSEMBLY

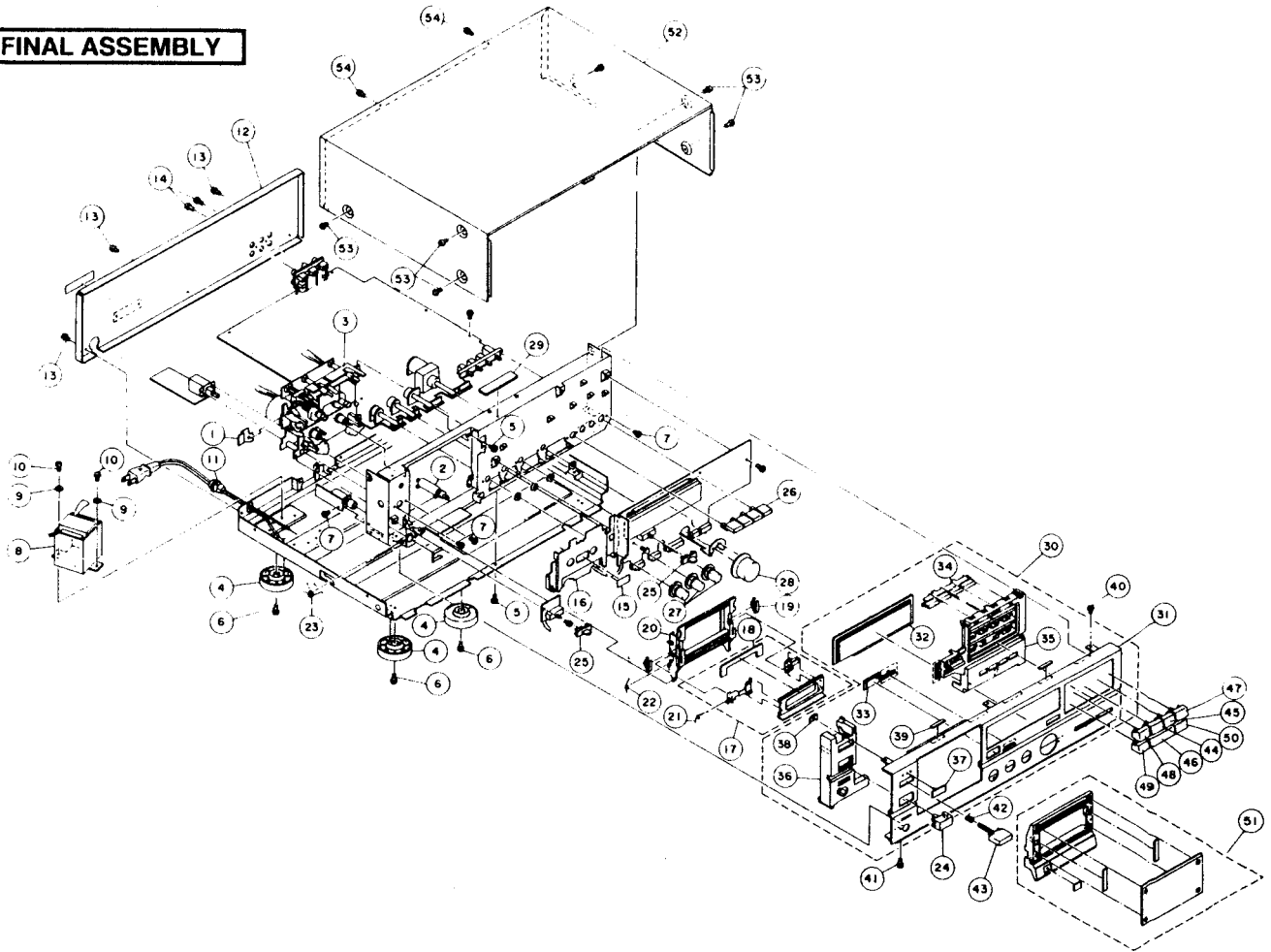

10. FINAL ASSEMBLY

Ref.No.	Part No.	Description
1	MZ-391475J	PLATE EJECT
2	MZ-391606J	DAMPER K-106
3	BB-T2119A040A	MECHA BLK GX-R3500
4	SA-379375	FOOT(N)
5	ZS-305827	ST BID30X06STL BNI
6	ZS-336714	ST BID30X12STL CMT
7	ZS-305826	ST BID30X06STL NI3
8A	*BT-394765J	TRANS POW T2119 U [U]
8B	*BT-394766J	TRANS POW T2119 E [E]
9	ZW-273914	SW40
10	ZS-322580	ST BID40X08STL BNI
11A	*EW-363655	AC CORD 200 0129AVFF B250 A UT [U]
11B	*EW-363668	AC CORD 200 0364 LCFL B250 A EV [E]
12A	SP-395924J	PANEL REAR GX-R35(U)
12B	SP-395925J	PANEL REAR GX-R35(E)
13	ZS-358953	ST BID30X08STL BNI
14	ZS-331532	PT BID30X08STL BNI
15	SZ-357722	REFLECTOR
16	SP-391527J	DECORATION PLATE MECHA
17	BZ-391578J	LID STABILIZER PART
18	SZ-391531J	SHEET DAMP
19	ZG-336615	SP PLATE CASSETTE HOLDER (B)
20	TC-391477J	CASSETTE CASE
21	ZG-391481J	SP TORSION STABILIZER(L)
22	ZG-391483J	SP TORSION RETURN
23	ZG-391478J	SP TORSION CASSETTE
24	SK-373236B	KNOB POWER-B
25	SK-391526J	KNOB SLIDE B
26	SB-391524J	BUTTON PUSH B
27	SK-391517J	KNOB VR B
28	SK-391610J	KNOB REC PART
29	SZ-391532J	SHEET DAMP(2)
30	BD-T2118A060E	PANEL FRONT BLK GX-R35-B

Ref.No.	Part No.	Description
32	SE-391502J	WINDOW METER
33	SE-384839J	WINDOW REMOCON
34	SB-391521J	BUTTON COUNTER B
35	SB-391491J	BUTTON OPERATE B
36	SP-391534J	ESCUTCHEON SIDE B
37	SM-365756C	NAME PLATE AKAI(2)
38	ZW-653163	RING CS 280STL PKR
39	SZ-378311-A	CUSHION
40	ZS-305827	ST BID30X06STL BNI
41	ZS-331532	PT BID30X08STL BNI
42	ZG-392662J	SP PUSH OPEN
43	SB-391513J	BUTTON EJECT B
44	SK-391591J	KNOB OPERATION (B) PLAY (L) B
45	SK-391592J	KNOB OPERATION (B) PLAY (R) B
46	SK-381988J	KNOB OPERATION(A2) STOP B
47	SK-373337A	KNOB OPERATION(B) FF-BLACK
48	SK-373337C	KNOB OPERATION(B) REW-BLACK
49	SK-373337E	KNOB OPERATION(B) PAUSE-BLACK
50	SK-373337G	KNOB OPERATION(B) MUTE B
51	BD-T2118A070E	LID PANEL BLK GX-R35-B
52	SP-391493J	COVER UPPER B
53	ZS-322580	ST BID40X08STL BNI
54	ZS-358953	ST BID30X08STL BNI

NOTE:

Parts will not be supplied if they are not listed in the parts list, even if they appear on the assembling illustrations with reference No.

11. ACCESSORY

Ref.No.	Part No.	Description
1	AX-394761J	REMOCON RC-G35

NOTE

ABBREVIATIONS (CASSETTE)

ABBREVIATION	EXPLANATION	ABBREVIATION	EXPLANATION
AC	Alternating Current	MIN	MINute
A/D	Analog/Digital	MML	Maximum Modulation Level
AF	Auto Fader	MOL	Maximum Output Level
AMP	AMPlifier	MPX	Multi PleX
AR	Anti Recording	NC	Not Connected (No Connection)
AT BIAS	Auto Turning BIAS	NFB	Negative Feed Back
ATT	ATTenuator	NORM	NORMal
BAL	BALance	NR	Noise Reduction
BEF	Band Elimination Filter	OSC	OSCillator (OSCillation)
BSS	Blank Search System	P	Pulse
CAP M	CAPstan Motor	PB	Play Back
CH	CHannel	QMSS	Quick Memory Search System
COMP	COMPARator	QR	Quick Reverse
CONT	CONTinuance	R CH	Right CHannel
CRLP	Computer Recording Level Processing	REC	RECOrd (RECOding)
CS	Chip Select	REV	REVerse
D/A	Digital/Analog	ROT	ROTAtion
DC	Direct Current	REW	REWind
DET	DETEctor	SEC	SECOnd
DISCRI	DISCRIminator	SELE	SELEctor
DUB	DUBbing	SENS	SENSitivity
EQ	EQualizer	SEPP	Single Ended Push Pull
FF (or F.FWD)	Fast Foward	SIG	SIGnal
FLD	FLuoresent Display	SPECT	SPECTrum
FREQ	FREQuency	STD	STanDard
FWD	ForWarD	SW	SWitch
GND	GrouND	SYSCON	SYStem CONtrol
H	High	TP	Test Point
HPF	High Pass Filter	TRIG	TRIGa
IND	INDicator	VCA	Voltage Control Attenuator
IPLS	Instant Program Location System	VOL	VOLume
L	Low	VOLT	VOLTage
L CH	Left CHannel	VR	Variable Resistor
LED	Light Emitting Diode	X'TAL	cysTAL
MEMO	MEMOry	X1	Normal speed
MICOM	MicroCOMputer	X2	Dubble speed

AKAI

MODEL **GX-R35**

SCHEMATIC DIAGRAMS AND PC BOARDS

TABLE OF CONTENTS

1. POWER SW PC BOARD	2
2. CONNECTION DIAGRAM	3
3. SYSTEM CONTROL AND OTHER PC BOARDS	4
4. SYSTEMCONTROL SCHEMATIC DIAGRAM	5
5. PRE AMP SCHEMATIC DIAGRAM	6
6. PRE AMP PC BOARD	7
7. BLOCK DIAGRAM	8
8. INFORMATION OF ICs	9

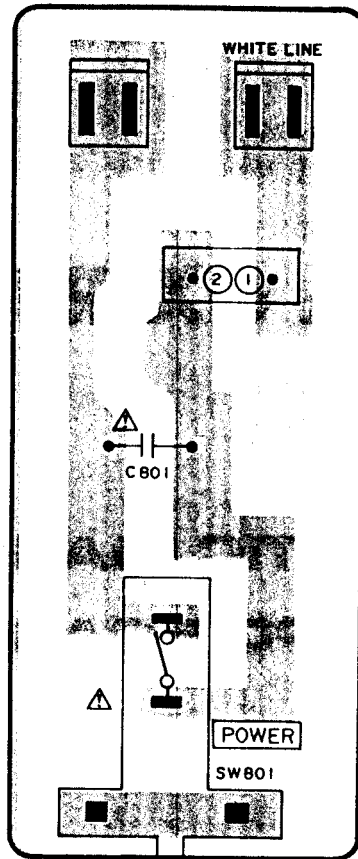

POWER SW PCB
T2119A501B

WARNING: ⚠ INDICATES SAFETY CRITICAL COMPONENTS. FOR CONTINUED SAFETY, REPLACE SAFETY CRITICAL COMPONENTS ONLY WITH MANUFACTURER'S RECOMMENDED PARTS.

AVERTISSEMENT: ⚠ IL INDIQUE LES COMPOSANTS CRITIQUES DE SÉCURITÉ. POUR MAINTENIR LE DEGRÉ DE SÉCURITÉ DE L'APPAREIL, NE REMPLACER QUE DES PIÈCES RECOMMANDÉES PAR LE FABRICANT.

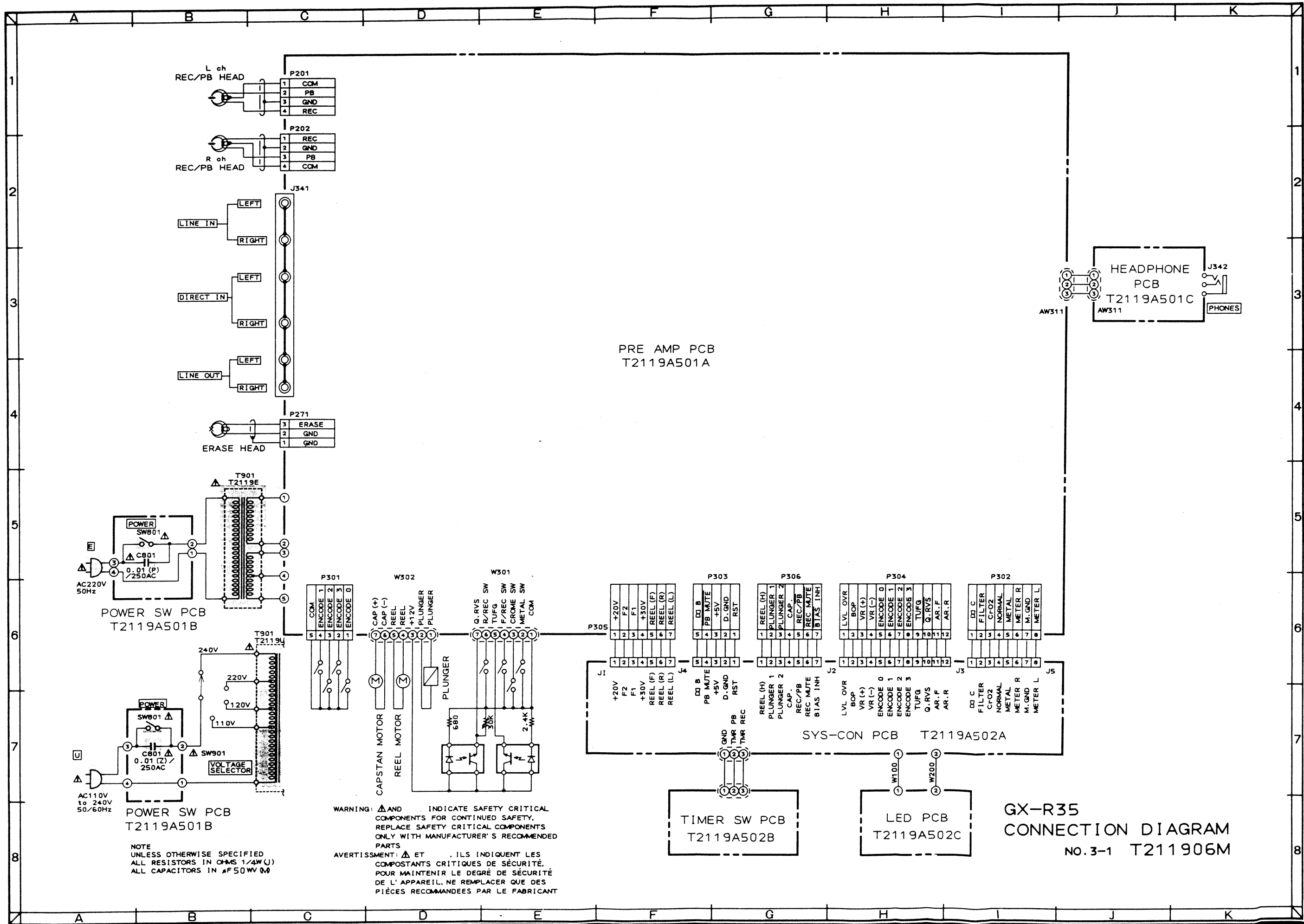

GX-R35
 CONNECTION DIAGRAM
 NO. 3-1 T211906M

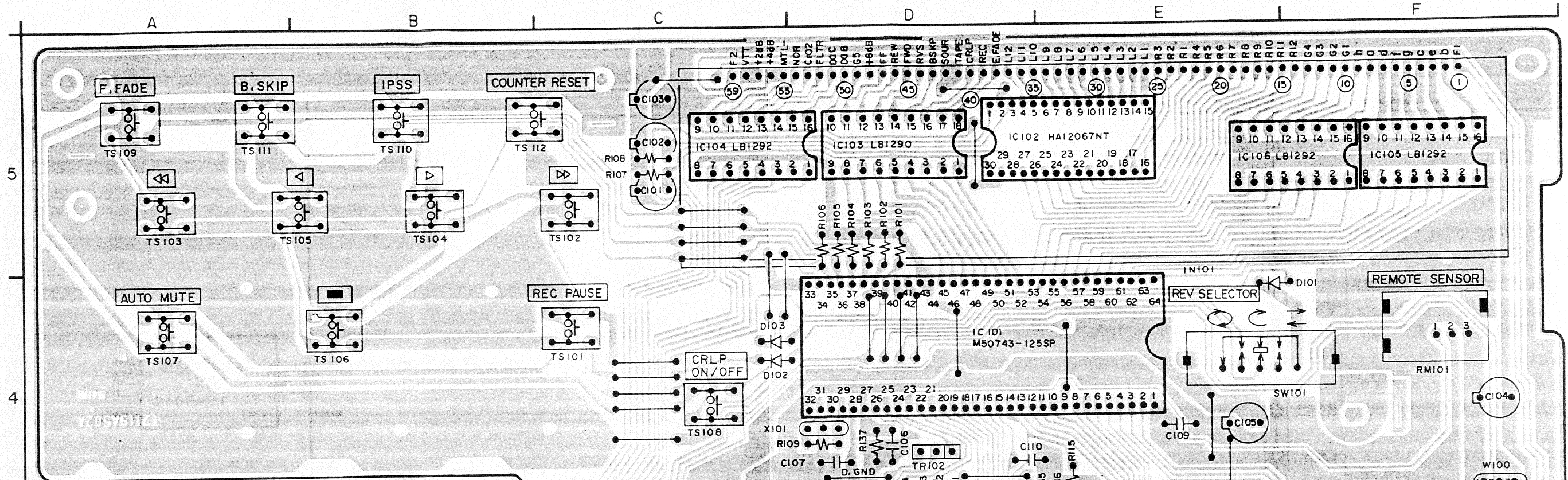

SYSTEM CONTROL PCB T2119A502A

PRINCIPAL PARTS LOCATION

IC	CONNECTOR
IC101.....D,E4	W100.....F4
IC102.....E5	W200.....D3,C3
IC103.....D5	W300.....D3
IC104.....C,D5	J1.....F3
IC105.....E,F5	J2.....E3
IC106.....F5	J3.....D3,C3
TRANSISTOR	J4.....C3
TR101.....D3	J5.....C3
TR102.....D4	

B = NPN TRANSISTOR

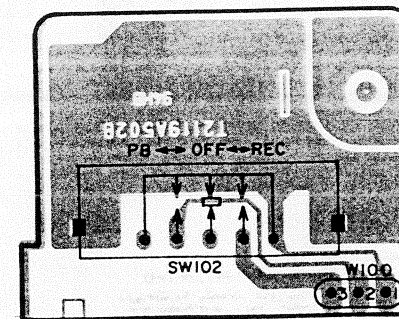
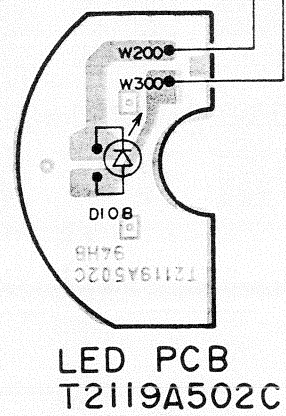

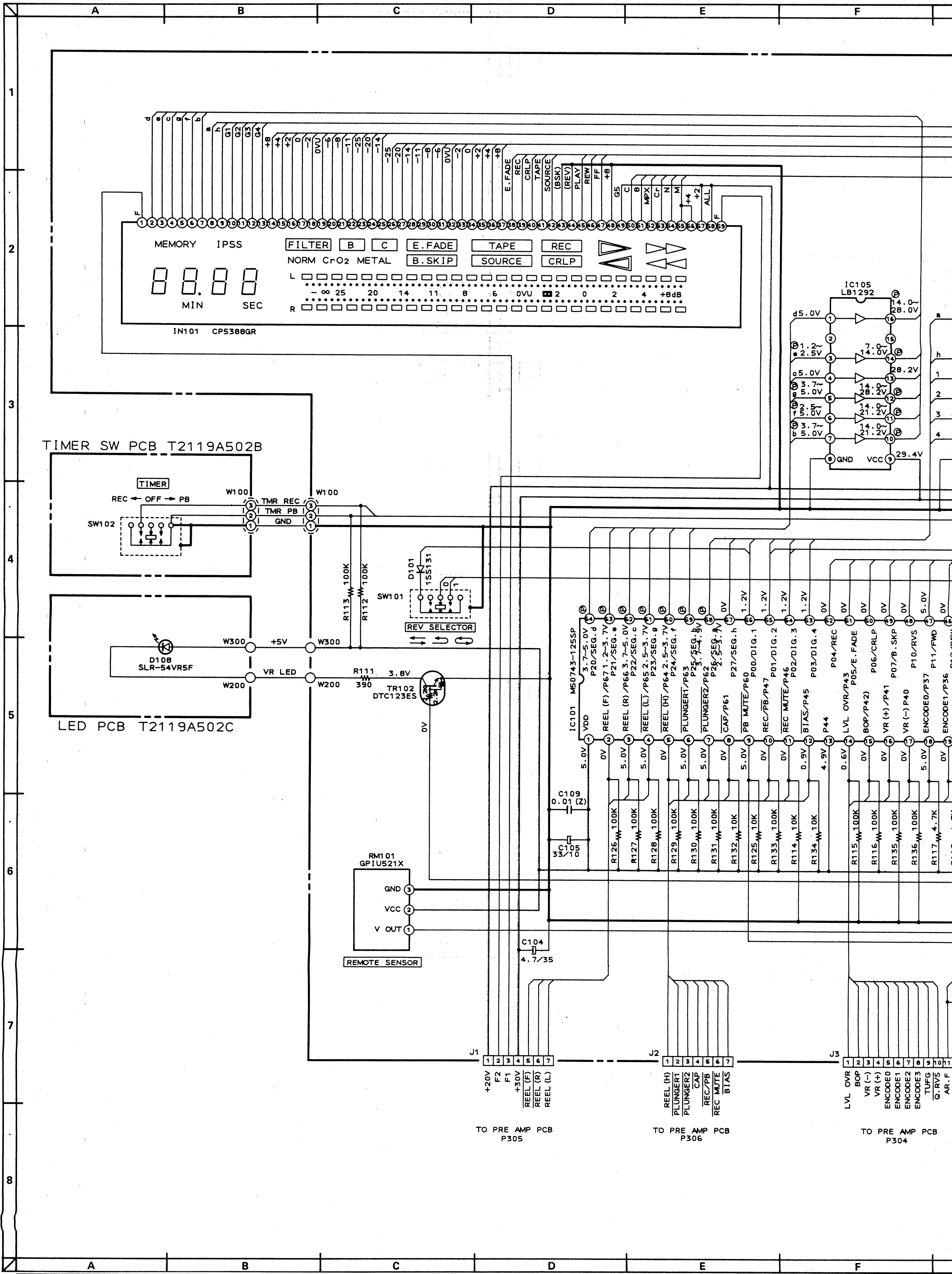

TIMER SW PCB T2119A502B

LED PCB T2119A502C

TO PRE AMP PCB P305

TO PRE AMP PCB P306

TO PRE AMP PCB P304

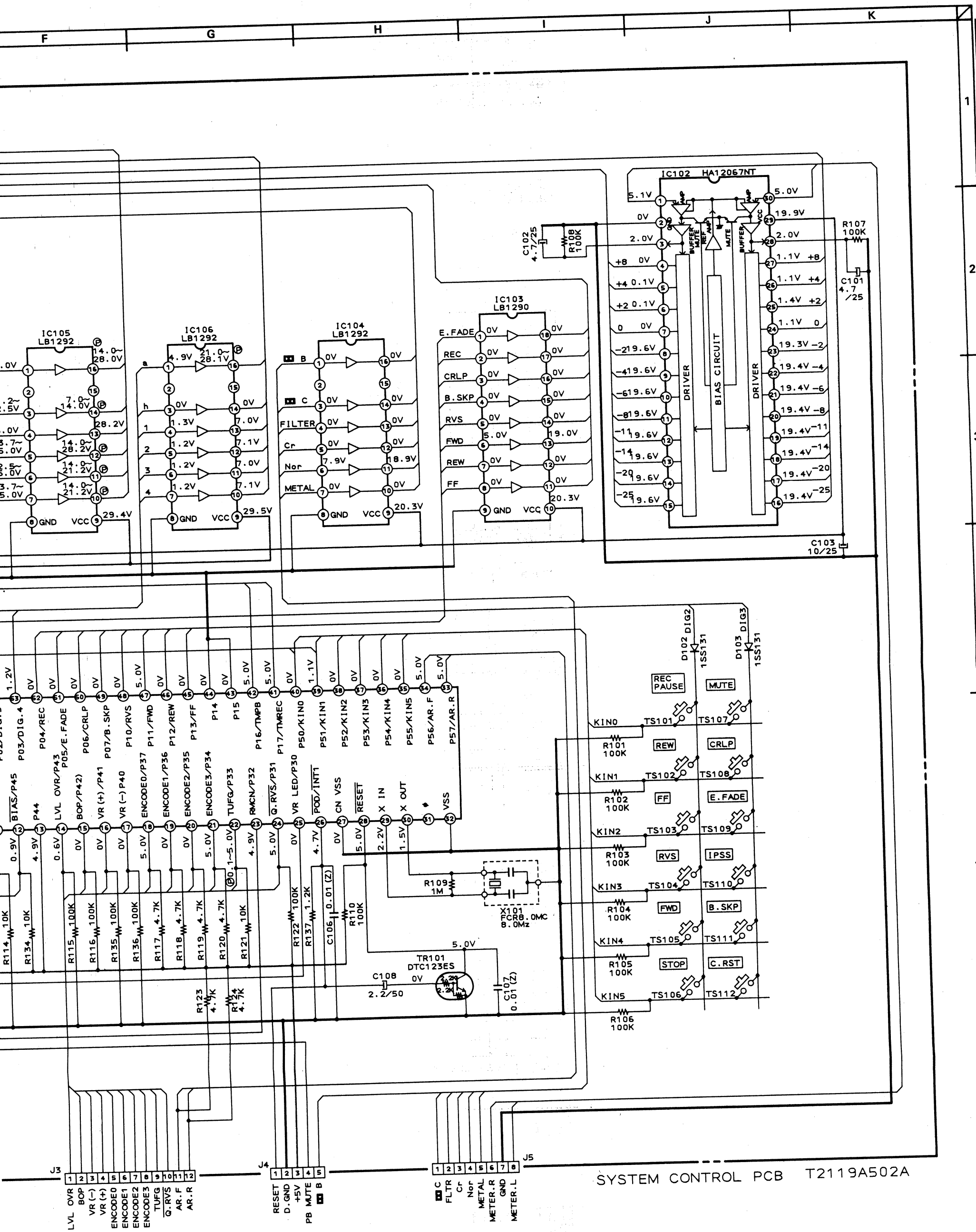

SYSTEM CONTROL PCB T2119A502A

GX-R35
SYSTEM CONTROL
SCHEMATIC DIAGRAM
NO. 3-3 T211905M

NOTE
UNLESS OTHERWISE SPECIFIED
ALL RESISTORS IN OHMS 1/6W(J)
ALL CAPACITORS IN μF50W(J)

1
2
3
4
5
6
7
8

F G H I J K

F G H I J K

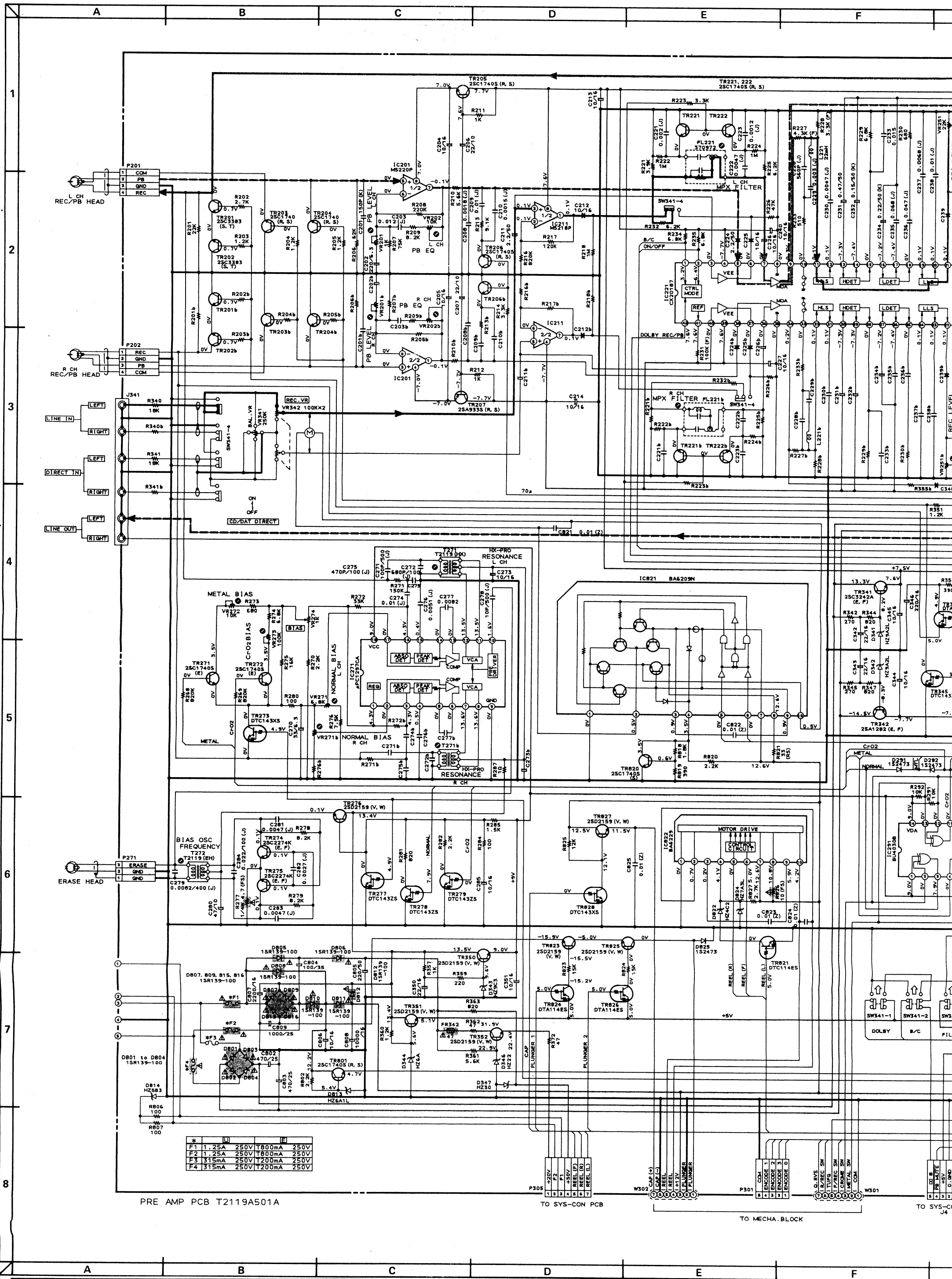

PRE AMP PCB T2119A501A

* F	U	I	P
F1	1.25A	250V	T800mA 250V
F2	1.25A	250V	T800mA 250V
F3	315mA	250V	T200mA 250V
F4	315mA	250V	T200mA 250V

TO SYS-CON PCB

TO MECHA. BLOCK

TO SYS-CC J4

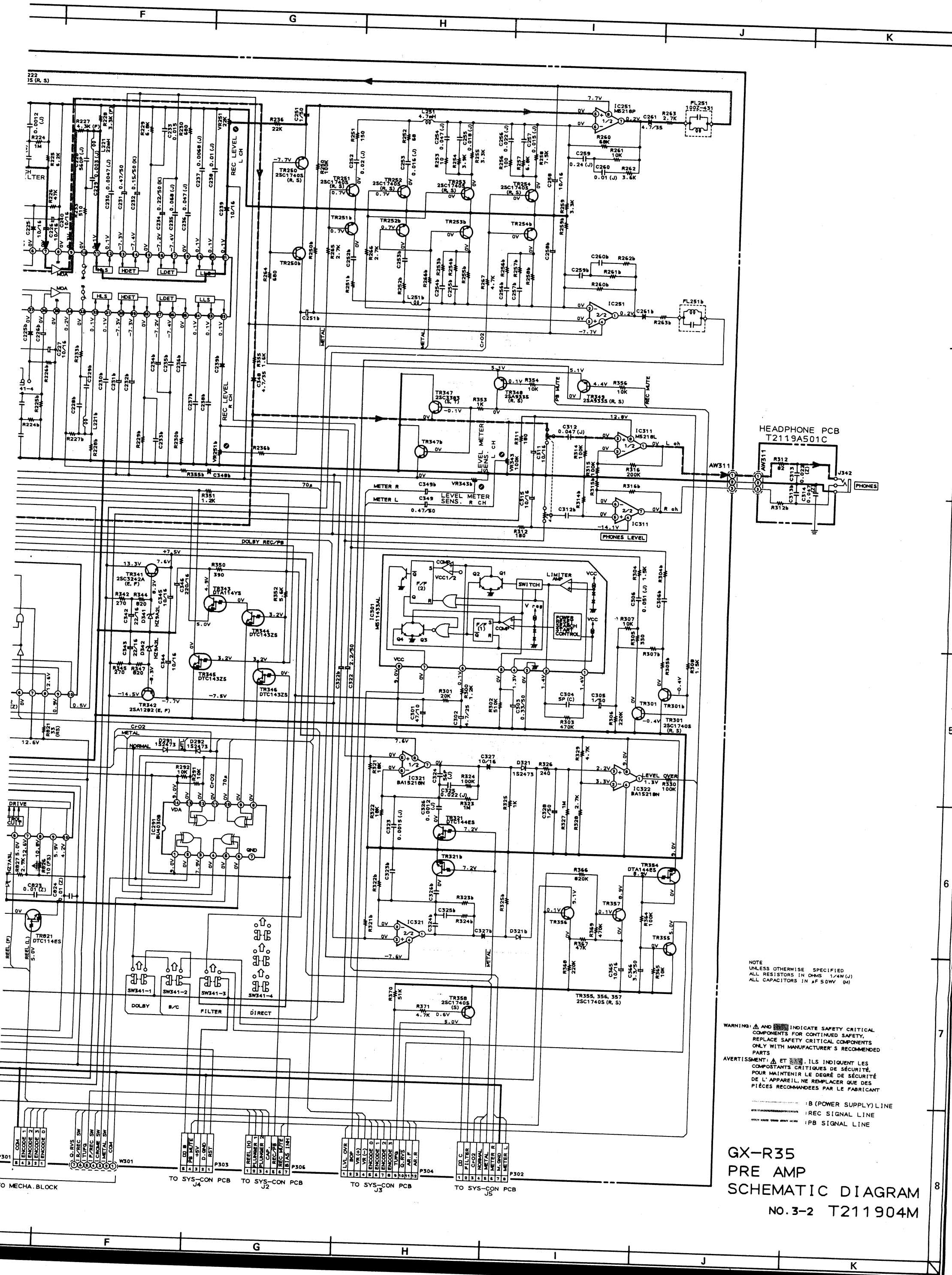

NOTE
UNLESS OTHERWISE SPECIFIED
ALL RESISTORS IN OHMS 1/4W (J)
ALL CAPACITORS IN μF 50V (M)

WARNING: ⚠ AND ⚡ INDICATE SAFETY CRITICAL COMPONENTS FOR CONTINUED SAFETY. REPLACE SAFETY CRITICAL COMPONENTS ONLY WITH MANUFACTURER'S RECOMMENDED PARTS.

AVERTISSEMENT: ⚠ ET ⚡ ILS INDICENT LES COMPOSANTS CRITIQUES DE SÉCURITÉ. POUR MAINTENIR LE DEGRÉ DE SÉCURITÉ DE L'APPAREIL, NE REMPLACER QUE DES PIÈCES RECOMMANDÉES PAR LE FABRICANT.

--- PB (POWER SUPPLY) LINE
 --- REC SIGNAL LINE
 --- PB SIGNAL LINE

**GX-R35
PRE AMP
SCHEMATIC DIAGRAM
NO.3-2 T211904M**

T 2119A501A

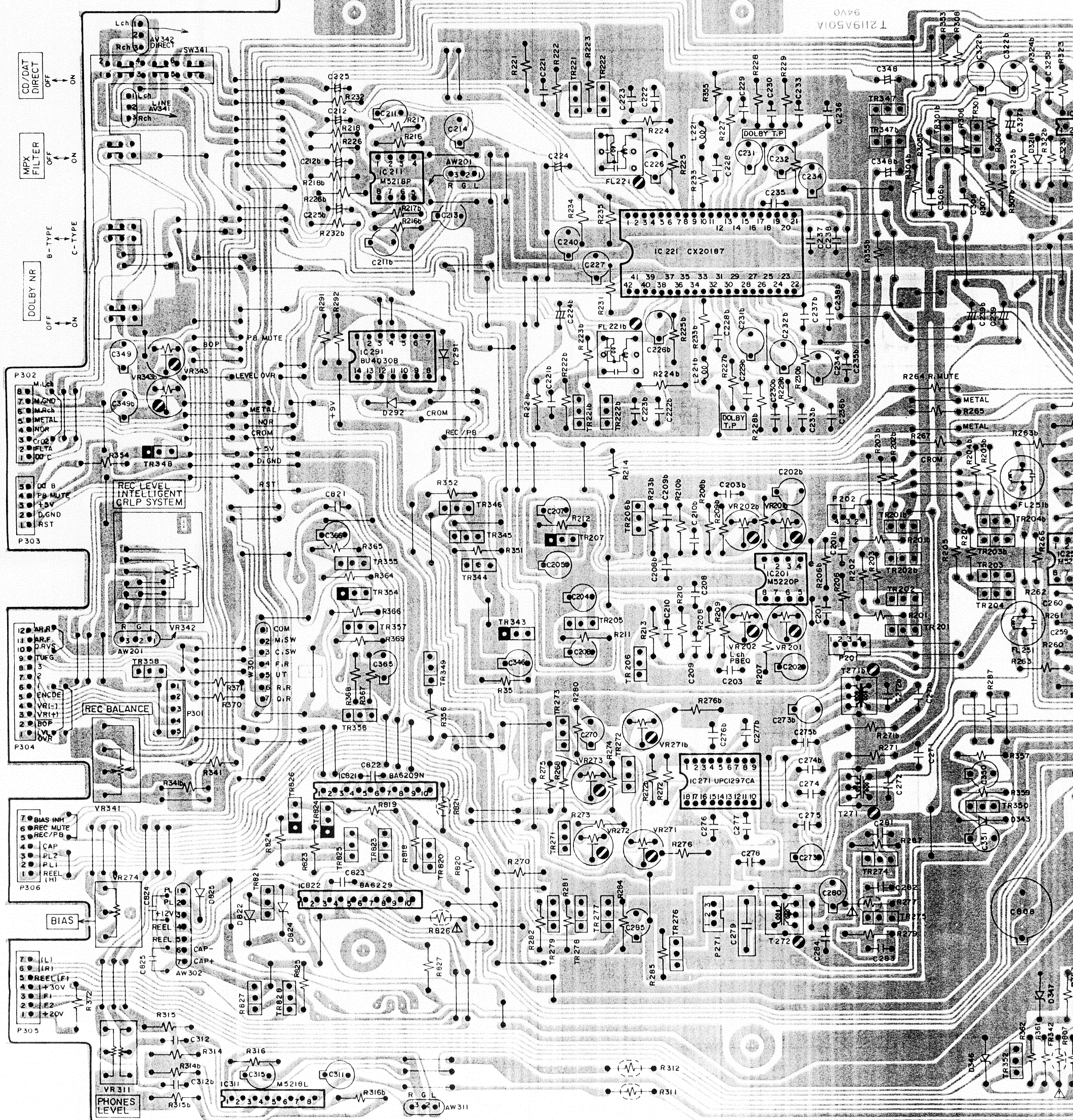

PRE AMP PCB T2119A501A

WARNING: ⚠ INDICATES SAFETY CRITICAL
 REPLACE SAFETY CRITICAL
 RECOMMENDED PARTS

AVERTISSEMENT: ⚠ IL INDIQUE LES CO
 POUR MAINTENIR LE DEGRÉ
 NE REMPLACER QUE DES PI



PRINCIPAL PARTS LOCATION

IC	TRANSISTOR
IC201.....D4	TR201.....C,D3,C,D4
IC211.....F1	TR202.....C,D4
IC221.....D,E2	TR203.....C4
IC251.....B,C3,4	TR204.....C4,C3
IC271.....D,E5	TR205.....E4
IC291.....F2,3	TR206.....E3,E4
IC311.....G6	TR207.....E3
IC321.....B,C1	TR221.....E1,E3
IC322.....A1	TR222.....E1,E3
IC358.....G,H4	TR250.....A3,A4
IC821.....F,G5	TR251.....B3,B4
IC822.....F,G5	TR252.....B3,B4
	TR253.....B3,B4
	TR254.....B3,B4
	TR271.....E5
	TR272.....E5
	TR273.....E4,5
	TR274.....D5
	TR275.....D5
	TR276.....E5
	TR277.....E5,6
	TR278.....E5,6
	TR279.....E5,6
	TR301.....C1
	TR321.....A1,B1
	TR341.....B2
	TR342.....B2
	TR343.....E,F4
	TR344.....F4
	TR345.....F3
	TR346.....F3
	TR347.....C,D1
	TR348.....G,H3
	TR349.....F4
	TR350.....C5
	TR351.....A5
	TR352.....C6
	TR354.....F4
	TR355.....F4
	TR356.....F4
	TR357.....F4
	TR358.....G,H4
	TR801.....A5
	TR820.....F5
	TR821.....G5
	TR823.....F5
	TR824.....G5
	TR825.....F5
	TR826.....G5
	TR827.....G5
	TR828.....G5

CONNECTOR

AW201.....F1,H4
AW301.....G4
AW302.....G5,6
AW311.....F6,A1
AW341.....H1,A2
AW342.....H1,A2
P301.....G4
P302.....H3
P303.....H3
P304.....H4
P305.....H6
P306.....H5

= NPN TRANSISTOR
 = PNP TRANSISTOR

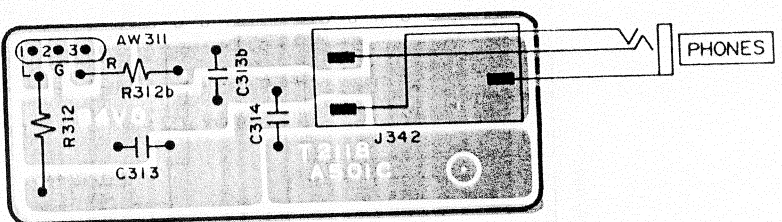

HEADPHONE PCB
T2119A501C

WARNING: ⚠ INDICATES SAFETY CRITICAL COMPONENTS FOR CONTINUED SAFETY. REPLACE SAFETY CRITICAL COMPONENTS ONLY WITH MANUFACTURER'S RECOMMENDED PARTS.
 AVERTISSEMENT: ⚠ IL INDIQUE LES COMPOSANTS CRITIQUES DE SÉCURITÉ. POUR MAINTENIR LE DEGRÉ DE SÉCURITÉ DE L'APPAREIL, NE REMPLACER QUE DES PIÈCES RECOMMANDÉES PAR LE FABRICANT.

T2119A501A

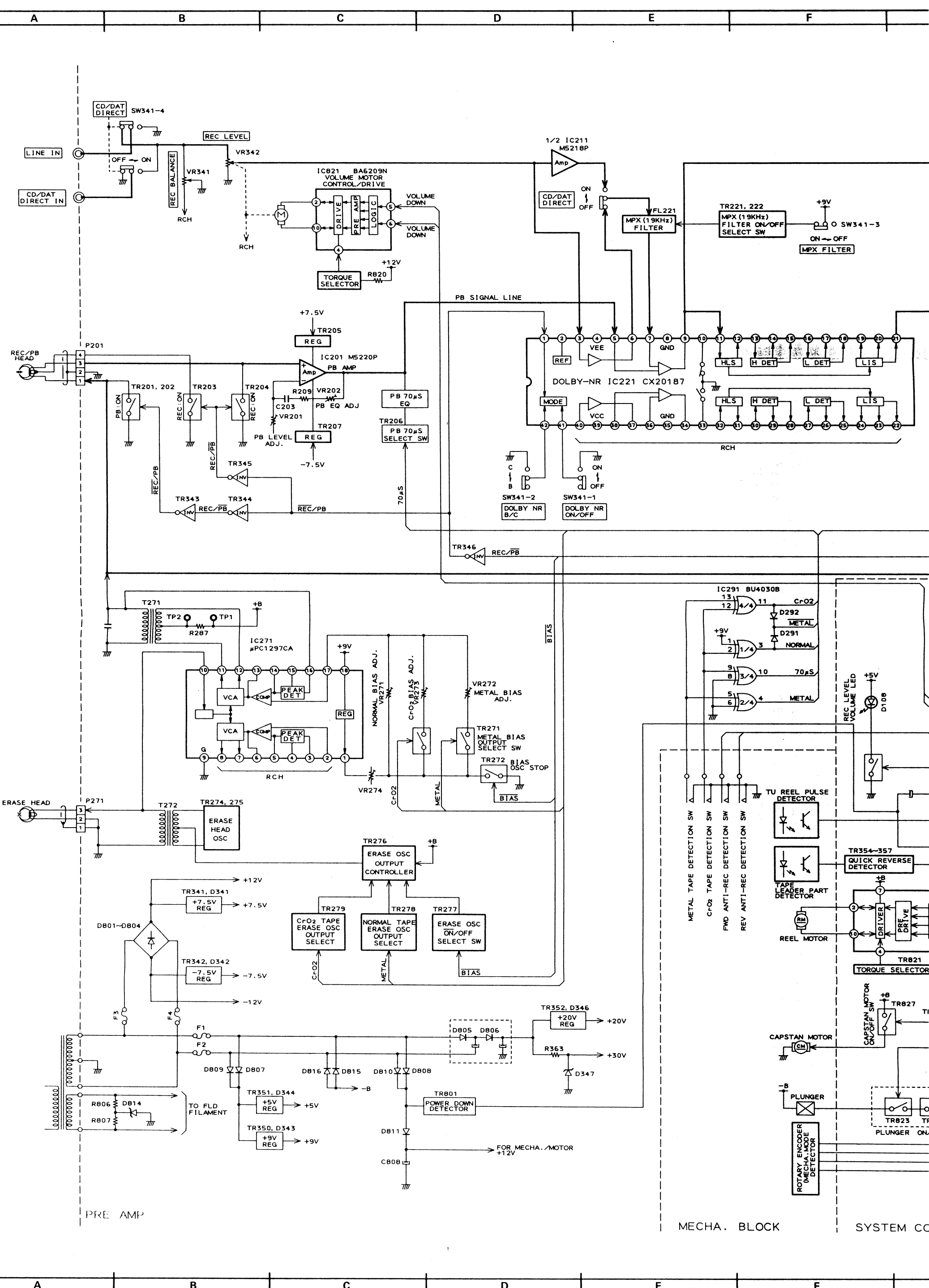

PRE AMP

MECHA. BLOCK

SYSTEM CC

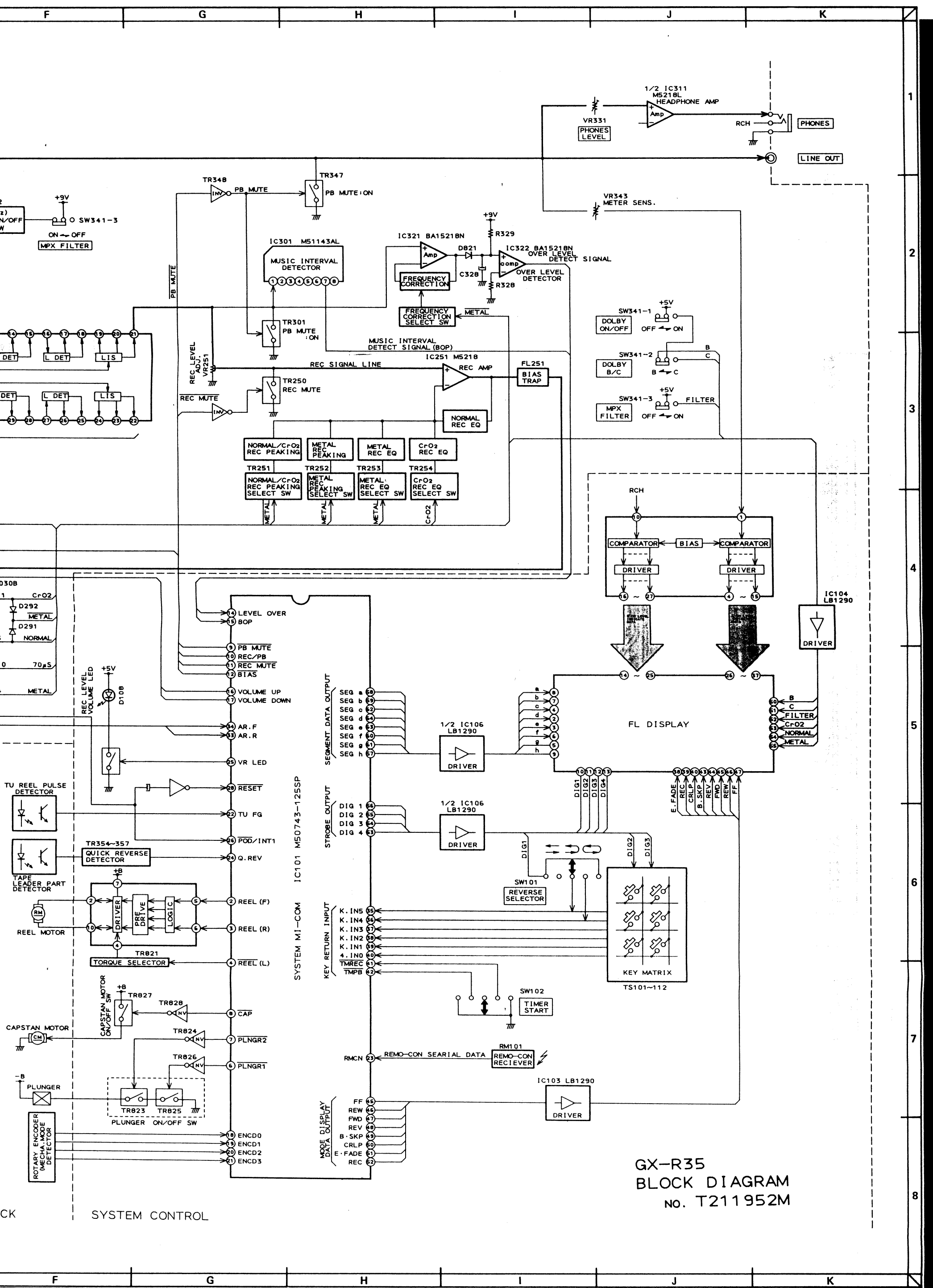

GX-R35
BLOCK DIAGRAM
No. T211952M

M50743-125SP (SYSTEM CONTROL MI-COM)

Pin No.	Symbol	I/O	Functions
1	VDD		+5 V
2	REEL (F)	O	Reel motor control output. L: Normal (FWD) direction
3	REEL (R)	O	Reel motor control output. L: Reverse (REV) direction
4	REEL (L)	O	Reel motor torque (Low) control output. H: PLAY, REC PLAY, REC MUTE
5	REEL (H)	O	Reel motor torque (High) control output. H: F.FWD, REW
6	PLUNGER 1	O	Plunger 1 ON/OFF control. L: Plunger ON
7	PLUNGER 2	O	Plunger 2 ON/OFF control. L: Plunger ON
8	CAP	O	Capstan motor ON/OFF control output. L: Capstan motor ON
9	PB MUTE	O	Playback mute control output. L: Playback mute ON
10	REC/PB	O	Record/playback mode select output. H: REC, L: Play
11	REC MUTE	O	Recording mute control output. L: Recording mute ON
12	BIAS	O	Bias oscillation ON/OFF control. L: ON
13	P44		Not used
14	LVL OVR	I	Level over detection signal input. H: Level over
15	BOP	I	Music interval detection signal input. H: Music interval
16	VR (+)	O	REC level volume (increase) control output. H: ON
17	VR (-)	O	REC level volume (decrease) control output. H: ON
18	ENCODE 0	I	Data input from mecha. mode detection rotary encoder.
19	ENCODE 1		
20	ENCODE 2		
21	ENCODE 3		
22	TU FG	I	Reel pulse input.
23	RMCN	I	Serial data input from remote control unit.
24	Q RVS	I	Quick reverse detection signal input.
25	VR LED	O	LED ON/OFF control output.
26	POD/INT 1	I	Power down detection signal input.
27	Vss		GND
28	RESET		Reset control input
29	X in	I	Clock OSC crystal connection terminal.
30	X out	O	
31			Not used
32	Vss		GND
33	AR.R	I	Anti reverse recording detection input. H: reverse recording inhibition.
34	AR.F	I	Anti forward recording detection input. H: forward recording inhibition.
35	K IN 5	I	Key return data input from key matrix.
36	K IN 4		
37	K IN 3		
38	K IN 2		
39	K IN 1		
40	K IN 0		
41	TM REC	I	Timer recording mode select control input. L: Timer recording mode.
42	TM PB	I	Timer playback mode select control input. L: Timer playback mode.
43	P15		GND
44	P14		GND
45	FF	O	▶▶ indicator control output.
46	REW	O	◀◀ indicator control output.
47	FWD	O	▶ indicator control output.
48	REV	O	◀ indicator control output.
49	B SKP	O	B.SKP indicator control output.
50	CRLP	O	CRLP indicator control output.
51	E.FADE	O	E.FADE indicator control output.
52	REC	O	REC indicator control output.
53	DIG 4	O	Digit data output.
54	DIG 3		
55	DIG 2		
56	DIG 1		
57	SEG h	O	MEMO/IPSS indicator select output.
58	SEG a	O	Segment data output.
59	SEG b		
60	SEG f		
61	SEG g		
62	SEG c		
63	SEG e		
64	SEG d		