

RE32

MULTITRACK REMOTE CONTROLLER

Operator's Manual



WARNING

To prevent fire or shock hazard, do not expose this appliance to rain or moisture.

Important Notice

The material in this document is copyright to AKAI professional M.I. Corp., and may not be quoted or reproduced in any form without written permission from the company.

LIMITED SOFTWARE WARRANTY POLICY

All the software provided with, or purchased especially for, AKAI professional products has been tested for functionality. AKAI professional M.I. Corp. will make its best efforts to correct reported software defects for future releases subject to technical practicabilities.

AKAI professional M.I. Corp. makes no warranty or representation either expressed or implied with respect to the system's performance or fitness for a particular purpose.

In no event will AKAI professional M.I. Corp. be liable for direct or indirect damages arising from any defect in the software or its documentation. Further, AKAI professional M.I. Corp. will not accept any liability for any programs, sounds, audio recording or sequences stored in or used with AKAI professional products, including the cost of recovery of such data.

The warranties, remedies and disclaimers above are exclusive and take precedence over all others, oral or written, express or implied, to the extent permitted by law in the geographical area of the product's use. No employee of AKAI professional M.I. Corp., agent, distributor or employee of an agent or distributor is authorised to offer any variation from this policy.

WARNING!!

To prevent fire or shock hazard, do not expose this appliance to rain or moisture.

1-En

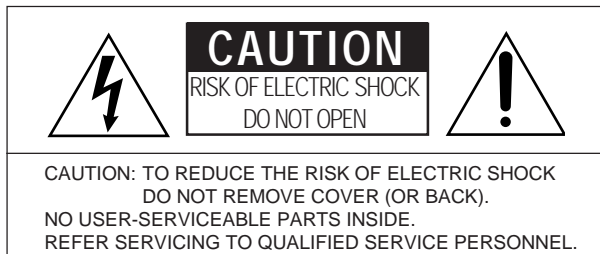

THE SYMBOLS ARE RULED BY UL STANDARDS (U.S.A.)

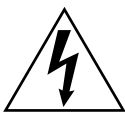

The lightning flash with arrowhead symbol, within an equilateral triangle, is intended to alert the user to the presence of uninsulated "dangerous voltage" within the product's enclosure; that may be of sufficient magnitude to constitute a risk of electric shock to persons.



The exclamation point within an equilateral triangle is intended to alert the user to the presence of important operating and maintenance (servicing) instructions in the literature accompanying the appliance.

5B-En

WARNING

WARNING

The RE32 is designed to be used in a standard household environment. Power requirements for electrical equipment vary from area to area. Please ensure that your RE32 meets the power requirements in your area. If in doubt, consult a qualified electrician or AKAI professional dealer.

120VAC	@ 60Hz for USA and Canada
220-230/240VAC	@ 50Hz for Europe
240VAC	@ 50Hz for Australia

PROTECTING YOURSELF AND THE RE32

- Never touch the AC plug with wet hands.
- Always disconnect the RE32 from the power supply by pulling on the plug, not the cord.
- Allow only an AKAI professional dealer or qualified professional engineer to repair or reassemble the RE32. Apart from voiding the warranty, unauthorized engineers might touch live internal parts and receive a serious electric shock.
- Do not put, or allow anyone to put any object, especially metal objects, into the RE32.
- Use only a household AC power supply. Never use a DC power supply.
- If water or any other liquid is spilled into or onto the RE32, disconnect the power, and call your dealer.
- Make sure that the unit is well-ventilated, and away from direct sunlight.
- To avoid damage to internal circuitry, as well as the external finish, keep the RE32 away from sources of direct heat (stoves, radiators, etc.).
- Avoid using aerosol insecticides, etc. near the RE32. They may damage the surface, and may ignite.
- Do not use denaturated alcohol, thinner or similar chemicals to clean the RE32. They will damage the finish.
- Modification of this equipment is dangerous, and can result in the functions of the RE32 being impaired. Never attempt to modify the equipment in any way.
- In order to assure optimum performance of your RE32, select the setup location carefully, and make sure the equipment is used properly. Avoid setting up the RE32 in the following locations:
 1. In a humid or dusty environment
 2. In a room with poor ventilation
 3. On a surface which is not horizontal
 4. Inside a vehicle such as a car, where it will be subject to vibration
 5. In an extremely hot or cold environment

WARNING
THIS APPARATUS MUST BE EARTHED
IMPORTANT

This equipment is fitted with an approved non-rewireable UK mains plug.

To change the fuse in this type of plug proceed as follows:

- 1) Remove the fuse cover and old fuse.
- 2) Fit a new fuse which should be a BS1362 5 Amp A.S.T.A or BSI approved type.
- 3) Refit the fuse cover.

If the AC mains plug fitted to the lead supplied with this equipment is not suitable for your type of AC outlet sockets, it should be changed to an AC mains lead, complete with moulded plug, to the appropriate type. If this is not possible, the plug should be cut off and a correct one fitted to suit the AC outlet. This should be fused at 5 Amps.

If a plug without a fuse is used, the fuse at the distribution board should NOT BE GREATER than 5 Amp.

PLEASE NOTE: THE SEVERED PLUG MUST BE DESTROYED TO AVOID A POSSIBLE SHOCK HAZARD SHOULD IT BE INSERTED INTO A 13 AMP SOCKET ELSEWHERE.

The wires in this mains lead are coloured in accordance with the following code:

GREEN and YELLOW	— EARTH
BLUE	— NEUTRAL
BROWN	— LIVE

As the colours of the wires in the mains lead of this apparatus may not correspond with the coloured markings identifying the terminals in your plug, please proceed as follows:

The wire which is coloured GREEN and YELLOW must be connected to the terminal which is marked with the letter E or with the safety earth symbol \equiv or coloured GREEN or coloured GREEN and YELLOW.

The wire which is coloured BLUE must be connected to the terminal which is marked with the letter N or coloured BLACK.

The wire which is coloured BROWN must be connected to the terminal which is marked with the letter L or coloured RED.

THIS APPARATUS MUST BE EARTHED

Ensure that all the terminals are securely tightened and no loose strands of wire exist.

Before replacing the plug cover, make certain the cord grip is clamped over the outer sheath of the lead and not simply over the wires.

6D-En

FCC WARNING

This equipment has been tested and found to comply with the limits for a Class B digital device pursuant to Part 15 of the FCC rules. These limits are designed to provide reasonable protection against harmful interference in a residential installation. This equipment generates, uses, and can radiate radio frequency energy and, if not installed and used in accordance with the instructions, may cause harmful interference to radio communications. However, there is no guarantee that interference will not occur in a particular installation. If this equipment does cause harmful interference to radio or television reception, which can be determined by turning the equipment off and on, the user is encouraged to try to correct the interference by one or more of the following measures:

- Reorient or relocate the receiving antenna.
- Increase the separation between the equipment and receiver.
- Connect the equipment into an outlet on a circuit different from that to which the receiver is connected.
- Consult the dealer or an experienced radio/TV technician for help.

21B-En

CHANGES OR MODIFICATIONS NOT EXPRESSLY APPROVED BY THE MANUFACTURER FOR COMPLIANCE COULD VOID THE USER'S AUTHORITY TO OPERATE THE EQUIPMENT.

32-En

AVIS POUR LES ACHETEURS CANADIENS DU RE32

Le présent appareil numérique n'émet pas des bruits radioélectriques dépassant les limites applicables aux appareils numériques de la Class B prescrites dans le Règlement sur le brouillage radioélectrique édicté par le ministère des Communications du Canada

27-F

This digital apparatus does not exceed the Class B limits for radio noise emissions from digital apparatus set out in the Radio Interference Regulations of the Canadian Department of Communications.

27-En

VENTILATION

Do not prevent the unit's ventilation, especially by placing the unit on the soft carpet, in a narrow space, or by placing objects on the unit's chassis—top, side, or rear panels. Always keep the unit's chassis at least 10 centimeters from any other objects.

31C-En

COPYRIGHT NOTICE

The AKAI RE32 is a computer-based device, and as such contains and uses software in ROMs. This software, and all related documentation, including this Owner's Manual, contain proprietary information which is protected by copyright laws. All rights are reserved. No part of the software or its documentation may be copied, transferred or modified. You may not modify, adapt, translate, lease, distribute, resell for profit or create derivative works based on the software and its related documentation or any part thereof without prior written consent from AKAI professional M.I. Corp., Yokohama, Japan.

WARRANTY

AKAI professional M.I. Corp. warrants its products, when purchased from an authorized AKAI professional dealer, to be free from defects in materials and workmanship for a period of 12 (twelve) months from the date of purchase. Warranty service is effective and available to the original purchaser only, and only on completion and return of the AKAI professional Warranty Registration Card within 14 days of purchase.

Warranty coverage is valid for factory-authorized updates to AKAI professional instruments and their software, when their installation is performed by an authorized AKAI professional Service Centre, and a properly completed Warranty Registration has been returned to your AKAI professional dealer.

To obtain service under this warranty, the product must, on discovery of the defect, be properly packed and shipped to the nearest AKAI professional Service Centre. The party requesting warranty service must provide proof of original ownership and date of purchase of the product.

If the warranty is valid, AKAI professional will, without charge for parts or labour, either repair or replace the defective part(s). Without a valid warranty, the entire cost of the repair (parts and labour) is the responsibility of the product's owner.

AKAI professional warrants that it will make all necessary adjustments, repairs and replacements at no cost to the original owner within 12 (twelve) months of the purchase date if:

- 1 The product fails to perform its specified functions due to failure of one or more of its components.
- 2 The product fails to perform its specified functions due to defects in workmanship.
- 3 The product has been maintained and operated by the owner in strict accordance with the written instructions for proper maintenance and use as specified in this Operator's Manual.

Before purchase and use, owners should determine the suitability of the product for their intended use, and the owner assumes all risk and liability whatsoever in connection therewith. AKAI professional shall not be liable for any injury, loss or damage, direct or consequential, arising out of the use, or inability to use the product.

The warranty provides only those benefits specified, and does not cover defects or repairs needed as a result of acts beyond the control of AKAI professional, including, but not limited to:

- 1 Damage caused by abuse, accident or negligence. AKAI professional will not cover under warranty any original factory disk damaged or destroyed as a result of the owner's mishandling.
- 2 Damage caused by any tampering, alteration or modification of the product: operating software, mechanical or electronic components.
- 3 Damage caused by failure to maintain and operate the product in strict accordance with the written instructions for proper maintenance and use as specified in this Operator's Manual.
- 4 Damage caused by repairs or attempted repairs by unauthorized persons.
- 5 Damage caused by fire, smoke, falling objects, water or other liquids, or natural events such as rain, floods, earthquakes, lightning, tornadoes, storms, etc.
- 6 Damage caused by operation on improper voltages.

IMPORTANT NOTE: This warranty becomes void if the product or its software is electronically modified, altered or tampered with in any way.

AKAI professional shall not be liable for costs involved in packing or preparing the product for shipping, with regard to time, labour or materials, shipping or freight costs, or time and expenses involved in transporting the product to and from an AKAI professional Authorized Service Centre or Authorized Dealer.

AKAI professional will not cover under warranty an apparent malfunction that is determined to be user error, or the owner's inability to use the product.

THE DURATION OF ANY OTHER WARRANTIES, WHETHER IMPLIED OR EXPRESS, INCLUDING BUT NOT LIMITED TO THE IMPLIED CONDITION OF MERCHANTABILITY, IS LIMITED TO THE DURATION OF THE EXPRESS WARRANTY HEREIN.

AKAI professional hereby excludes incidental or consequential damages, including but not limited to:

- 1 Loss of time
- 2 Inconvenience
- 3 Delay in performance of the Warranty
- 4 The loss of use of the product
- 5 Commercial loss
- 6 Breach of any express or implied warranty, including the Implied Warranty of Merchantability, applicable to this product

INTRODUCTION	1
FEATURES	1
ABOUT THIS MANUAL	2
TERMINOLOGY	3
MULTI-MACHINESYSTEM	5
REAR PANEL	6
SYSTEM CONNECTIONS	7
SETTING MACHINE ID NUMBERS	8
SETTING MACHINE ID NUMBERS - DR16pro	8
SETTING MACHINE ID NUMBERS - DD8	8
POWERING UP THE RE32 SYSTEM	9
RE32 PANEL LAYOUT	10
VGA DISPLAY	12
NAVIGATING THE RE32	15
CURSOR KEYS	15
GETTING AROUND A PROJECT	21
GETTING STARTED - BASIC CONCEPTS	24
CUE	24
EDIT REGION	24
SELECT Q	24
BASIC SYSTEM SETTINGS	26
FORMATTING DISKS	28
VGA SETUP	31
RECORDING	35
BASIC RECORDING	35
ADVANCED RECORDING	37
RECORD DISKS	40
RECORD TYPE	41
RECORD SETUP	43
AUTO PUNCH-IN/OUT	46
REHEARSE	46
INPUT ROUTING - ASSIGNING INPUTS TO TRACKS	47
INPUT ROUTING - DR16pro	48
INPUT ROUTING - DD8 (or DD8plus)	49
INPUT ROUTING - DD1500	50
RECORDING DIGITALLY	52
PLAYING BACK AUDIO MATERIAL	54
GROUPING TRACKS	57
AUTOLOCATOR	57
LOCATING TO THE START OR END OF A PROJECT	57
LOCATING TO THE NEXT OR PREVIOUS CUES	57
LOCATING TO TIMECODE POSITIONS	57
LOCATING TO LOCATOR MEMORIES	57
STORING LOCATE MEMORIES	57
CLEARING LOCATE MEMORIES	58
CLEARING SINGLE LOCATE MEMORIES	58
CLEARING ALL LOCATE MEMORIES	58
CYCLE	59
PRE-ROLL	60
EDITING	61
EDIT KEY	61
EXIT KEY	61
UNDO KEY	61
REDO (SHIFT+UNDO)	61
EXECUTE KEY	61
IN KEY	61
SYNC KEY	61

OUT KEY	61
TO SELECT A WHOLE TRACK	62
TO SELECT A TRACK FROM THE IN POINT TO THE END	62
TO SELECT A TRACK FROM THE OUT POINT TO THE START	63
TO SELECT A TRACK FROM THE SYNC MARK TO THE START OR END	63
SELECT Q KEY	63
MULTI- MACHINE EDIT	64
COPYING A REGION	64
MULTITRACK PASTE	66
MULTITRACK INSERT	66
MULTITRACK OVERLAY	67
CUT	68
ERASE	68
DISCARD	68
SPLIT EDIT	69
SINGLE MACHINE EDIT	70
EDIT CLIPBOARD	70
COPY TO CLIPBOARD	72
CUT TO CLIPBOARD	74
CUT FORWARDS TO CLIPBOARD (SHIFT+CUT)	75
ERASE TO CLIPBOARD	76
DISCARD	77
PASTE FROM CLIPBOARD	78
PASTING TO OUT AND SYNC REFERENCES	79
INSERT FROM CLIPBOARD	80
INSERTING TO OUT AND SYNC REFERENCES	81
OVERLAY FROM CLIPBOARD	82
OVERLAYING TO OUT AND SYNC REFERENCES	82
MOVE REGION	83
NUDGING IN/SYNC/OUT TIMES	84
NUDGING AUDIO	84
UNDOING A NUDGE	85
NUDGE SET (SHIFT+NUDGE)	85
SPLIT CUE	86
IN->NOW (SHIFT+IN)	87
EDIT PLAY KEYS	90
SELECT CUE/EDIT CUE	91
USING EDIT CUE TO AFFECT MULTIPLE CUES	94
CROSSFADE TOOLS	95
DISK MANAGEMENT	98
SAVING PROJECTS	98
SAVING A PROJECT WITH A DIFFERENT NAME	101
SAVING LOCATOR MEMORIES OR OTHER SETTINGS	101
LOAD	102
CREATING A NEW PROJECT	104
DISK UTILITIES	105
DISK INFO	105
DISK DIRECTORY	106
COPYING FILES/DISKS	107
DELETE FILES	111
RENAMING FILES	112
BACKING UP YOUR WORK	113
BACKING UP TO SCSI TAPE DRIVES	113
FORMATTING A TAPE FOR BACKUP	114
BACKING UP SELECTED FILES	116
BACKING UP ALL PROJECTS AND/OR LIBRARIES	117
BACKING UP AN ENTIRE DISK	117
PERFORMING THE BACKUP	118
VERIFYING A BACKUP	120

RESTORING A BACKUP	121
PERFORMING A RESTORE	122
RESTORING THE ENTIRE BACKUP	125
NOTES ABOUT BACKUP/RESTORE	126
SUGGESTIONS FOR BACKUP/RESTORE	127
TAKING CARE OF YOUR TAPE DRIVE	128
ARCHIVING DATA TO DAT	129
RESTORING FROM DAT	132
CLEANUP DISK	133
MINIMISE DISK	134
DISK COMPATIBILITY	136
MACINTOSH	136
PROTOOLS IMPORT	137
CREATING PROTOOLS SESSIONS	138
WAVEFRAME	139
FAIRLIGHT MFX3PLUS	140
MSDOS (FAT16)	140
SYSTEM SETUP	141
SETUP - MULTI	142
DISPLAY	143
DISPLAY OFFSET	144
FOOTAGE DISPLAY	144
RECORD SETUP	145
SPEED	148
TEMPO MAPS	149
CREATING A MIDI TEMPO MAP	150
DELETING TEMPO MAP STEPS	151
LOCATING TO STEPS	151
MORE SETUP FUNCTIONS	152
SAVE SETTINGS	152
LOAD SETTINGS	152
INFO	153
SETUP - SINGLE MACHINE	154
DIGITAL SETTINGS	154
DIGITAL OUTPUT FORMAT	157
OUTPUT DE-EMPHASIS	157
SYNC SETTINGS	158
RECORD SETUP	162
OPERATING LEVELS	162
REMOTE PAGES	163
GPIO SETUP	164
USER KEYS	168
RC15 CONNECTION	170
SYNCING TO EXTERNAL TIMECODE	171
SETTING TIMECODE OFFSETS	172
ADVANCED OFFSETS	173
RS422 MASTER CONTROL	175
LAYBACK FUNCTION IN RS422 MASTER	176
USING THE LAYBACK FUNCTION	177
RS422 MASTER CONTROL OF NON-LINEAR VIDEO RECORDERS	178
SPECIFICATIONS	179
INDEX	180-182

The staff at AKAI professional would like to thank you for buying the RE32 Multi-track Remote Controller. We are confident that the RE32 will be a sound investment, offering many years of reliable service and will be a product you can rely on in your daily work.

The RE32 is designed to be used with Akai DD/DR-Series Hard Disk Recorders (such as the DR16pro, DD8, DD8plus or DD1500) allowing control of up to 128 tracks of audio.

Dedicated track select keys, transport keys and autolocator functions give the RE32 the feel of a conventional MTR whilst access to sophisticated editing functions are also provided allowing you to edit audio quickly and precisely. The jog wheel allows you to 'scrub' audio across all tracks just like reel rocking ordinary tape.

The RE32 is connected to the machines via Ethernet and includes a built-in VGA display capable of displaying metering and scrolling track information for all of the connected machines. A simple but effective colour scheme eliminates eye strain even in prolonged sessions. You will no doubt be pleased to know that the screen you see on the monitor is the only one you work in and there are no multiple, stacked 'windows' to confuse you!

FEATURES

- Traditional recording and monitoring functions
- Dedicated track select keys for easy selection of play, mute, edit and record.
- Large dedicated MTR-style transport keys.
- The weighted jog wheel allows you to 'scrub' audio across all tracks for editing.
- MTR style autolocator with 100 locate memories and 100 'grab' markers.
- Detailed track editing with waveform display.
- Powerful multi-track editing functions,
- LED timecode display
- 248x60 pixel LCD display for parameter settings and function selection.
- PS/2 keyboard input for easy naming of audio takes.
- Custom graphics LSI ensures fast screen re-drawing and updates on any size S-VGA monitor.
- The AKAINET link from the RE32 to the connected machines allows true remote control with virtually no limit on distance.

TRADEMARKS

Digidesign and Protools are registered trademarks of Digidesign and/or Avid Technology, Inc. Macintosh is a registered trademark of Apple Computer Inc. All other trademarks, product and company names are the property of their respective owners.

ABOUT THIS MANUAL

This owner's manual has been written to provide you with the information to get the best from the RE32. Although it hoped that the RE32 is easy enough to use without constant reference to this manual, please take the time to read it in order to understand the system fully. The manual takes you through the available functions from scratch, assuming you have just installed it and you are using it for the first time.

This manual covers all basic functions and operation and, wherever possible, gives hints and tips and application notes. However, because of the diversity of applications in which the RE32 can be used, it is not always possible to cover every application specifically. As such, most descriptions of functions are fairly general unless, however, a certain function has a specific use in a particular application.

The availability of some functions on the RE32 may depend on the facilities provided by the connected machines. For example, the DD8plus provides certain features not available on the DR16pro. This manual will give an indication where certain functions may be unavailable. Please refer to the manuals provided with each machine for further details.

As with any piece of new gear, there is always a bit of new jargon to get to grips with. The RE32 is no exception! What follows, therefore, is a short list of some of the terms you will come across during the course of this manual.

GRID This stands for **GR**aphic **I**nterface **D**isplay and refers to the track display on the external monitor.

PROJECT This contains all your recordings, edited and positioned as required and shown on the GRID. Think of it as a reel of multi-track tape if you like and the GRID as an animated track sheet.

A PROJECT also contains autolocator memories, MIDI tempo maps, etc., and these are all saved with the project. The SYSTEM settings are also saved with the project and when a project is subsequently loaded, the whole system is restored to exactly the status the project was saved in. For example, the tracks selected for playback, editing and/or record, the sample rate, external timecode selection, input routing, etc.. All these will be explained later.

Each connected machine actually has its own PROJECT containing audio tracks on that machine but the RE32 assembles this information for display on the monitor as a single 'multi-track' PROJECT.

NOW TIME In the centre of the GRID are two vertical lines. The centre of these two lines is known as the NOW TIME and the actual NOW time is shown in the display above it (and on the LED timecode display). All work is done with referenced to this NOW time. For example, to select a cue for editing, move it to the NOW time and press SELECT Q. Marking IN times and OUT times and locate memories is also done referenced to the NOW time.

CUE This refers to a piece of audio from its start to its end in the GRID. In this manual, a cue may be referred to as "a stereo cue" - this is actually two mono cues across two (normally adjacent) tracks that make up a 'stereo' cue.

EDIT REGION This refers to the area selected between the IN and the OUT points. A track (or tracks) must be selected for editing and the edit region is highlighted green on the external monitor.

IN TIME This usually refers to the start of an edit. However, the IN TIME is used to set auto punch-in and cycle times as well. It is marked by pressing the IN key located above the jog wheel.

OUT TIME This usually refers to the end of an edit although it is also used to set auto punch-out and cycle times. It is marked by pressing the OUT key located above the jog wheel.

SYNC POINT This is a special marker you can place within an edit region or cue for sync purposes.

MARK POINT This is a special marker intended for Biphase synchronisation. It can be set to define a sync point between audio and film (usually a cross before the first frame).

INTRODUCTION

- LIBRARY** A library is a file created for convenient storage of groups of cues (referred to as 'clips'). For example, a library may contain sound effects, or music cues, etc.. Although the library function is not supported on the RE32, several disk related functions can be used on disks containing library files made on another system.
- MULTI-MODE** Most operations on the RE32 are designed to make the system feel like a single multi-track tape machine even if the tracks are on two or more individual machine. For example, in a system with two DR16pro machines, selecting 'Track 17' on the RE32 will actually select Track 1 on the second machine. This method of operation is referred to in this manual as MULTI-MODE.
- SINGLE-MODE** This refers to an alternate method of operation where each machine is used individually. This may be necessary for configuring the system for more complicated environments.

MULTI-MACHINE SYSTEM

The following shows a typical multi-machine system

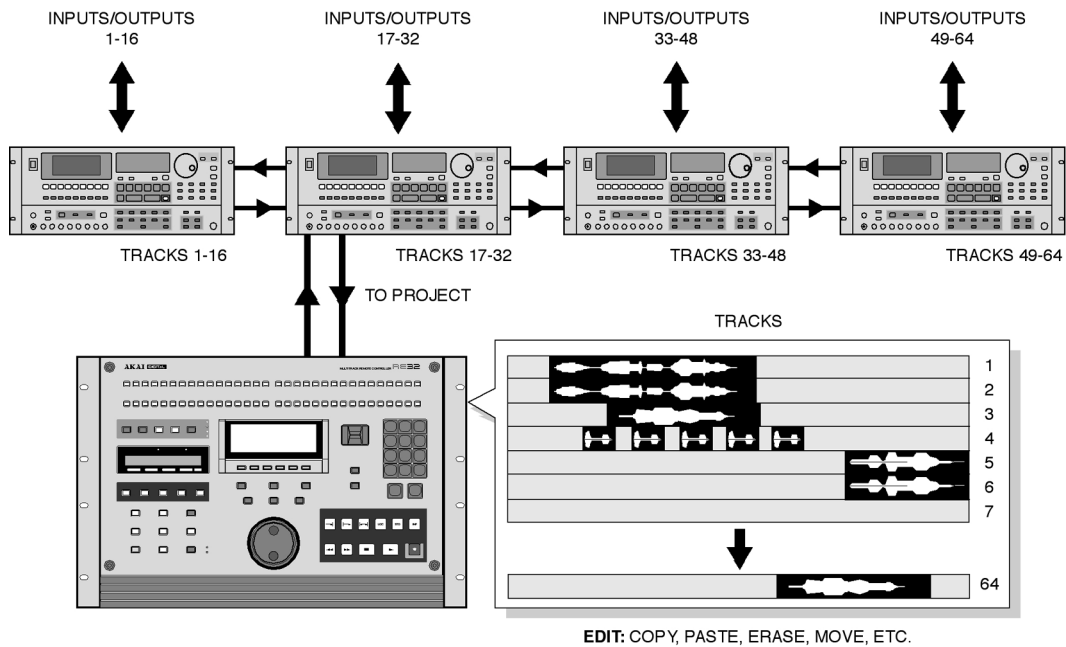

Audio is recorded through the inputs (analogue and/or digital) directly to project tracks on each machine and displayed in the GRID as a multi-track project ready for editing etc.. For example, you may record a long vocal onto track 1, edit out all the mistakes, coughs, breath noises and other unwanted artefacts and simply save the project. You can also copy audio from one region of the project to another region as required.

Audio can be recorded directly into the GRID at the timecode position you want it. That audio may subsequently be edited, crossfaded, etc., as appropriate for the project.

When several machines are connected to the RE32 to expand the total number of tracks available, the system will behave as if there is a single 'multi-track' project encompassing all of these tracks. However, in reality each connected machine maintains its own internal project containing data for the tracks assigned to that machine. Usually, you do not need to worry about the fact that there may be several machines connected as the RE32 will control them as a single 'multi-track' system. However, there may be times when you want to do something specifically on one machine and the RE32 will allow you to do this as well if you wish as explained during the course of this manual.

Of course, your setup need not be as elaborate as the one shown above and an RE32 with just one or two 16-track machines is a powerful combination.

INTRODUCTION

REAR PANEL

In this section, we take a look at the RE32's rear panel connections. Actual operation of the RE32 will be discussed later.

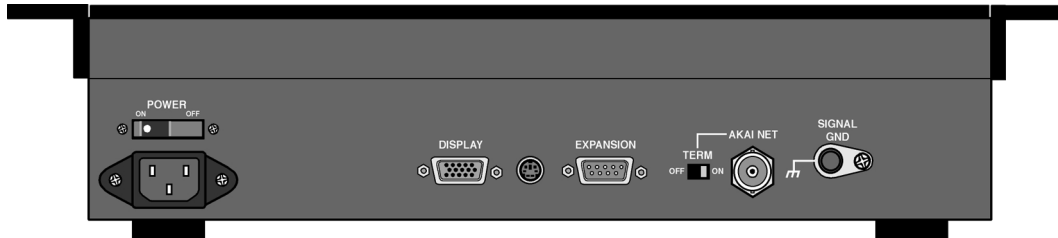

DISPLAY

This connects to any standard S-VGA monitor such as you would use with any PC. You will probably have bought a monitor with the system as supplied by your dealer but, if not, any reputable computer store will be able to sell you one. Any monitor should be able to be used but there are many monitors of different quality available (usually reflected in the price!) and some may not give as good results as others. For example, some may have a particular blue, red or green bias to them, others may not have particularly clear colour contrast and may appear 'hazy' or not have a particularly sharp focus. Other monitors can be sometimes show a faint image of screen items twice resulting in a 'ghostly' image that is difficult to read (especially text). If you are buying a monitor and have any doubts, please contact your dealer who will no doubt be able to recommend a suitable monitor.

Any size monitor may be used and the graphics automatically resize accordingly. You may even use very large RGB monitors but you will need a suitable S-VGA to RGB converter for this. Again, please speak to your dealer for information on choosing and connecting a monitor.

KEYBOARD

This mini DIN socket will accept a PS/2 compatible PC keyboard and is provided to make the naming of files easier.

EXPANSION CONNECTION

This connector is used to attach the optional RC15 User Assignable Remote Controller.

AKAINET

This takes a standard BNC Ethernet cable and is used to connect the RE32 to other machines in the system. You may use the cable provided but, if longer lengths are required, any reputable computer store should sell BNC Ethernet cables in a variety of lengths.

If you choose to use a cable other than the one provided, please make sure it is a high quality one. If there are any problems with the cable or the BNC plugs, you will have communications problems and erratic and unreliable performance.

TERM

This switches termination for the AKAINET connection on or off.

SIGNAL GND

This can be used to overcome ground loops in a complex system.

MAINS INPUT

Mains power is connected here.

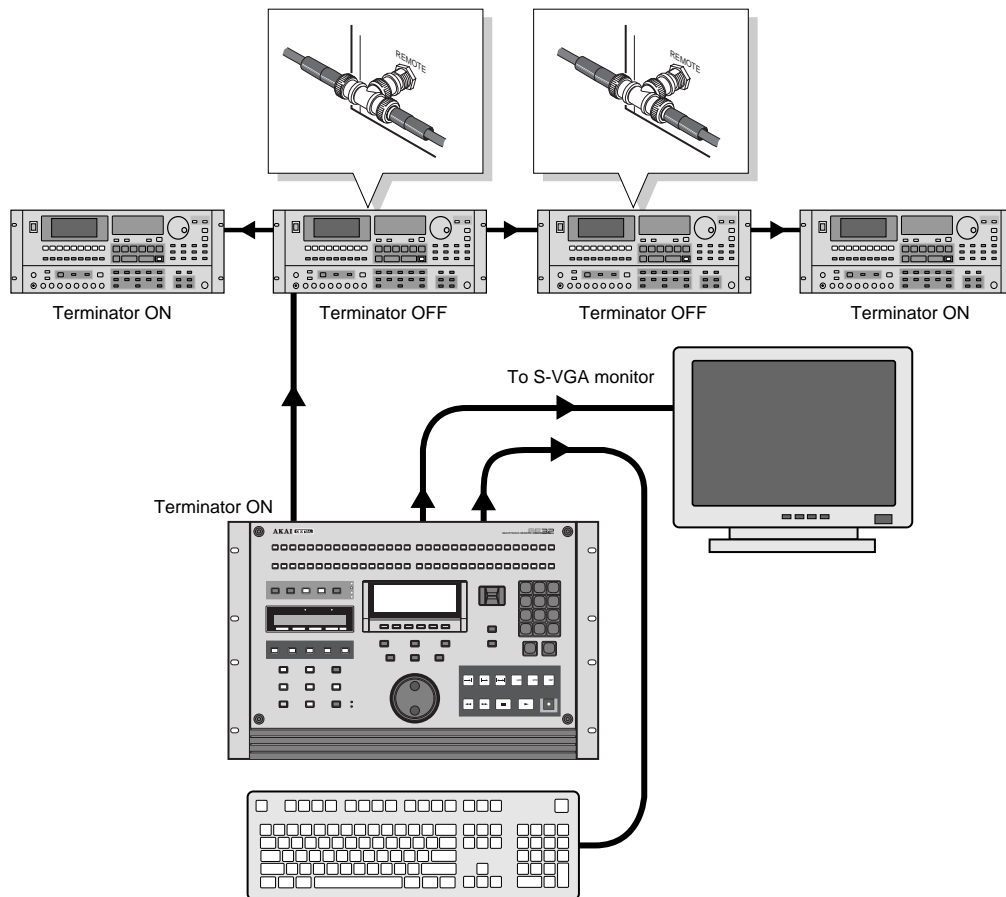

The external monitor is a standard S-VGA colour monitor such as you would use with any PC and any size may be used.

Of course, to this basic system, you may add analogue and/or digital inputs and outputs for use with an external mixer.

If you plan to do a lot of naming of recordings and files, an external PC keyboard is recommended.

All the machines in the system are connected together (and to the RE32) using standard Ethernet BNC cables. These are chained between the AKNET BNC connectors on each machine using BNC 'T' connectors to link each cable (in 16-bit DD8s, an Ethernet option board must be installed).

It is essential that the TERMINATOR switch is switched to the ON position on the first and last units in the chain. Failure to do so will prevent correct communications and the system will not work.

NOTE: The AKNET interface used in the Akai DD/DR system is 10-Base-2 Ethernet. There are certain rules that must be adhered to when setting up the system to ensure reliable operation:

- *All cables should be 50 ohm impedance.*
- *There should be a maximum of 185m of cable in the system between the first and last nodes.*
- *There should be at least 0.5m of cable between each connection.*

INTRODUCTION

SETTING MACHINE ID NUMBERS

When multiple machines are connected to the RE32, each must be assigned a unique MACHINE NUMBER before the system is used for the first time. These must be assigned sequentially from 1 to the number of machines in the system and are used to allocate tracks to machines by the RE32.

Example 1: With two DR16pro machines:

Machine "1" = Tracks 1-16
Machine "2" = Tracks 17-32

Example 2: With three DD8 machines:

Machine "1" = Tracks 1-8
Machine "2" = Tracks 9-16
Machine "3" = Tracks 17-24

Please refer to the machine's own operators manual for detailed information. The following is intended to provide a brief description relevant to certain machines:

SETTING MACHINE ID NUMBERS - DR16pro

The DR16pro's MACHINE NUMBER assignment may be set as follows:

1. Press the SUB-MENU key followed by the 3 (SETUP) key on the numeric keypad then select AKAINET on the display by rotating the JOG/SHUTTLE control.
2. Press the STORE/ENT key. The message MACHINE 01 will appear in the display showing the current Machine ID.
3. Use the JOG wheel to select the required Machine ID number and press the STORE/ENT key to confirm the assignment and exit the menu.

SETTING MACHINE ID NUMBERS - DD8

The DD8's MACHINE NUMBER assignment is set on the AKNET INFO page which is accessed from REMOTE page in the SYSTEM menus. On the front panel of the DD8, press the SYSTEM key, followed by the MORE (F6) key then the REMOTE key (F2). Finally, press the AKNET key (F1) and you will see the following screen:

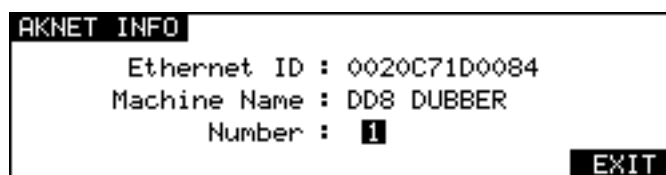

Note: DD8's front panel LCD

The NUMBER field shows the MACHINE NUMBER currently assigned. You may change the number using the DATA +/- keys and then save the new setting to flash ROM.

NOTE: Please refer to the operators manual provided with each machine for more detailed information about setting MACHINE NUMBERS.

POWERING UP THE RE32 SYSTEM

First, turn on any disk drives that may be connected to the system. Next, turn on the individual machines (DR16pro, DD8plus etc.). The machines will 'talk to' their disk drives and you will see some disk activity as they do this. When this has settled down, turn on the RE32. The external monitor screen can be switched on at any time and will have no effect on the system.

When you power up the RE32, the RE32 will scan the ethernet bus for connected machines. You will see this screen display momentarily:



A few seconds later, you will see this screen:



This indicates that the RE32 has successfully established communications with the connected machines. A few seconds after the RE32 is booted, you will see this screen which indicates that the system is ready for use:



If there is a problem with the AKAINET connections, the system will display this screen permanently:



This indicates that the RE32 has detected a fault and cannot communicate with the connected machines. If this occurs, check the AKAINET BNC cables to make sure they are securely connected. If that seems o.k., check the AKAINET termination switches. As shown in the diagram in the previous section, the TERMINATOR must be switched ON on the first and last devices in the chain and switched OFF on all other devices.

If this doesn't work, try powering everything down and trying again. If you still find that you cannot boot up, please contact your dealer.

But take heart! This should not happen and if you do have problems, you will probably find it is nothing more serious than a damaged AKAINET BNC cable or that the AKAINET termination has been incorrectly set. If these are alright, however, but the problem persists, you should contact your dealer.

PANEL LAYOUT

The RE32 is an MTR style remote controller with many commonly used functions available on dedicated keys. If you break down the RE32's panel into its various sections, it really is quite straightforward to understand and use.

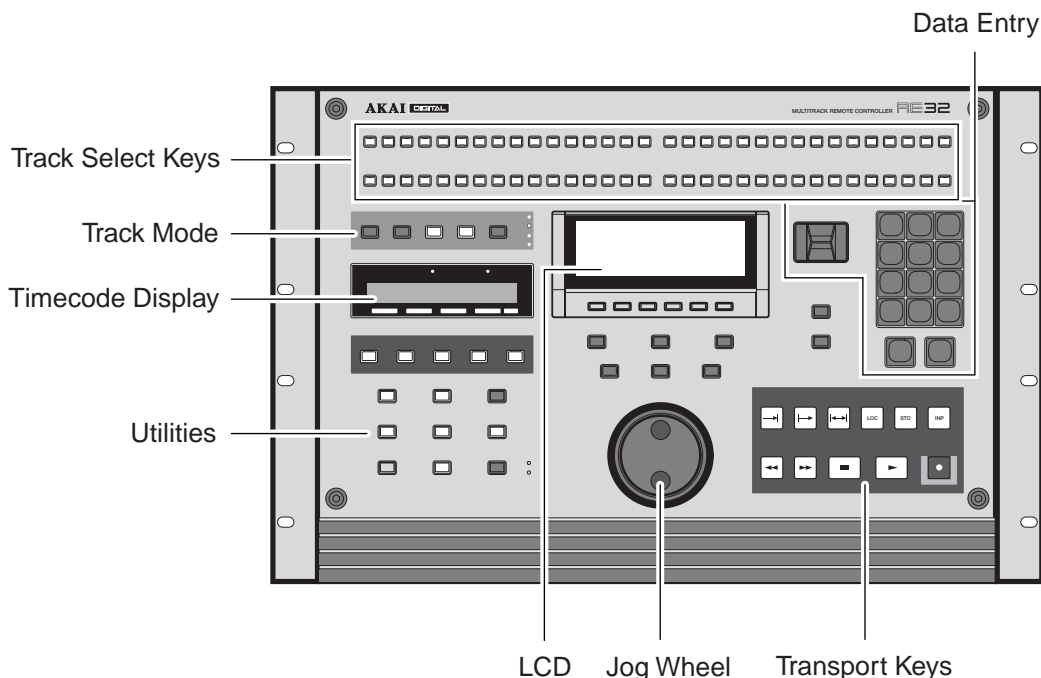

Across the top of the panel are the track select keys. The top row of keys are used to turn tracks on and off for playback. The second row of keys are used to either select tracks for recording or for editing. When these keys are showing edit tracks, they are illuminated in green whilst record track selections are shown illuminated in red.

The TRACK MODE keys are used to setup the function of the track select keys.

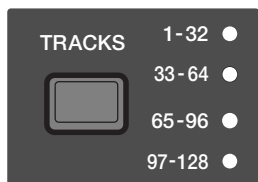

The TRACKS key is used to select which bank of tracks are currently assigned to the 32 track keys.

The RE32 can control up to 128 tracks in 4 banks. The currently selected bank is indicated by the column of LEDs next to the TRACKS key.

The GROUP keys allow you to store and recall combinations of track settings.

The LCD displays information concerning the status of the system at any time as well as being used to provide soft keys, the function of which changes according to the system's status.

The TIMECODE DISPLAY shows the current now time.

The UTILITIES keys give you access to functions such as DISK, SETUP, EDIT, PREROLL etc.. The amber SHIFT key gives access to keys' sub-functions and these are shown in amber text beneath the keys.

The TRANSPORT keys provide the basic PLAY, STOP, REWIND, FAST FORWARD, etc.. They also offer special 'edit play' keys used when editing and these include PLAY TO, PLAY FROM etc..

Located directly beneath the LCD is a row of six soft keys, the function of which depends on the RE32's current status.

The JOG wheel emulates reel rocking for finding edit points. It is possible to jog all tracks simultaneously.

The DATA ENTRY section includes a numeric keypad for inputting timecode and values and for selecting locator memories and edit clipboards. The +/- DATA ENTRY keys allows you to set parameter values whilst the CURSOR keys are used for selecting parameter fields in the RE32's LCD. The +/- DATA ENTRY keys can also be used to nudge audio into sync and to go to the next and previous cues and the CURSOR keys double as vertical and horizontal zoom keys. The SCROLL VIEW keys are used to scroll the vertical selection of tracks currently being shown on the VGA.

VGA DISPLAY

The RE32's VGA display is designed to present all the information you will need in a simple and easy to digest manner. There are no multiple windows stacked on top of each other to confuse you, and ALL work (including recording, editing, slipping, syncing, etc..) is done here ensuring that operations are consistent throughout.

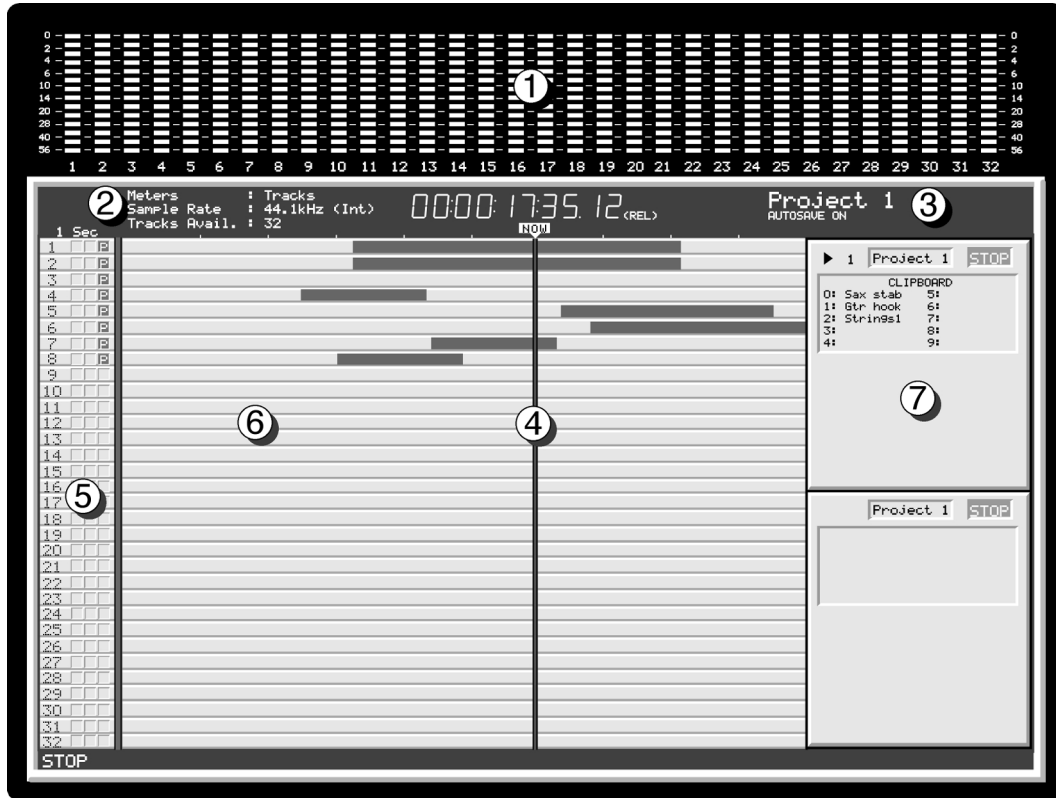

1 TRACK METERS

At the top of the screen is a meter bridge where you may see the levels of each individual track.

2 SYSTEM STATUS

Information relating to the current system settings is displayed at the left hand side of the status bar above the GRID. This includes the signal source for the meters, the project sample rate and the number of tracks available in the system.

3 PROJECT NAME

At the right hand side of the status bar above the GRID right is displayed the currently selected project's name

4 NOW TIME

Directly above the GRID is the NOW time and this indicates the current time on the NOW line that intersects the GRID vertically in the centre. The NOW line position may be adjusted so that you can see more or less of what is coming as the cues scroll.

5 TRACK STATUS

This shows the current status of the tracks - i.e. PLAY, REC, and EDIT.

6 GRID

The GRID (**GR**aphic **I**nterface **D**isplay) shows the audio as waveforms and/or as blocks and you may choose whether to display waveforms or not according to your preference. Consistent colour coding is used throughout - blue for play, grey for muted, red for record, green for edit and light brown (ochre) for EDIT CUE. This allows you to see at a glance the status of the tracks even from a distance. The waveforms/blocks scroll during playback and you may zoom in horizontally or vertically for more precise editing and the RE32's real-time operating system even allows you to zoom in or out when the machine is currently busy doing other things such as playing back, recording, etc.. It is also possible to show cue names and these are shown in a column on the right of the GRID.

7 CLIPBOARDS

When Single Machine Edit Mode is selected, these panels are shown on the right hand side of the screen. Each panel is aligned vertically with the tracks related to the corresponding machine.

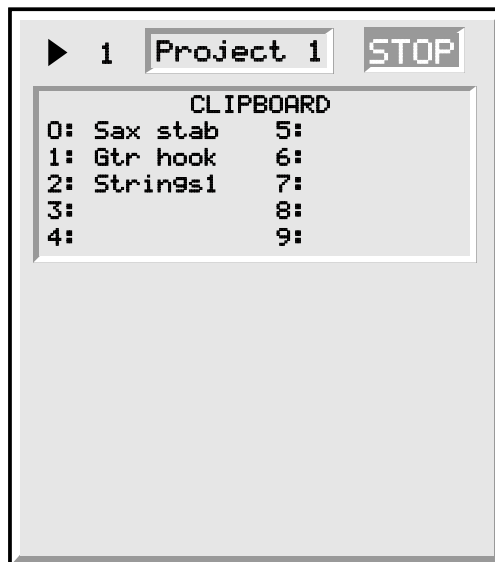

The top line of this box shows the machine number, the name of the project currently loaded on this machine and the current transport status (PLAY, STOP etc..)

The ► symbol is shown alongside the currently selected machine. The next box displays either the current project name or the machine name, depending on the setting in the INFORMATION field on the SHOW ON VGA MONITOR - MACHINES page. This box will be coloured red while the machine is in record and in a mustard colour while the machine is in rehearsing a record. The final box displays the machines transport status (STOP, PLAY etc..).

Below this are shown the edit clipboards available on this machine. These are the ten edits available for pasting and/or inserting into a project at any time. The EDIT CLIPBOARD will be explained fully later in the section "EDITING".

INTRODUCTION

CUE NAME DISPLAY

To the right of the track display, you may choose to see the names of the cue(s) currently being played. This is used instead of the normal convention on other hard disk recorders where the name is shown within the cue itself because with short cues, the name often gets abbreviated into something meaningless. This can also make the screen very cluttered. On the RE32, you see the entire name regardless of its length.

For example:



'Conventional' disk recorder cue name display.

Whilst the long music cue can display the full name, the footsteps SFX on the adjacent tracks (called FOOTSTP 1L and FOOTSTP 1R) are abbreviated to FO. Compare this with the RE32:

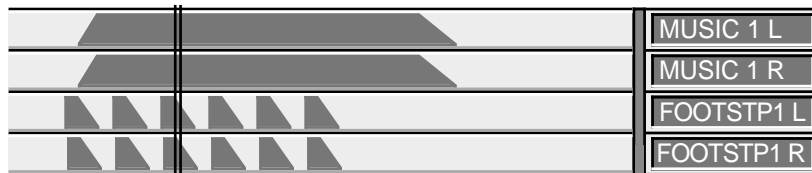

RE32 cue name display.

On the RE32, regardless of the length of the cue, the entire name is shown clearly.

NAVIGATING THE RE32

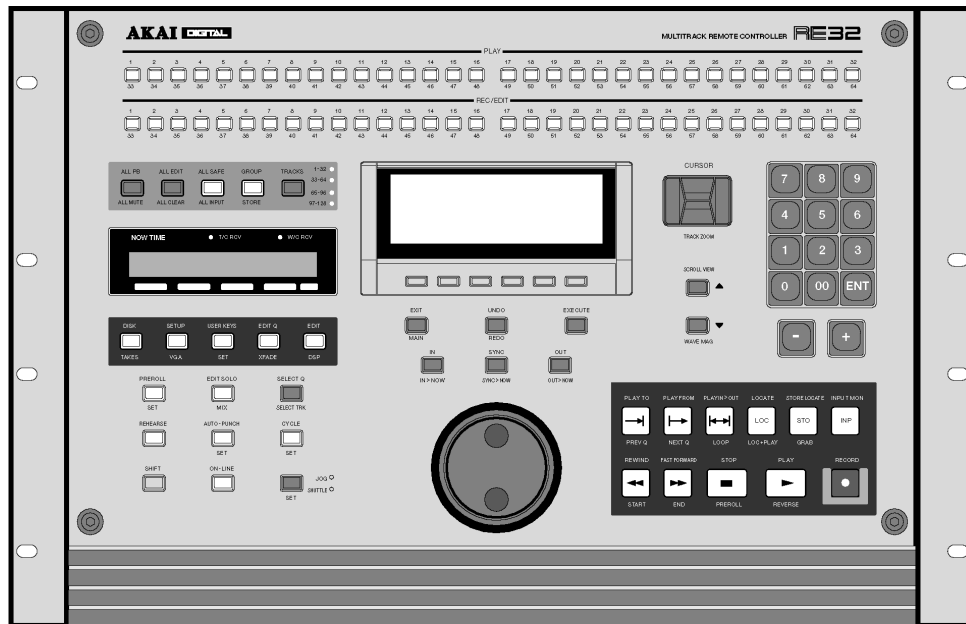

Getting around the RE32 is quite straightforward. Dedicated keys for most commonly used functions reduces the need for multi-menu operation. Less day-to-day functions are kept hidden away out of harms way but are still readily accessible.

The external monitor is used purely for referencing your work to see what is going on. You can think of it as an animated track sheet. In theory, the RE32 could be used without it as most work is done from the RE32's front panel LCD.

The keys we will look at in this section are highlighted in the above diagram although others may be referred to where necessary.

CURSOR KEYS

You use the four CURSOR keys to move around the LCD. In the following example, the page is displaying a list of files and the CURSOR keys are used to scroll up and down the list in order to select one.



You can also, in this example, move the cursor to the top line to select a different disk. Disk selection would be made using the DATA ENTRY +/- keys or by typing in a number directly from the numeric keypad.

NOTE: The two arrows shown in this example indicate that there are files 'above' and 'below' the screen which may be accessed by scrolling up or down. This is a convention used in all file-lists in the RE32 (for example, when loading PROJECTS etc.). If the arrows don't appear, there are no files 'off-screen'.

The cursor keys are 'accelerators' - that is, they move faster the longer you hold them so scrolling through long lists of files or parameters is very fast.

INTRODUCTION

Another example of a typical screen is this:

```
SYSTEM RATES
Sample Rate : 44.1kHz
TC Frame Rate : 25 fps
```

This shows a list of parameters. To change any of them, move the cursor to the one you wish to change and use the DATA ENTRY +/- keys to select a new value. In cases where there are many options to select, the DATA +/- keys are 'accelerators' that speed up the longer you press them.

However, it is not always necessary to use the cursor keys to move up and down parameter lists and some pages offer a more direct approach to parameter selection. For example:

```
INSERT FROM CLIPBOARD
INSERT length : 00:00:03:12.8
From clipboard : 0
Referenced to : SOURCE IN
Slip type : SLIP WHOLE TRACK
Slip?
```

In this example, INSERT, you can select the clipboard to insert from simply by pressing any of the numeric keypad's number keys 0-9. You can specifically move the cursor to the REFERENCED TO field if you wish to select IN, SYNC or OUT with the DATA ENTRY +/- keys but you can achieve this more easily by just pressing the IN, SYNC or OUT keys - the display will change accordingly, showing your selection. You can also see a '?' softkey. This conveniently 'toggles' selects the SLIP TYPE parameter.

TRACK ZOOM KEYS

The CURSOR keys are also used with the SHIFT key to zoom in and out on tracks.

SHIFT plus the CURSOR \leftarrow/\rightarrow allow horizontal zoom in/out. You may also use these keys simultaneously to switch between maximum horizontal zoom in and a zoom out of your choice by pressing SHIFT+CURSOR \leftarrow/\rightarrow keys simultaneously. To do this, zoom in to the level of your choice - pressing SHIFT and the CURSOR \leftarrow/\rightarrow keys together will now switch you between that level and maximum zoom.

SHIFT plus the CURSOR \uparrow/\downarrow keys allow you to zoom in vertically on tracks. SHIFT+ \downarrow will zoom in, showing fewer and fewer tracks whilst SHIFT+ \uparrow will zoom out, showing more tracks. As you zoom in, so you will see tracks 1-24, 1-16, 1-12, 1-8, 1-4, 1-2 and finally, 1 displayed on the external monitor.

SCROLL VIEW KEYS

When the display is zoomed in, you may want to view different tracks to the ones shown on the screen. This can be done using the SCROLL VIEW \uparrow/\downarrow keys to scroll up or down to the required tracks. For example, if the display is currently zoomed in to display tracks 1-4, pressing SCROLL VIEW \downarrow will scroll the display to show tracks 5-8.

In the SHOW ON VGA monitor page, you may set the RE32 so that tracks selected for edit are those that are shown on the VGA as you zoom in. For example, with tracks 3 and 4 selected for edit, when you zoom to two tracks, 3 and 4 would automatically be placed at the top of the screen. Please see the section that describes the SHOW functions for more details on this.

The SCROLL VIEW keys are also used with the SHIFT key to increase or decrease the waveform magnification on the external monitor.

NUMERIC KEYPAD

The NUMERIC KEYPAD has two main functions. It is used to store and recall up to 10 edits in what we call the EDIT CLIPBOARD (see the section on editing that describes this). It is also used for timecode and numeric entry.

EDITING NUMERIC FIELDS

To edit number fields, you can just type the number directly followed by ENT on the numeric keypad or the main EXECUTE key. You may also use the DATA ENTRY +/- keys to increment/decrement through the values.

If you make a mistake, press EXIT - this will restore the parameter's previous value.

EDITING NAMES THAT INCLUDE NUMBERS

In names that have a number as part of the name (i.e. PROJECT 5), this can be renamed very quickly simply by pressing any other number on the numeric keypad. For example, pressing 9 would immediately change this name to PROJECT 9. This can be useful when saving a project with a different name (SAVE AS). It is also useful for quickly renaming libraries or clips.

ENTERING TIMECODE VALUES

Timecode is entered using the NUMERIC KEYPAD. Values enter from the right and time divisions (i.e. hours, minutes, seconds and frames) are confirmed using the keypad's 00 'double zero' key.

For example, to enter a value of 1 hour, 23 minutes, 12 seconds, 12 frames, type the following:

1, 00, 23, 00, 12, 00, 12, 00, ENT

You will see the following display in the selected timecode field as you enter the numbers:

1	:	:	:	10
00	:	:	:	1:00.0
23	:	:	:	1:23.0
00	:	:	:	1:23:00.0
12	:	:	:	1:23:12.0
00	:	:	:	1:23:12:00.0
12	:	:	:	1:23:12:12.0
ENT	:	:	:	1:23:12:12.0

The important thing to remember is to 'confirm' the time division using the numeric keypad's 00 'double zero' key.

If you make a mistake when entering a timecode value, press EXIT. This will restore the field's previous timecode entry and you may try again.

It is also possible to 'nudge' timecode entries. You can move the cursor 'within' the timecode field by pressing SHIFT+DATA ENTRY +/- . As an example, in EDIT CUE, you may wish to nudge a fade up time from 2 seconds to 3 seconds. Rather than type in 3, 00, EXECUTE, move the cursor to the seconds field using SHIFT+DATA ENTRY +/- as appropriate and use the DATA ENTRY + key to increment by one. For example:

Fade up : 00:00:02:00.0

The digit is highlighted with an 'underbar'. Now press SHIFT + DATA ENTRY '-' to move the cursor left and press the DATA ENTRY + key:

Fade up : 00:00:03:00.0

In this way, instead of having to type out long strings of timecode numbers, you can nudge a timecode field to a value quite easily.

INTRODUCTION

DATA ENTRY/NUDGE KEYS

These two keys allow you to set data values.

To set a data value, simply move the cursor to appropriate field and press the DATA ENTRY '+' key to increase the value or the DATA ENTRY '-' key to decrease the value. Like the CURSOR keys, these keys are 'accelerators' that get gradually faster the longer you keep them held down, allowing rapid changes to be made to long parameter fields.

These keys are also used with the SHIFT key to move the sub-cursor left or right within a parameter field as described above for entering timecode values.

USING THE SOFT KEYS

The soft keys perform two main functions. One is to take you to another page, another is to perform some kind of action.

Page keys are highlighted - i.e.: **DISK** will take you to the disk page.

Action keys are 'hollow' - i.e.: **SAVE** will save the current file.

There is another type of action key that we saw a bit earlier and that is the '?' action key. These use Lower case characters and refer to the name of the parameter they are linked to. These allow you to switch parameters in the field they refer to.

There are also double width soft keys: **OFFSET** or **DEFAULT**

These may be page keys (highlighted) or 'action' keys (hollow) as described above. There can also be double width '?' action keys. When a double width key is used, either of the soft keys directly below it may be used.

In some pages, the soft keys act as 'radio' keys - i.e. switching one on will switch one or more others off - and select different functions. In this case, the selected key highlights. Although these look essentially like 'action' keys or 'page' keys, the distinction should be clear from the context of the page you are in.

EXECUTE

Nearly all actions on the RE32 require completion using the EXECUTE key located beneath the soft keys. This key has a LED in it that will flash indicating that it should be pressed to complete the action. You may also receive a prompt to tell you to press EXECUTE. Sometimes, where multiple prompts are shown (i.e. "DELETE SELECTED FILE?" followed by "ARE YOU SURE? NO UNDO!"), the EXECUTE key will remain flashing until the whole process has been completed. Basically, whenever the EXECUTE key is flashing, this indicates that you must press it to complete an action.

EXECUTE can also be used to complete entering a name or number or timecode value.

EXIT

Whenever the EXECUTE can be used (i.e. its LED is flashing), the EXIT key will abort or cancel the process without committing it. This is your 'escape route' should you be in a situation where you change your mind. The EXIT key also functions as a "NO" key in situations where YES/NO responses are required.

At all times, the EXIT key will take you out of the current page and back to a 'safe' situation.

In cases where you have arrived at a page by going through other pages first (for example, SETUP, DISP, OFFSET) the EXIT key will take you back step by step through those pages until you arrive back at the main display.

UNDO

The UNDO key offers twenty levels of undo and redo. If you make a mistake and do something you're not happy with, press UNDO and the original data will be restored. If you then find that you preferred the mistake, press REDO (SHIFT+UNDO).

You may undo/redo the last twenty things you did by repeatedly pressing UNDO or REDO (SHIFT+UNDO). This allows you to try a few edits out in succession and then, if you don't like the results, restore the original version.

NOTE 1: *The UNDO function only refers to recording and editing. You cannot undo anything else. For example, if you load a project and change your mind, you cannot undo that. If you select some tracks for edit when you really meant to select them for record, you cannot undo that.*

NOTE 2: *IT IS NOT POSSIBLE TO USE UNDO IF YOU DELETE A FILE (I.E. A PROJECT) BY MISTAKE. PLEASE TAKE CARE WHEN DELETING FILES.*

SHIFT

The amber SHIFT key gives access to sub-functions on certain keys. Most keys' sub-functions relate to the key itself (for example, many keys have sub-functions to SET parameters associated with the main function of the key).

When using certain sub-functions such as VGA (SHIFT+SETUP), XFADE (SHIFT+EDITQ), the keys' LEDs flash indicating you are the key's 'alternative' function.

SET FUNCTIONS

Some keys' SHIFT function is SET, allowing you to set up certain parameters relevant to the key (for example, SHIFT+PREROLL allows you to set the preroll time). When using SET pages, the LED will not flash but will be lit according to whether that key is switched ON or OFF (for example, when setting the PREROLL time, the LED will indicate whether the PREROLL function is turned on or off).

NOTE: *Not all keys' SET functions are operational. Some of the SET functions are reserved for future enhancements via software.*

JOG WHEEL

The jog wheel is normally used to 'scrub' audio when finding edit points. It is possible to jog all tracks simultaneously. You may also use the jog wheel to 'spool' through a project and the jog wheel acts as a speed control for forwards or backwards playback.

The function of the jog wheel is selected by pressing the JOG key to toggle the function. The current function is indicated by the JOG/SHUTTLE LEDs located next to the key. When both LEDs are lit, this selects a special 'JOG VIEW' mode which allows you to jog through the project but without audio.

NAMING FILES

Although the RE32 has an auto-naming function for naming recordings, projects, etc., sometimes it is necessary to name files yourself. Typically, you want to name projects, libraries and clips most of the time and you may wish to name edits prior to copying them into the clipboard.

Naming is usually done from a PS/2 ASCII keyboard connected to the RE32. The computer keyboard is connected to the KEYBOARD input on the rear of the RE32.

When the cursor is placed on a filename and a key is pressed on the PS/2 keyboard, the selected file will be highlighted thus ready for editing:

Project

The first character of the name will be highlighted and you may type in a name of up to ten characters.

INTRODUCTION

As the LCD prompts you, you must press EXECUTE to complete the naming process. If you change your mind, press EXIT at any time. Pressing EXIT will leave the naming process and revert to the original name.

When using a computer keyboard, you will note that the numeric keypad functions just like the RE32's. You will also note that you can use the keyboard's first six function keys to duplicate the RE32's soft keys. ESC(ape) duplicates the action of the RE32's EXIT key. SHIFT and CAPS LOCK work as you would expect as do the cursor keys which duplicate the action of the RE32's CURSOR keys. In fact, for the most part, you will find that the keyboard performs much like it would when used with a computer.

NOTE: The following characters are not available from the computer keyboard:

£ \$ ^ & { } [] @ | ~ ' + -

The following keys also have no function:

TAB CTRL ALT PAGE UP PAGE DOWN
HOME END F7-F12 PRINT SCREEN SCROLL LOCK

RENAMING FILES

There will be occasions where you want to rename an existing project, library or clip. Renaming is exactly the same as naming a file - move the cursor to the file you wish to rename and start typing to enter a suitable name.

You may also re-name existing files that have a number in them very quickly just by pressing any of the numeric keys. For example, you can rename PROJECT 1 to PROJECT 2 simply by pressing 2, EXECUTE.

You can also add numbers to files in this way. For example, to re-name the file ANIMALS to ANIMALS 1, simply move the cursor to the file, press 1, EXECUTE. Again, pressing EXIT will abort the naming process.

PROMPTS

Two types of prompts are used on the RE32. One is a temporary one that is displayed for information only. I.e.:



This pops up and lasts for a few seconds. Pressing any key while it is displayed will clear the message. Different messages stay up for different lengths of time depending on the nature of the message. If the message relates to something fairly serious such as DISK DRIVE NOT READY, the message will stay up longer than, say, the message FILE COPIED or PROJECT LOADED. In the event of a really serious problem, the message may stay up permanently until any key is pressed.

You may also receive this kind of prompt on the bottom line of the LCD:

Overwrite existing file?

In this situation, the EXECUTE key's LED will be flashing and you should press EXECUTE to continue (the equivalent of answering "YES" to the prompt) or EXIT to abandon what you are doing (the equivalent of responding "NO").

GETTING AROUND A PROJECT

There are many convenient ways to move around the GRID.

TRANSPORT KEYS

The most obvious way, perhaps, is to use the REWIND and FAST FORWARD keys. Pressing either << or >> once will cause the project to rewind or fast forward at 10 x normal play speed and pressing it again will cause the project to rewind or fast forward at 100 x normal play speed. Pressing either of these keys again will revert to 10 x normal play speed.

During playback, simultaneously pressing PLAY (▶) plus either the << or >> keys will allow you to rewind or fast forward with ‘tape chatter’ and you will hear the audio rewinding or fast forwarding at high speed much like a normal MTR.

NOTE: When rewinding or fast forwarding with ‘chatter’, you may notice that some tracks will be dropped. This is normal as the connected machines cannot play all tracks at high speed. However, if your project only has a few tracks to begin with, then this won’t be so noticeable.

LOCATE FUNCTION

Another way to get around a project would be to set locate points using the STORE LOCATE key and use the LOCATE key to locate directly to those points. 100 locate memories may be stored per project. You may also go to a timecode position directly by hitting LOCATE and typing in an appropriate timecode value.

You may also mark ‘grab markers’ using the GRAB function (SHIFT+STORE LOCATE). This will ‘drop’ un-numbered markers along the scroll bar and these can be used as you like. You can mark locate memories and grab markers ‘on the fly’ as you are playing back (or indeed, jogging, spooling, even rewinding). 100 ‘grab’ markers can be set per project.

You can also use LOCATE with the IN, SYNC and OUT keys to go to these points.

You may also go to the start and end of a project using F5 and F6 in the GOTO LOCATE TIME page when you press the LOCATE key.

NEXT/PREVIOUS CUE

By pressing PREV Q (SHIFT+PLAY TO) or NEXT Q (SHIFT+PLAY FROM), you can go to the start and end of each cue in turn on the track(s) selected for edit. I.e.:

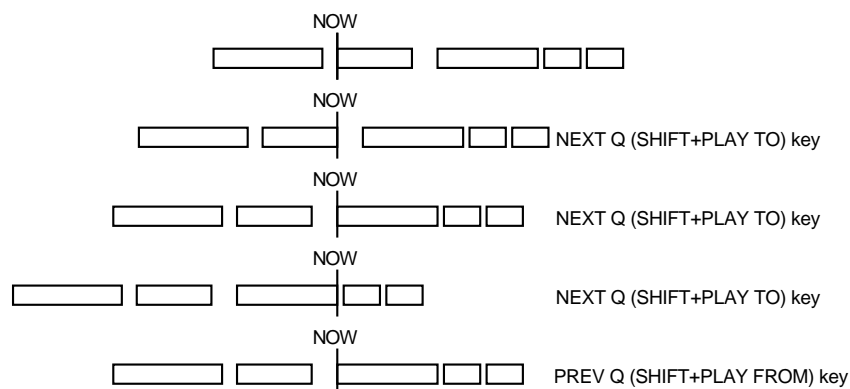

If a track is selected for edit, these keys take you to the start and end of each cue in turn on that track. If no tracks are selected for edit, they take you to the start and end of each cue on the tracks selected for playback (i.e. shown blue on the external monitor). If no tracks are selected for playback or editing, these keys have no function.

INTRODUCTION

JOG WHEEL

The jog wheel allows you to 'scrub' audio much like reel-rocking on a conventional tape recorder. You may jog all tracks simultaneously. Normally, maximum jog speed is 1 x play speed but you may set this to be as much as 5 x maximum play speed. More conveniently, perhaps, you can set it so that normal operation gives a maximum jog speed of 1 x play speed but, when the SHIFT key is held, you can jog up to 5 x play speed.

The jog wheel can also act as a 'spool' function and the jog wheel then sets the speed and direction of playback. Maximum spool speed can be set to 5 x play speed.

You may also use the jog wheel to 'scroll' through a project very quickly. In this case, all you are doing is 'sliding' the GRID on the VGA monitor, allowing you to get to points 'off screen' very quickly. In this case, no audio is heard.

JOG, SPOOL and SCROLL are selected using the JOG/SPOOL key. This selects whether the jog wheel described below 'scrubs' audio, spools audio or scrolls through the project. When the JOG LED is on, the jog wheel will scrub audio. The jog wheel is always active, even in play, so that you can just grab the jog wheel and start editing straight away.

When SPOOL is on, the jog wheel will spool audio.

When both LEDs are on, you can scroll through the project very quickly and no audio will be heard but this does allow you to get to points in the project very quickly.

When both LEDs are off, the jog wheel has no function. This position is recommended when mixing down so as to prevent accidental jogging during playback.

JOG/SPOOL SET

By pressing SHIFT+JOG/SPOOL, it is also possible to set maximum jog and spool speeds. You will see this screen display:

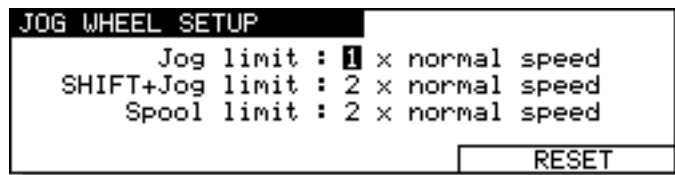

The fields are:

JOG LIMIT

This may be set to a maximum of 5 x play speed. If you only occasionally require jogging to be greater than play speed, it is recommended you keep this field set to 1 x play speed and use the SHIFT+JOG functions described next.

SHIFT+JOG LIMIT

This allows you to set the maximum jog speed when pressing SHIFT plus the jog wheel together. Maximum speed is 5 x normal play speed (although 2 x normal play speed is probably the most useful as the audio is still fairly intelligible).

SHIFT+JOG is very convenient when editing because you can use the jog wheel for normal jogging (JOG LIMIT set to 1 x PLAY SPEED - see above) to find edit points, etc., and use SHIFT+JOG when you need to whiz through audio to the next edit you wish to make.

SPOOL LIMIT

This allows you to set the maximum spool speed which is 5 x play speed.

NOTE: *When jogging or spooling at anything higher than nominal play speed, because of restrictions regarding disk speed and SCSI bandwidth, the connected machines will automatically drop some tracks to allow the high speed playback. However, in most cases this is fairly transparent and should not be particularly noticeable, especially on faster drives.*

The RESET soft key on F5/F6 will reset the selections you make to their default value.

Press SHIFT plus the JOG/SPOOL key again or EXIT to leave this page.

GETTING STARTED - BASIC CONCEPTS

Audio in the GRID is known as a CUE. A cue is a block of audio from start to finish. This may be a raw recording in its entirety or may be the result of an edit. For example:



This shows two cues. On the monitor screen, the cues' blocks are shown as blue and the waveforms (if selected to be displayed) are shown in grey.

NOTE: If the track is not selected for playback, the cue's block is shown in a light grey and the waveform in a slightly darker grey. I.e.



An EDIT REGION is the area that falls between the IN and the OUT times you have marked.



The IN and OUT markers are shown as vertical green lines. The edit region between the IN/OUT markers is highlighted green and the waveform (if selected to be displayed) is shown in black.

An edit area may exist across one or more cues (and across several tracks). For example:

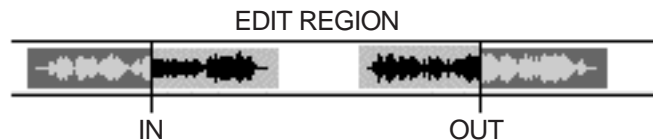

It is also possible to select a single cue for editing using the SELECT Q key. I.e.



Once selected in this way, the cue may be subjected to all the usual editing possibilities. SELECT Q allows you to select a cue for editing very quickly without having to specifically mark an IN and an OUT time. Once a cue is selected in this way, it can be subjected to all the normal editing procedures such as COPY, CUT and ERASE.

The basic operation is that you select a track (or tracks) for editing using the TRACK EDIT keys located along the top of the RE32's panel. Once you have found the piece of audio you wish to edit, mark an IN time using the IN key located above the jog wheel. Now jog or play to where you want the edit to end and mark an OUT time. Alternatively, line up the cue(s) you are interested in on the NOW time and press SELECT Q. Pressing the EDIT key will take you to the main edit page where you may use any of the editing functions such as copy, cut, paste, insert etc..

As a very simple example, imagine you wish chop out a cough from a vocal track on track 4. Select track 4 for editing, play (or locate or fast forward/rewind or jog) to the start of the cough, jog over it to find an exact start point (you may also refer to the waveform shown on the monitor for extra assistance) and press the IN key. Now jog to the end of the cough and press the OUT key at an appropriate point. Pressing the EDIT key and selecting CUT will get rid of the cough and close the gap, shifting all subsequent audio backwards accordingly; pressing the EDIT key and selecting ERASE will also get rid of the offending cough but will keep the gap created, thus preserving timing. For example:

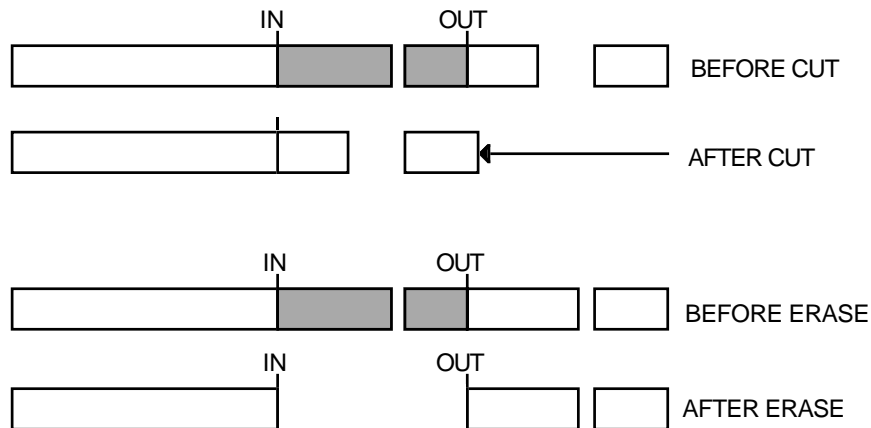

You may, of course, edit entire cues in this way. For example, let's say you have a backing vocal you wish to copy, select the track for editing, go to the cue, press SELECT Q followed by EDIT and COPY. In this case, you have not needed to specifically mark IN and OUT times - simply selecting the cue was sufficient. Multiple cues (across several tracks if necessary) may also be edited this way. You may now locate to the point you want to place the copy and press PASTE or INSERT.

Of course, this is just a very simple example and there are many different ways the RE32 system may be used to edit and sync audio. However, whatever it is you are trying to achieve, you will find that all functions are consistent, making operation easy and fast.

BASIC SYSTEM SETTINGS

Before we move on to look at basic operation, it is necessary to have a look at the SETUP pages in order to set the system up as necessary. If you just want to get on with some recording, skip this section and come back to it at a later date if you wish.

The SETUP pages allow you to set certain parameters that will affect either the RE32, an individual machine or the system as a whole. These include setting sample rates, timecode types and inputs, external connections, etc. Once configured, your system settings can be saved so that you may personalise your operating system.

Pressing the SETUP key displays this screen:



The soft keys F1-F5 take you to the various setup menus. As there are more menus than soft keys, F6 is used as a "MORE" key to scroll through the list of menus in groups of five:



Many SETUP pages include a parameter in the top right hand corner labelled MACHINE. This allows you to select if parameter settings are applied to the system as a whole (MULTI) or to a single machine (referred to as ID1, ID 2 etc..).

The MULTI SETUP pages are designed to allow easy configuration of parameters that should be set identically on each machine connected to the system.

Pressing RATES (F1) will take you to the SYSTEM RATES page:

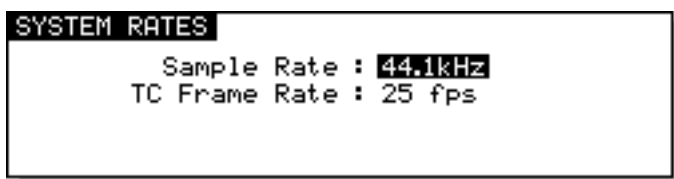

This page is used to set the system's global sample rate and frame rate.

The parameters are:

SAMPLE RATE This sets the system's sample rate. You may select 32kHz, 44.056kHz, 44.1kHz and 48kHz. Other options may be available depending on the facilities available on the connected machines.

On entry to this page, if all connected machines are set to the same sample rate, then this rate will be displayed. If not, the sample rate field will say "** DO NOT MATCH **" until a new rate is selected.

NOTE 1: This page will only allow selection of sample rates that are supported on all the connected machines.

NOTE 2: Recordings made at a sample rate other than the selected sample rate will play back at the wrong speed. For example, if the sample rate is set to 44.1kHz and you try to play back a recording made at 48kHz, the recording will play back slow. Therefore, please make sure that your recordings are made at the correct sampling rate. Recordings made at different sample rates cannot be used in the same project.

TC FRAME RATE

This shows the system's timecode rate.

This field is not editable, but instead serves as a visual check that all machines are configured correctly. If all machines are set to the same frame rate, then this rate will be displayed here. If not, this field will say “* DO NOT MATCH *”.

Timecode frame rates can be individually set on each machine as explained later in the section on TIMECODE SETUP.

The SETUP page's soft keys take you to other pages where certain parameters that affect the whole unit may be set. Not all of these are relevant for basic operation so, for the moment, we will continue looking at other modes that are necessary for basic operation.

FORMATTING DISKS

The DISK pages are used for general disk management such as renaming and deleting files, formatting disks, copying disks, etc.. For the moment, we will just look at formatting a disk as this needs to be done before you can start working with the Akai system. Pressing DISK displays this screen:



Assuming you have not used the system yet, no files exist on disk and so the DISK page is empty. If this is your first time to use the system, you may receive the message:



This indicates that the disk needs formatting. Press F5/F6-DISK UTILS You will see this screen:



Press FORMAT (F6) to see this screen:



The FORMAT TYPE field is used to select the type of directory that will be created on the disk when it is formatted. The options now available are:

DD-PLUS This is the current Akai DD-series disk format which allows 4000 files to be saved to a single disk and will give the best performance for real-time recording and playback of audio.

MACINTOSH This allows the disk to be formatted in Macintosh HFS format. Note that this option will create a single volume, erasing all existing partitions on the disk. If you want to create multiple partitions, it will be necessary to use a third-party Macintosh disk formatting application.

When the MACINTOSH format option is used, the disk may later be read on any Macintosh subject to the following limitations in various versions of the Mac OS:

- System 7.1 can only support volumes up to a maximum size of 2 gigabytes
- System 7.5 can recognise volumes up to a maximum size of 4 gigabytes (which is currently the maximum size supported by Protools and many other products)
- System 7.5.3 and above can recognise volumes up to a maximum size of 2 Terrabytes

NOTE 1: While the Akai machines can properly format a Macintosh hard disk or MO, it does not install any type of Macintosh driver software on the disk. Therefore, disks formatted on the Akai system will require third-party mounting software in order to appear on the Macintosh desktop.

COMPATIBILITY NOTE: Disks made on any version of DD8, DD1500, or DR8/DR16 can be used with current software versions. However, please be aware that DD-PLUS formatted disks cannot be used on previous versions or on other products that do not support this format.

You may select whether to just format the disk or format the disk and certify it afterwards. Formatting is very fast but if you select FORMAT & CERTIFY, this may take a while depending on the size of the disk. However, if this is the first time the disk is being formatted, it is recommended you run the certify process as well. This will mark out any bad blocks on the disk and prevent them from being used which will make the disk more reliable and not prone to read errors.

It is also possible to give the disk a name in the LABEL field. Here, you may enter a name of up to ten characters. This name will accompany the disk wherever you take it. To label the disk, move the cursor to the LABEL field and enter a name of up to ten characters using a PS/2 keyboard connected to the RE32. Press RETURN (or EXECUTE) once to complete the name and a second time to enter it.

NOTE: Naming a disk is not compulsory! This is here entirely for your convenience.

Once you have set everything as you want, pressing FORMAT DISK will show this prompt.

Erase everything? SHIFT+EXEC to confirm

To guard against accidental formatting, you must press SHIFT+EXECUTE simultaneously to initiate the formatting. As you can see from the screens and the prompts, formatting will erase everything, erasing all files on it completely. BE VERY CAREFUL BEFORE PROCEEDING.

If you have external disk drives connected to the system, you may select which disk you wish to format in the DISK field. PLEASE CHECK THE CORRECT DISK IS SELECTED.

The EXECUTE key will be flashing and you should select as appropriate. Pressing SHIFT+EXECUTE will start the format process and pressing EXIT at this point allows you to cancel.

NOTE: Pressing SHIFT+EXECUTE now will start the format process and will wipe the disk. Be very careful before proceeding as you could permanently erase important data. Once the format process has begun, there is no going back!!!!

If you press SHIFT+EXECUTE, you will receive this screen:

```
FORMAT DISK          Tracks: 1-16   Disk:0
                    Total  Cerified  Bad
Data blocks          0          0          0
Audio blocks         0          0          0
Formatting, EXIT to abort
```

If the disk is write protected, you will receive the prompt:

```
FORMAT DISK          Tracks: 1-16   Disk:0
                    Total  Cerified  Bad
Data b   Disk Write Protected  0
Audio b   0                    0
```

After a few seconds, the prompt will disappear and you will be returned to the main FORMAT DISK page. You should eject the disk and take the write protect off. However, there may be a reason the disk is write protected so it may be wise to leave the format page and check the contents before proceeding as there may be important data on it that needs to be kept.

NOTES ON FORMATTING DISKS

The full format and certify procedure takes between 20 minutes and an hour, depending on the size of the disk. During this time, the system writes a new, empty directory to the disk after which, if FORMAT & CERTIFY is selected as the format operation, it goes through the disk searching for bad blocks and marking them so that they won't be used.

We recommend that you do a full format to prevent the possibility of disk errors later on. However, if you wish, you can either select FORMAT ONLY as the format operation or you can just let the format run for 30 seconds or so (enough time to write the directory) and press EXIT to abort. In most cases, FORMAT ONLY should be sufficient but please note that AKAI professional cannot accept responsibility for disks that have not been fully formatted that show errors later on. It is recommended that you do a full format for brand new disks. If there are no bad blocks shown, there should be no need to do a full format again should you wish to re-format the disk for re-use at a later date.

As a final reminder...

FORMATTING THE DISK WILL ERASE THE CONTENTS COMPLETELY AND YOU WILL NOT BE ABLE TO RETRIEVE THEM.

We will come back to the other disk functions later as these are all to do with disk management (rename, delete, copy disks, etc.) and assumes there is audio on the disk. If this is the first time you have used the system, we need to get something onto disk before we can look at these functions.

DD-PLUS DISK FORMAT

The DD-PLUS disk format was introduced to replace the previous NORMAL and EXTENDED formats. Current software no longer directly supports writing to NORMAL or EXTENDED format disks created on earlier versions of software. Although both these disk formats are still recognised and fully supported for playback compatibility, any attempt to write to these disks will give an error message saying "Disk Format Is Read-Only!". EXTENDED format disks can be easily updated to DD-PLUS format and is described later.

These are the basic settings one needs to make for operating the RE32 system. We will look at other DISK functions later on.

VGA SETUP

The SETUP key's SHIFT function is VGA which allows you to setup various options related to the external display. When you press SHIFT+SETUP, the key's LED will flash and you will receive the following screen display:

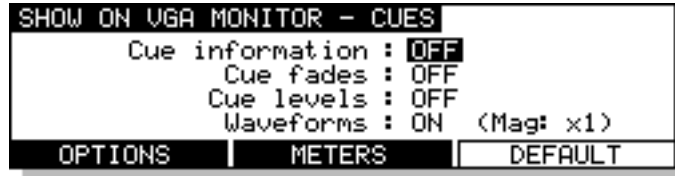

The options are split across several pages. The first page shown above offers the following:

- | | |
|-----------------|---|
| CUE INFORMATION | Allows you to select: |
| CUE NAMES | This will show the names of the current and, depending on the direction of playback/jogging/etc., the next or previous cues will be listed for each track down the right of the GRID. |
| DISK IDS | This will show the SCSI ID numbers of the disk drives the cues are playing from will be shown down the right of the GRID |
| DISK LABELS | This will show the disk label given in the FORMAT page down the right of the GRID. |
| DISK NAMES | This will show the name given to the disk in the FORMAT page down the right of the GRID. |
| CUE FADES | These can be switched ON or OFF. Scrolling is slightly smoother with the fades switched off. |
| CUE LEVELS | It is possible to show the cue's level with this option. The height of the blue box surrounding the waveform will vary according to its level (although this does have the effect of making the waveform display look off centre). CUE LEVEL may be switched ON or OFF. |
| WAVEFORMS | You may select whether the cues' envelopes are shown on the GRID and the options are ON or OFF. You will note that scrolling is slightly smoother with the waveforms switched OFF. |
| MAG | You may set the vertical magnification of the waveform envelopes. You may also do the same thing at any time more conveniently by using SHIFT+SCROLLVIEW. |

GETTING STARTED

Pressing the METERS key (F3/F4) will take you to the following page where you may set certain parameters relating to signal metering on the RE32's external monitor screen:

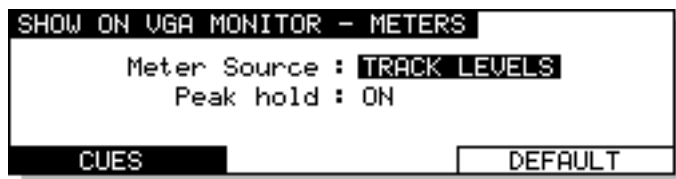

The parameters are:

METER SOURCE Here you may select what will be displayed on the meters on the VGA monitor. You may select INPUT LEVELS (to view the inputs to the tracks selected for record) or TRACK LEVELS (to show the level of the tracks playback or record signals depending on the current auto-monitor status).

NOTE: Tracks *must* be selected for record before their signal INPUT LEVELS will be shown in the meters.

PEAK HOLD Here you can set the response of the VGA monitor's meters when reading peak levels. HOLD will keep the peak level permanently displayed until a higher peak level is received. You may also turn peak level detection OFF if you wish.

Pressing CUES (F1/F2) will return you to the SHOW ON VGA MONITOR - CUES screen previously described. Selecting OPTIONS (F1/2) on the SHOW ON VGA MONITOR - CUES screen will take you to the next page shown below:

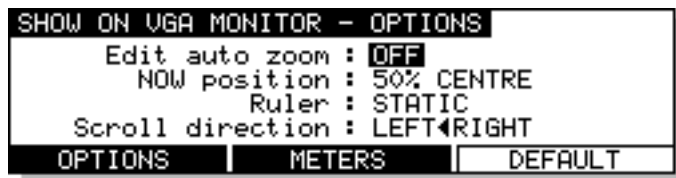

The parameters are:

EDIT AUTO ZOOM This function has three settings: OFF/MANUAL/AUTO.

With the parameter switched OFF, the vertical zoom in/out will zoom in from 32 tracks through 24,16,12, 8, 4, 2 and finally 1 track shown on the VGA monitor.

When switched to MANUAL, as you zoom in/out, if certain tracks are selected for editing, the monitor will automatically show the selected tracks as you zoom in. For example, if tracks 1, 2, 4 and 12 are selected, zooming in to eight tracks will show tracks, 1, 2, 3, 4, 5, 6, 7, 12; when you zoom in to four tracks, tracks 1, 2, 4 and 12 will be shown and zooming in to 2 tracks will, of course, show tracks 1 and 2. In many cases when editing, you want to zoom in on the tracks you are editing.

With this function switched to AUTO, as soon as you select a track for editing, the GRID will automatically zoom in to it. Any further tracks you select for edit will be shown on the monitor. For example, if you select track 3 for editing, the monitor will zoom in to one track, track 3. If you then select track 4, two tracks will be shown on the monitor, tracks 3 and 4. If you then select track 8, that too will be shown.

NOTE: When tracks are selected for edit, SHIFT+CURSOR UP/DOWN will toggle you between zooming in to the tracks selected for edit and the last selected vertical zoom level.

- NOW POSITION** You may set the vertical NOW marker anywhere on the GRID. 50% is central, lower percentages move it further to the left, higher percentages to the right.
- RULER** You can select whether the ruler across the top of the GRID will be static or will scroll with the project.
- SCROLL DIRECTION** You may set the direction in which the project scrolls. You may select LEFT ◀ RIGHT or LEFT ▶ RIGHT - the arrow indicates the direction.

Pressing the MACHINES key (F1/F2) will take you to the final page shown below:



The parameters are:

- MACHINE BOX** Switching this ON will force the machine box containing the CLIPBOARD DISPLAY and other information about the connected machines to be permanently displayed on the right hand side of the GRID. When this parameter is switched OFF, this box is only shown when single machine edit mode is selected as described later in the section on editing.

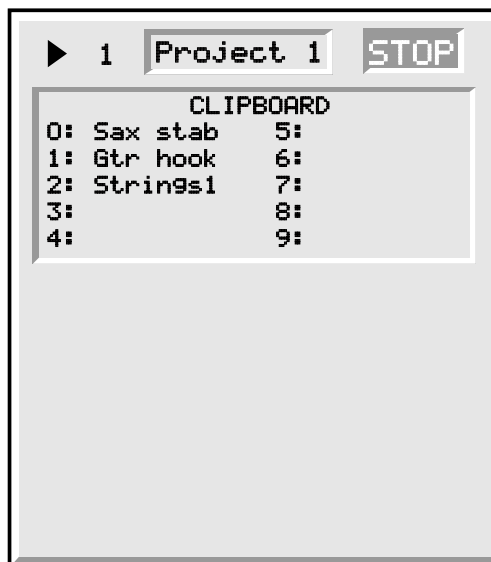

The top line of this box shows the machine number, the name of the project currently loaded on this machine and the current transport status (PLAY, STOP etc..)

The ▶ symbol is shown alongside the currently selected machine.

GETTING STARTED

INFORMATION This parameter selects whether the PROJECT NAME or MACHINE name is shown in the area at the top of the machine box.

ERROR MESSAGES Here you can select to display system error messages in a large pop-up window on the VGA. In multi-machine systems, as well as showing the system error message, this window will indicate the machine number on which the error occurred.

In all SHOW pages, you may reset the parameters to their default settings using the DEFAULTS soft key on F5/F6.

Press either EXIT or SHIFT+SETUP again to close this pages.

RECORDING

In the next few sections, we will see how to record and playback material as well as mark locators and locate to specific points in a project.

BASIC RECORDING

Before we can do anything interesting with the RE32, we must first make a recording. Because the RE32 has many standard multi-track tape recorder (MTR) keys, recording is very simple. There are no special, separate record modes to encounter; simply select a track (or tracks) for record and press PLAY and RECORD as you would on a normal MTR. There are other aspects to recording but we will look at those a bit later on.

To select tracks for recording, first switch off the ALL SAFE key if it is illuminated. This acts as a master 'record safe' and prevents accidental recordings being made while it is enabled. Once the ALL SAFE key is switched off, you may use any of the lower REC/EDIT keys to select a track (or tracks) for recording onto. When the track keys are selected, they will flash red indicating 'record ready'. The monitor will show RECORD in red in the track status display area and record indicators are also shown under each associated meter.

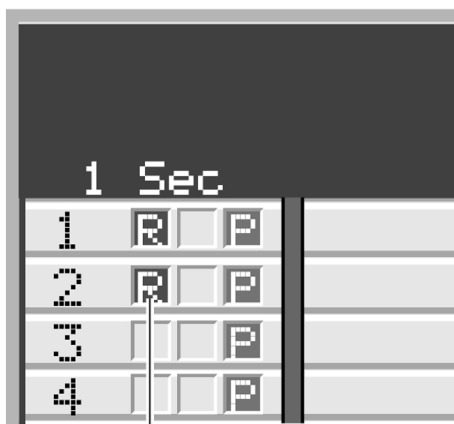

"R" is displayed when tracks are selected for recording

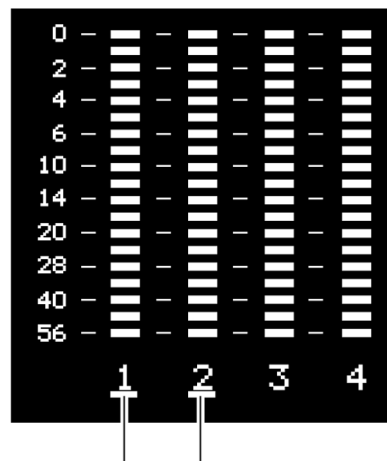

Red bars are displayed when tracks are selected for recording

Once you have made your selection, to record, simply press PLAY (to start playback) and then press PLAY and the red RECORD key together. The track key(s) will be steadily lit as will the transport RECORD key. On the monitor, the recording will be shown as a red block as it is recording.

To stop recording, press STOP. After a second, the recording you have just made will be shown in blue (assuming the track is selected for playback otherwise it will be shown grey) and the IN and OUT times will automatically be marked at the start and end of the new recording. The RECORD track select keys will flash indicating that you are back in 'record ready' state, ready to record again.

To drop out of record (i.e. stop recording but keep playing), simply press PLAY - the connected machines will drop out of record and keep playing.

NOTE: *There is a minimum time before you can punch in to record again after punching out using the STOP key. This is due to disk speed and will depend on the drive(s) you are using on each machine. If you are using hard disks, you will find that you can punch back in to record faster than if you are using slower drives such as MO (Magneto Optical) drives.*

It is also possible to start recording from stop by pressing the red REC key first and *then* pressing PLAY. You can stop recording by pressing PLAY again or by pressing STOP.

RECORDING

When recording, you will see this screen:

```
RECORD          Project 1          25fps
Recording name : VOCAL 1
Record mode  : PROJECT ONLY
Record Time  : 01:47:15:17.61
Recording . . . (SHIFT+REC to abort)
```

As you are recording, so the RECORD TIME field 'counts down' as disk space is used up. In the event of a mishap, you can abort the recording by pressing SHIFT and the red REC key simultaneously. This will stop the recording process and delete it from disk, thereby saving disk space and preventing the build up of unwanted recordings.

That really is all there is to do for simple recording - switch off ALL SAFE, select a track or tracks as appropriate, press PLAY and RECORD together, press STOP or PLAY to stop recording.

UNDOING A RECORDING

If you don't like the recording you just made, the simplest way to repair it is probably to record over it just like tape. It will be recorded over in the GRID but, because all recording and editing is usually non-destructive, you can setup the connected machines so that the actual audio will still be on disk so you can retrieve it at a later date if necessary.

NOTE: When you make a recording, the IN and OUT times are automatically marked at the start and end of the new recording. Because the AUTO-PUNCH function uses these times to punch in and out of recording automatically, if you wish to re-record over a recording you have just made, to ensure punch-in and out are at exactly the same position, switch on the AUTO-PUNCH function (see below - AUTO PUNCH IN/OUT).

Another way out of a recording disaster is to undo the last recording you made using the UNDO key. In fact, you could undo several of the recordings you have just made using the multi-level UNDO function. The number of 'levels' of UNDO available depends on the connected machine(s):

Machine	Number of UNDO levels
DD8 (16-bit)	4
DD8 (24-bit)	20
DR16pro	4
DD1500	20

Of course, should you change your mind, you can REDO the recording using SHIFT+UNDO (REDO). Not only can you use UNDO to repair mistakes you may have made but you could also use it to compare recordings. For example, you might make a recording that you think is acceptable but it could be improved upon so you re-record over it. After the second recording, you can use the UNDO function to compare the two. Being a multi-level undo, you could do this several times, making several recordings and then comparing them using UNDO and REDO, keeping the one you like best.

ADVANCED RECORDING

There is no 'advanced recording' mode as such - this section just tells you more about the recording functions.

Recording is designed to be as simple as possible and you may, if you wish, make a recording as described above. However, it is also possible to name recordings although recordings are given a default name so that you may avoid this process if you just want to get on with the job and the recording can be renamed afterwards. There are other parameters associated with recording which can set if you wish.

When you switch off the ALL SAFE key, you will see this screen:



The fields on this screen are:

RECORDING NAME Here, you may name the recording you are about to make by typing a suitable name of up to ten characters on a PS/2 keyboard connected to the RE32. Press RETURN to complete the naming process.

NOTE: The Akai DD/DR-Series of disk recorders have an 'auto-increment' function for names and so each new recording you make will have a new name based on the 'seed' name you give it here. For example, if you name a recording GUITAR, all subsequent recordings you make will be automatically named GUITAR 1, GUITAR 2, etc., until you specify a new 'seed' name in this field

The autoname function does not work when performing a punch-out followed by a punch-in. In this case, both recordings will have the same name. This is not a problem because recordings can have the same name in a project. Recordings can be renamed afterwards if you wish.

RECORD MODE In this field, you may select how the recordings you are about to make are stored in the project.

The default setting is PROJECT ONLY. With this selection, new recordings will be placed only into the currently active project. This selection is non-destructive - each time a new recording is made, existing files on disk from previous recordings will be unaffected.

You may also select DESTRUCTIVE. This is a special type of record mode that behaves more like traditional tape.

As mentioned, recording is non-destructive by default but, sometimes when recording, it is possible to build up a lot of redundant audio on your disk, especially if you are dropping in and out over the same point time and time again (for example, when recording vocals). As a result, your disk can soon become full of audio you cannot access or use. The DESTRUCTIVE record mode goes some way to overcome this.

RECORDING

When DESTRUCTIVE recording mode is on, if you record over existing cues, the audio associated with the original cue may be erased from disk. However, you must either record over the original cue completely, or start recording from within a cue to past its end - dropping in and/or out half way through the cue will not cause the original cue's audio to be deleted from disk. For example:

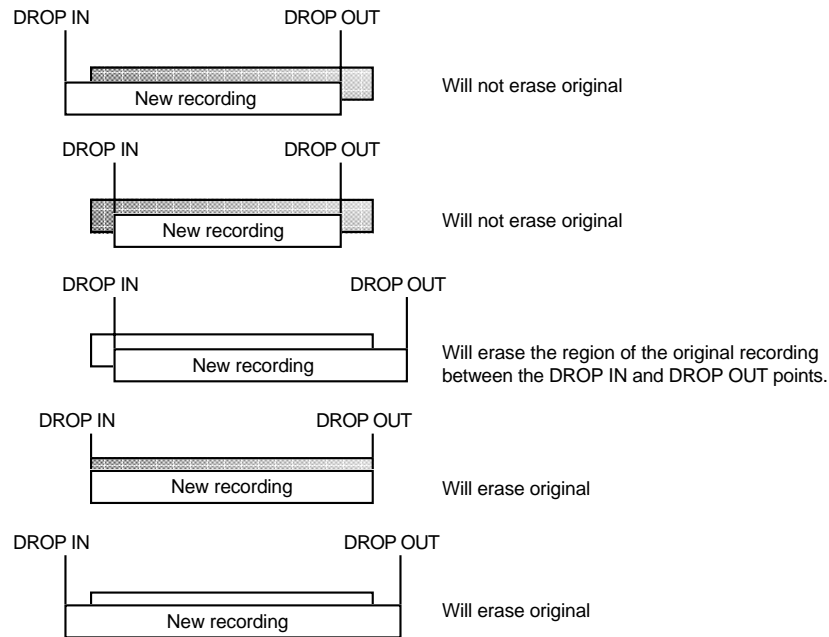

If you are using AUTO-PUNCH to drop in and out of record automatically and you have to keep repeating the auto-punch over and over again, the DESTRUCTIVE mode will be useful as it will help prevent the build up of unwanted recordings on your disk.

NOTE: There are certain considerations regarding destructive recording that you should be aware of.

- *THERE IS NO UNDO FOR RECORDINGS WHEN DESTRUCTIVE MODE IS USED.*
- *After you have just loaded a new project, as a safety factor, recording over cues in that project will not delete their audio from disk and the original project cannot be damaged. If, however, you record over cues recorded since the project was loaded, newly recorded cues' audio will be deleted from disk.*

The destructive record mode will go some way to avoiding the build up of unnecessary audio on your disk especially when performing multiple punch-in/out but, given the above points, there may be times when you will need to perform a manual cleanup or minimise.

**** WARNING ****

BECAUSE OF THE DESTRUCTIVE NATURE OF THIS FUNCTION, PLEASE MAKE SURE IT IS NOT INADVERTENTLY SELECTED WHEN RECORDING AS YOU RUN THE RISK OF LOSING VALUABLE DATA.

For example, if you are used to using non-destructive recording but receive a disk where DESTRUCTIVE record mode is enabled, you may be working in your usual way, thinking that new recordings are recoverable when, in fact, they are being deleted from disk every time you record over them. A good example may be where you are repeatedly dropping in over dialogue recordings, unaware that DESTRUCTIVE mode is set. You may think that you can retrieve 'out-takes' after the artist has left only to find that only the very latest recordings you made are available on disk. In this case, before recording over existing cues, please check that DESTRUCTIVE record mode has not been selected.

**** THERE IS NO UNDO WHEN DESTRUCTIVE RECORD IS USED ****

RECORD DISKS

By default, all audio will be recorded onto the same disk as the current project. In a larger system, you may have other drives to extend the recording time. However, please note that recording to an external drive could cause playback problems later on.

For example, in the case where you are playing back a project from an MO disk in Drive SCSI ID 0 but, for some reason, you record to a hard disk on SCSI ID 1, if the MO is removed and played back on another system, because some audio has been recorded on the other system's hard disk, that audio will not play. The cue will be shown bright yellow in this case indicating that although the cue is in the project, the audio is not on the selected disk. If you do record to an external disk, ensure that this disk accompanies the project disk.

Pressing DISK (F1) in the main record page take you to the RECORD DISKS page where you can select the drive each machine will use for recording onto:



The fields on this screen are:

TRACKS This is where you select the machine for which you want to select a record disk. To avoid confusion, the machines are listed by the tracks they represent. For example, machine 1 may be shown as "1-16", machine 2 as "17-32" etc..

RECORD DISK Here you may select which disk to record onto (assuming you have more than one drive attached to the system).

FREE ON DISK In this field, you can see how much time you have free on the currently selected disk. This field is not accessible and is shown for information.

You will note that as you select more tracks for recording, so the amount shown in the FREE ON DISK field changes. For example, if you have 12 minutes free on disk, when you select one track for record, that time remains unchanged. If, however, you select two tracks for record, that figure will halve, informing you have 6 minutes. Should you select another track, it will show that only 4 minutes is available.

Of course, you still have 12 minutes available in total but this available time is divided by the number of tracks you have selected. For example, in this case, when two tracks are selected, you still have 12 minutes free on disk but, because you are making two recordings you may only record for a total of six minutes.

RECORD TYPE

The type of file that is created on the disk for each new recording may vary depending on the format of the selected record disk and the user's choice of bit resolution. Pressing TYPE (F2) in the main record page take you to the RECORD TYPE page shown below:

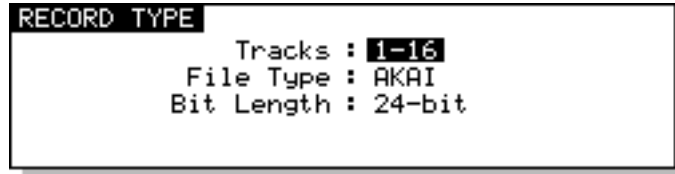

The options on this screen are:

- TRACKS** This is where you select the machine for which you want to select a record file type. To avoid confusion, the machines are listed by the tracks they represent. For example, machine 1 may be shown as "1-16", machine 2 as "17-32" etc..
- FILE TYPE** This selects the type of audio file that will be created when new recordings are made. The options available in this field depend on the format of the selected Record Disk.
- **AKAI:** This is the DD's native audio file format and is only available when the selected Record Disk is an AKAI format
 - **AIFF:** This is Apple's "Audio Interchange File Format" that is used by many Macintosh software applications. The AIFF option is only available when the selected Record Disk is Macintosh format.
 - **SD-II:** This is the native audio file format used by Digidesign Pro Tools and some other Macintosh software applications. The SD-II option is only available when the selected Record Disk is Macintosh format
 - **AKAI->FAIRLIGHT:** This allows special Akai audio files to be created which are intended for playback on a Fairlight MFX3plus system fitted with Akai File Exchange support. This option is only available when the selected Record Disk is an AKAI format

NOTE: Some of these file type options may not be available depending on the facilities available on the selected machine. Please refer to the section on **DISK COMPATIBILITY** for further information about recording to non-AKAI disks.

RECORDING

BIT LENGTH

This selects the audio bit length for new recordings.

- 16-bit: This is the compact Disc standard.
- 20-bit: This option allows 20-bit audio to be recorded, giving greater resolution and headroom.
- 24-bit: This option allows 24-bit audio to be recorded, giving even greater resolution and headroom.
- 20-bit (packed): This is a special option that is only available when recording AKAI format audio files. Typically, 20-bit audio occupies the same space on disk as 24-bit audio (the extra 4-bits of storage space in each sample being wasted). The 20-bit 'packed' mode avoids this waste of space by writing the audio to disk in a special pattern.

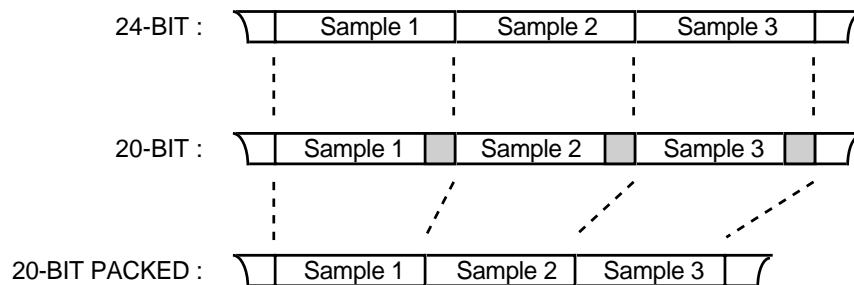

Note that this mode does *not* involve any 'audio compression'. It just places the data on disk in an optimal manner to maximise disk storage space and bandwidth.

RECORD SETUP

It is possible to select certain other options relating to recording in the RECORD SETUP page. This is accessed by pressing SETUP (F3/F4) from the main record page:

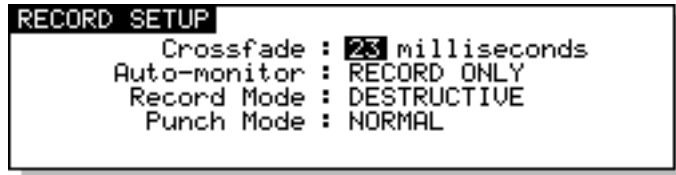

The parameters are:

CROSSFADE This allows a record crossfade of 0 to 80ms to be set.

AUTO MONITOR Here you may select how you will monitor the input signal. The default selection is RECORD AND STOP. With this selected, you will hear the input signal under the following conditions:

	STOP	RECORD	PLAYBACK
HEAR INPUT?	YES	YES	NO

RECORD TRACK'S PLAY SELECT KEY ON

	STOP	RECORD	PLAYBACK
HEAR INPUT?	YES	YES	YES

RECORD TRACK'S PLAY SELECT KEY OFF

The other selection you may make is RECORD ONLY. With this selected, you will only hear the input signal whilst actually recording, regardless of the status of the record track's PLAY select key. I.e.:

	STOP	RECORD	PLAYBACK
HEAR INPUT?	NO	YES	NO

RECORD TRACK'S PLAY SELECT KEY ON OR OFF

RECORD ONLY is useful when you only ever want to hear the input signal during record and at no other time. The system will take care of the switching automatically.

RECORD MODE This is a duplicate of the same parameter on the main record page which allows you to select how the recordings you are about to make are stored in the project.

RECORDING

PUNCH MODE This selects how the system will respond if the record track selections are changed while the transport is in record.

Available selections are :

NORMAL This is the default setting. The record track selections can not be changed while the transport is in record.

TRACK KEYS In this mode, the transport responds in the same manner as a conventional MTR. Pressing the REC and PLAY keys will put the system into a 'record-ready' condition waiting for tracks to be punched in from the track select keys. If no tracks are selected at the time the REC and PLAY keys are pressed, the REC key will flash. In this condition, when any of the track select keys are pressed the system will punch into record on the selected track(s) and the REC key will light steadily. When a track select key is pressed again, that track will be punched out of record.

PRIMED In this mode, recording will start immediately on selected tracks when the REC and PLAY keys are first pressed. After this, if new record tracks are selected, the appropriate track select key(s) will flash indicating that the track is in 'record-ready', but recording will not actually start until the PLAY key is pressed again while holding down the REC key. While in record, pressing the track select key of a track that is actually recording will punch that track out of record and back into the 'record-ready' state.

NOTE: The *TRACK KEYS* and *PRIMED* punch modes are only available on 8 track machines (e.g. DD8, DD8plus). The *PUNCH MODE* parameter is not shown on this screen if other machines are being used in the system.

Press EXIT at any time to leave this page and return to the main RECORD screen.

**** NOTES REGARDING TRACK MONITORING DURING RECORDING ****

On analogue multi-track tape recorders, we take seamless punch-in/out for granted. However, this is much more difficult to achieve on hard disk recorders.

The Akai DD/DR-Series have seamless punch-in/out and to achieve this, they play previously recorded material in the background so that, when you punch-out manually, the track is ready to play back immediately with no gap at the punch-out. I.e.:



This means that in most cases, the system will drop in and out of record pretty much like a normal MTR. Usually, on most hard disk recorders, due to disk speed restrictions and SCSI bandwidth, there is a gap of several seconds or more at the point of drop-out. This is not so on the Akai system and it is possible to punch in and out seamlessly on mono and stereo tracks.

However, in order to achieve this, it is necessary to drop tracks because, during recording, the track selected for recording is actually using two tracks - one for the actual recording and the other for the muted track. The Akai DD/DR-Series machines deal with this in a way so that this should not be much of a problem and the way this works is designed to be as transparent as possible. When you enable a track for record, the priority for track dropping is:

FIRST TRACK(S) TO BE DROPPED - Those with no audio on them.

NEXT TRACKS TO BE DROPPED - Any tracks not selected for playback.

NEXT TRACK(S) TO BE DROPPED - Those with the least audio on them (i.e. a track with one or two cues will be dropped before a very busy one).

In normal practice, you should find the process fairly transparent and it's only in very busy projects with a lot of cues across all tracks that you will hear the track dropping take place.

However, when using an MO, because these are slower than hard disks, you may notice tracks dropping. Also, when recording four tracks, there may be gap in monitoring when you drop out of record. The actual recording will be fine - only the monitoring at the point of punch-out will be momentarily affected.

As mentioned, though, under normal circumstances, when recording stereo or mono cues onto either a hard disk or MO, you should not notice this.

RECORDING

AUTO PUNCH-IN/OUT

So far, we have seen how to drop in and out of record manually. It is also possible to automate this using the AUTO-PUNCH key .

The AUTO IN and OUT times are set using the IN and OUT keys. Switching AUTO-PUNCH to ON (i.e. LED lit) will activate the auto punch-in/out function.

To use the AUTO function, locate to a point before the IN time, select a track (or tracks) for record and press PLAY and RECORD together. The RECORD track select key will flash as will the transport keys' REC key as the connected machine(s) play up to the IN time. When the IN time is reached, they will automatically drop in to record and will drop out when the OUT time is reached.

NOTE: One feature of the RE32 is that, because the IN and OUT times are automatically marked at the start and end of a new recording, once you have performed a recording manually, to re-create that time and time again (for example, if you need to keep re-taking the same recording over and over again), you can simply switch AUTO -PUNCH on and the system will then repeatedly punch-in and out automatically at those points.

If the DESTRUCTIVE mode of recording is enabled under these circumstances, old recordings will automatically be deleted from the disk thus preventing the build up of unwanted, useless recordings.

REHEARSE

When the REHEARSE key is switched on, the RE32 will 'pretend' to punch in and out but no audio will be recorded allowing you to rehearse a punch in/out prior to actually doing it.

INPUT ROUTING - ASSIGNING INPUTS TO TRACKS

Depending on the specification of the machines in the system, there may be more tracks than there are inputs so some way of assigning the inputs to tracks is needed. This is achieved from the ROUTE INPUTS page which is accessed by pressing F5/F6 (ROUTE INPUTS) on the main record page.

The first screen shown allows you to select the machine for which you would like to configure the input assignments:

```
ROUTE INPUTS
Machine : 1 (Tracks 1-16)
Press execute to route the selected
machines tracks. The Scroll View keys
will scroll the routing matrix view.
```

Select the required machine using the DATA ENTRY +/- keys. As you select each machine, the display will show the track numbers assigned to that machine to avoid any confusion.

Pressing the EXECUTE will take you to the main routing assignment page. This will vary depending on the type of machine selected.

INPUT ROUTING

INPUT ROUTING - DR16pro

When a DR16pro is selected on entry to the ROUTE INPUTS pages, the following screen will be shown:

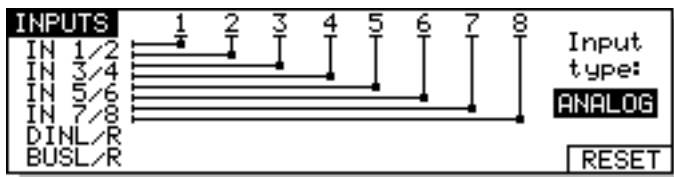

This shows the default routing in a system with analogue inputs selected. If the DR16pro has an optional multi-channel digital interface installed (AES/EBU or ADAT), you can select between ANALOGUE or DIGITAL inputs 1..8 using the DATA ENTRY +/- keys when the cursor is over the INPUT TYPE field.

Inputs may also be routed to tracks using the cursor up/down/left/right keys to move to a matrix point. You then use the DATA ENTRY +/- keys to assign or de-assign accordingly. For example, to route the right channel of the DR16pro's built-in stereo digital interface (DINR) to track 6, move the cursor to 6 using the cursor right key and use the cursor down key to select DINR. The cursor looks like this * and shows you where you are.

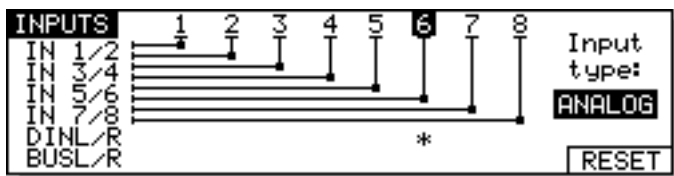

The cursor is shown * and the track number is highlighted.

To route this input to the selected track, press the DATA ENTRY+ key. You will see this screen:

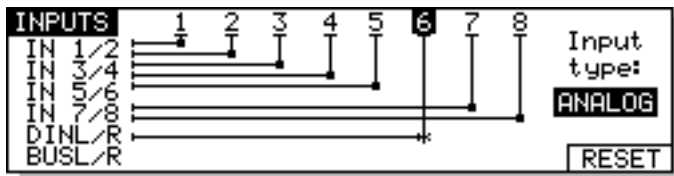

This shows that DINR is now routed to tracks 6.

To route inputs to tracks 9..16, use the SCROLL VIEW keys to view tracks 9..16.

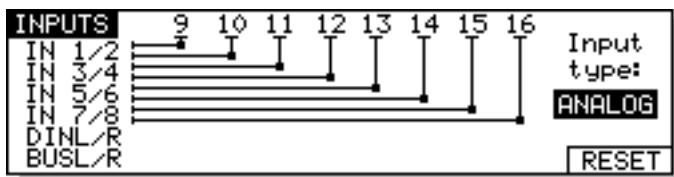

The RESET (F6) key may be used to restore the default routing (input 1 goes to track 1, input 2 goes to track 2 etc..).

INPUT ROUTING - DD8 (or DD8plus)

When a DD8 (or DD8plus) is selected on entry to the ROUTE INPUTS pages, the screen will change to allow control of the input architecture on these machines:

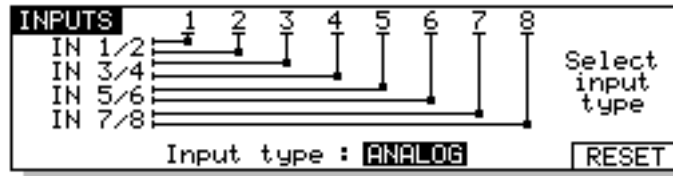

This shows the default routing in a system with analogue inputs. When the cursor is over the INPUT TYPE field, you can select between ANALOGUE or DIGITAL inputs using the DATA ENTRY +/- keys.

Inputs may also be routed to tracks using the cursor up/down/left/right keys to move to a matrix point. You then use the DATA ENTRY +/- keys to assign or de-assign accordingly. For example, to route INPUT 3 to track 6, move the cursor to 6 using the cursor right key and use the cursor down key to select INPUT 3. The cursor looks like this * and shows you where you are. To the right of the screen, the input you have selected and the track you are on is also shown.

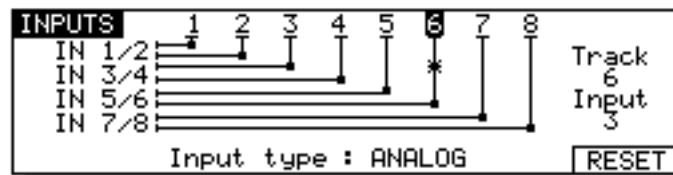

The cursor is shown * and the track number is highlighted. The selected track and input are also shown to the right of the screen - in this case, TRACK 6 INPUT 3. To route this input to the selected track, press the DATA ENTRY+ key. You will see this screen:

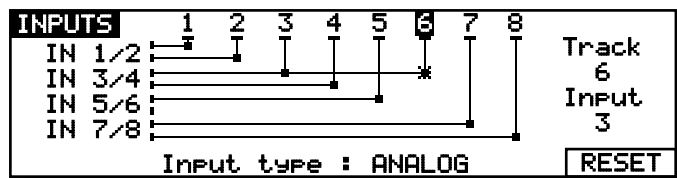

This shows that INPUT 3 is now routed to tracks 3 and 6.

The RESET (F6) key may be used to restore the default routing (input 1 goes to track 1, input 2 goes to track 2 etc..).

INPUT ROUTING

INPUT ROUTING - DD1500

The selection of input routing options on the DD1500 depends very much on the options you have installed in the system. In a basic system with no ADCs connected (I.e. the only inputs you have are the digital inputs A and B), the default assignment would be:

INPUTS	TO TRACKS							
DIGI A L/R	1	2	5	6	9	10	13	14
DIGI B L/R	3	4	7	8	11	12	15	16

If you add one DD1500a to the system with just two stereo analogue inputs, these would be automatically assigned as

INPUTS	TO TRACKS			
ADC 1L	1	5	9	13
ADC 1R	2	6	10	14
ADC 2L	3	7	11	15
ADC 2R	4	8	12	16

The digital inputs A and B may also be assigned if you wish but, in this case, the analogue inputs would take priority in the routing.

Of course, should you add more inputs (be they digital or analogue), the system will assign them automatically for you but you may re-assign them as you wish.

With this default setting, you may record using a normal 4- or 8-group output track laying mixer and assign mixer channels to tracks from the mixer just as you would with a normal MTR with no need to worry about having to set any special input routing. However, if you do wish to route inputs within the DD1500, this is also possible.

When a DD1500 is selected on entry to the ROUTE INPUTS pages, the screen will display something like this:



This shows the default routing in a system with no analogue inputs, only the standard digital inputs A and B.



This shows the default settings for a system fitted with a DD1500a comprising one AD4 analogue input board.

Inputs can be assigned to tracks 9..16 by pressing the SCROLL VIEW key. You will see this screen display:

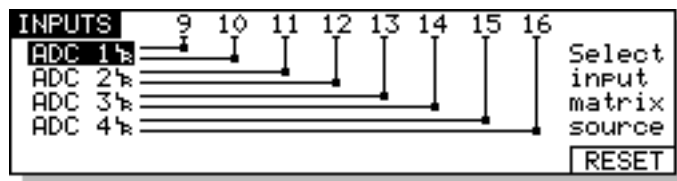

This shows the default assignment for a system with eight analogue inputs with each input being routed to tracks 9..16.

With the cursor to the far left of the screen in the INPUTS column, you may assign inputs to tracks using the DATA ENTRY +/- keys. For example, to assign digital input A to tracks 1 and 2 instead of the analogue inputs shown here, press the DATA ENTRY+ key to receive this display:

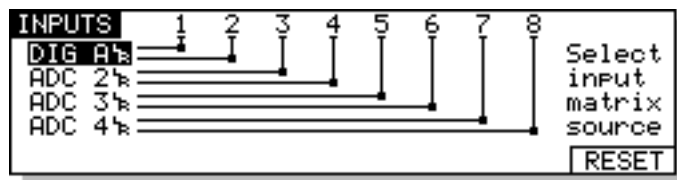

Any pair of inputs can be assigned to tracks in this way.

Inputs may also be routed to tracks using the cursor up/down/left/right keys to move to a matrix point. You then use the DATA ENTRY +/- keys to assign or de-assign accordingly. For example, to route ADC 1R to track 6, move the cursor to 6 using the cursor right key and use the cursor down key to select INPUT ADC 1R. The cursor looks like this * and shows you where you are. To the right of the screen, the input you have selected and the track you are on is also shown.

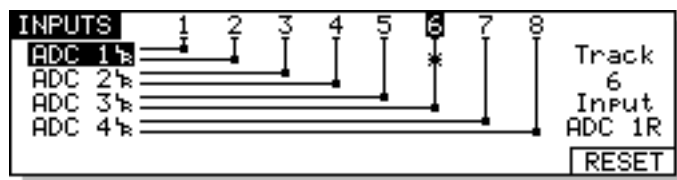

The cursor is shown * and the track number is highlighted. The selected track and input are also shown to the right of the screen - in this case, TRACK 6 INPUT ADC 1R. To route this input to the selected track, press the DATA ENTRY+ key. You will see this screen:

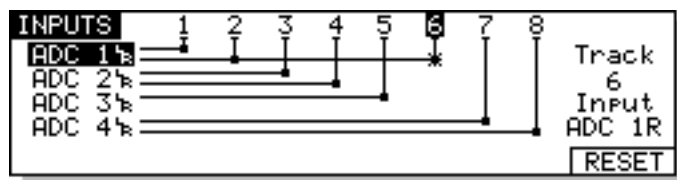

This shows that INPUT ADC 1R is now routed to tracks 2 and 6.

Any combination of inputs may be routed to tracks in this way (although two inputs may not be routed to one track). Don't forget that to route inputs to tracks 9-16, you should SCROLL VIEW keys.

INPUT ROUTING

Should you wish to reset the input routing to the default setting, press the RESET key. The input selection and track routings you make can be saved as part of the system settings when you save them (see SYSTEM - SETTINGS).

Of course, depending on your system, you may have more or less analogue and/or digital inputs. The procedure is exactly the same, however, regardless of system configurations.

RECORDING DIGITALLY

When recording digitally, the machine must synchronise to that digital audio signal's wordclock. If you have selected a digital input to record through in the ROUTE INPUT page, the input will usually be selected automatically as the wordclock source by the machine as soon as you select a track routed to that input for record.

If, for some reason, you select to record digitally but a digital input is not connected, as soon as you try to select a track (or tracks) for record, you will get the prompt:



You will not be able to select any tracks for record until the problem has been fixed. Please check your digital audio connections.

This message will also be shown if the digital audio signal gets disconnected or you select another digital input that has no connection.

If you are in the process of recording when this happens, the system will stop recording and playback. Please check your connections.

PLAYING BACK AUDIO MATERIAL

There really isn't much to say about playing audio - simply press the PLAY key!! Of course, in order to hear anything, you must select tracks for playback using the TRACK SELECT PLAY keys at the top of the RE32's panel. When tracks are selected for play (i.e. their keys are lit), audio is shown in blue blocks on the monitor with a grey waveform. If a track is not selected for play (the keys are not lit), the monitor will display them as light grey blocks with slightly darker grey waveforms. In many ways, operation is much the same as for any standard MTR with the added bonus of a scrolling 'track sheet' on the external monitor.

The RE32's transport keys are designed to emulate those on an MTR as closely as possible. The keys are:

- ▶ This is the PLAY key.
- This is the STOP key and will stop playback, recording, rewind and fast forward.
- ▶▶ This is fast forward. Pressing it once gives x 10 play speed; pressing it again gives x 100 play speed. Press it again to fast forward at x 10 play speed.

When ▶▶ is pressed during play, the system will fast forward with 'tape chatter' just like a standard MTR. In this case, only x 5 play speed is possible.
- ◀◀ This is rewind. Pressing it once gives x 10 play speed; pressing it again gives x 100 play speed. Press it again to fast forward at x 10 play speed.

When ▶▶ is pressed during play, the system will rewind with 'tape chatter' just like a standard MTR. In this case, only x 5 play speed is possible.
- REC This key allows you to drop in and out of record just like a normal MTR. Press ▶ plus REC together to drop in and press ▶ (or □) to drop out of record. Of course, in order to record, you must first select tracks to record using the RECORD select keys on the upper panel.

The RE32 offers other play options not available on most tape machines or hard disk recorders, however.

For example, there is REVERSE PLAY. Pressing SHIFT+PLAY will cause the system to play backwards. This is a technique used a lot in film applications where mixing engineers actually mix down backwards in order to save time. However, please note that you cannot record backwards.

Above the main play keys is a row of special play keys. These are:

- PLAY TO This will play up to the NOW time. I.e.:

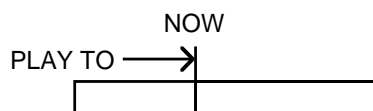

This is useful for checking things prior to editing (i.e. to find a good edit point) but may also be used for checking things on the NOW time generally.

PLAYBACK

The default PLAY TO time is 1 second but you may change this by pressing SHIFT+PREROLL to go to the PREROLL SETUP page and then PLAY TIMES (F1/F2) to go to this screen:

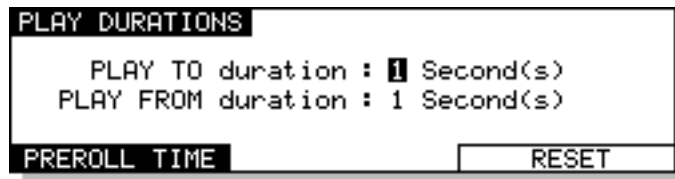

You may set the PLAY TO duration to a maximum time of 9 seconds. As this function is used almost exclusively for quick auditioning, times in excess of this are considered unnecessary.

You can also set the PLAY FROM duration here as well. You may reset the play durations to the default settings of 1 second by pressing RESET (F5/F6).

PLAY FROM

This plays from the NOW time for a specified duration. I.e.:

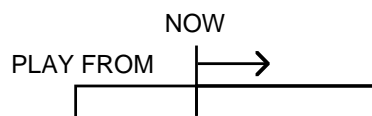

The PLAY FROM duration can be set by pressing SHIFT-PREROLL as above (setting PLAY TO).

NOTE: You will find that if PLAY durations are set longer than the default 1 second setting, play response will be marginally slower.

PLAY IN>OUT

This will play from the IN point to the OUT point. I.e.:

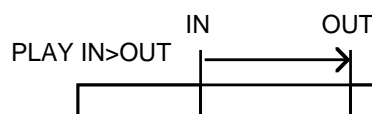

This is useful for checking edits but can also be used for checking the last recording you made. Because the RE32 automatically places the IN and OUT times at the start and end of a new recording, you may use PLAY IN>OUT to check it immediately after recording.

You will find these keys very useful for checking things. With their default values of 1 second, their play response time is very fast indeed making auditioning and checking very quick and convenient.

The final three keys in the transport section are:

LOCATE	This is used to locate to new positions in the GRID. It is described later in the LOCATOR section.
STORE LOCATE	This is used to store locate times. It is described later in the LOCATOR section.
INPUT MON	This key causes all tracks which are armed for recording to temporarily switch to monitor their input source. Usually, the system's auto-monitor function causes playback audio to be heard while the transport is in motion and any armed record inputs to be heard while the transport is stopped or recording. This key temporarily overrides this switching so that the input audio can be heard at any time.

MUTING TRACKS

Tracks are muted simply by turning the appropriate PLAY track select keys off. When muted, the cues are shown in grey on the external monitor.

SOLOING A TRACK

There is no dedicated SOLO key on the RE32. This is not an oversight on our part as the same thing can be achieved using ALL PB and ALL MUTE. To solo a track, press ALL MUTE (SHIFT+ALL PB) and select the track(s) you wish to solo. To 'un-solo' the track(s), press ALL PB.

PLAYBACK

GROUPING TRACKS

It is also possible to group up to ten different combinations of tracks together. Actually, this is not specifically a playback feature because you may also group tracks together for record and/or edit.

To store a group, assuming you have selected tracks as necessary, press the GROUP STORE key (SHIFT+GROUP). The following screen will be shown:

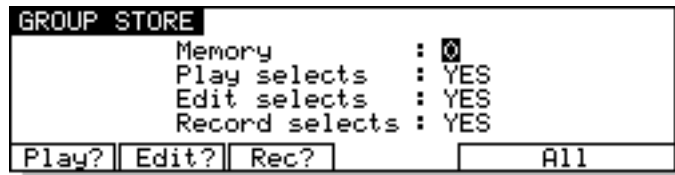

```
GROUP STORE
Memory      : 0
Play selects : YES
Edit selects : YES
Record selects : YES
Play? | Edit? | Rec? | All
```

The parameters on this screen are:

- | | |
|----------------|---|
| MEMORY | This allows you to select which GROUP memory you want to store (0..9). |
| PLAY SELECTS | When set to YES, this allows the current play track selects to be stored in the GROUP memory. |
| EDIT SELECTS | When set to YES, this allows the current edit track selects to be stored in the GROUP memory. |
| RECORD SELECTS | When set to YES, this allows the current record track selects to be stored in the GROUP memory. |

After selecting the GROUP memory and the appropriate tracks for play, record or edit press the EXECUTE key to save the selections.

Groups are recalled simply by pressing the GROUP key to select the GROUP RECALL screen and selecting the required group memory

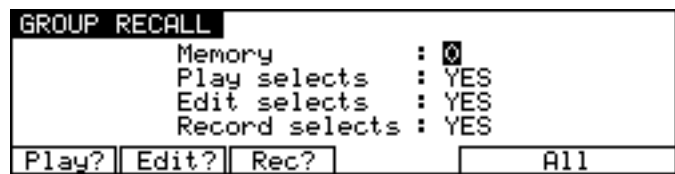

```
GROUP RECALL
Memory      : 0
Play selects : YES
Edit selects : YES
Record selects : YES
Play? | Edit? | Rec? | All
```

The GROUP keys are very useful for storing combinations of PLAY and RECORD. They are also particularly useful when editing, especially when copying awkward track combinations from one to another (for example, tracks 1, 3, 6 to tracks 2, 7, 8).

AUTOLOCATOR

However, you often need to go to very specific points in a project. To facilitate this, the RE32 has a powerful autolocator that allows you to store up to 100 numbered locate memories, 100 'grab' markers as well as being able to locate to the start, the end and the IN, SYNC and OUT points. You may also locate to the next and previous cues and you may also locate directly to timecode values. Pressing the LOCATE key will display this screen:



LOCATING TO THE START OR END OF A PROJECT

To locate to the START or END of a project, simply press LOCATE, START (F5) or LOCATE, END (F6) and you will be taken directly to these positions. You can also locate to the START of a project by pressing SHIFT +<<<, or to the END of a project by pressing SHIFT +>>>.

LOCATING TO THE NEXT OR PREVIOUS CUES

You may also go sequentially to the start and end of the previous or next cues by pressing PREV Q (SHIFT+PLAY TO) or NEXT Q (SHIFT+PLAY FROM).

The logic for cue selection is that you will only go to the cues on the tracks selected for edit. If only one track is selected for edit, you will only go to the cues on that track. If one or more tracks are selected for edit, you will go to each one on each track in turn. If no tracks are selected for edit, only PLAY, you will go to every cue on all tracks in turn. If no tracks are selected for PLAY (i.e. all track select keys are off), the function does not work.

LOCATING TO TIMECODE POSITIONS

You may locate to a timecode position using the numeric keypad. For example, to locate to 01:12:13:23, press LOCATE, 1,00,12,00,13,00,23,00, ENT where 00 is the 'double zero' key on the keypad.

NOTE: If you previously located to a locator memory number, you may have to press F1 to select TIME.

LOCATING TO LOCATOR MEMORIES

To locate to a previously stored locate memory, press LOCATE, F2 (MEMORY) and the appropriate number 0-99 on the keypad followed by ENT or EXECUTE (see STORING LOCATE MEMORIES).

Locate points are unique to a project and all locator memories are saved when you save the project and are recalled when the project is subsequently re-loaded.

STORING LOCATE MEMORIES

To store locate memories, press STORE. You will see this screen:

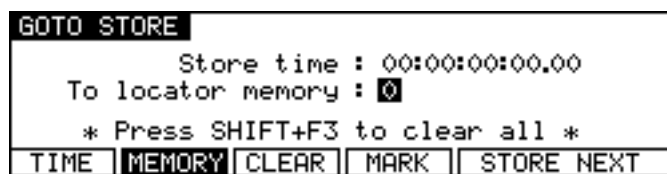

The STORE TIME field shows the current NOW time when you enter this page. However, by pressing F2 - TIME - you may change this time here prior to storing it but this will not affect your position and you will stay on the current NOW time. For example, if you know you want to store 00:05:00:00.0 in a locator memory, you may enter this value here without moving from the current NOW time.

AUTOLOCATOR

There are actually two ways to store locate memories. One allows you to store single memories and leave the page, the other allows you to stay in the page and store multiple locate memories without having to keep re-entering the STORE page.

To store a single memory, locate to the time you want to store using LOCATE, TIME and then press STORE, type in a locate memory 0-99 from the keypad and press ENT or EXECUTE.

To store multiple locate memories, enter the STORE page and enter the first memory number 0-99 you want to store and then press STORE NEXT (F5/6). The memory will be stored and TO LOCATOR MEMORY number will automatically be incremented to the next number so you can store the next number simply by pressing STORE NEXT again. This allows you to store locate positions 'on the fly' during playback. For example, with this page open and select a suitable memory location. Now start playback and, while playing back, pressing STORE NEXT will store the memory locations incrementally. You may also do this whilst jogging or using the NEXT/PREV CUE functions, etc.. Pressing EXIT or EXECUTE will close this screen and return you to the main screen.

When you store locate memories, they are shown on the scroll bar beneath the GRID as a white triangle:



You may also mark locate points using the GRAB key. Simply pressing the GRAB key will mark a grabbed locate point and it will be shown as a grey vertical line in the scroll bar beneath the GRID:



You may 'grab' the points at any time when the system is stopped or, in fact, when playing back. These markers are particularly useful for marking locate points of interest you may wish to come back to later (for example, sections in a piece of music, mistakes in a vocal track, etc.) and up to 100 grab points may be marked in one project. They can be converted to locate memories simply by locating to them (holding down GOTO plus the numeric keypad's -/< or +/> key) and then storing a locate memory as described above.

When this page is open, pressing EXIT will return you to the main work page.

CLEARING LOCATE MEMORIES

Sometimes, it may be necessary to clear (delete) one or more (or all) locator memories. There is no real benefit to this other than reducing clutter in the scroll bar by removing locate memories that are no longer required.

CLEARING SINGLE LOCATE MEMORIES

To clear a single locate memory, press SHIFT+GOTO(STORE), select the locator memory you wish to clear and press F3/F4 - CLEAR. If you make a mistake, simply press STORE again to re-mark it.

CLEARING ALL LOCATE MEMORIES

To clear *all* locate memories, press SHIFT+STORE and then SHIFT+F3. You will receive this prompt:

```
Clear entire locator?
```

Press EXECUTE to clear or EXIT to abort.

CYCLE

With CYCLE switched on, the system will play repetitively between the IN/OUT points you have marked.

This may also be used in combination with the PRE-ROLL key (see below) and the AUTO-PUNCH function.

With PRE-ROLL switched ON, the repeat will play for a time before the IN time as set by the PRE-ROLL. It will then play for a time after the OUT time as set by the PRE-ROLL. For example, with a PRE-ROLL of 5 seconds, the cycle will play from 5 seconds before the IN time and for 5 seconds after the OUT time. I.e.:

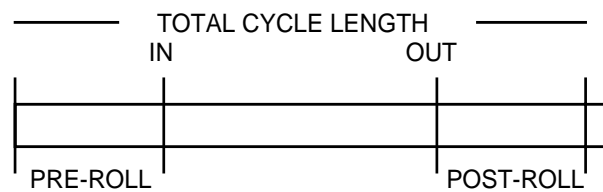

It is also possible to use this with the AUTO punch in/out function.

For example, with CYCLE, AUTO and PRE-ROLL on, you can automate your recordings very conveniently. The PRE-ROLL will cause playback to commence at a set amount before the IN time and will then play back for the same amount after the OUT time, punching in and out at the IN/OUT times accordingly. In this way, you can set a 'run in' and a 'post-roll' to an auto punch in/out.

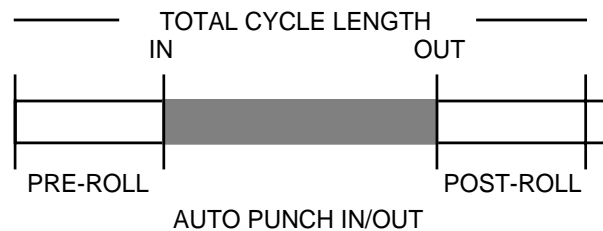

NOTE: The CYCLE function does not offer 'seamless' looping and there will be a small gap in playback as the connected machines cycle back to the IN point. The exact length of the gap depends on the IN>OUT length.

AUTOLOCATOR

PRE-ROLL

The PRE-ROLL key allows you to set an offset to locate times. This offset is then added to all locate time points you go to. For example, with a pre-roll of 3 seconds, if you locate to 00:01:00:00.0, you will actually locate to 00:00:57:00.0. Similarly, with a 3 second pre-roll, you would locate three seconds before the IN time in the event of you pressing GOTO IN. Similarly with GOTO OUT or SYNC. Locating to a locate memory would have the same effect.

The principle use of PRE-ROLL is when synchronising mechanical tape players (VTRs, MTRs, etc.) to the Akai system. Because mechanical devices need a certain amount of time to get up to speed, it is necessary to locate to a point a few seconds before where you really want to be so that the external devices get up to sync by the time you reach the actual locate point.

The PRE-ROLL time is set by pressing SHIFT+PRE-ROLL(SET). You will receive this screen:

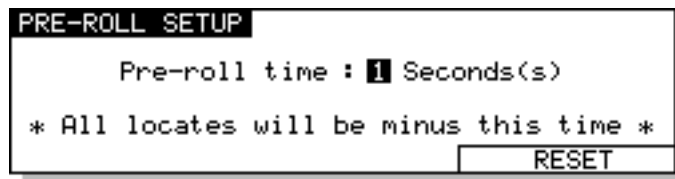

Simply set the pre-roll time you require using the DATA ENTRY+/- keys or more directly from the numeric keypad. If you get confused in this complicated screen, press RESET (F5/F6) to reset the pre-roll time to the default time of 1 second!!

When PRE-ROLL is switched on, all locates will be minus the time set here.

You can also press SHIFT + STOP at any time to relocate the transport to its current position minus the PRE-ROLL time.

EDITING

In this section we will be looking at editing on the RE32. Before looking at the edit operations in detail, we will first describe the functions of some of the keys associated with editing in general.

EDIT KEY

Pressing the EDIT key will display the main edit page. The IN, SYNC and OUT times are shown as is the IN/OUT length.

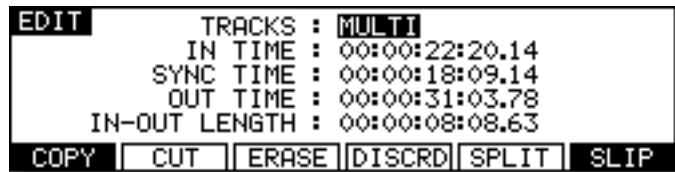

The 'soft' keys F1-F6 are used to select the available edit functions which change according to the edit mode selected. Sometimes these are used to go to other pages or call other functions, sometimes they are 'action' keys that perform specific functions. We will look at more of their functions during the course of this section.

EXIT KEY

The EXIT key is a 'cancel' or 'abort' key and will take you out of any situation without committing it.

UNDO KEY

The RE32 offers multi-level undo allowing you 'repair' an edit should you make a mistake. To undo a mistake, simply press UNDO. If you have been experimenting with something and have carried out a series of edits, you may undo them sequentially by repeatedly pressing UNDO.

REDO (SHIFT+UNDO)

If you undo something and wish to revert back to the previous version, pressing SHIFT+UNDO (REDO) will redo the undo. In the event of you undoing a few steps, pressing REDO several times will sequentially undo the undos.

EXECUTE KEY

Most editing functions on the RE32 are completed using EXECUTE. In an action where it necessary to press EXECUTE to complete it, the key's LED will flash and you should press EXECUTE to complete the action. Whenever this LED is flashing, EXIT will always abort the action without committing it.

IN KEY

This key allows you to mark an IN time for an edit. When you mark an IN time, a vertical green line is shown on the monitor and the IN TIME is shown on the LCD. This indicates the start of an edit.

SYNC KEY

This allows you to mark a sync point in an edit or a cue and this can be used for syncing up material with other aural or visual events. For example, it could be used to precisely back-time a reverse reverb effect to end at a specific point in a drum part on another track. When you mark a SYNC point, a yellow vertical line is shown on the monitor. The time is also shown on the LCD.

OUT KEY

This allows you to mark an OUT time for an edit. When you mark an OUT time, a green vertical line is shown on the monitor showing you the position of the OUT time. The OUT time is also shown on the LCD. When an edit region is marked in this way, the area in between the IN and OUT marks is highlighted green and the waveform (if selected for display) is shown in black on the monitor on the track(s) selected for EDIT. The IN to OUT length is shown on the LCD. This region may now be subjected to the editing functions on the RE32 such as COPY, CUT, NUDGE, etc..

NOTE: Although the OUT time can be placed before the IN time, this is not a valid edit region. Should this happen and you try to do an edit, the LCD will display the prompt.



The same message will also be displayed if you try to do an edit and an IN and OUT time are at the same time.

You may also use IN, SYNC and OUT to select whole tracks for editing.

TO SELECT A WHOLE TRACK - press SELECT TRK (SHIFT+SELECT Q). The track(s) selected for editing will be shown green from the first to the last cue.

TO SELECT A TRACK FROM THE IN POINT TO THE END - press IN (to mark the IN time) and then, whilst holding the IN key, press OUT. This will select the whole of the track(s) from the IN time to the end. The track(s) selected for editing will be shown in green from the in point to the end of the track on the monitor screen.

TO SELECT A TRACK FROM THE OUT POINT BACK TO THE START - press OUT and then, whilst holding OUT, press IN. This will mark the track(s) from the start of the track to the OUT time. The track(s) selected for editing will be shown in green from the OUT time back to the first cue.

TO SELECT A TRACK FROM THE SYNC MARK TO THE START OR END - press SYNC and then, whilst holding SYNC, press IN. This will mark the track(s) from the SYNC marker the start of the track(s). Pressing the SYNC key and then, whilst holding SYNC, pressing the OUT key will mark the track(s) from the SYNC marker to the end of the selected track(s).

The SYNC and OUT keys can also be used when pasting or inserting to paste/insert to specific sync points you may have marked or to back-time an edit. We will look at this when we come to examine PASTE and INSERT.

SELECT Q KEY

The SELECT Q key marks the IN and an OUT at the start and end of a cue. This saves you having to specifically mark the IN and OUT manually.

Typical operation is to line up the cue you are interested in on the NOW time, select the track for EDIT and press SELECT Q. The cue will be highlighted green and the SYNC mark will be placed at the point at which it is selected. I.e.:

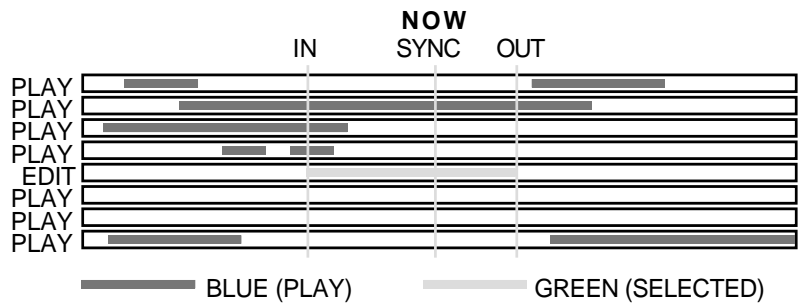

EXAMPLE A - SELECTING A SINGLE CUE

This also works for stereo cues. Line the cues you are interested in on the NOW time, select both relevant tracks for EDIT and press SELECT Q. The IN and OUT will be placed at the start and end of the cues on both tracks and the SYNC marker placed at the point of selection. I.e.:

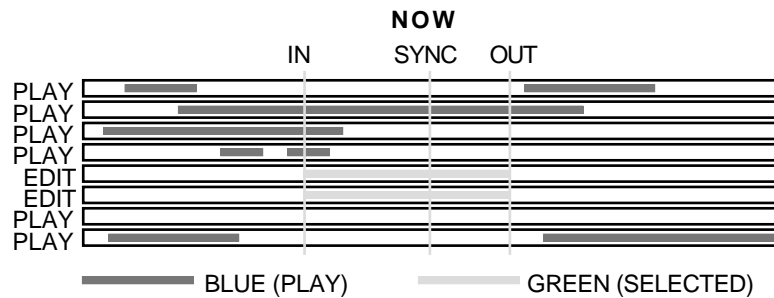

EXAMPLE B - SELECTING A STEREO CUE ACROSS TWO TRACKS

You may also select multiple cues in this way. In this case, the IN and OUT will be placed at the start and end of the longest cue(s) and anything that falls within that edit region will be selected. For example, imagine that you have this situation:



Pressing SELECT Q will give this result:

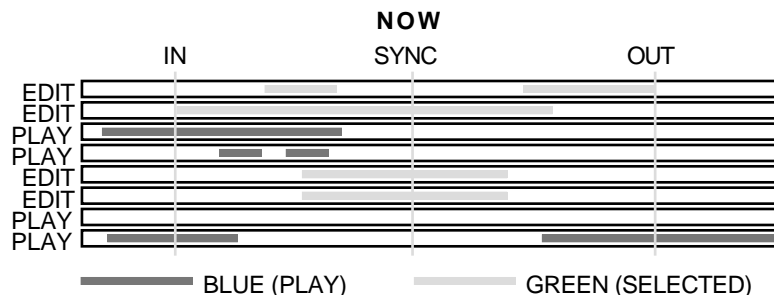

EXAMPLE C - SELECTING MULTIPLE CUES

When multiple cues are selected (i.e. several tracks in edit), all selected cues are highlighted green. If you turn any of the selected tracks off, those cues are de-selected but, if you turn them back on again, they are re-selected. To select other cues on other tracks, simply turn them on for EDIT.

Cues selected using SELECT Q may be subjected to all the various editing functions available but without the need to specifically mark IN and OUT times.

It must be said that multiple cue selection is not the prime use of SELECT Q. Its principle use is to select a single cue on one track (or stereo cue on two tracks) for editing (copying, cutting, erasing, slipping, nudging, timestretching or for setting the level and fade up/down parameters). However, you can, if you wish, use SELECT Q for selecting multiple cues in a larger edit region (for example, for setting the levels or a common fade down time for a group of cues). Although this can be achieved by specifically setting the IN and OUT times manually, you may find it saves you time to use SELECT Q.

MULTI- MACHINE EDIT

Multi-machine edit mode provides a quick and convenient method for copying audio from one region to another on the same track(s). For example, it can be used to copy the chorus of a song from one position to another. The only restriction in this mode is that audio cannot be moved from one track to another. For edits that involve moving audio from one track to another, SINGLE-MACHINE EDIT should be used as described in a later section.

MULTI-MACHINE EDIT is selected by pressing the EDIT key and then selecting MULTI in the TRACKS field. You will see the following display similar to this:

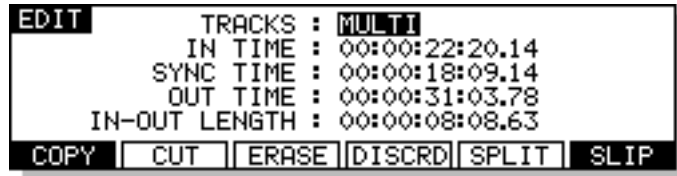

The soft keys show the edit functions that are available.

COPYING A REGION

This allows you to copy a selected audio region on any combination of tracks in the system to a new location on the GRID.

First, mark the region you want to copy using the IN and OUT keys and select the tracks containing audio you wish to copy using the EDIT TRACK SELECT keys. Cues within the marked region will be shown in green on the display to show that they are selected.

Next, press the COPY (F1) key. The audio region selected will 'pop-out' of the GRID and will be shown as a 'ghost' image in red on top of the original cues:

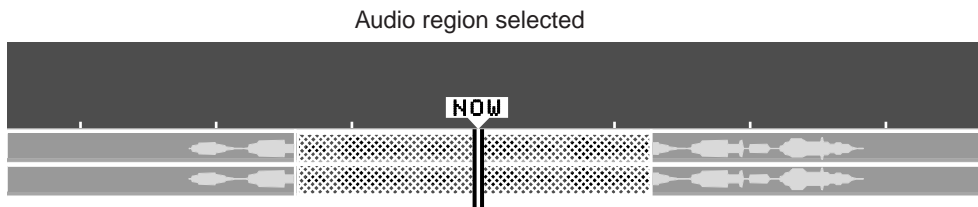

Now, you can use any of the transport controls to move selected region to the position you want to copy it to. You can use PLAY, REW, FF etc., as well as LOCATE functions and then the JOG wheel to 'fine tune' your selection. As you move to new areas in the GRID, the selected region will remain as a 'ghost' image referenced to the NOW time:

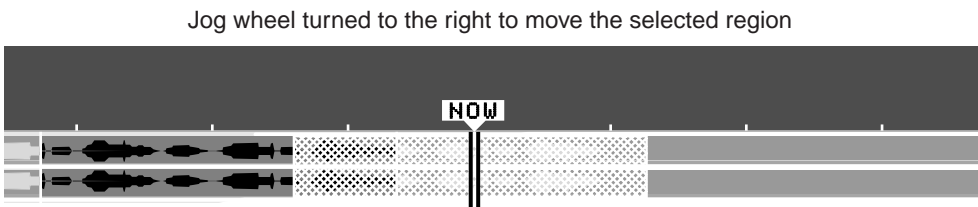

At the time you press COPY (F1) to select the audio region, you will also notice that the LCD changes to show the following options:

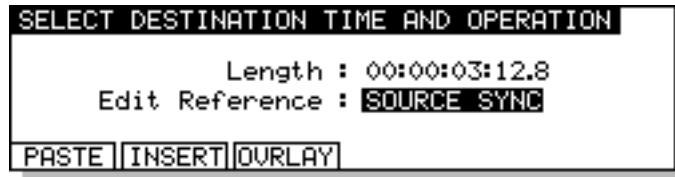

The parameters on this page show:

LENGTH This is the length of the audio region selected

EDIT REFERENCE This selects how the audio region selected is referenced to the current NOW time. The options are:

SOURCE SYNC- Referenced to the NOW time at which the audio region was selected:

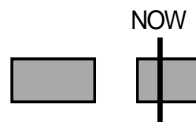

SOURCE OUT- Reference to the end of the selected audio region:

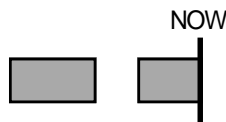

SOURCE IN- Referenced to the start of the selected audio region:

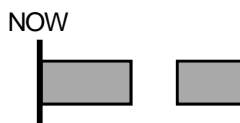

The soft keys may be used to choose how the selected audio region will be copied back into the GRID at its new position.

MULTI-MACHINE EDITING

MULTITRACK PASTE

Pressing PASTE (F1) will paste the selected region *over* any material at the current NOW time. You will note that any gaps in the material being pasted will be pasted over any material that exists at the paste point. For example:

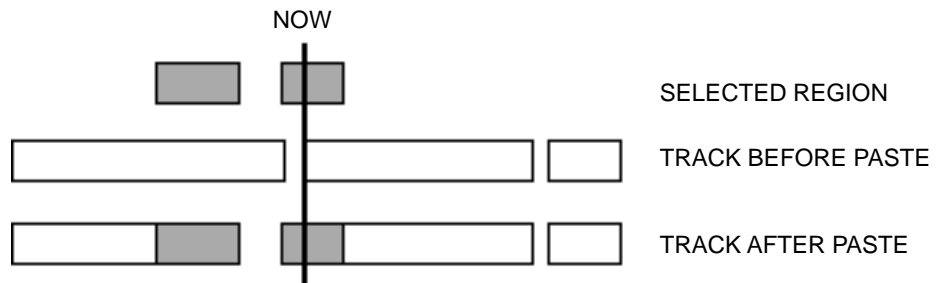

MULTITRACK INSERT

Pressing INSERT (F2) will insert the selected region at the current NOW time and will cause any audio after the insert point to be shifted.

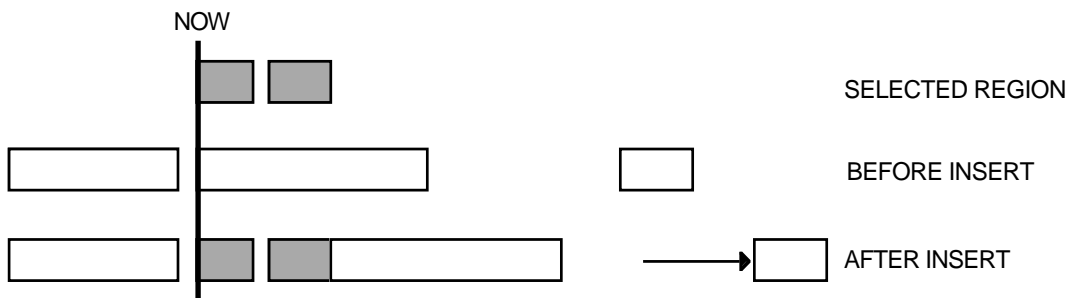

MULTITRACK OVERLAY

Pressing OVRLAY (F2) will paste the selected region over any existing material at the point of pasting but, if there are any gaps in the material being pasted, these are 'transparent' and will reveal any audio 'underneath'. For example:

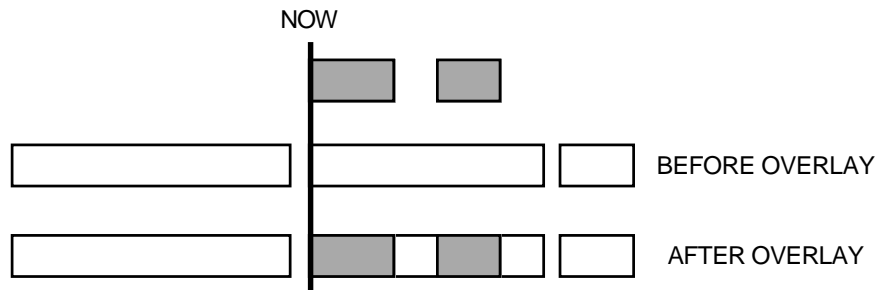

Compare this with PASTE where the gap in the pasted material obscures the material beneath:

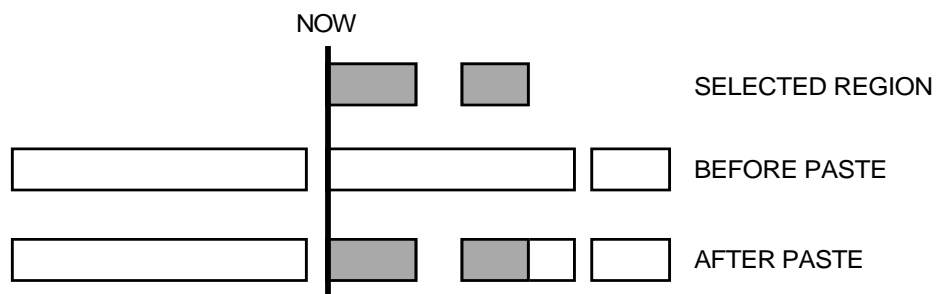

When using PASTE, the area 'underneath' the gap being pasted over would not be heard whereas with OVERLAY it would.

MULTI-MACHINE EDITING

CUT

This allows you to remove a selected region of audio copy on any combination of tracks from the GRID and close the gap(s) thus created, shifting all audio after the edit accordingly. For example:

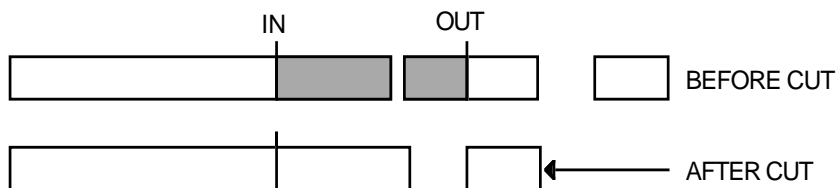

First, mark the region you want to cut using the IN and OUT keys and select the tracks containing audio you wish to remove using the EDIT TRACK SELECT keys. Cues within the marked region will be shown in green on the display to show that they are selected.

Next, press the CUT (F2) key on the main MULTI-MACHINE EDIT page. The audio region selected will be removed from the GRID and subsequent audio shifted accordingly.

ERASE

ERASE is similar to CUT except that it will remove the currently selected region but will keep any gap(s) thus created.:

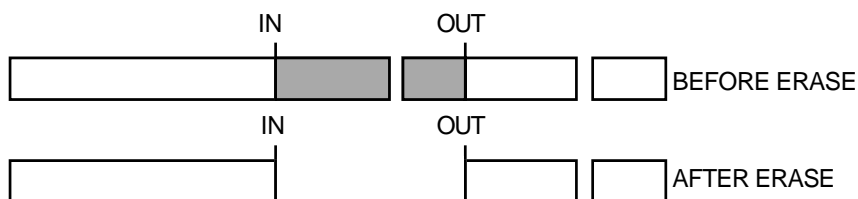

First, mark the region you want to cut using the IN and OUT keys and select the tracks containing audio you wish to remove using the EDIT TRACK SELECT keys. Cues within the marked region will be shown in green on the display to show that they are selected.

Next, press the ERASE (F3) key on the main MULTI-MACHINE EDIT page. The audio region selected will be removed from the GRID.

DISCARD

The DISCARD function will discard material on either side of the selected region but will not slip any subsequent audio:

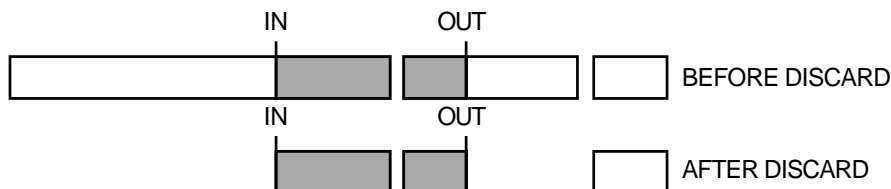

First, mark the region you want to cut using the IN and OUT keys and select the tracks containing audio you wish to remove using the EDIT TRACK SELECT keys. Cues within the marked region will be shown in green on the display to show that they are selected.

Next, press the DISCARD (F4) key on the main MULTI-MACHINE EDIT page. Audio material on either side of the selected region will be removed from the GRID.

The main use for DISCARD is to get rid of any rubbish from cues before a certain point and after a certain point.

SPLIT EDIT

As its name suggests, SPLIT allows CUES to be split in two. Each cue may then be edited separately. I.e.

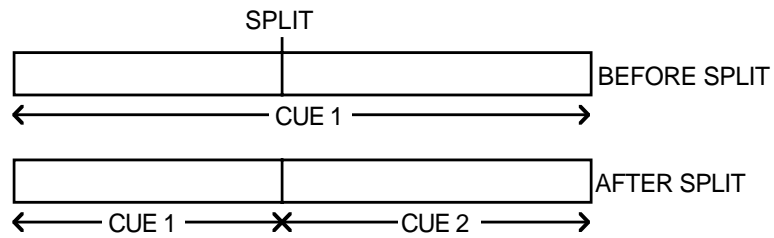

The process can be repeated almost indefinitely within one cue, splitting it up into smaller sections each time. EXECUTE is not required for SPLIT CUE.

The SPLIT function is executed by pressing SPLIT (F5) on the main MULTITRACK EDIT page:

```
EDIT   TRACKS : MULTI
        IN TIME : 00:00:22:20.14
        SYNC TIME : 00:00:18:09.14
        OUT TIME : 00:00:31:03.78
        IN-OUT LENGTH : 00:00:08:08.63
COPY   CUT   ERASE DISCRD SPLIT SLIP
```

As with other MULTITRACK EDIT functions, SPLIT may be used on any combination of tracks in the system and can be useful to chop up individual sentences and phrases in a dialogue recording or to split a music project into smaller sections.

SINGLE MACHINE EDIT

Multi-machine edit mode provides a quick and convenient method for copying audio from one region to another on the same track(s). However, it is restricted in that audio cannot be moved from one track to another. This is to prevent you trying to copy audio from a track on one machine to a track on a different machine. For edits that involve moving audio from one track to another track on the same machine, SINGLE-MACHINE EDIT can be used. This uses the EDIT CLIPBOARD as a temporary storage place for the audio regions being edited.

SINGLE-MACHINE EDIT is selected by pressing the EDIT key and then selecting the range of tracks you wish to edit in the TRACKS field. The ranges shown in the TRACKS field correspond to the tracks assigned to each machine in the system (1-16, 17-32 etc..). When a TRACKS selection for a single machine has been made, you will see the following display:

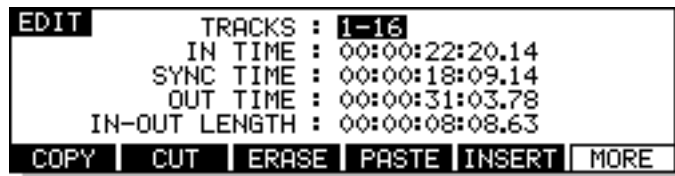

The soft keys show the edit functions that are available, with MORE (F6) being used to scroll to more functions. Before looking at the edit functions in details, we will first look at the EDIT CLIPBOARD which is displayed while in SINGLE-MACHINE EDIT.

EDIT CLIPBOARD

The EDIT CLIPBOARD can be regarded as a temporary storage place for audio cues. It can hold up to ten clips, 0-9, which are available for pasting and inserting into a project at any time. When SINGLE-MACHINE EDIT is selected, the clipboard is automatically displayed at the right hand side of the VGA monitor in the associated MACHINE BOX and here you can see the edits you have placed in it.

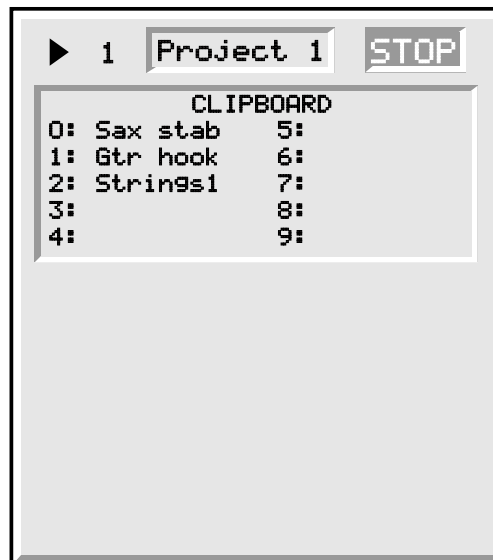

When you copy, cut or erase an edit to the clipboard, the name of the cue is shown in the clipboard number you have used. You may, if you wish, give an edit a different name prior to placing it in the clipboard so that you can see at a glance what is in the clipboard. When an edit is re-named in this way, the new name will be used when you subsequently come to paste or insert the edit later on.

In the case where the IN/OUT markers straddle several cues that have different names, the name of the first cue selected will be shown in the clipboard. When that edit is subsequently pasted or inserted back into the project, the original name will be shown.

The EDIT CLIPBOARD is a very convenient way of having edits readily available for immediate access at any time. In a way, if you consider the analogy of tape editing, the clipboard is the digital equivalent of putting certain useful edits to one side and hanging them up for use later on.

CLIPBOARD 0 is the default clipboard and unless another clipboard number is specifically selected, this is the clipboard number you will copy, cut or erase to or paste or insert from.

Using the clipboard is designed to be very quick and easy. At its simplest level, to copy an edit to, say, clipboard 5, simply mark the region you are interested in, press COPY, 5, EXECUTE. To paste that back in elsewhere, press PASTE, 5, EXECUTE. Prior to copying it to the clipboard you could give it a name and prior to pasting it in, you can audition it to check you have selected the correct one.

You will find the EDIT CLIPBOARD an invaluable aid when editing. We will now move on to look at the edit functions available from the soft keys in SINGLE-MACHINE EDIT.

COPY TO CLIPBOARD

This will copy the edit region within the IN/OUT marks or will copy the currently selected CUE(s) to the clipboard. Pressing COPY (F1) from SINGLE-MACHINE EDIT will display this screen:

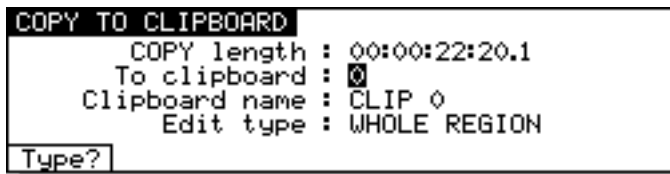

You can see the length of the edit region/cue(s) in the COPY LENGTH field. You cannot access this field and is shown for information purposes only.

When you press COPY, the EXECUTE key's LED will flash. Simply pressing the EXECUTE key at this point will copy the edit region/cue(s) to the default edit clipboard 0 and will also close this screen. If you wish, however, you may like to copy the current edit region/cue(s) to one of the numbered edit clipboards 1-9. To do this, press one of the number keys 1-9 on the numeric keypad before pressing EXECUTE. The clipboard number will be shown on the LCD. Pressing EXECUTE will copy the edit region/cue(s) to the selected clipboard. For example, to copy the edit to clipboard 5, press COPY, 5, EXECUTE.

If you wish, prior to copying the edit to a clipboard, you may give it a name for easier reference later on. If you do not name it, it will take the name of the currently selected cue or the cue within the edit region. If multiple cues are selected, the name of the first cue will be shown in the selected clipboard. However, when you come to paste this back in, the other cues in the region will retain their original names.

If you have a PS/2 keyboard attached to the RE32, you can name the edit prior to copying it. As you type the name on the keyboard, the CLIPBOARD NAME field will 'open':



You may enter a name of up to ten characters. Press RETURN to complete the naming process and RETURN again to complete the edit.

NOTE: if you rename a cue when copying it will use this name when subsequently pasted back in. If you name a region that has multiple cues in it, ALL the cues will share the same name when you come to paste it back in.

You may also select the type of edit you wish to copy using F1 - TYPE? (or by moving the cursor specifically to the EDIT TYPE field). There are two choices you can make. WHOLE REGION selects that everything within the IN/OUT region to be copied:



Selecting ONLY WHOLE CUES will copy only the whole cues whose' start and end fall within the edit region:



Cues whose start and end fall outside the edit region will not be copied. When ONLY WHOLE CUES is selected, the selected cues will be highlighted ochre on the external monitor.

NOTE: The selection made in this field is retained when you leave the page. When you subsequently re-enter the COPY page, the selection you made previously will be shown.

SINGLE-MACHINE EDITING

CUT TO CLIPBOARD

CUT is similar to COPY except that, as well as copying the edit region/cue(s) to a clipboard, it also removes the audio from the GRID and closes the gap thus created, shifting all audio after the edit accordingly. For example:

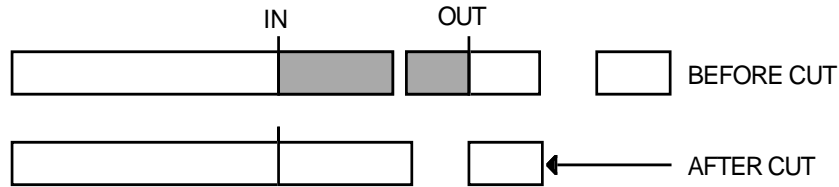

Pressing CUT (F2) from SINGLE-MACHINE EDIT will display this screen:

```

CUT TO CLIPBOARD
  CUT length : 00:00:03:12.8
  To clipboard : 0
  Clipboard name : CLIP 0
  Slip type : SLIP WHOLE TRACK
Slip?
  
```

The length of the edit region/cue(s) is shown in the CUT LENGTH field. The EXECUTE key's LED will flash and if you press EXECUTE at this point, the selected edit region/cue(s) will be cut into the default clipboard 0. As with COPY, you may also cut an edit into the edit clipboard 1-9 using the numeric keypad simply by pressing a number key as appropriate before pressing EXECUTE. You may also name the edit prior to cutting it to the clipboard by typing a suitable ten character name on a PS/2 keyboard connected to the RE32. Press RETURN to complete the naming process and RETURN again to complete the CUT.

NOTE: As the process is identical, please refer to COPY TO CLIPBOARD for a detailed description of naming a clipboard.

F1 - **SLIP?** - allows you to decide how subsequent audio will slip. Pressing this key will toggle between SLIP WHOLE TRACK and SLIP ONLY CUE in the SLIP TYPE field. The effect is:

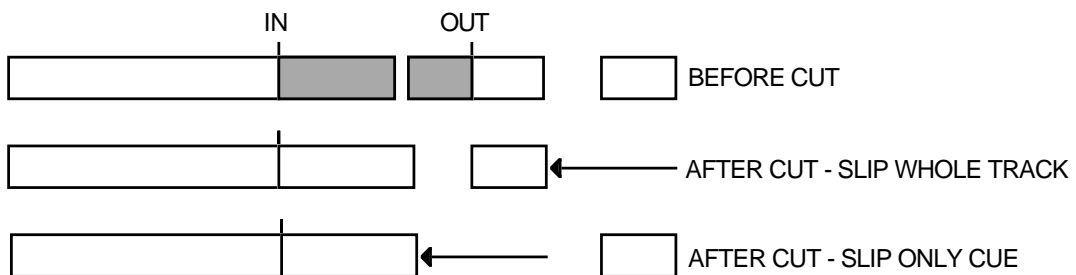

With SLIP whole track, everything after the CUT slips to accommodate the edit whereas with SLIP ONLY CUE selected, only the current cue is slipped. In this way, you can create cuts without affecting subsequent cues which will remain unaffected.

NOTE: The selection made here is retained when you leave the page. When you subsequently re-enter the CUT page, the selection you made previously will be shown.

CUT FORWARDS TO CLIPBOARD (SHIFT+CUT)

Pressing SHIFT + CUT (F2) from SINGLE-MACHINE EDIT allows the opposite of CUT in that it removes the selected edit region or cue(s) but slips all audio *before* the edit in time accordingly:

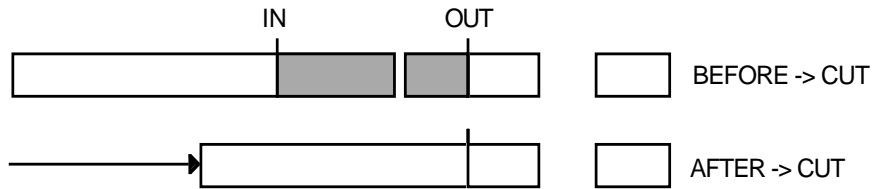

This type of cut may be used when you need to get rid of something but all audio after the cut point is perfectly synced. As with CUT, you may cut the edit region/cue(s) to a clipboard. Pressing SHIFT + CUT (F2) from SINGLE-MACHINE EDIT will display this screen:



The length you are about to cut is shown in the CUT LENGTH field. You may cut the edit region/cue(s) and place it in the default edit clipboard 0 simply by pressing EXECUTE at this point. You may wish to cut it and place it in one of the clipboards 1-9.

You may also name the edit prior to cutting it to the clipboard by typing a suitable ten character name on a PS/2 keyboard connected to the RE32. Press RETURN to complete the naming process and RETURN again to complete the CUT.

NOTE: As the process is identical, please refer to COPY TO CLIPBOARD for a detailed description of naming a clipboard.

The **Slip?** key (F1) allows you to decide how material before the cut will be affected. With SLIP WHOLE TRACK selected, all material prior to the cut will skip to accommodate the edit. With SLIP ONLY CUE selected, only the cue you are working on will be affected. For example:

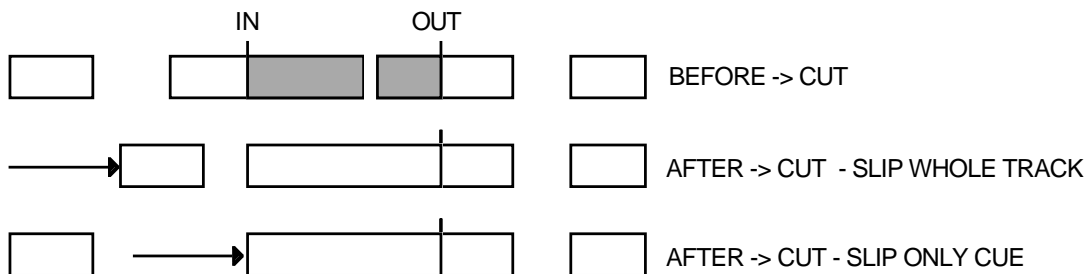

NOTE: The selection made here is retained when you leave the page. When you subsequently re-enter the >CUT page, the same selection as you made previously will be shown.

ERASE TO CLIPBOARD

ERASE is similar to CUT except that it will remove the currently selected edit region/cue(s) but will keep the gap thus created.

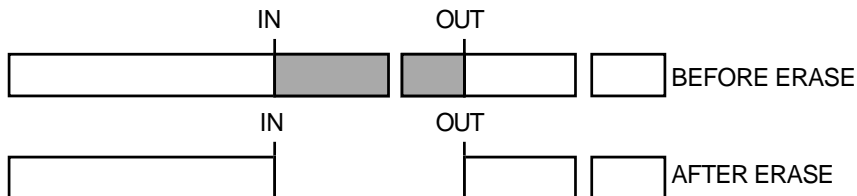

Pressing ERASE (F3) from SINGLE-MACHINE EDIT will give you this screen:

```

ERASE TO CLIPBOARD
ERASE length : 00:00:03:12.8
To clipboard : 0
Clipboard name : CLIP 0
Edit type : WHOLE REGION
Type?
    
```

As with the other screens we have seen so far, the length you are about to erase is shown. When you press EXECUTE now, the selected edit region/cue(s) will be erased and placed in default clipboard 0 and given the default name Clip 0. If you wish, you may erase the edit region/cue(s) and place it in one of the clipboards 1-9. You may also name it prior to erasing it by entering a suitable ten character name from a PS/2 keyboard connected to the RE32.

You may also select the type of edit you wish to erase using F1 - TYPE?. There are two choices you can make. WHOLE REGION selects that everything within the IN/OUT region will be erased:



Selecting ONLY WHOLE CUES will erase only the whole cues whose' start and end fall within the edit region:



Cues whose start and end fall outside the edit region will not be erased. When ONLY WHOLE CUES is selected, the selected cues will be highlighted ochre on the external monitor.

NOTE: The selection made here is retained when you leave the page. When you subsequently re-enter the ERASE page, the same selection as you made previously will be shown.

DISCARD

The DISCARD function will discard material either side of the IN/OUT area but will not slip any subsequent audio.

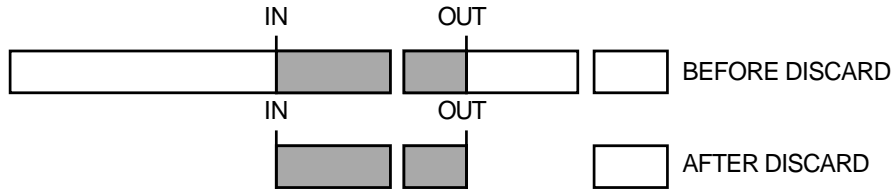

The DISCARD function is accessed from the second group of edit functions shown when the MORE (F6) key is pressed on the main edit page. Pressing MORE (F6) followed by DISCARD (F2) from SINGLE-MACHINE EDIT will give you this screen:

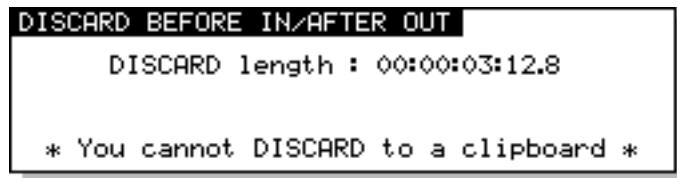

Pressing EXECUTE will complete the action.

The main use for DISCARD is to get rid of any rubbish in a cue before a certain point and after a certain point. For example, you may have a sound effect of a door slam which you recorded especially and, either side of the effect is talking, background noise and other such noises. To get rid of this, mark the start and end of the door slam and press DISCARD (SHIFT+ERASE) - this will keep the slam and remove the unwanted material either side of the IN/OUT marks.

Because this function's primary use is purely to clear out unwanted 'handles', you cannot discard the material either side of the IN/OUT marks to a clipboard or a library. If, for some reason, you really want to keep this material for later, you should mark these regions specifically and use ERASE and place them in a clipboard or library.

SINGLE-MACHINE EDITING

So far we have seen how to copy and remove audio from the GRID. Now let's have a look at how to put material into the GRID.

PASTE FROM CLIPBOARD

This will paste an edit *over* any material at the current NOW time. You will note that any gaps in the material being pasted will be pasted over any material that exists at the paste point. For example:

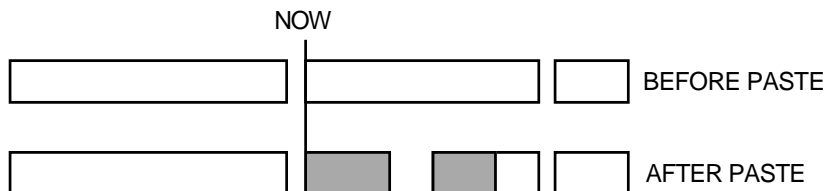

Pressing PASTE (F4) from SINGLE-MACHINE EDIT will give you this screen:



You can see the length of the audio you are about to paste. The default shown is that of the audio in clipboard 0. The EXECUTE key's LED will be flashing and should you press EXECUTE now, you will paste in clipboard 0 at the current NOW time (you will note that there is no need to have to mark an IN or OUT time when pasting - the edit is simply pasted in on the selected track(s) at the current NOW time). If you select another clipboard 1-9 (using the numeric keypad), the length field will change to reflect the material in the selected clipboard. Pressing EXECUTE will paste from the selected clipboard.

If you want to audition the clipboard prior to pasting it in to make sure you have selected the correct one, press PLAY (F3/F4). You will note that there is a small delay in playing audio from the clipboard.

PASTING TO OUT AND SYNC REFERENCES

It is also possible to paste material in a variety of different ways. The default is to paste the IN point of the source material at the current NOW time. For example:

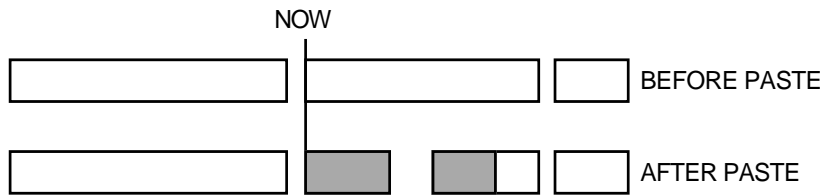

However, you may paste in material referenced to the source material's OUT point simply by pressing the OUT key prior to pasting. This will place the source material's OUT point on the NOW time pasting over preceding material. For example:

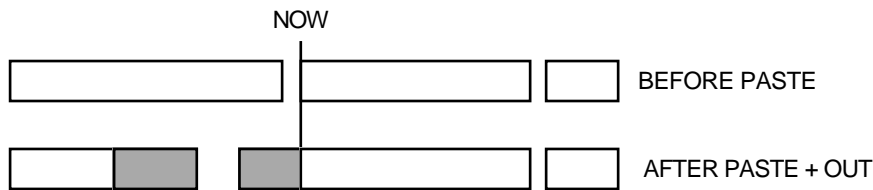

Known as 'back-timing', this is useful where you want a cue to end at a specific point but its start point is not so important. For example, you may want a piece of music to end at a certain point (maybe at the end of a scene). Locate to the end of the scene and jog over the exact point you want and then press PASTE, OUT, EXECUTE (to paste from default clipboard 0) or PASTE, OUT, 1-9, EXECUTE (to paste from the edit clipboard)¹. As you press the OUT key, so you will see the LCD's 'REFERENCED TO' field change to SOURCE OUT. If you wish, you may specifically move the cursor to this field and change it using the DATA ENTRY +/- keys.

It is also possible to paste material referenced to the source material's SYNC point. Assuming you marked a SYNC point in the source material, press PASTE, SYNC, EXECUTE. The following will occur:

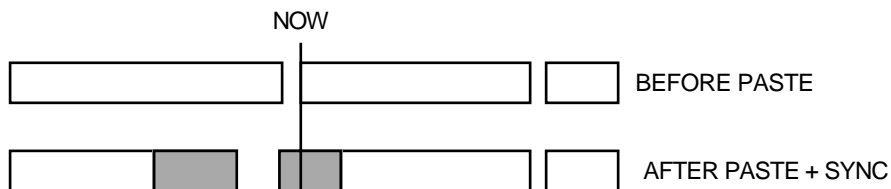

You may also paste and sync an edit from the clipboard - i.e. PASTE, SYNC, 8, EXECUTE to paste the sync point of clipboard 8 to the current NOW time .

This is similar to back-timing except that you can set the exact position you want synced, not just the end. You may use this, for example, to sync up a music crescendo with a dramatic point in the visuals or you may use this to back time the end of some music or dialogue or a sound effect (some passing traffic, perhaps) so that the very end of the cue maybe trails over into the next scene. Whatever. There are many uses for this which you will no doubt discover for yourself.

NOTE: If you try to paste referenced to a SYNC mark and there isn't one, it will paste referenced to the source material's IN point

¹ In fact, the actual order in which you press the keys is not that important. For example, you may press PASTE, 8, OUT, EXECUTE to paste the out time of clipboard 8 the current NOW time or you may press PASTE, OUT, 8, EXECUTE to achieve the same effect. Similarly, the order you press the clipboard and SYNC keys is not important.

SINGLE-MACHINE EDITING

INSERT FROM CLIPBOARD

This will insert an edit at the current NOW time and will cause any audio after the insert point to be shifted.

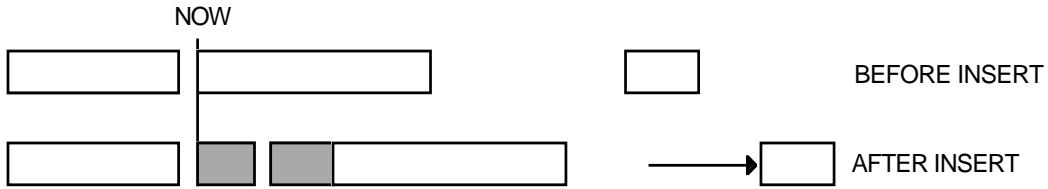

Pressing INSERT (F5) from SINGLE-MACHINE EDIT will give you this screen:



The default selection is to insert material from clipboard 0 but you may, of course, insert material from any of the clipboards 1-9 by selecting the appropriate number on the numeric keypad. The length of the insert will be shown in the INSERT LENGTH field. Press EXECUTE to complete the insert.

Prior to inserting the item from the clipboard, if you at all unsure what it is you are inserting, use PLAY CLIPBD to audition it.

You can use the **SLIP?** key to select whether the whole track will slip to accommodate the insert (SLIP WHOLE TRACK) or just the remainder of the cue at the point of insert (ONLY SLIP CUE) will slip. The result would be:

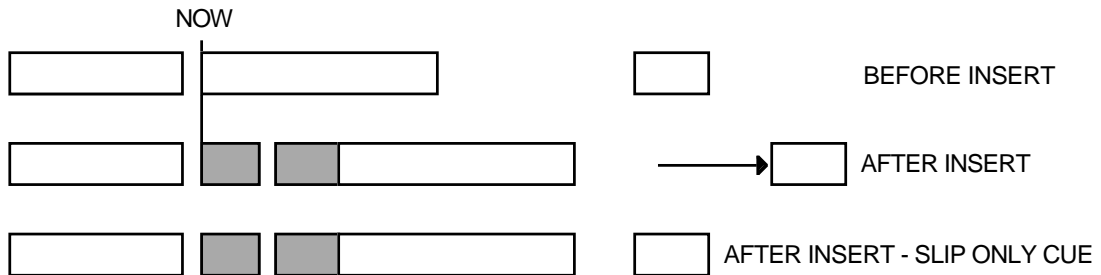

NOTE: The selection made here is retained when you leave the page. When you subsequently re-enter the INSERT page, the same selection as you made previously will be shown.

INSERTING TO OUT AND SYNC REFERENCES

As with PASTE and OVERLAY, you may also insert material referenced to the source material's OUT point by pressing INSERT, OUT, EXECUTE. The REFERENCED TO field in the LCD will show OUT and the effect would be as follows:

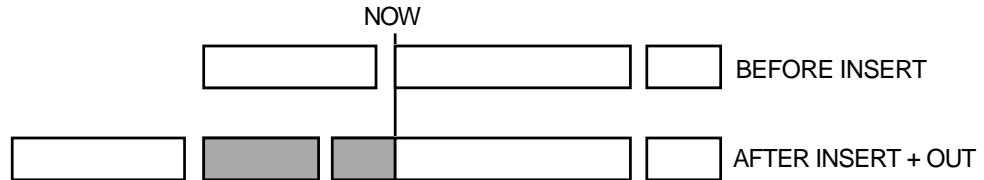

In this example, the inserted material all audio *before* the NOW time would slip allowing you to back-time the insert.

You may also insert referenced to the source material's SYNC mark. This is useful for bringing in material that needs to synchronise to specific visual events or to another piece of audio (a clichéd example would be to sync a music crescendo to a gun shot).

Pressing INSERT, SYNC, EXECUTE would give this result:

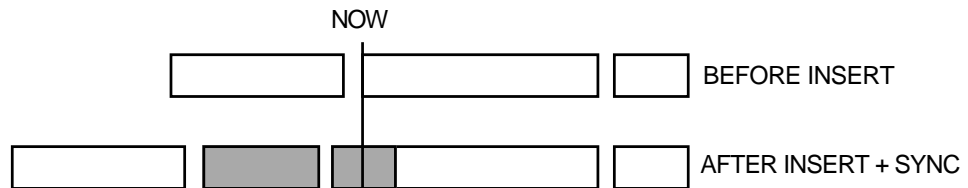

NOTE: *If you try to insert referenced to a SYNC mark and there isn't one, it will insert referenced to the source material's IN point*

In both examples, you may also use the clipboards 1-9. For example, INSERT, OUT, 6, EXECUTE would insert clipboard 6 referenced to its OUT point.

OVERLAY FROM CLIPBOARD

Overlay is similar to PASTE in that it pastes *over* any existing material at the point of pasting but, if there are any gaps in the material being pasted, these are 'transparent' and will reveal any audio 'underneath'. For example:



Compare this with PASTE where the gap in the pasted material 'obscures' the material beneath it.

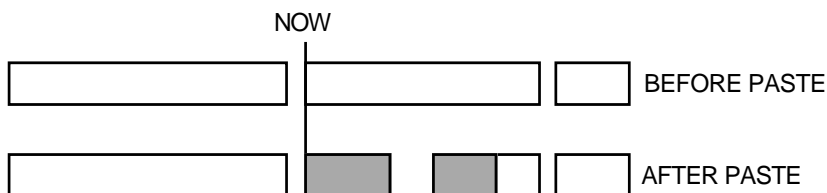

When using PASTE, the area 'underneath' the gap being pasted over would not be heard whereas with OVERLAY it would.

The OVERLAY function is accessed from the second group of edit functions shown when the MORE (F6) key is pressed on the main edit page. Pressing MORE (F6) followed by OVERLAY (F4) will display this screen:



As with paste, you may overlay material from the default clipboard 0 or from clipboards 1-9. EXECUTE completes the action and closes the screen. If you are not sure of the clipboard you have selected to OVERLAY, you can press PLAY to audition it prior to committing it.

OVERLAYING TO OUT AND SYNC REFERENCES

You may overlay referenced to the source material's SYNC or OUT points simply by pressing SYNC or OUT prior to pressing EXECUTE (see PASTING TO SYNC OR OUT REFERENCES for a detailed description of using the SYNC and OUT keys for back-timing as the function is essentially identical even if the end result is slightly different).

MOVE REGION

The MOVE function allows you to move a cue or an edit region to another track. This is faster and more convenient than using ERASE to remove the cue/region from one selected track, de-selecting that track and selecting the destination track and then pasting it back in.

The MOVE function is accessed from the second group of edit functions shown when the MORE (F6) key is pressed on the main SINGLE-MACHINE EDIT page. To move a cue/region from one track to another, select the source track using the TRACK EDIT keys and then select the cue or mark the region you want to move. Press MORE (F6) followed by MOVE (F1). You will see this screen:



Select the 'destination' track in the TO TRACK field and press EXECUTE to move the region. The cue/region on the track selected for editing will be moved from the 'source' track and will be placed at exactly the same time on the track specified in this field.

In the case of moving several tracks, the TO TRACK field sets the first track the lowest numbered track will move to - all other tracks selected for edit will be moved to adjacent tracks. For example, select tracks 6, 7, 8 for EDIT, press 1 of the numeric keypad to select 1 - tracks 6, 7, 8 will be moved to tracks 1, 2, 3.

IMPORTANT NOTE: Existing cues or overlapping cues on the destination tracks will be pasted over.

This function is only intended as a simple way to move audio from one track to another at the same time location. For more complex moves, you should use CUT/ERASE and PASTE/INSERT.

Pressing the BY AMOUNT soft key will take you to the MOVE REGION BY AMOUNT page which allows you to move a cue or region by a specified amount.

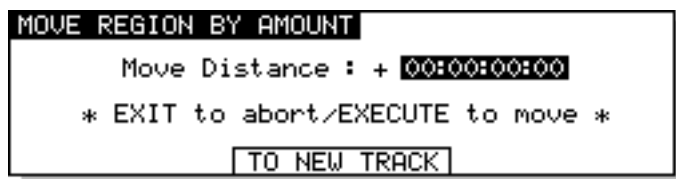

First select the source track using the TRACK EDIT keys and then select the cue or mark the region you want to move. Select the amount you wish to move the audio by in the MOVE DISTANCE field and press EXECUTE to move the region. The cue/region on the track selected for editing will be moved by the specified amount.

NUDGING IN/SYNC/OUT TIMES

This allows you to use the DATA ENTRY +/- keys to slip and nudge edits or audio into position. The NUDGE function is accessed from the second group of edit functions shown when the MORE (F6) key is pressed on the main SINGLE MACHINE EDIT page. Pressing MORE (F6) followed by NUDGE (F3) will display this screen:

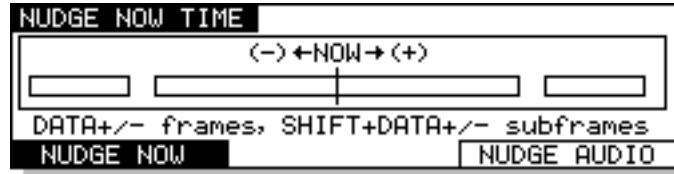

This is a graphic representation of what is happening when you nudge. This page allows you to nudge the NOW time into position prior to marking an IN, SYNC or OUT time. For example, if you cannot set an edit precisely using the JOG wheel, you can use this page to nudge the NOW time into position using the DATA ENTRY +/- keys which will nudge the NOW time, frame by frame, until it is at exactly the right position. Typically, you would use this by roughly jogging over an edit point using the JOG wheel, pressing NUDGE and use the + or - keys to nudge backwards or forwards in increments of frames, maybe use PLAY TO and/or FROM to audition the point and then mark an IN, SYNC or OUT point as appropriate.

You can also hold down the SHIFT key while pressing the DATA ENTRY +/- keys to nudge in increments of sub-frames (however, please see below - NUDGE SET - as you can set the increments by which the NOW time will be nudged).

You may also use NUDGE with SELECT Q to set the SYNC point at which you mark the cue. Line up the cue you are interested in on the NOW time and press NUDGE. Now use the +/- keys to nudge the NOW time and, when you're happy with the position, press SELECT Q. The cue will be selected and the SYNC point will be marked on the NOW time you have just set.

NUDGING AUDIO

It is also possible to physically nudge and slip audio into position using the NUDGE function. Pressing F5/F6 gives this screen:

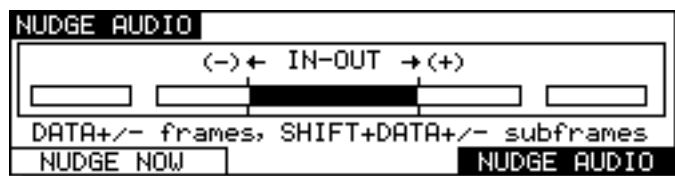

To nudge audio (that is, to physically slip it in time), you must first select an IN and OUT region. This may be done before or after entering NUDGE AUDIO. Assuming the appropriate tracks are selected for EDIT, this can be done in a number of ways...

To select a single cue for nudging, line the cue you wish to nudge onto the NOW time and press SELECT Q. The cue will be highlighted green on the external monitor. For stereo cues, select the tracks for edit as necessary.

To select a specific IN and OUT region to nudge, mark the IN and OUT points where necessary. The edit region will be highlighted green on the selected track. You may also select several tracks.

To select everything from the NOW time to the end of the track to nudge, press and hold the IN key and press OUT. Everything from the NOW time to the end of the track will be selected and highlighted green on the external monitor. You may do this across several tracks.

To select everything from the NOW time to the start of the track to nudge, press and hold the OUT key and press the IN key. Everything from the NOW time back to the start of the track will be selected and highlighted green on the external monitor. You may do this across several tracks.

To select the whole track to nudge, press and hold SYNC then press IN and OUT together. This will mark the whole of the selected track and it will be highlighted green on the external monitor. You may, of course, have multiple tracks selected for editing.

However you mark it, as soon as you press the DATA ENTRY + or - keys, the selected audio will slip forwards or backwards in increments of one frame or press +/- keys while holding the SHIFT key down to slip in smaller increments of sub-frames (however, please see below - NUDGE SET - as you can set the increments by which the audio will be nudged). If you are in the middle of a cue, as soon as you nudge it, the cue will be split and the audio slipped.

UNDOING A NUDGE

You cannot undo a nudge directly within the NUDGE pages but, when you leave the page, if you feel the result was unsuccessful, you may undo it. When in the NUDGE page, if you feel an edit is not working well, leave NUDGE temporarily, hit UNDO and re-enter NUDGE to have another attempt.

NUDGE SET (SHIFT+NUDGE)

The NUDGE key's shift function, SET, allows you to set by how much the +/- keys will nudge. Pressing SHIFT+NUDGE (F3) will display this screen:



The fields on this page are:

DATA +/- KEYS Here you may set the amount the DATA +/- keys will nudge. The usual selection (and hence the default) is 1 frame. You may select from 1-25 frames (or 24 or 30 depending on the frame rate of the timecode type you are using).

SHIFT+DATA +/- KEYS This field allows you to set the amount by which the DATA +/- keys will nudge when the SHIFT key is held at the same time. The default is 1 sub-frame and you may select from 1-9 sub-frames.

Pressing EXIT will leave this screen at any time.

SPLIT CUE

As its name suggests, SPLIT will split a cue in two. Although this can be done in other ways (NUDGE, IN->NOW, CUT, ERASE, etc.), these all involve either removing audio or moving it. SPLIT just splits the cue in two, making two cues out of one. Each cue may then be edited separately. I.e.:

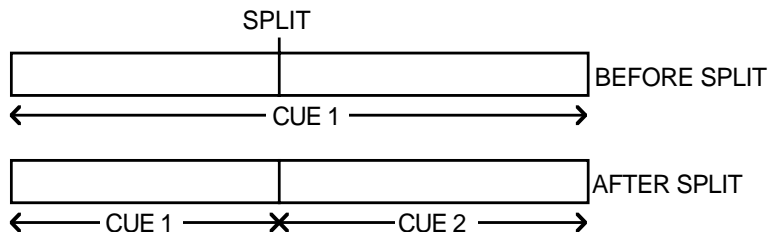

The process can be repeated almost indefinitely within one cue, splitting it up into smaller sections each time. EXECUTE is not required for SPLIT CUE.

The SPLIT function is accessed from the second group of edit functions shown when the MORE (F6) key is pressed on the main edit page. Pressing MORE (F6) followed by SPLIT (F5) from SINGLE-MACHINE EDIT will execute a SPLIT.

You may find this function useful in many ways. You may like to chop up individual sentences and phrases in a dialogue recording or split a music cue into smaller sections.

You may use it to create a cue within a longer cue. For example, you may wish to 'duck' a section of a long music cue so as not to overpower a bit of dialogue or a specific sound effect. Firstly, go to the start of the section in CUE 1 you wish to 'duck' and press SPLIT. This will create CUE 2. Now find the end of the section you wish to 'duck' and press SPLIT again - this will create CUE 3. You will end up with this:

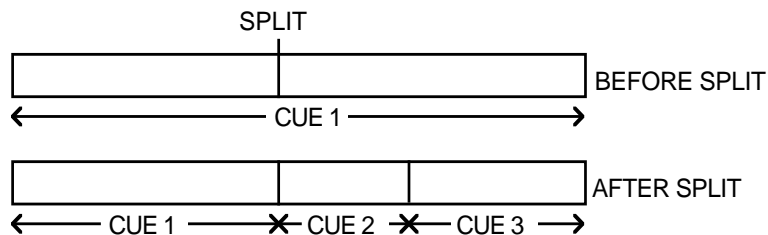

Now jog back into CUE 2 (or hold down GOTO and press the DATA ENTRY '-' key to go to the previous cue) and press SELECT Q, followed by EDIT Q - you may now edit CUE 2's level parameter, bringing it down by a few dB's.

(See EDIT CUE section for details about setting cue levels)

Three other edit related features are available as SHIFT functions on the IN, SYNC and OUT keys.

IN->NOW (SHIFT+IN)

The IN key's shift function, IN->NOW, allows you to slip audio by moving the marked edit region/ cue(s) time to the current NOW time.

For example, to move a piece of audio to a new position, mark an edit region as appropriate, play, jog, locate or whatever to the point you want it and press IN->NOW. The edit region's IN point will be repositioned at the current NOW time. I.e.:

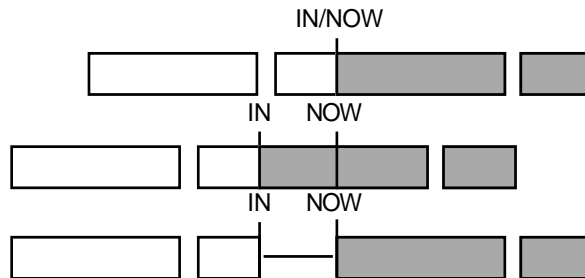

In this way, you may move a piece of audio into sync. Let's take a practical example. Imagine you are working with the system connected to a VTR using RS422. You have pasted or inserted a few dog bark sound effects but one of them is slightly early and out of sync with the picture. Firstly, mark an IN at the start of the out-of-sync dog bark and then mark an OUT at the end of it (or line up the dog bark on the NOW time and press SELECT Q). For example:



Now, jog the video forward from the RE32's jog wheel (ignore the audio for the moment) until you see where the dog's mouth is just beginning to open. Jog back and forth until you get an exact sync point and press IN->NOW (SHIFT+IN) followed by EXECUTE. The offending dog bark will be moved forward and re-positioned at the exact point where the mouth opens. I.e.:



Of course, it may be that you need to slip the entire track in this way. To achieve this, press IN and then, whilst holding the IN key, press OUT - this will select the whole of the track from the IN time onwards and will slip it backwards or forwards accordingly.

If you wish to slip only a cue, use SELECT Q. This will mark the IN and OUT at the start and end of the selected cue and IN->NOW will slip the cue accordingly.

Pressing IN->NOW gives this screen:

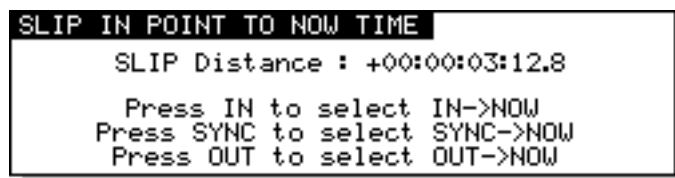

You can see how much you have moved the IN time in the SLIP DISTANCE field. If you move forwards (i.e. jog clockwise, fast forward, play), a '+' appears before the SLIP DISTANCE field; if you move backwards (i.e. jog counter clockwise, rewind or play reverse), a '-' sign appears. As you jog or play or rewind with this page open, you will see this time field changing. Press EXECUTE to complete the action.

SINGLE-MACHINE EDITING

Of course, you may not always want to slip the IN time to the NOW position - you may wish to move an edit region's/cue's SYNC marker or OUT point to the NOW time.

As the screen informs you, these are selected using the SYNC and OUT keys. Pressing SYNC displays this screen:

```

SLIP SYNC POINT TO NOW TIME
SLIP Distance : +00:00:03:12.8
Press IN to select IN->NOW
Press SYNC to select SYNC->NOW
Press OUT to select OUT->NOW
    
```

The effect of this would be as follows:

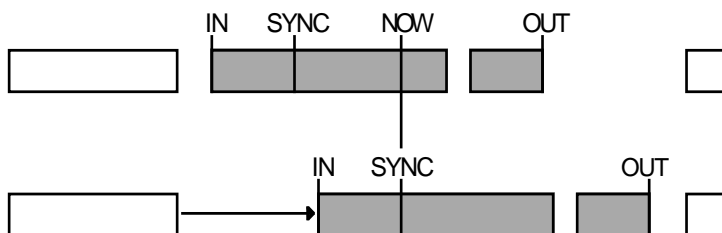

The SYNC point is moved to the NOW time. Of course, if you were to have pressed SYNC and then OUT together, you would have selected the whole track from the SYNC point to the end and the whole track would be slipped accordingly. You could also press SYNC plus IN and OUT together to slip the whole track from start to finish referenced to the SYNC point. In the above example, however, we have marked a specific edit region to slip.

You may use SELECT Q to good effect in this case. Because the action of selecting a cue marks a SYNC mark at the point you press SELECT Q, line up the cue at the point you want to sync and press SELECT Q. The cue will be selected and the SYNC will be marked. Now use SYNC TO NOW followed by EXECUTE.

You may also need to slip the edit region's/cue's OUT time to the NOW time. Pressing OUT displays this screen:

```

SLIP OUT POINT TO NOW TIME
SLIP Distance : +00:00:03:12.8
Press IN to select IN->NOW
Press SYNC to select SYNC->NOW
Press OUT to select OUT->NOW
    
```

The effect of this using the above example would be as follows:

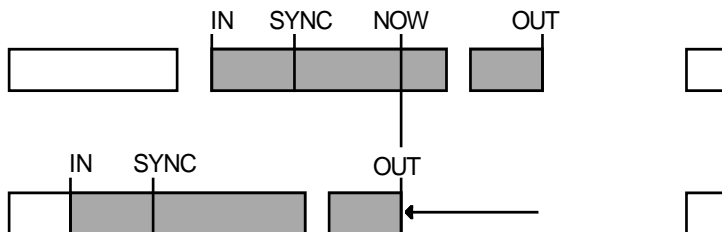

Here, the OUT point has slipped backwards to the NOW time when you press EXECUTE. However, this function could be used to slip a cue forwards, slipping the cue's OUT point to the NOW time. By pressing OUT and holding it while you press IN, you may slip a track from its start to the selected OUT time backwards and forwards.

To revert to slipping the IN time to the NOW time after selecting SYNC to NOW or OUT to NOW, press the IN key.

NOTE: *The IN->NOW (and SYNC and OUT->NOW) can paste over material (as in the above example of OUT->NOW). Please be careful not to accidentally lose data this way. If you make a mistake, you can use UNDO to repair it.*

Of course, you can also use the NUDGE function to move and slip audio around but the IN->NOW offers a more tactile and 'physical' way of syncing audio to picture that nudging (whilst also useful) does not always offer.

EDIT PLAY KEYS

The special play keys above the main transport keys are normally used when editing to check the location of edit points. Typical operation is to jog over an edit point and use PLAY TO or PLAY FROM to audition them quickly.

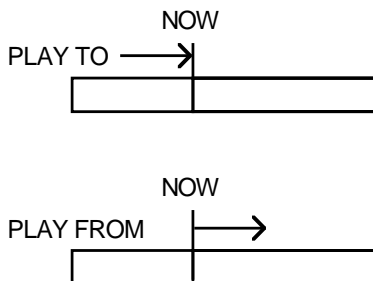

Playback response time of these keys is extremely fast allowing rapid auditioning. Once you are happy that you are at the right point, you can mark an IN, SYNC or OUT time as appropriate. Of course, you may mark the IN, SYNC or OUT and then use these edit play keys, maybe nudging the NOW time, auditioning and re-marking the point.

The default PLAY TO time is 1 second but, if you need longer times, you may change this by pressing SHIFT+PREROLL to go to the PREROLL SETUP page and then PLAY TIMES (F1/F2) to go to this screen:

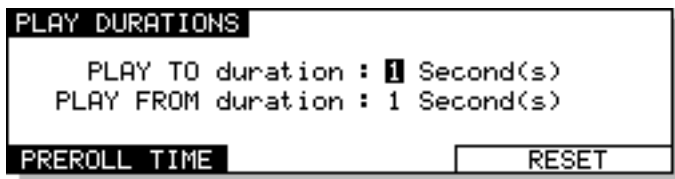

Here, you may set the play duration for the PLAY TO and PLAY FROM keys. You may reset the play durations at any time by pressing RESET (F5/F6).

Once an edit region has been marked or a cue has been selected, you may use the PLAY IN > OUT key to listen to the edit region:

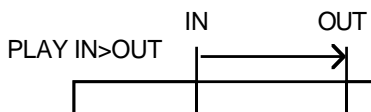

SELECT CUE/EDIT CUE

EDIT CUE allows you to edit a cue's level and fade up and fade down parameters. Typical operation is to move the cue you are interested in onto the NOW time, select the appropriate track for editing and press the SELECT Q key. This will select that cue for editing, marking an IN at the start of it, OUT at the end of it and a SYNC mark at the current NOW time. You can then enter the EDIT CUE page to set that cue's level and fade parameters. When you press the EDIT Q key, the selected cue will be shown ochre on the external monitor. E.g.:

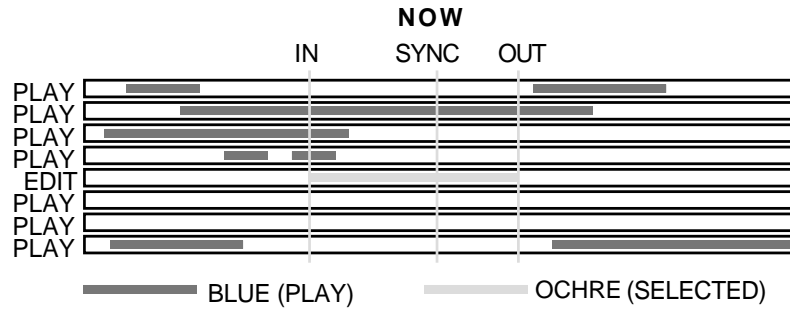

You may also select 'stereo' cues in the same way by selecting two tracks for editing. E.g.:

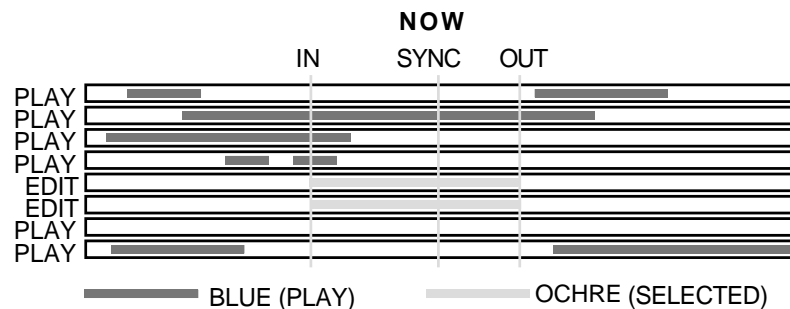

When you press the EDIT Q key, the selected cues will be highlighted in ochre.

It is also possible to select non-related multiple cues across several tracks if you wish. In this way, you can set levels and fades for many cues in one action. This is explained a bit later in this sections.

Pressing the EDIT Q key will display this screen:

```

EDIT CUE  Cues : 2/Len : 00:00:06:4
          Name : Dial 27
          Level : -15.6dB
          Fade Up : 00:00:06.10  Curve : LINEAR
          Fade Dn : 00:00:02:00  Curve : LINEAR
          INFO                               FADE | RESET
    
```

The parameters are:

- CUES This field is not accessible and it shows the number of cues currently selected.

- LENGTH This field is also not accessible and shows the entire length of the cue(s) selected or the length of the edit region.

SINGLE-MACHINE EDITING

NAME	<p>This field shows the name of the currently selected cue(s). It also allows you to rename the cue(s). To do this, move the cursor to this field and enter a ten character name from a PS/2 keyboard connected to the RE32. Press RETURN to complete the name and RETURN again to rename it.</p> <p>If only one track is selected for edit, you will, of course, only rename that one cue. If more than one track is selected (for example, when editing a stereo cue across two tracks), the name of the cue on the lowest numbered track will be shown. Naming stereo or multiple cues will cause all the cues selected to share the same name.</p>
LEVEL	<p>You may set the level of the cue(s) in this field. You may, input data numerically from the keypad or using the DATA +/- keys if the level adjustment you require is particularly fine (i.e. -3.5dB). To do this, move the cursor the LEVEL field and type in a number as appropriate.</p> <p>If several cues are selected, this parameter allows you to set the level for all cues. You will note, however, that, as with all EDIT CUE parameters, as soon as you edit the level here, ALL cues will be set to the same level. If you need to adjust levels of cues relative to each other, each cue should be edited separately.</p>
FADE UP	<p>Here you may set a fade up time for the cue. When a fade up time is set, it will be displayed on in the cue's block display on the monitor screen (if selected in the SHOW ON VGA pages). The fade up time can only be as long as the cue itself or the length of the cue minus any fade down that may have been set.</p> <p>If stereo or multiple cues are selected, you can set the fade up for all of them simultaneously.</p>
CURVE	<p>This selects the fade up curve and you have a choice of three.</p> <p>LINEAR (/) - This selects a straight, linear fade curve.</p> <p>LOG () - This selects a logarithmic curve as shown.</p> <p>SINE () - This selects an equal power fade curve that ensures an even level across crossfades.</p>
FADE DN	<p>Here you may set a cue's fade down time. When a fade down is set, it is shown graphically on the monitor screen (if selected in the SHOW ON VGA pages). The fade down time can only be as long as the cue itself or the length of the cue minus a fade up time that may have been set.</p>
CURVE	<p>As for FADE UP.</p>

Pressing INFO (F1) from the EDIT CUE screen gives the following information about the selected cue(s):

```
CUE INFORMATION
Original Time : 10:15:12:10:12
Length : 00:00:27:43:32
Number of Cues : 2
```

Pressing FADE (F5) from the EDIT CUE screen gives you this screen:

```
EDIT CUE Cues : 2/Len : 00:00:06:4
Name : Dial 27
Level : -15.6dB
Fade Up : 00:00:06.10 Curve : LINEAR
Fade Dn : 00:00:02:00 Curve : LINEAR
Set fade: START TO NOW NOW TO END
```

START TO NOW (F3/4) executes a fade up from the beginning of the cue to the NOW time.

NOW TO END (F5/6) executes a fade down to the end of the cue, starting at the NOW time.

Pressing RESET (F6) from the EDIT CUE screen gives you the option of resetting the EDIT CUE parameters to zero - i.e. level to 0.0dB and fades to 00:00:00:00.0. This may be useful if you change your mind about some settings you have made and wish to start again.

You may also UNDO your efforts in EDIT CUE. You cannot undo anything whilst actually in EDIT CUE but, as soon as you leave EDIT CUE, you can restore the parameters to the state they were in when you entered it.

SINGLE-MACHINE EDITING

USING EDIT CUE TO AFFECT MULTIPLE CUES

You can also set the level and fade parameters for groups of cues by marking an IN and OUT time (or using SELECT Q). This will select all cues within the IN/OUT region thus:

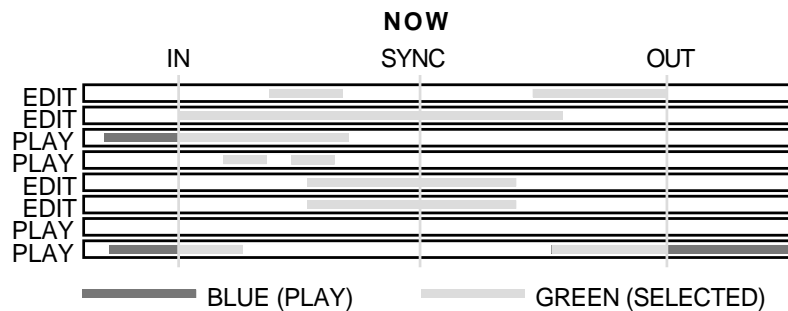

Pressing EDIT Q will select only those cues whose start and end points fall within the edit region will be selected (highlighted ochre). Those cues whose start and end do not fall within the edit region will not be selected. For example, pressing EDIT Q in the above example would show this:

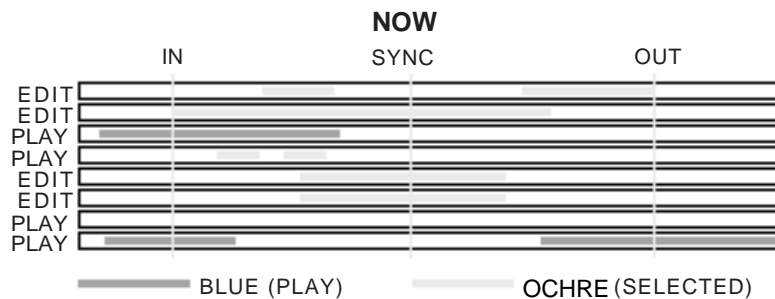

When several cues are selected for editing in this way, all cues take as their parameters those you have set in the EDIT CUE page and all the cues selected will be set to the same value(s).

However, whilst this can be useful in some cases (for example, setting the fade down and level parameters of a group of footstep sound effects so that they are all identical), it could potentially cause problems in other cases because you may accidentally reset parameters you have previously set on some cues! The RESET function won't help in this case as this will simply reset ALL cues' parameters to their default value of 00. Please be aware of this. In the event of a mistake, you can always use UNDO, of course.

EDIT CUE is really designed to set level and fade for single or stereo cues and for re-naming cues. The multiple cue editing is included as a convenience for those times when you wish to set parameters to a group of the same or similar cues.

As mentioned, typical operation would be to line up the mono or stereo cue(s) you want to edit on to the NOW time, select the track(s) as appropriate, press SELECT Q and then EDIT Q and set the level, fade up and fade down parameters as necessary. Then press GOTO +/- to select the next or previous cue, hit SELECT Q again and repeat the process if necessary.

CROSSFADE TOOLS

The crossfade tools allow you to modify a cue's start and end point to create a crossfaded overlap or to remove the gap between two cues and butt them together.

While in the CROSSFADE TOOLS page, the width of the tracks is halved on the display in order to clearly show overlaps of cues sharing the same track:

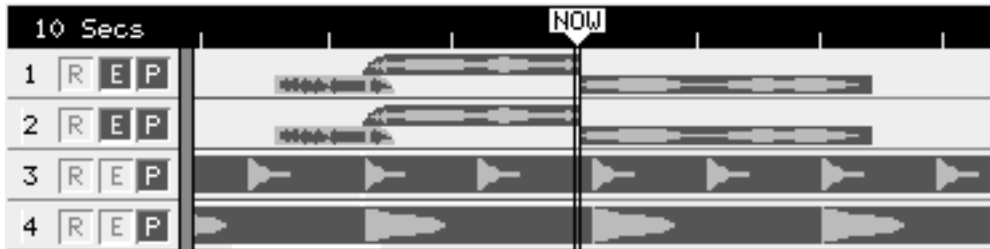

All the CROSSFADE TOOLS can be applied to a single track or across multiple tracks limited, in the case of cross fades, by the amount of audio buffer RAM you have fitted in each machine. Where appropriate, therefore, the term 'cue' can also be read as 'cues'.

The standard transport controls are disabled while in the CROSSFADE TOOLS pages.

Pressing the XFADE key (SHIFT+EDIT Q) takes you to main CROSSFADE TOOLS page where you have access to each of the 'Quick Tool' options - XFADE, BUTT, FADES - as shown below:

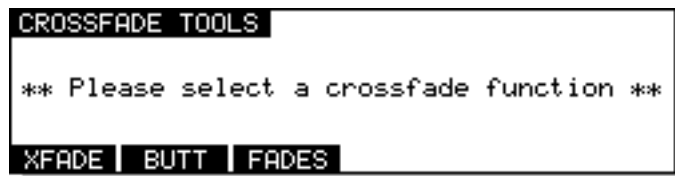

EDIT TOOLS

Pressing XFADE (F1) on the CROSSFADE TOOLS page takes you to this screen:



The parameters are:

AMOUNT

The amount by which the two cues are to overlap.

METHOD

The method by which the overlap is to be achieved (TRIM or SLIP) and may be selected either using the DATA ENTRY +/- keys or more directly using F1 and F2.

When TRIM is selected, one or both of the cues will be extended; this assumes that the cue in question has a handle available for extension. Note that the targeted cue turns yellow, while the passive cue stays green.

With SLIP selected, either the PRE or the POST cue (not BOTH) is actually moved along the timeline. SLIP IN can also be selected from within the TRIM page by pressing the IN key while pressing SHIFT. Similarly, OUT + SHIFT selects SLIP OUT.

SLIP mode is clearly dangerous if working to picture, hence the cues in question turn red in warning. Note that, when SLIP is selected F3 becomes active as SLIP? and toggles between slipping just the cue or the entire track:



ADJUST

Selects which point(s) is to be adjusted:

PRE (F4) Selects the PRE point for adjustment.

POST (F5) Selects the POST point for adjustment.

BOTH (F6) Selects both PRE and POST points for adjustment.

Having set the required parameters, press the EXECUTE key to proceed.

Pressing BUTT (F2) on the main CROSSFADE TOOLS page gives you this screen:

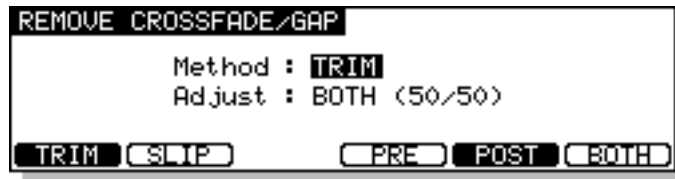

METHOD

Selects the method by which the BUTT is to be achieved .

With TRIM selected, one or both of the cues will be extended; this assumes that the cue in question has a handle available for extension. Note that the targeted cue turns yellow, while the passive cue stays green.

SLIP (F2) selects SLIP as the method, which means that either the PRE or the POST cue (not BOTH) is actually moved along the timeline. SLIP IN can also be selected from within the TRIM page by pressing the IN key while pressing SHIFT. Similarly, OUT + SHIFT selects SLIP OUT. SLIP mode is clearly dangerous if working to picture, hence the cues in question turn red in warning. Note that, when SLIP is selected F3 becomes active as SLIP? and toggles between slipping just the cue or the entire track.

ADJUST

Selects which point(s) is to be adjusted:

PRE (F4) Selects the PRE point for adjustment.

POST (F5) Selects the POST point for adjustment.

BOTH (F6) Selects both PRE and POST points for adjustment.

Having set the required parameters, press the EXECUTE key to proceed.

Pressing FADES (F3) on the main CROSSFADE TOOLS page takes you to the MODIFY FADES screen in which you have individual adjustment of the PRE and POST fade characteristics:

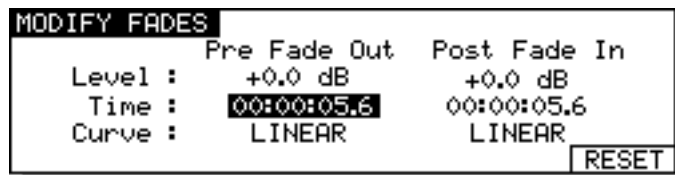

The parameters on this page are:

- LEVEL Adjusts the overall level of the selected cue
- TIME Determines the length of the fade.
- CURVE Sets the curve characteristic.

DISK MANAGEMENT

Now that we have some material recorded and edited, it's time to look at the utilities provided for managing disks connected to machines in the system.

All DISK functions are accessed using the DISK key. Pressing the DISK key will take you to this screen:



This screen is used for loading new projects and displays a list of the projects available on the selected disk. However, before looking at this in more detail, we should save the current project containing the material we have recorded and edited!

SAVING PROJECTS

Pressing SAVE (F1) displays this screen:



The page shows the name of the currently loaded project. Just press the flashing EXECUTE key to save (or EXIT to abort). This will save the project and leave the page. You will receive the following pop-up prompt when you leave the page after the file has been saved:



This message will flash up very quickly to confirm the project is saved.

NOTE: No "ARE YOU SURE?" prompts are given as it is felt that a quick way to save projects is very important. However, please be careful not to accidentally save something you do not wish to keep!!

If, at any time, you change your mind and do not wish to save the project, press EXIT to leave the SAVE page.

The parameters on the SAVE PROJECT page have the following functions:

TRACKS

When several machines are connected to the RE32 to expand the total number of tracks available, the system will behave as if there is a single 'multi-track' project containing all of these tracks. However, in reality each connected machine maintains its own internal project containing data for the tracks assigned to that machine.

When MULTI is selected in this field, the RE32 will tell each connected machine to save its local project. In other words, the system's 'multi-track' project is saved in its entirety.

You can also choose to save the project on a specific machine. To avoid confusion, the machines are listed by the tracks they represent. For example, machine 1 will be shown as "1-16", machine 2 as "17-32" etc..

DISK

This shows the disk ID to which the project will be saved on the selected machine.

NOTE: It is not possible to save the project to another disk and the DISK field is shown for information only. The system always saves the project back to the disk it was loaded from. This is because saving a project to another disk would detach the project from the audio. Imagine the situation where you load a project from hard disk on SCSI ID#0 and save it to an MO on SCSI ID#1. When you remove the MO and try to play it elsewhere, because the audio is not on that disk, the project would not play.

If you really want to have the project on another disk with its associated audio, you should copy the project using the DISK COPY functions.

AUTOSAVE

With AUTOSAVE switched OFF, you must specifically save projects when you feel it is appropriate. With AUTOSAVE switched to ON, whenever you do anything, the project is saved (saving is very fast - you won't notice any deterioration in speed or performance). After you record, cut, paste, erase, slip, undo, whatever, the project is saved automatically. As well as alleviating the need for a manual save, it has the added advantage that should anything go wrong, the project is safe.

Basically, there are pros and cons to the AUTOSAVE function - some users like not to worry about having to save and are happy for their every action to be saved immediately, others prefer to save manually as and when they like. You have the choice!

When AUTOSAVE is switched ON, this is shown on the VGA monitor to the top right of the GRID:

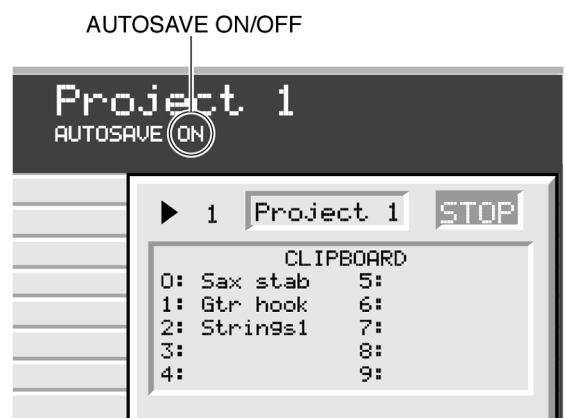

NOTE: On the DD8 or DR16pro, AUTOSAVE is always switched ON by default after power-up. On the DD1500, the AUTOSAVE setting is recalled from flash-ROM after power-up.

DISK MANAGEMENT

WRITE PROTECT	This parameter allows machines in the system to be write protected. When a machine is write protected, it is prevented from writing any new data to disk. This can be used to avoid accidentally destroying valuable data as when write protection is enabled, all record and editing functions are prohibited.
PROJECT NAME	This shows the name of the currently loaded project and is the name that will be used when saving it. You can select a new name as described in the next section, or automatically generate a new project name using the SAVE NEXT soft key (also described in the next section).

SAVING A PROJECT WITH A DIFFERENT NAME

To save a project with a different name simply enter a suitable ten character name from a PS/2 keyboard connected to the RE32. As you type, you will receive this screen:

```
SAVE PROJECT      Tracks:MULTI      Disk:4
      Autosave : ON
      Write Protect : OFF
      Project name : P1rSong
Enter name, then press EXECUTE
```

The PROJECT NAME field is automatically 'opened' for naming. The bottom line will prompt you to enter the name and complete the action by pressing EXECUTE (or RETURN on the external keyboard).

If the name has a number in it (i.e. PROJECT 1), you can save it with a new number just by pressing any of the number keys on the numeric keypad. For example, to save PROJECT 1 as PROJECT 2, simply press 2, EXECUTE, EXECUTE.

If the name you give the project already exists, you will receive this prompt:

```
File exists! Do you wish to overwrite??
```

You should press EXECUTE to overwrite the file or EXIT to cancel the process.

Pressing EXECUTE will save the project with the new name and you will leave this page.

You can also use the SAVE NEXT key to save the project with a unique name automatically generated. The basic name is retained and a unique number is appended to the end. Pressing SAVE NEXT will display this prompt:

```
SAVE PROJECT      Tracks:MULTI      Disk:4
      Save Project with unique name
      "PROJEC 34"?
EXIT to abort / EXECUTE to create file
```

Pressing EXECUTE saves the file with a unique numeric suffix and will return you to the screen you were in previously. EXIT will cancel the process. Please note, however, that the last four characters in the name are reserved for the auto-naming process to allow for up to 9,999 unique names. For example, if you were to use SAVE NEXT with a file called PROJECT 1, pressing F5/F6 - SAVE NEXT - would save the file as PROJEC 1. The next project you save would be called PROJEC 2, and so on.

SAVING LOCATOR MEMORIES OR OTHER SETTINGS

When a project is saved, if that project has locate memories associated with it, they will also be saved. A 'settings' file will also be saved automatically which will save the sample rate, timecode settings, etc., relevant to the project. The status of the track select keys (PLAY, RECORD, EDIT) will also be saved along with the status of keys such ON-LINE, CYCLE, PREROLL etc., allowing you to return to exactly the same state as you left the project when you saved it. If you have been making recordings in the project you are saving and have named recordings specifically, the last name you created will also be saved allowing you to return to the project and carry on recording where you left off.

DISK MANAGEMENT

Once you have a number of projects saved, it follows that you will want to load them again! You may also want to initialise the system in order to create a new project from scratch.

LOAD

Pressing DISK will give you this screen:



Here you can see a list of projects on the currently selected disk. As is the convention in file lists, if there are projects 'above' or 'below' the screen, an upwards and/or downwards pointing arrow will be shown (↑ / ↓). You may view and load projects on other disks by moving the cursor to the DISK field and selecting an external drive as appropriate.

To load a project, simply select the one you want and press the flashing EXECUTE key.

As the project is loaded you will see a status bar on the LCD showing you which tracks are being loaded:



When several machines are connected to the RE32 to expand the total number of tracks available, the system will behave as if there is a single 'multi-track' project containing all of these tracks. However, in reality each connected machine maintains its own internal project containing data for the tracks assigned to that machine.

When MULTI is selected in the TRACKS field, the RE32 will tell each connected machine to load its local project and you will see the status bar change as each individual machine's project is loaded on to the corresponding tracks.

In MULTI mode, the system assumes there is a project of the same name available on each machine on a disk at the same SCSI ID. If one of these individual project files cannot be found, you will receive a message indicating which tracks failed to load:

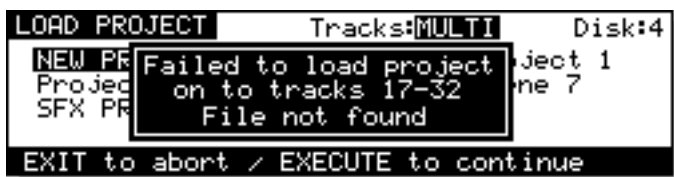

Pressing EXECUTE will skip the tracks on the machine that failed to load and continue loading tracks into the next machine in the system. Pressing EXIT will abort the process and return the system to its original state.

You can also choose to load a project on a specific machine. To do this, select the appropriate machine in the TRACKS field. To avoid confusion, the machines are listed by the tracks they represent. For example, machine 1 may be shown as "1-16", machine 2 as "17-32" etc..

As each machine is selected, the screen will update to show the list of local projects available on this machine. As before, to load a project, simply select the one you want and press the flashing EXECUTE key.

In either case, once the project has been loaded you will leave the load page. The following prompt will flash up on the screen to confirm the project is loaded:

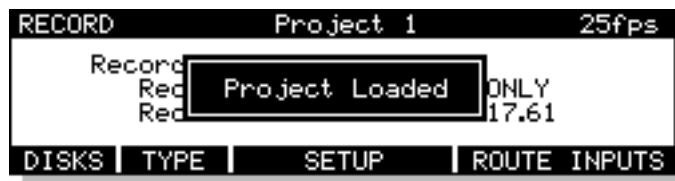

If you have been working on a project and have not saved it, if you request the system to load a project (or create a new one), you will now see the following prompt:



This is telling you that pressing EXECUTE will load the new project and any changes you may have made to the existing project will be lost. Press EXIT to abort the load so that you can save the current project before continuing.

If you have a project loaded but have not made any changes, if you try to load another or create a new project, this prompt will not appear.

Whenever you load a project, if that project has locate memories associated with it, they will also be loaded automatically. A 'settings' file will also be loaded automatically which will load the system sample rate, timecode settings, etc., relevant to the project. The status of the track select keys (PLAY, RECORD, EDIT) will also be recalled thereby returning you to exactly the same status as you left the project when you saved it.

NOTE: When you load a project and select tracks for playback, the cues will be shown blue on the external monitor. If, however, any are shown in a pale yellow colour, this indicates that, although a cue exists at that point in the project, the audio associated with it is not on any disk currently on-line.

This is not that likely to happen very often, however. An instance where it might occur is where you have recorded audio on to a disk separate from the project and then reloaded that project without all disks attached to the system.

CREATING A NEW PROJECT

Using NEW PROJECT, it is possible to create a new, empty project. After pressing DISK to enter the LOAD PROJECT page, selecting NEW (F2) will take you to the following page:

```
NEW PROJECT      Tracks:MULTI      Disk:4
Project name : PROJEC  2
Type : AKAI
```

As usual, you should press the flashing EXECUTE key to continue or EXIT to cancel. An empty project will be shown on the external monitor screen into which you may now start recording. The new project will be given a name automatically. You may rename this when you come to save it.

The TYPE field is used to select the type of project that will be created. The options available will depend on the format of the selected disk.

The options available are:

- | | |
|-------|--|
| AKAI | Create a new AKAI project on an Akai format disk |
| PT 4 | Create a new "Protools 4" Session on a Macintosh format disk |
| PT 24 | Create a new "Protools 24" Session on a Macintosh format disk. |

As with loading a project, if the current project has been edited and those changes have not been saved, you will receive the prompt if you try to create a new project:

```
NEW PROJECT      Tracks:MULTI      Disk:4
*** WARNING ***
Current project not saved!
Proceed without saving?
```

You should press EXECUTE to create the new project without saving the current one or EXIT to abort the process.

NOTES REGARDING CREATING A NEW PROJECT

Whenever you create a new project, the system's default SETTINGS file is loaded from flash ROM. This allows you to configure the system as you like so that starting work with a new project always loads the correct settings.

For example, you may always work at 44.1kHz starting at 10 hours. By zooming in to 8 tracks, setting the sample rate to 44.1kHz in the SETUP page and locating to 10:00:00:00.0 and saving the settings to flash ROM, this is how a new project will be initialised.

Furthermore, the status of keys such as the track select keys, the ON-LINE key, the PREROLL key, etc., is also saved and subsequently recalled when you create a new project.

Please see the section SAVING SETTINGS FILES for more information.

DISK UTILITIES

The DISK UTILITIES pages are where you do your disk management routines such as deleting unwanted files and unused audio, renaming files, etc.. You may also format disks, copy files from one disk to another and back up disks to tape.

Pressing the DISK key will show something like this display:



To access the DISK UTILITIES page, press DISK UTILS (F5/F6) and you will see this display:



As on other pages in the RE32, the TRACKS parameter is used to select the machine for which you want perform any of the DISK UTILITY functions. To avoid confusion, the machines are listed by the tracks they represent. For example, machine 1 may be shown as "1-16", machine 2 as "17-32" etc..

Once you have selected a machine, the DISK parameter is used to select the ID of the disk you want to access. As each disk is selected, the other fields on the page will update to show you the TOTAL CAPACITY of the selected disk as well as the amount of disk space used and the amount of remaining space for audio.

DISK INFO

Pressing INFO (F1) on the DISK UTILITIES page will display something like this screen:

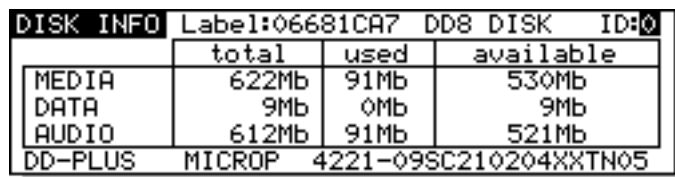

This screen gives more information about the type and size of the selected disk, how much of the disk is used and how much is free. These values are expressed in Megabytes.

This screen shows the type of disk currently in the selected drive. The LABEL field shows a hexadecimal number that is a unique number given to the disk at the time you format it. This number is used internally by the disk management system to make sure there are never any conflicts of disks when using multiple disks and also to allow any disk to be used in any drive at any time so that you do not have to worry about which drive you put a disk into. The number is generated randomly when you format the disk. It is highly unlikely that two of your disks will share the same label but this field is shown just in case you do experience some problem and you can compare labels to see if there is a conflict. However, the chances of this happening are remote to say the least! Part of the label is the name you gave the disk when you formatted. This is shown after the hexadecimal number.

The only field accessible in this page is the ID field in the top right hand corner. Here, you may select to view other disks that may be connected to this machine.

DISK MANAGEMENT

DISK DIRECTORY

The Directory page allows you to view all files on a selected disk. The default is to show Project files on the disks, but there are other files as well.

After selecting a machine and disk, pressing DIR (F2) on the DISK UTILITIES page will display something like this screen:

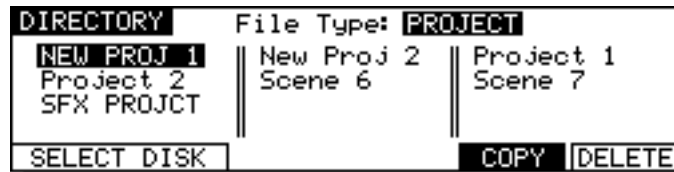

Here, you can see a list of the projects on the currently selected disk. There is only one field on this page on the very top line of the LCD:

FILE TYPE

Here you can select the type of file you wish to view, rename and/or delete. You may select PROJECTS, or LIBRARIES.

If there is a long filelist, arrows will appear to the right of the screen to indicate that there are files 'below' or 'above' the screen that you may access.

Pressing SELECT DISK (F1/F2) changes the screen to allow you to select a different disk or machine:

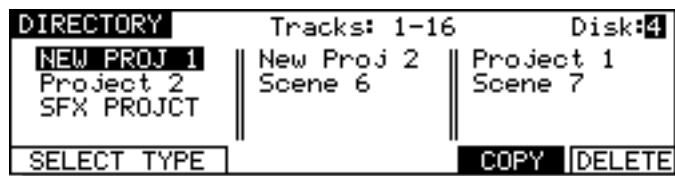

The parameters on the top line are:

TRACKS

Here you may select the machine that is connected to the disk drive you wish to look at and work on. To avoid confusion, the machines are listed by the tracks they represent. For example, machine 1 will be shown as "1-16", machine 2 as "17-32" etc..

DISK

Here you may select the disk drive you wish to look at and work on.

Files are selected by moving the cursor keys around the list and they are highlighted when selected.

Pressing DELETE (F6) allows you to delete the item selected by the cursor.

Pressing COPY (F5) allows you to copy items from one disk to another as described in the next section.

COPYING FILES/DISKS

It is possible to copy data from one disk to another. You may copy individual projects and libraries or copy the whole disk. Pressing COPY (F5) will give you this screen:



The parameters are:

TRACKS Here you may select the machine that is connected to the disks drive you wish to copy between. To avoid confusion, the machines are listed by the tracks they represent. For example, machine 1 will be shown as "1-16", machine 2 as "17-32" etc..

NOTE: Files can only be copied between two disks attached to the same machine.

DISK Here you may select the 'source' disk you are copying from.

TO DISK Here you may select the 'destination' or 'target' disk you are copying to.

COPY TYPE You may select the type of file you wish to copy in this field. You may select:

SINGLE FILE - this will copy a specific file as shown in the FILE TYPE and FILE NAME fields.

ALL PROJECTS - This will copy all projects on the source disk to the destination disk.

ALL LIBRARIES - This will copy all the libraries on the source disk to the destinations disk.

ALL FILES - This will copy all the files on the source disk to the destination disk.

DUPLICATE DISK - This will copy everything from the source disk to the destination disk.

IMPORTANT NOTE: DUPLICATE WILL FIRST ERASE THE DESTINATION DISK BEFORE DUPLICATING THE SOURCE DISK TO IT.

FILE TYPE When SINGLE FILE is selected, you may select the type of file you wish to copy (i.e. PROJECT, LIBRARY or SETTINGS) in this field.

FILE NAME This parameter allows you to select the file you wish to copy.

DISK MANAGEMENT

NOTE 1: When ALL PROJECTS or ALL LIBRARIES is selected in the COPY TYPE field, the FILE TYPE and FILE NAME fields are not shown:

```
COPY FILE          Tracks: 1-16   Disk:4
  To disk : 0
  Copy type : ALL PROJECTS
                                     COPY
```

NOTE 2: You cannot copy single CLIPS.

NOTE 3: It is not possible to copy from a disk to itself (i.e. from disk 0 to disk 0). You will receive the prompt: DISK CAN'T BE COPIED TO ITSELF!

Pressing F5/F6 initiates the COPY process. You will receive this prompt:

```
Copy disk 0 to disk 1?
```

The selected source and the target disks are shown. The EXECUTE key's LED will flash and you should respond accordingly, pressing EXECUTE to confirm or EXIT to cancel. During the copying process, the bottom line of the LCD will show something like this display:

```
Copying PROJECT 1..(Press EXIT to abort)
```

A highlighting display will move across the bottom of the LCD as the file is copied. The copying process is approximately 2-4 times faster than real-time (i.e. a 12 minute piece of audio will take between 6 and 3 minutes to copy). The time it takes to copy depends on the speed of the disks you are using (i.e. MO to MO is going to take longer than a hard disk to hard disk copy) and the nature of the files you are copying (e.g. one single 12 minute piece of audio is likely to get copied faster than but 48 x 15 second cues).

At any time, you may press the EXIT key to abort the copy and the whole process will be cancelled.

NOTE: In order to prevent you having an incomplete project on the destination disk, the project selected for copying is erased from the destination disk along with all associated audio when you press EXIT. This may take a second or two.

If you try to copy a project or library to another disk and a project or library of exactly the same name exists on the target disk, you will receive this prompt:

```
File exists on target disk!! Overwrite??
```

As this will erase the project and all its audio on the target disk, you are given a second level of prompting for safety's sake:

```
COPY FILE          Tracks: 1-16   Disk:4
*** WARNING ***
This will overwrite the project and its
audio! Be careful before proceeding!!
Are you sure? NO UNDO!
```

The EXECUTE key will flash and you should respond accordingly pressing EXECUTE to proceed and EXIT to cancel but please be careful because, as the prompt advises, it is not possible to undo this action.

The same process is used for disk duplication.

You may leave the COPY FILE page at any time by pressing EXIT.

****IMPORTANT NOTES REGARDING COPY ****

The COPY process copies the project/library and all referenced audio across to the target disk. This is to prevent audio becoming detached from the project or library with which it is associated. However, the copying process only copies across the audio associated with the cues plus a 10% 'handle' either side of the cue.

For example, imagine that you have a 5 minute continuous recording of assorted sound effects and you have used a mere 30 seconds of it in a project you have chosen to copy. On the source disk, that cue is referencing the full 5 minutes of audio (but only playing the relevant 30 seconds of it in the project). When you copy the project across, it will only copy the 30 second section you are using in the project (plus 3 a second 'handle' either side) NOT the full five minute piece of audio it originally came from. You may find therefore, that when you copy a project from one disk to another, the project on the target disk will use less disk space than the one on the source disk.

However, please note one important restriction regarding copying individual projects and libraries separately to another disk. Because the audio is copied each time you individually copy a project or a library, this will take up extra disk space on the destination disk. This will happen even when you copy two similar projects that reference the same audio.

For example, imagine you have two projects PROJECT 1 and PROJECT 2 on DISK 0 and both projects use exactly the same audio (PROJECT 2 being just a slight variation on PROJECT 1). If you were to select SINGLE FILE as the file type and individually copy each project to DISK 1 separately, you will find that the audio is duplicated, using up disk space. In this case, you should use ALL PROJECTS - this would copy both projects but would only copy the audio once.

In the event of you having, say, five projects on DISK 0 all using the same audio but you only want to copy PROJECT 1, 2 and 5 to DISK 1, select ALL PROJECTS and copy all five projects across in one operation (and hence only one version of the audio) and then, on DISK 1, delete projects 3 and 4.

The same is true when copying libraries.

DELETE FILES

In the disk DIRECTORY page, you can delete projects and/or libraries depending on the selection made in the FILE TYPE field. First select the type of file you wish to delete in the FILE TYPE field and then move the cursor to the file you wish to delete. Pressing DELETE will give you this prompt:

```
Delete selected file? NO UNDO!!
```

The EXECUTE key's LED will be flashing and you should press EXECUTE (YES) or EXIT (NO/CANCEL) accordingly. As the prompt tells you, there is no undo for this so please check carefully that the correct file is selected for deletion before proceeding. If in any doubt at all, press EXIT to abort.

If you press DELETE (F6) and the cursor is not on a file (i.e. it is on the DISK or FILE TYPE fields), the screen will pop-up the prompt:

```

DIRECTOR  Tracks: 1-16  Disk:4
NEW PR   Project 1
Project  Please select a Project e 7
SFX PR   Project 7
SELECT TYPE  COPY DELETE

```

This prompt will appear for a few seconds. You should move the cursor to the file you wish to delete and press F6 (DELETE) again.

If you try to delete a project that is currently loaded, you will receive this prompt:

```

DIRECTOR  Tracks: 1-16  Disk:4
NEW PROJ 1 Project 1
Project 2 File in use       e 7
SFX PROJCT
SELECT TYPE  COPY DELETE

```

You should either load another project or create a new one and then return to the DISK page to delete the project you originally wanted to delete.

If you have deleted any files, when you leave the DIRECTORY page, you will receive this prompt:

```
Files have been deleted. Cleanup disks?
```

When a project or library is deleted, the audio associated with it is not deleted at the point of deletion. This may seem a bit odd but the reason for this is that if audio was deleted when you pressed EXECUTE, every time you delete a file, the system would have to go through a lengthy search process to check if the audio associated with that file is referenced anywhere else (i.e. in other projects and/or libraries) and this could take some time.

As a result, to make the deletion process quick, only the file itself is deleted. Then, when you come to leave the DISK page, you are offered the choice of 'cleaning' up the disk. What this means is that the machine will search any connected disks and look to see if the audio associated with the files you have deleted is used anywhere else. If any part of it is referenced by any other projects and/or libraries, the audio will not be deleted. If, however, the audio associated with the file(s) you have deleted is not used by any other project and/or library, the audio will be erased from disk, thus freeing up extra disk space.

To save yourself some time, if disk space is not a problem, you can choose to ignore this prompt by pressing EXIT and you can come back to this when it's more convenient. If you wish to proceed and erase any unreferenced audio, press the flashing EXECUTE key (see later - CLEANUP DISK).

DISK MANAGEMENT

RENAMING FILES

It is also possible to rename files in the DIRECTORY page by placing the cursor over the file you wish to rename and typing a new name from a PS/2 keyboard connected to the RE32. As you start typing, you will receive this prompt:

```
Enter name, then press EXECUTE
```

When you have finished, press RETURN (or EXECUTE on the RE32's front panel) to complete the name and RETURN again to enter the name. Press ESC(ape) to abort the naming process on the computer keyboard (or EXIT on the RE32's front panel).

If you try to rename a project that is currently loaded, you will receive this prompt:

```
DIRECTORY          Tracks: 1-16          Disk:4
NEW PROJ 1          Project 1
Project 2          File in use          bene 7
SFX PROJCT
SELECT TYPE          COPY DELETE
```

You should either load another project or create a new one and then return to the DISK page to rename the project you originally wanted to rename.

BACKING UP YOUR WORK

As disks become full or projects get finished, you need some way to backup the material for safe keeping so that, if needs be, you can come back to it at a later date. You could, of course, simply copy it all off to another disk of some form but this can be an expensive way of doing it.

A more cost effective method is to backup to some form of tape medium and the Akai DD/DR-Series machines allow you to backup the contents of your disk(s) to SCSI tape drives via the SCSI connection or, on the DD1500, to an ordinary DAT machine via the digital I/O. These functions are accessed by pressing BACKUP (F5) in the DISK UTILITIES page.

When you press BACKUP, you will see this screen:

```
DISK UTILITIES   Tracks: 1-16   Disk:4
Free on disk : 03:52:03:16.73
Total capacity : 1931 Mb
Disk used : 657 Mb
Device:         AUDIO DAT   SCSI TAPE
```

You should select the device you wish to backup to - AUDIO DAT or SCSI TAPE.

BACKING UP TO SCSI TAPE DRIVES

Assuming you press SCSI TAPE, you will be taken to this screen:

```
SCSI BACKUP     Tracks: 1-16   Disk:4
Title : Backup
To SCSI tape : 0
Backup type : SELECTED FILES
FORMAT|VERIFY|SELECT FILES|RESTORE
```

Before we look at the actual functions, an understanding of SCSI tape drives is in order.

SCSI tape drives can be regarded as slow, linear disk drives. A single tape can contain several backups. However, whereas a disk drive has just the one directory where information relating to the data on the drive is stored, a tape drive has a directory for each backup on the tape.

Of course, you may find it easier to keep track of backups by backing up each disk/project to its own SCSI tape (i.e. one tape will contain only the contents for one backup) but you may, if you wish, make several backups to one tape and then restore them individually by name if you prefer.

FORMATTING A TAPE FOR BACKUP

Before you can perform a backup, you must first format the tape so that the tape is set up to receive files and digital audio data. This done using the FORMAT key.

To format the tape, select the appropriate SCSI ID for the tape drive in the TO SCSI TAPE field. As with disk drives, the tape drive must not share the same SCSI ID as any other SCSI device on the buss. Once selected, press the format key. You will see this screen:



**** FORMATTING THE TAPE WILL PERMANENTLY DESTROY ITS CONTENTS ****

PLEASE BE CAREFUL BEFORE PROCEEDING

Because of the potential danger of accidentally formatting an existing tape, you must press SHIFT+EXECUTE to proceed. During the format, you will see the message "FORMATTING TAPE. PLEASE WAIT" pop up on the screen during the process. Once the process is complete, you will see the message "FORMAT COMPLETE". The tape is now ready for use.

NOTE 1: *The format should not take long under normal circumstances (15 seconds or so) but if the tape has been used several times before, you may find it takes longer as the system may need to check the tape to make sure it is suitable for use. Under extreme circumstances, it may need to check the entire tape and so could take some time. If this is the case and the formatting seems to be taking a long time, you can press EXIT to abort the formatting process.*

To avoid this, it is recommended you always use new, unused tapes. It is also not a good idea to use tapes that may have been used to backup material from some other system (for example, a PC or a Macintosh™ computer or (heaven forbid!) some other disk recorder.

NOTE 2: *If you receive other messages such as DRIVE NOT READY or DRIVE BUSY, then there is a problem with the cable and/or the drive. Please check both. Is the drive switched on? Is there a tape in the drive? Are the cables connected securely? Is the SCSI buss terminated correctly? If everything seems correct but the problem persists, try moving the tape drive elsewhere in the buss (i.e. move from the end of the chain to the middle or vice versa). If the problem still persists, contact your AKAI professional dealer.*

If a message such as THE SELECTED SCSI ID IS A DISK DRIVE is shown, this indicates you have selected the wrong SCSI ID in the TO SCSI TAPE field. Please take the appropriate steps.

The fields on the SCSI BACKUP page are:

TITLE	You may give the backup a title of up to ten characters. This will be stored in the SCSI tape's directory and you will be able to use this name to selectively restore the backup in future in the event of you archiving several different backups to tape. Naming is done in the usual manner by typing on the external PC keyboard. If you do not specifically give it a name, the default name BACKUP will be used.
DISK	This selects the disk that will be backed up to the SCSI tape drive.
TO SCSI TAPE	This selects the SCSI ID of the tape drive.

<p>NOTE: As with any SCSI device, the tape's SCSI ID should be unique and should not share the same ID as another device on the SCSI buss.</p>

BACKUP TYPE	This selects what will be backed up to the SCSI tape. You may select:
SELECTED FILES	You may, via F3/F4, select specific files to backup. These may be projects or libraries.
ALL PROJECTS	You may backup all the projects on the selected disk.
ALL LIBRARIES	You may backup all the libraries on the selected disk.
ALL PROJS & LIBS	You may backup all the projects and all the libraries on the selected disk.
ENTIRE DISK	You may backup everything on the disk.

BACKING UP SELECTED FILES

Choosing **SELECTED FILES** in the **BACKUP TYPE** field will show this screen:

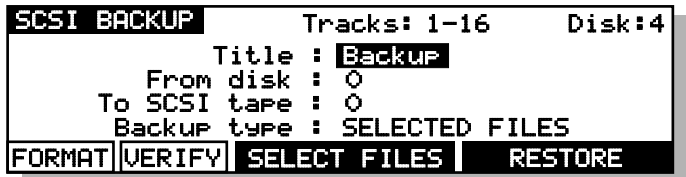

To actually select the files, press **SELECT FILES (F3/4)**. You will see something like this screen:

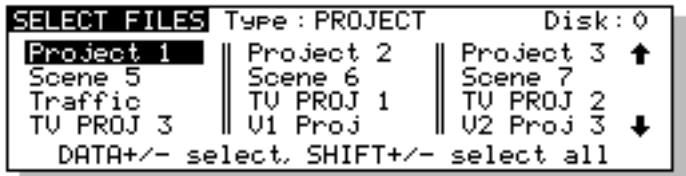

You can select **PROJECT** or **LIBRARY** in the **TYPE** field, You may select a disk to backup in the **DISK** field.

To select the file you wish to backup, move the cursor to the file name and press the **DATA +** key. A small block appears to the left of the file name to indicate it is selected for archiving. For example:

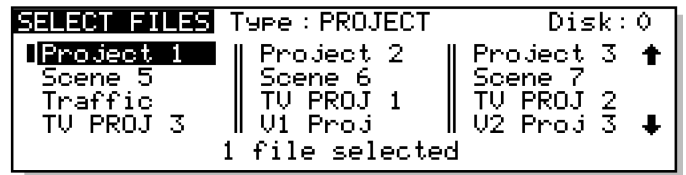

In this case, **PROJECT 1** is selected for backup. The bottom of the LCD will show how many files are selected. In this case, just one.

You may also select several files for backup in this way. For example, by moving the cursor to different file names and pressing the **DATA +** key, you may end up with something like this:

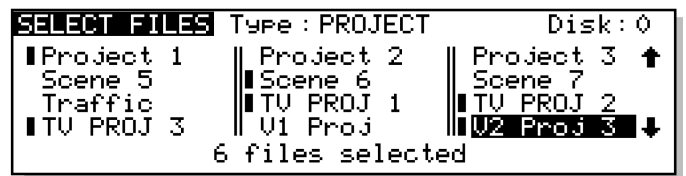

In this example, **PROJECT 1**, **TV PROJ 3**, **SCENE 6**, **TV PROJ 1**, **TV PROJ 2** and **V2 PROJ 3** are all selected for backup. The bottom of the LCD shows how many files are selected.

As in other disk pages, arrows appear to indicate files that are 'off-screen'. Use the **CURSOR UP/DOWN** keys to scroll through the list.

You may also select **ALL** the files shown on this page simply by pressing **SHIFT** and the **DATA +** key.

NOTE: This is the same as selecting the ALL PROJECTS or ALL LIBRARIES or ALL PROJS&LIBS option in the SCSI BACKUP TYPE field. However, whilst this may seem like an unnecessary duplication of a function, it might be useful if you want to backup all projects except one or two - i.e. press SHIFT and DATA + and then use DATA - to de-select those few files which you do not wish to backup. On a busy disk with many projects/libraries to backup, this may be more convenient than individually 'marking' every file you want to backup.

Files selected by mistake can be de-selected using the DATA - key. For example, moving the cursor back to SCENE 6 on this example and pressing the DATA - key would de-select it:

```

SELECT FILES Type : PROJECT Disk : 0
Project 1 || Project 2 || Project 3 ↑
Scene 5 || Scene 6 || Scene 7
Traffic || TV PROJ 1 || TV PROJ 2
TV PROJ 3 || U1 Proj || U2 Proj 3 ↓
5 files selected

```

At the point you press DATA -, you will see the number of files selected decreases by one (in this case, only 5 files are now selected).

Once you have selected the file(s) you want to backup, press EXIT to return to the main SCSI BACKUP page and proceed with the backup.

BACKING UP ALL PROJECTS AND/OR LIBRARIES

If you have selected ALL PROJECTS, ALL LIBRARIES or ALL PROJS & LIBS, all you need to do is press the flashing EXECUTE key. All the projects and/or libraries on the disk selected in the FROM DISK field will be backed up. If any projects and/or libraries use audio from any other connected disks, these too will be backed up to the destination SCSI tape.

The exact amount of time the backup will take depends on the amount of material being backed up. Backup speed is approximately five times real-time (i.e. ten minutes of audio will take approximately 2 minutes to backup).

BACKING UP AN ENTIRE DISK

As well as selectively backing up chosen files or backing up all projects and/or libraries, you may also make a duplication of the disk by selecting ENTIRE DISK in the BACKUP TYPE field.

NOTE: Although ENTIRE DISK may seem the same as ALL PROJS & LIBS, there is a difference. ALL PROJS & LIBS will backup everything from the selected disk but it will also backup any audio from other disks that are used in the projects and/or libraries being backed up. ENTIRE DISK, on the other hand, only backs up the audio on the selected disk, not any audio referenced on other disks. ALL PROJS & LIBS, therefore, is more suitable for backing up your work whilst ENTIRE DISK is a better selection to make if you just want to make a safety copy of a disk.

PERFORMING THE BACKUP

Regardless of the backup type you have selected, to actually perform the backup, simply press the flashing EXECUTE key. You will see this screen:

```
BACKUP IN PROGRESS
      Preparing tape
      Please wait!
      (EXIT to abort)
```

Here, the system is getting the tape ready for the backup. First of all, it will look at the tape's directory to make sure that there is no backup of the same name. If a backup of the same name exists on the tape, you will receive this message:

```
BACKUP IN PROGRESS
      A backup of the same name exists
      on this tape. Please insert a
      new tape or choose a different name.
Select      ABORT  CONTINUE
```

In this case, press ABORT and give the backup a new name and try again (i.e. press EXECUTE) or insert a new tape and press CONTINUE.

NOTE: You will need to specifically go to your tape drive use the front panel EJECT key to eject the current tape and insert a new one.

Assuming everything is ok, the system will then wind the tape to the first available space where it can write data. If the tape is a new, freshly formatted tape, this will be quite quick but if the tape contains several backups already and these contain a lot of data, it may take a while to wind to the first available area of the tape suitable for backing up to.

NOTE: You may see other messages pop up. These will be momentary - don't worry about these.

Once a suitable position on the tape has been located, the backup will begin and you will see something like this screen as the backup takes place:

```
BACKUP IN PROGRESS
      Writing Audio
      TRK 1  23 from disk 0.  4% done
      5 of 10 files.  1% done
      (EXIT to abort)
```

The screen shows the progress of the backup as it takes place and this is expressed as a percentage and as a highlighting bar. The percentage in the top line shows how much of the individual file has been backed up whilst the percentage in the bottom line shows how much of the entire backup has been done.

If any of the selected files use audio from any other connected disks, these too will be backed up to the destination SCSI tape (except in the case where ENTIRE DISK is selected). During the process, you may abort the backup by pressing the EXIT key at any time.

The exact amount of time the backup will take depends on the amount of material being backed up. Backup speed is approximately five times real-time (i.e. ten minutes of audio will take approximately 2 minutes to backup).

At the end of the backup, you will see this screen:



The system will rewind the tape to the start in readiness for the next backup. Exactly how long this takes depends on the amount of data on the tape.

Finally, you will see this screen display:

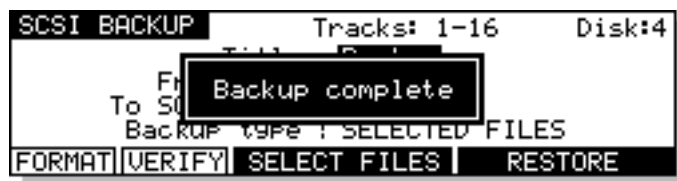

Press any key to continue.

VERIFYING A BACKUP

Once you have performed a backup, you may like to verify it to check that everything has backed up correctly. This is done by pressing the VERIFY key followed by EXECUTE. You will see this screen:

```
SCSI BACKUP          Tracks: 1-16      Disk:4
To:
Verify backup?
Press EXECUTE to verify
the entire backup.
```

You should press EXECUTE to continue, EXIT to abort. As the verification takes place, you will see this screen:

```
VERIFY IN PROGRESS
Verifying Audio
TRK 1  23 from disk 0.  4% done
5 of 10 files.  1% done
(EXIT to abort)
```

You may abort the process at any time by pressing the EXIT key.

NOTE: The VERIFY process does a comparison of what is on the source disk and what is on tape and the idea is that the disk contents and the tape contents must be identical for the verification to be successful. Because of this, the VERIFY process is best done immediately after a backup. In this case, you should have no problems as the two media should have identical contents. If, however, you make a new recording on the source disk or delete anything from the source disk after the backup, the contents of both media will not be the same and so you will receive messages such as "FILE XXXX MATCH NOT FOUND". This is telling you that either it has found something on the disk which does not correspond to what is on tape (i.e. you may have made a new recording) or it has found something on tape which it cannot find on the disk (i.e. you have maybe deleted something off disk).

It is not essential that you run the VERIFY process after a backup but, bearing in mind the potentially serious implications of a faulty backup, it is highly recommended. However, you will please note that the VERIFY process will take about two or three times as long as the backup took so whilst it's recommended you verify your backups, you might like to do it during a 'quiet moment'.

RESTORING A BACKUP

To restore data, in the DISK UTILS page press BACKUP. You will see this screen:

```

DISK UTILITIES   Tracks: 1-16   Disk:4
Free on disk : 03:52:03:16.73
Total capacity : 1931 Mb
Disk used : 657 Mb
Device:         AUDIO DAT   SCSI TAPE
    
```

Select SCSI TAPE. You will see this screen:

```

SCSI BACKUP     Tracks: 1-16   Disk:4
Title : Backup
To SCSI tape : 0
Backup type : SELECTED FILES
FORMAT|VERIFY|SELECT FILES|RESTORE
    
```

Press RESTORE (F5/6). You will see this screen:

```

SCSI RESTORE    Tracks: 1-16   Disk:4
Title : Backup
From SCSI tape : 0
Restore type : SELECTED FILES
SELECT TITLE|SELECT FILES|BACKUP
    
```

As you can see, this is basically the reverse of the SCSI BACKUP page. The fields are:

- DISK Selects the disk the data will be restored to.
- TITLE Selects/shows the name of the backup you wish to restore.
- FROM SCSI TAPE Selects the tape drive the data will be restored from.
- RESTORE TYPE Selects what will be restored to the disk.

You can also select ENTIRE BACKUP as the restore type and this will restore everything in the selected backup.

You may also select to restore only libraries by selecting ALL LIBRARIES. In this case, even if a backup contains projects, these will be ignored. Likewise, if you select ALL PROJECTS, only projects found will be restored and any libraries in the backup will be ignored.

You may also specifically select the files you want to restore by selecting SELECTED FILES. To actually select the files for restore, press SELECT FILES (F3/4). First, you will see this screen:

```

SCSI RESTORE      Tracks: 1-16      Disk:4
-----
Press EXECUTE to read the directory
for backup "Animals LB"
from the tape.
-----
Read backup directory from tape?
    
```

The system needs to read the directory on the tape to know what files are contained in it. Press EXECUTE to proceed (or EXIT to cancel). You will see this screen:

```

SEARCH IN PROGRESS
-----
Reading directory from tape.
Please wait!
-----
                (EXIT to abort)
    
```

Depending on the complexity of the backup, after a short while, you will be taken to something like this screen:

```

SELECT FILES      Type : PROJECT
-----
Project 1 || Project 2 || Project 3 ↑
Scene 5  || Scene 6  || Scene 7
Traffic  || TV PROJ 1 || TV PROJ 2
TV PROJ 3 || U1 Proj  || U2 Proj 3 ↓
-----
DATA+/- select, SHIFT+/- select all
    
```

Here, you may select the files in the backup you wish to restore (if you have used SELECTED FILES as the backup type, you will already be familiar with this and operation is the same). Move the cursor to the file you wish to restore and press the DATA + key. A small block will appear alongside the filename to indicate that it has been selected:

```

SELECT FILES      Type : PROJECT
-----
|Project 1 || Project 2 || Project 3 ↑
Scene 5  || Scene 6  || Scene 7
Traffic  || TV PROJ 1 || TV PROJ 2
TV PROJ 3 || U1 Proj  || U2 Proj 3 ↓
-----
                1 file selected
    
```

The number of files selected for restore will be shown. Continue to mark the files you wish to select in this way. Press EXIT to return to the main SCSI RESTORE page.

DISK MANAGEMENT

Regardless of the type of restore you have selected², the process is initiated by pressing the EXECUTE key. You will see this screen display:

```
RESTORE IN PROGRESS
  Reading directory from tape.
  Please wait!
  (EXIT to abort)
```

Followed by this screen:

```
RESTORE IN PROGRESS
  Analysing cues
  Library "Animals ", 0% done
  Please wait!
  (EXIT to abort)
```

After a short while (depending on how many cues are in the backup), you will see this screen:

```
RESTORE IN PROGRESS
  Restoring Audio
  TRK 1 23 from disk 0, 4% done
  5 of 10 files, 1% done
  (EXIT to abort)
```

You will see the backup being restored onto the selected disk. The percentage figures will change as the restore progresses and highlighted bar will move across the bottom of the LCD to further indicate progress.

You will then see this display:

```
RESTORE IN PROGRESS
  Resolving cue references
  30% done
  Please wait!
  (EXIT to abort)
```

What the system is doing here is 'fixing up' all references to the audio data that has just been restored so that any projects and/or libraries that may use the cues/clips that have just been restored will play correctly. The percentage will change to indicate progress and the exact length of time it takes depends on the amount of 'fixing up' the system has to do (i.e. how many different places the audio you have restored is used).

Finally, you will see this screen display:

```
SCSI RESTORE   Tracks: 1-16   Disk:4
  Restore complete
  To SD
  Restore
  FILES
  SELECT TITLE | SELECT FILES | BACKUP
```

² There is a difference when ENTIRE BACKUP is selected. This will be explained later.

If, when you perform the restore, a library or project on the disk you are restoring to shares the same name as one being restored, you will see this prompt:

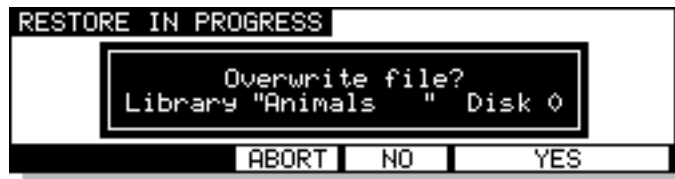

Pressing ABORT (F3) will abort the whole restore process. You will see this screen:



If you press NO (F4), the restore will proceed as described on the preceding page but a new project or library will be created with a new automatically numbered name. Using the above example, pressing NO at the OVERWRITE prompt would create a new library called ANIMALS 1 (or some other suitably numbered library of that name).

Pressing YES (F5/6) will cause the restore to proceed as normal and as described on the previous page and the selected library on disk will be overwritten.

****Be careful that you don't overwrite a valuable project or library ****
There is no means to retrieve or salvage it once it has been overwritten.

RESTORING THE ENTIRE BACKUP

Restoring an entire backup is essentially the same as the other types of restore except that when you press EXECUTE, you are prompted thus:



You have the option to completely wipe the selected disk prior to restoring data back onto it. Respond by pressing NO or YES/EXECUTE as appropriate (or EXIT to abort).

***** BE VERY CAREFUL WITH YOUR SELECTION *****
If you select YES, the data you erase cannot be retrieved or salvaged.

NOTES ABOUT BACKUP/RESTORE

When backing up data to disk, there are a few things you should be aware of.

- When ALL PROJECTS, ALL LIBRARIES, and ALL PROJS & LIBS are selected as the BACKUP TYPE, if any projects and/or libraries use audio from other disks, this audio will also be backed up. However, when you come to restore this data, the material from the other disks will be restored to the single 'destination' disk selected in the TO DISK field. For example:

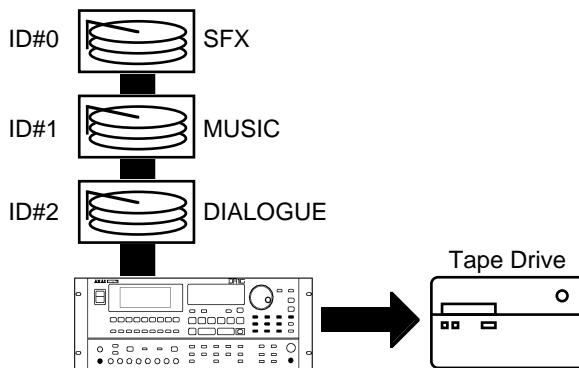

BACKUP

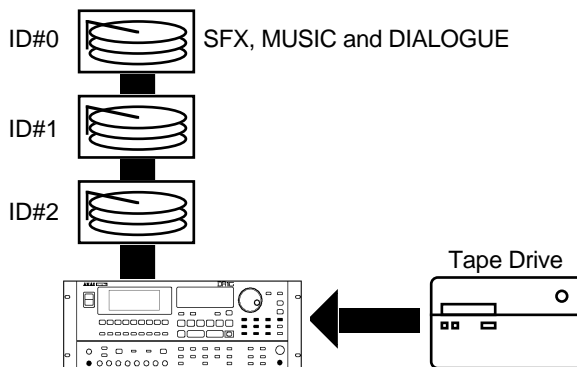

RESTORE

In the above example, SFX, music and dialogue from disk IDs 0, 1 and 2 are backed up to tape but these will be restored to the disk selected (in this example, Disk ID#0)

In other words, you should ensure that the destination disk for the restore is large enough to accommodate all the material (the RE32 will inform you if it isn't).

- If the data you are trying to backup to tape is larger than that which the tape can hold (or if there is already quite a bit of data on the tape), the backup will be done across two or more tapes. The RE32 will prompt you if this is the case and will tell you to insert another tape. If the tape is unformatted and unsuitable for use, you will be prompted to format the tape whereupon the backup will continue.

Of course, there is nothing wrong with this practice but it may get awkward trying to keep track of your backups and so, in view of this, to avoid this situation, you might prefer to use new, freshly formatted tapes when attempting a backup.

SUGGESTIONS FOR BACKUP/RESTORE

- Try not to re-use tapes. They are relatively inexpensive to buy and potentially carry very expensive data so it is not wise to economise.
- Do not use ordinary audio tapes unless you're really stuck as tapes made specifically for backup will be more reliable.
- Try to organise your backups sensibly to make restoring them easier.
- In much the same as in 'the old days' of 1/4 inch and multi-track tapes, try to ensure that the tape box is well labelled. Include any relevant information regarding the data stored on it. Include dates, client names and anything else you think appropriate that will make recognition of the material and the restore that much easier. Remember! It might not be you who restores it but somebody completely unfamiliar with the data.
- Store and treat the tapes carefully. Just because the media is small doesn't mean it doesn't deserve the same respect as a hefty 10" reel of master tape.
- Naturally, keep backup tapes away from magnetic sources such as monitor speakers, etc..
- If you have to send the backups anywhere, make a copy of them first.
- When sending tapes anywhere, package them well in a suitable padded envelope or box and wrap the tape in aluminium foil to help prevent damage from stray magnetic interference.
- Always write protect the tape. It may be a nuisance should you try to backup to it and get an error message but this is better than accidentally formatting it or overwriting existing backups.
- If you are travelling abroad with your backups, take them as hand luggage. Although the X-ray machines are supposed to be safe, you may be able to persuade airport security to have them manually inspected (normal luggage is often subjected to high power X-ray inspection that may not be too kind on the tape). Leave a copy at home just in case.
- Keep backups away from liquids, etc..
- Do not leave tapes lying around in vehicles, especially on hot days.

TAKING CARE OF YOUR TAPE DRIVE

Tape drives need to be taken care of quite carefully. You should refer to your drive's operator's manual for more details on this but some general guidelines are:

- As routine maintenance, the heads should be cleaned after every 25 hours or so of use. Basically, clean the heads regularly.
- To clean the heads of your drive, only use the head cleaner recommended in your drive's documentation.
- If your drive is a SCSI DAT drive, do not use standard audio DAT head cleaners.
- If you are using a SCSI DAT drive, avoid using audio DATs. Use only those tapes recommended by your drive's manufacturer.
- Keep the drive in a dust free environment. Dust on the heads could lead to a loss of data integrity and failed backups/restores.
- Don't smoke near the tape drive. This can really clog the heads!
- Do not try to use the tape drive if you move it from environments of differing temperatures and humidity. Moisture on the head as a result of condensation could damage the tape. If you must move the drive from one place to another, turn it on and leave it for a while before attempting to use it to give any condensation a chance to evaporate. Consult your drive's operator's manual for details on this.
- If you must manually eject the tape, there can be a few seconds delay before the tape is ejected. Do not power down the drive in this period as you may damage the heads and/or the tape.

Also, don't forget to pay attention to the normal considerations of SCSI:

- Make sure the total length of the buss doesn't exceed 6 metres.
- Make sure the correct devices are terminated (this should be the first and last in the chain with all other being unterminated).
- Make sure that no devices on the buss share the same SCSI ID.

Etc..

ARCHIVING DATA TO DAT

Selecting AUDIO DAT in the BACKUP page takes you to this page:



Here you may backup the contents of your disk to a normal DAT machine via the digital audio I/O.

The parameters in the ARCHIVE page are:

DISK	This selects which disk you will archive.	
ARCHIVE TYPE	Here you may select the type of item you wish to archive. The options are:	
	SINGLE FILE	<p>This allows you to select a single file for archiving. When SINGLE FILE is selected, FILE TYPE and FILE NAME fields appear below the ARCHIVE TYPE field where you may select the type and the file for archiving.</p> <p>The SINGLE FILE option is very convenient for archiving single projects to DAT.</p>
	ALL PROJECTS	This will archive all projects and any audio associated with them.
	ALL LIBRARIES	This will archive all libraries and any audio associated with them.
	ALL FILES	This will archive all projects and libraries and any audio associated with them. It will not archive any unreferenced audio.
	ALL LIBRARIES	This will archive all libraries and any audio associated with them.
	DUPLICATE DISK	This makes a complete copy of everything on the disk to the DAT.

NOTE: When ALL PROJECTS, ALL LIBRARIES, ALL FILES and DUPLICATE DISK are selected, the FILE TYPE and FILE NAME fields are not shown.

If the selected machine is a DD1500, pressing DAT OPTIONS (F1/F2) will give this screen display:

```
ARCHIVE/RESTORE DAT OPTIONS
Archive tape length : DAT30
Archive digital output : MIX A
Restore digital input : DIG A
```

Here you may select which of the digital I/Os you will use for the archive/restore. For restoring, you may choose between DIG A or B (or if optional digital I/Os are fitted, DIG C or D) and for archiving, you may select MIX A or MIX B outputs.

In both of these screens, you may also set the tape length of the DAT you are restoring to and you may choose between DAT 30 (30 minute tapes) to DAT 180 (3 hour tapes). The archive process uses the stereo capacity of the DAT tape so a DAT 120 can hold 4 hours worth of material (you can do your own maths for the other tape lengths!).

To perform the archive, insert a blank DAT tape into the DAT recorder and make sure it is rewound to the start. Put the DAT recorder into 'record pause'. Get the selected machine ready for archive, 'unpause' the DAT and then press ARCHIVE (F5/F6). The archiving process will begin.

If the tape runs out during the archive, you will be prompted to insert another.

The time taken to archive is just a little longer than real-time (i.e. one hour of material will take just over one hour to archive). However, please note the capacity of DAT for archiving purposes. A DAT 60 can hold approximately 600Mb of data making it a bit too small to archive one side of a 1.3Gb MO disk (650Mb - approximately 2 hours of audio at 44.1kHz) but because a DAT 90 can hold approximately 900Mb you could easily archive one side of a 1.3Gb MO disk to such a tape. A DAT 120 could be used to archive a 1Gbyte hard disk. Larger hard disks will need to be archived over several tapes and you may prefer to archive your projects and/or libraries individually in this case as you can organise the order you want the items archived and decide which tapes you want them on. Furthermore, with single files archived in this way, when you come to restore, you don't have to do the full restore but you can selectively restore projects you are interested in.

**** IMPORTANT NOTE ABOUT RESTORING SINGLE ITEMS ****

YOU CANNOT RESTORE A SINGLE PROJECT/LIBRARY TO A DISK TO ADD TO OTHER PROJECTS/LIBRARIES ON THAT DISK!!!

The restore process first erases the disk and then restores the audio onto the disk. In other words, you cannot make a compilation of projects and libraries from different archive tapes onto one disk because each time you restore an archive, the disk will be erased.

Please ensure that you use a blank disk (or one you are happy to erase) when restoring.

AKAI professional CANNOT BE HELD RESPONSIBLE FOR DATA LOST IN THIS WAY.

NOTES ABOUT ARCHIVING TO AUDIO DAT

- *If your disk is quite large and has a lot of material on it, then larger tapes are recommended. You will note, however, that if the tape runs out during the archive process, you will be prompted to insert another tape. It is important, therefore, to set the tape length field to match that of the actual tape you are using otherwise the archive process will go wrong.*
- *When archiving across several tapes, you must use blank DAT tapes that are rewound to the very start of the tape when archiving. Failure to do so will cause problems. For example, if you are using a 120 tape and have selected DAT 120 in the ARCHIVE TAPE LENGTH field, but start it half way through the tape, the system will archive for a setting of DAT 120 (i.e. it is set to archive for two hours and then prompt you) but, of course, the tape will have run out after an hour, the system will not know this and will continue to archive as though a DAT 120 tape is being used.*
- *DAT180 tapes can be used but, because the tape is rather flimsy, please use with caution.*
- *Because DCC (digital compact cassette) and MiniDisk use data compression, although you can appear to be archiving successfully to either of these two mediums, the restore will fail. AKAI professional cannot be held responsible for the loss of data archived to DCC or MiniDisk.*
- *When data is archived, data files (i.e. projects, libraries, etc.) are written several times to the DAT tape to overcome the remote possibility of dropouts, tape damage, etc. (the audio is only written once to the tape, however). Whilst every effort has been made to ensure reliable archiving and restoring of data, copying to another disk is more reliable and is therefore recommended. AKAI professional cannot be held responsible for data lost when archiving to audio DAT.*
- *When data is archived to DAT, please ensure that the tape is stored carefully and in its proper case.*
- *When large amounts of data are archived across several DAT tapes, try to keep all the tapes together for a successful restore at a later date.*
- *Label the tapes carefully - it will make restoring them that much easier.*
- *It is a good idea to 'write protect' the DAT tape.*
- *Do not leave the tape anywhere where it may be ruined by accidental spillage of liquids.*
- *Do not leave the tape anywhere where it may be affected by dust.*
- *Do not leave the tape anywhere where it may be affected by adverse heat (i.e. in vehicles, near to radiators or other such heaters, etc.).*
- *Do not leave DAT archives close to strong magnetic fields (high powered speakers, TV/ computer/video monitors, etc.).*

RESTORING FROM DAT

Pressing RESTORE in the ARCHIVE page will show this screen display:

```
RESTORE FROM DAT  Tracks: 1-16  Disk:4
                To disk : 0
Restoring will totally wipe this disk!
DAT OPTIONS  RESTORE  ARCHIVE
```

Here you may restore the contents of a DAT back to the disk via the digital audio I/O.

To connect your DAT machine, connect the digital output of the DAT machine to the digital inputs of the selected Akai DD/DR series machine (you can set which one will be used in the DAT OPTIONS page).

The DISK parameter allows you to select which disk you will restore to.

DAT OPTIONS (F1/F2) has the same function in RESTORE as it does in ARCHIVE. Please refer to ARCHIVE for details on the DAT OPTION page.

With a DR16pro, you may also choose to restore from an Alesis ADAT machine using the optional ADAT interface card. If the selected machine is a DR16pro, pressing DAT OPTIONS (F1/F2) will give this screen display:

```
ARCHIVE/RESTORE DAT OPTIONS
Archive tape length : DAT30
Archive/Restore Type : DAT
```

Here, the ARCHIVE/RESTORE TYPE field allows you select MULTI-OPTION allowing multi-channel audio restore via a digital audio option card from an Alesis ADAT.

To restore an archive, insert the appropriate tape into the DAT machine and rewind it so that it is at the start of the tape. Press RESTORE (F3/F4). You will receive this prompt:

```
Erase everything? SHIFT+EXEC to confirm
```

Because restoring will erase everything on the disk selected in the DISK field, this extra prompt is shown. Furthermore, to make accidental erasure even more difficult, you must press SHIFT+EXECUTE to proceed. If you have the slightest doubt about restoring at this point (proceeding will erase EVERYTHING off the selected disk!!!!) press EXIT to abort this prompt.

Assuming you wish to proceed, press SHIFT+EXECUTE. The system will wait and you should start the DAT machine. The restore will take place. Once you press SHIFT+EXECUTE, be warned - there is no going back! The disk will be erased and the restore will start.

**** IMPORTANT NOTE ABOUT RESTORING ****

THE RESTORE PROCESS FIRST ERASES THE DISK AND THEN RESTORES THE AUDIO ONTO THE DISK. PLEASE ENSURE THAT YOU USE A BLANK DISK (OR ONE YOU ARE HAPPY TO ERASE) WHEN RESTORING DATA FROM DAT.

AKAI professional CANNOT BE HELD RESPONSIBLE FOR DATA LOST IN THIS WAY.

As with archiving, the restore will take a little longer than real-time (i.e. an hour's worth of material will take just over an hour to restore. If the archive contains many very short clips, then archiving will take a bit longer).

CLEANUP DISK

CLEANUP DISK allows you to clear out redundant recordings and so save valuable disk space. Pressing CLEAN (F4) from the DISK UTILITIES page shows this screen:

```

CLEANUP DISK      Tracks: 1-16      Disk:4
Free on disk : 03:52:03:16.73
Total capacity : 1931 Mb
Disk used :      657 Mb
MINIMISE          CLEANUP

```

It is possible to have a disk full of unreferenced audio files. These are pieces of audio that have no association with any project or library. These are usually created when recording. For example, you make one recording and make a mistake. You drop in again over that, recording a new piece of audio. If the original recording is not in a library or another project, the audio associated with the original cue you recorded of it has become 'unreferenced' and is taking up disk space needlessly. Of course, if you keep recording over and over again on the same spot, you can fill your disk up fairly quickly. Also, if you delete a cue from a project or a clip from a library, you can end up with unreferenced audio. Another way audio can become 'unreferenced' is if you make a recording and then don't save the project. The functions in the CLEANUP page allow you to deal with this.

The CLEANUP functions are:

CLEANUP

This will only erase unreferenced audio but will not 'top and tail' the cues that are valid. However, because CLEANUP keeps all the audio that may be being referenced (no matter how small), it could be you will see no or only a small change in the FREE ON DISK field because unlike MINIMISE, if just one cue in one project uses one second of a ten minute recording, the whole ten minutes will be kept. If you need to free up a further nine minutes and 59 seconds, use MINIMISE. Pressing CLEANUP DISK (F1/F2) will give this message:

```

Delete clipboards?  NO  YES

```

Because audio may be being referenced by the EDIT CLIPBOARD, you could try a cleanup and end up with no appreciable increase in available disk space. This option allows you to select whether you want the clipboard to be deleted as well. You should make your choice accordingly using F5 or F6 as appropriate.

Pressing F5 or F6 will give this final safeguard prompt:

```

CLEANUP DISK      Tracks: 1-16      Disk:4
WARNING! Careless use could destroy
           your valuable recordings!
Please ensure that you have read and
understood the operator's manual
EXIT to abort/SHIFT+EXECUTE to proceed

```

When performing a cleanup, you should be aware that it is possible to have a project on a removable disk but for the audio for that project to exist on another disk (maybe the project is on an MO but the audio associated with it is all on a fixed hard disk). If the removable 'project' disk is not present on the system when you perform a cleanup, you run the risk of losing all the audio for that project. The reason is simple...

The CLEANUP function works by searching all the projects and libraries on all the disks currently attached to the system and it establishes what audio is being used by those projects and libraries and what is not. It then deletes any audio NOT being referenced by those projects and libraries from the disks.

DISK MANAGEMENT

If the audio associated with a project on a removable disk is on another hard disk and the removable disk is not in the system when you run CLEANUP, what will happen is that the system will search through all the projects/libraries it can find on the system in order to establish what audio should be kept and what should be deleted. Of course, it won't find the removable disk because it is missing and so assumes that all the audio that it can find on the hard disk(s) related to the project on the removable (which is missing, of course) is unreferenced and will therefore delete it. When you come to insert the removable disk and try to play it, it will show that all the audio associated with it is missing and the project will be rendered unplayable.

Press EXIT to abort or, if you are sure you can proceed safely and no disks are missing from the system, press SHIFT+EXECUTE but...

**BE VERY CAREFUL BEFORE PROCEEDING AS YOU MAY IRRETRIEVABLY DESTROY
A PROJECT ON A DISK MISSING FROM THE SYSTEM.**

During the cleanup process, the bottom of the LCD will show:

Cleaning up disk. Please wait...

The cleanup process will delete all unused audio on any disk connected to the system. Depending on the amount of unused audio, this could take a while so do this in a quiet moment!

NOTE: *If all this looks a bit worrying, our apologies but these prompts are provided to safeguard against you accidentally losing valuable data. The fact is that there is no good reason why you should have your project on one removable disk and all the audio associated with it on another and it is a practice that should be avoided. Presumably, the reason a removable disk is used is so that it can be taken elsewhere for playback. If all the audio exists on another disk, then it won't play anywhere else successfully.*

MINIMISE DISK

This will also erase any unreferenced audio on the disk but will also 'top and tail' the recordings, discarding any audio that is not actively referenced to any project and/or library. This is the most efficient cleanup routine as it gets rid of ANY audio not being used leaving you only with the audio that is actually relevant to any projects and/or libraries on disk(s). Pressing MINIMISE will give this prompt:

May take hours! CANNOT BE ABORTED! OK?

Because the machine has to go round and top and tail every piece of audio affected by the MINIMISE function, it can take a long time. After that, it has to 'fix up' all the cues that have been affected in all the projects/libraries and this will also take time. The exact length of time, of course, depends on the amount of audio being minimised but it is recommended you do this at the end of the day, maybe even leaving it to run overnight!

**** IMPORTANT ****

The MINIMISE function cannot be aborted once you have started it.

***DO NOT, UNDER ANY CIRCUMSTANCES, SWITCH THE SELECTED MACHINE OFF
DURING MINIMISE.***

***IN THE EVENT OF ACCIDENTALLY PROCEEDING WITH THE MINIMISE FUNCTION
AND THEN CHANGING YOUR MIND, ONCE THE PROCESS HAS STARTED, IT WILL
HAVE TO BE LEFT TO CONTINUE THROUGH TO THE END.***

***SWITCHING THE SELECTED MACHINE OFF DURING THE MINIMISE PROCESS WILL
CAUSE IRREPARABLE DAMAGE TO YOUR DATA!!***

Pressing EXECUTE will cause this prompt to be displayed:

```
CLEANUP DISK      Tracks: 1-16      Disk:4
WARNING!  Careless use could destroy
           your valuable recordings!
Please ensure that you have read and
understood the operator's manual
EXIT to abort/SHIFT+EXECUTE to proceed
```

As described above, because it is possible for projects and audio to exist on separate disks, if a project disk is missing from the system, you may cause data to be lost if a disk is missing from the system. Please see the explanation given in CLEANUP regarding this and please proceed with caution.

DISK COMPATIBILITY

DISK COMPATIBILITY

MACINTOSH

The Akai DD/DR-Series of machines are able to read and write certain files to Macintosh HFS format disks. When a Macintosh HFS format disk is accessed by pressing the DISK key, you will see the following screen:



In the TYPE field where you can select the type of file you want to load. The current options are:

- OMF To load an OMF (Open Media Framework) file allowing playback of audio created with systems such as Avid AudioVision® or MediaComposer®.
- PT 3.2 To load a Session file created on a Digidesign "Protools 3.2" system.
- PT 4 To load a Session file created on a Digidesign "Protools 4" system.
- PT 24 To load a 24-bit Session file created on a Digidesign "Protools 24" system. This option will only be available when the selected machine supports 24-bit audio (e.g DR16pro, DD8plus).
- ALL FILES To view all files on the selected disk. This may be used to select any OMF files that are not recognised by the RE32. This may occur if an OMF file was created on a non-Macintosh system.

NOTE: Due to the limited screen size, the RE32's LCD does not show the individual folders on the disk that would normally be shown on a Macintosh screen. Instead, the display shows a list of all files of the selected type on the disk. In practice, most disks will only contain a few 'project' files and a large amount of audio, so it should be relatively easy to find the required file.

Some files created by Macintosh applications may contain more tracks of audio than can be loaded in to the selected Akai machine. In this case, you may select to use several machines to playback the audio with certain tracks playing from each machine. Pressing the TRACKS key (F3/F4) will take you to the IMPORT TRACK MAPPING page which can be used to select the tracks that will be imported:

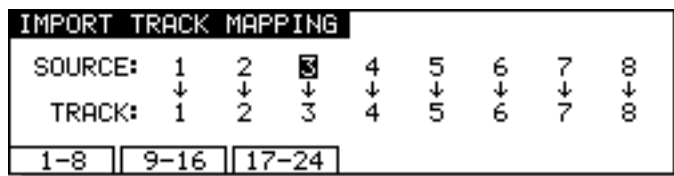

Soft keys F1,F2 and F3 can be used to quickly select tracks 1-8, 9-16 or 17-24. Alternatively, you can select an alternative combination of tracks to import by moving the cursor to the required playback track field and using the DATA +/- keys to select the audio track that will be imported from the file. On 16 track machines (such as the DR16pro, DD1500 or DD16PB), the SCROLL VIEW keys may be used to select sources for playback tracks 9-16.

PROTOOLS IMPORT

After moving the cursor to the required Session file, press the EXECUTE to import the selected file. The display will change to show the following screen and the progress bar at the bottom of the screen will indicate that the file is being imported.



As part of its normal operation, Protools renders all fade files as separate audio files on disk. When a Protools Session containing fades is loaded into the system, you will be given the option to use the pre-computed files or replace them by real-time fades for playback:



If you select YES, the system will load and playback all fade-regions from the rendered fade files on disk. If you have created any custom fades in Protools, you should choose this option to ensure the system plays back the file correctly.

If you select NO, the system will perform real-time fades in each fade region. This option will give the best performance from the system (as there will be less disk activity) and will also allow easier editing of the Session.

NOTE: Some systems that create Protools Session files (including Digidesign's "OMF Tool" and the Akai DD/DR series machines themselves) do not actually render fade files. If Session files from these systems are loaded into the system with the 'use pre-computed fades' option, the fade regions will not contain any audio (and will be shown in yellow on the RE32's VGA).

CREATING PROTOOLS SESSIONS

When a Macintosh format disk is connected to the selected machine, the NEW PROJECT page allows creation of a new Protools Session. This page is accessed by pressing NEW (F2) on the LOAD (MACINTOSH) page.



A new field, TYPE, has been added to this page. The TYPE field is used to select the type of project that will be created. The options available will depend on the format of the selected disk.

The options available are:

- | | |
|-------|--|
| AKAI | To create a new AKAI project on an Akai format disk. |
| PT 4 | To create a new "Protools 4" Session on a Macintosh format disk. |
| PT 24 | To create a new "Protools 24" Session on a Macintosh format disk. This option will only be available when the selected machine supports 24-bit audio (e.g DR16pro, DD8plus). |

When a new Session file is created, a folder with the new Session's name will be created at the root level of the selected disk. The new Session file is placed inside this folder together with folders for Audio Files and Fade Files. All SD-II or AIFF files recorded into this Session will be placed into the folder labelled 'Audio Files'.



WAVEFRAME

Certain Akai DD/DR-Series machines (including the DD8plus and DD1500) are able to read project files created on Waveframe disks including those from the Timeline MMR-8. When a Waveframe format disk is selected by pressing the DISK key, you will see the following screen:



The FILE TYPE field allows you to select the type of file you want to load. Normally, this should be left on PROJECT to view the available projects on the disk. ALL FILES can also be selected to view a list of all the files on the disk.

As with Macintosh disks, you can select which tracks you want to load from the PROJECT using the IMPORT TRACKS page accessed by pressing the TRACKS key (F3/4)

After selecting the project you wish to load, pressing EXECUTE will start the import process and the following screen will be shown:

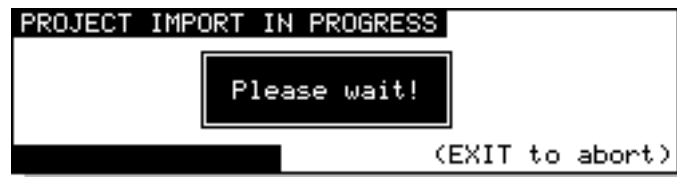

NOTE: Waveframe disk compatibility functions are only supported by the Akai DD8plus and DD1500. These pages will only be accessible when one of these machines is selected.

DISK COMPATIBILITY

FAIRLIGHT MFX3PLUS

Certain Akai DD/DR-Series machines (including the DD8plus and DD1500) are able to read files created on Fairlight MFX3^{plus} systems. The Fairlight MFX3^{plus} supports two types of native disk format, RBF and FLFS. Currently, the Akai system is only able to recognise RBF formatted disks. When a Fairlight RBF format disk is selected by pressing the DISK, you will see the following screen:



The FILE TYPE field allows you to select the type of file you want to load. The Fairlight MFX3^{plus} stores all the information necessary to play a complete project (including all audio and edit information) in a file with the suffix '.MT'. The Fairlight MFX3^{plus} also allows a separate MDL (Media Description Language) file to be created which contains all the information to play the audio in the current project. This is identified with a '.DL' suffix.

The Akai system reads the MDL file rather than the Fairlight native project file, so it is necessary to ensure that this file is always created before the disk is removed from the MFX3^{plus} system.

NOTE: Fairlight disk compatibility functions are only supported by the Akai DD8plus and DD1500. These pages will only be accessible when one of these machines is selected.

MSDOS (FAT16)

Certain Akai DD/DR-Series machines (including the DD8plus and DD1500) support playback of disks created on the Zaxcom DEVA hard disk recorder. This is a location recorder which records audio to an internal hard disk and can mirror recordings to an external SCSI device such as an Iomega Jaz drive. The Akai system is able to read DEVA files which have been recorded as 16-bit Broadcast Wave or Sound Designer II files by the DEVA to a FAT16 format disk. The Akai system can also play back 2-channel 'Polyphonic' files created by the DEVA (where 2 audio channels are interleaved). It is not able to play back 4-channel polyphonic files.

When a FAT-16 format disk created by the Zaxcom DEVA is selected by pressing the DISK key, you will see the following screen:



Unlike other disk formats supported by the Akai system, the Zaxcom DEVA does not store any 'project' file on the disk. Instead, each audio file contains its own timestamp information. Press EXECUTE to import the DEVA audio files for playback.

NOTE: MSDOS/DEVA disk compatibility functions are only supported by the Akai DD8plus and DD1500. These pages will only be accessible when one of these machines is selected.

In this section, we will have a look at the SETUP functions we skipped earlier.

SYSTEM SETUP

The SETUP pages allow you to set certain parameters that will affect either the RE32, an individual machine or the system as a whole. These include setting sample rates, timecode types and inputs, external connections, etc. Once configured, your system settings can be saved so that you may personalise your operating system.

Pressing the SETUP key displays this screen:



The soft keys F1-F5 take you to the various setup menus. As there are more menus than soft keys, F6 is used as a “MORE” key to scroll through the list of menus in groups of five:



Many SETUP pages include a parameter in the top right hand corner labelled MACHINE. This allows you to select if parameter settings are applied to the system as a whole (MULTI) or to a single machine (referred to as ID1, ID 2 etc..).

SYSTEM SETUP

SETUP - MULTI

When MULTI mode is selected, pressing the SETUP key will display the following options:



The MULTI SETUP pages are designed to allow easy configuration of parameters that should be set identically on each machine connected to the system.

Pressing RATES (F1) will take you to the SYSTEM RATES page:

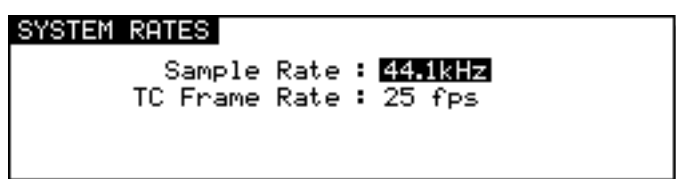

This page is used to set the system's global sample rate and frame rate.

The parameters are:

SAMPLE RATE This sets the system's sample rate. You may select 32kHz, 44.056kHz, 44.1kHz and 48kHz. Other options may be available depending on the facilities available on the connected machines.

On entry to this page, if all connected machines are set to the same sample rate, then this rate will be displayed. If not, the sample rate field will say "** DO NOT MATCH **" until a new rate is selected.

NOTE 1: This page will only allow selection of sample rates that are supported on all the connected machines.

NOTE 2: Recordings made at a sample rate other than the selected sample rate will play back at the wrong speed. For example, if the sample rate is set to 44.1kHz and you try to play back a recording made at 48kHz, the recording will play back slow. Therefore, please make sure that your recordings are made at the correct sampling rate. Recordings made at different sample rates cannot be used in the same project.

TC FRAME RATE This shows the system's timecode rate.

This field is not editable, but instead serves as a visual check that all machines are configured correctly. If all machines are set to the same frame rate, then this rate will be displayed here. If not, this field will say "** DO NOT MATCH **".

Timecode frame rates can be individually set on each machine as explained later in the section on TIMECODE SETUP.

DISPLAY

Pressing DISP (F2) on the main MULTI SETUP page will take you to the DISPLAY page:



The parameters on this page are:

DISPLAY STYLE

This allows you to set the type of timecode you wish the RE32 to display. Normally, this is the same as the timecode type selected in the EXT. TIME SOURCE field on the SYNC page (and the RE32 will take care of this automatically) but you may choose to view another time display if you wish. The selections are:

AS EXT. TIME SOURCE - The time display style is automatically selected to be the same as the timecode selected in the EXT. TIME SOURCE field.

23.98 fps - 23.98 frames per second (24 frames per second with a 0.1% pulldown for use when synchronising film to NTSC video).

24 fps - 24 frames per second.

25 fps - 25 frames per second.

29.97 fps - non-drop 29.97 frames per second.

29.97 fps drop - drop frame 29.97 frames per second.

30 fps - non-drop 30 frames per second.

30 fps drop - drop frame 30 frames per second.

Feet, 24fps 16mm - feet and frames at 24 frames per second as referenced to 16 mm film.

Feet, 24fps 35mm - feet and frames at 24 frames per second as referenced to 35mm film.

Frames, 24fps - frames only at 24 frames per second.

Frames, 25fps - frames only at 25 frames per second.

Frames, 30fps - frames only at 30 frames per second.

Frames, 29.97fps - frames only at 29.97 frames per second.

Hr:Min:Sec:mS - time will be displayed in hours, minutes, seconds and milliseconds.

Seconds (Secs.mS) - time will be displayed in seconds and milliseconds only.

SYSTEM SETUP

25fps film (+4.1%) - display 25 frames per second but with a 4.1% playback speed offset for use when working with material that has been transferred from film to video.

24fps film (-4%) - display 25 frames per second but with a 4% playback speed offset for use in European film applications when working with material that has been transferred frame-by-frame from 24fps film to 25fps video.

MIDI B/B/C - time will be displayed as bars, beats and clocks as defined by the current MIDI tempo map (see the section on TEMPO MAPS for more details).

NOTE 1: *It must be said that some of the latter options are for use in very specialised applications. You will know if they are useful for you. The normal selection made is 24, 25, 29.97 or 30fps. Those working in film or cartoons may like to use other display styles.*

SUB-FRAMES This selects how many sub-frames will be displayed per frame.

Available selections are :

- | | |
|--------------|--|
| OFF | The sub-frame display is switched off |
| 10th Frames | Normal display with 10 sub-frames per frame |
| Film Perfs | This counts film perforations at 4 perforations per frame. |
| Video Fields | This counts video fields at 2 fields per frame. |

LCD CONTRAST This allows the contrast of the LCD display to be changed for better visibility by using the DATA +/- keys.

DISPLAY OFFSET

Pressing OFFSET (F6) on the DISPLAY page takes you to the DISPLAY OFFSET page:



When the OFFSET field is OFF, the timecode displays will show either absolute or relative time as selected. When the OFFSET field is ON, the timecode displays will show be adjusted according to the offset entered on this page.

FOOTAGE DISPLAY

When footage (Feet/Frames) display styles are selected on the SYSTEM 'DISPLAY' page, the current position is calculated using the MARK time as zero footage. Other timecode offsets are ignored. This allows a project to be setup with a TIMECODE RCV OFFSET for use when the project is loaded into a machine chasing LTC as well as a separate and unrelated footage zero. The MARK time is stored from the STORE LOCATE page.

RECORD SETUP

Pressing RECORD (F2) on the main MULTI SETUP page will take you to the RECORD SETUP page that we looked at earlier in the section on recording:

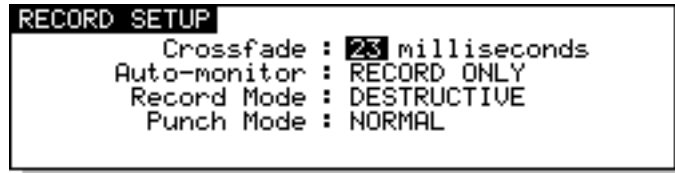

The parameters are:

CROSSFADE This allows a record crossfade of 0 to 80ms to be set.

AUTO MONITOR Here you may select how you will monitor the input signal. The default selection is RECORD AND STOP. With this selected, you will hear the input signal under the following conditions:

	STOP	RECORD	PLAYBACK
HEAR INPUT?	YES	YES	NO

RECORD TRACK'S PLAY SELECT KEY ON

	STOP	RECORD	PLAYBACK
HEAR INPUT?	YES	YES	YES

RECORD TRACK'S PLAY SELECT KEY OFF

The other selection you may make is RECORD ONLY. With this selected, you will only hear the input signal whilst actually recording, regardless of the status of the record track's PLAY select key. I.e.:

	STOP	RECORD	PLAYBACK
HEAR INPUT?	NO	YES	NO

RECORD TRACK'S PLAY SELECT KEY ON OR OFF

RECORD ONLY is useful when you only ever want to hear the input signal during record and at no other time. The system will take care of the switching automatically.

RECORD MODE In this field, you may select how the recordings you are about to make are stored in the project.

The default setting is PROJECT ONLY. With this selection, new recordings will be placed only into the currently active project. This selection is non-destructive - each time a new recording is made, existing files on disk from previous recordings will be unaffected.

You may also select DESTRUCTIVE. This is a special type of record mode that behaves more like traditional tape.

SYSTEM SETUP

As mentioned, recording is non-destructive by default but, sometimes when recording, it is possible to build up a lot of redundant audio on your disk, especially if you are dropping in and out over the same point time and time again (for example, when recording vocals). As a result, your disk can soon become full of audio you cannot access or use. The DESTRUCTIVE record mode goes some way to overcome this.

When DESTRUCTIVE recording mode is on, if you record over existing cues, the audio associated with the original cue may be erased from disk. However, you must either record over the original cue completely, or start recording from within a cue to past its end - dropping in and/or out half way through the cue will not cause the original cue's audio to be deleted from disk. For example:

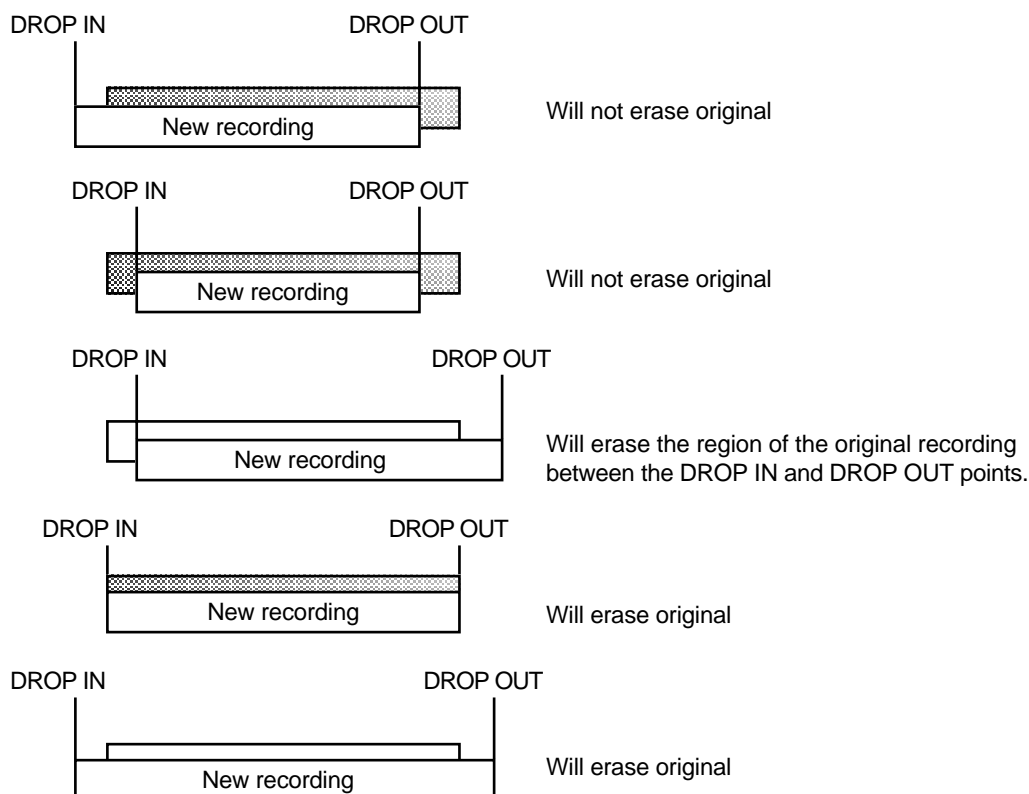

If you are using AUTO-PUNCH to drop in and out of record automatically and you have to keep repeating the auto-punch over and over again, the DESTRUCTIVE mode will be useful as it will help prevent the build up of unwanted recordings on your disk.

NOTE: There are certain considerations regarding destructive recording that you should be aware of.

- **THERE IS NO UNDO FOR RECORDINGS WHEN DESTRUCTIVE MODE IS USED.**
- After you have just loaded a new project, as a safety factor, recording over cues in that project will not delete their audio from disk and the original project cannot be damaged. If, however, you record over cues recorded since the project was loaded, newly recorded cues' audio will be deleted from disk.

The destructive record mode will go some way to avoiding the build up of unnecessary audio on your disk but, given the above points, there may be times when you will need to perform a manual cleanup or minimise.

**** WARNING ****

BECAUSE OF THE DESTRUCTIVE NATURE OF THIS FUNCTION, PLEASE MAKE SURE IT IS NOT INADVERTENTLY SELECTED WHEN RECORDING AS YOU RUN THE RISK OF LOSING VALUABLE DATA.

For example, if you are used to using non-destructive recording but receive a disk where DESTRUCTIVE record mode is enabled, you may be working in your usual way, thinking that new recordings are recoverable when, in fact, they are being deleted from disk every time you record over them. A good example may be where you are repeatedly dropping in over dialogue recordings, unaware that DESTRUCTIVE mode is set. You may think that you can retrieve 'out-takes' after the artist has left only to find that only the very latest recordings you made are available on disk. In this case, before recording over existing cues, please check that DESTRUCTIVE record mode has not been selected.

**** THERE IS NO UNDO WHEN DESTRUCTIVE RECORD IS USED ****

- PUNCH MODE** This selects how the system will respond if the record track selections are changed while the transport is in record.
- Available selections are:
- NORMAL** This is the default setting. The record track selections can not be changed while the transport is in record.
- TRACK KEYS** In this mode, the transport responds in the same manner as a conventional MTR. Pressing the REC and PLAY keys will put the system into a 'record-ready' condition waiting for tracks to be punched in from the track select keys. If no tracks are selected at the time the REC and PLAY keys are pressed, the REC key will flash. In this condition, when any of the track select keys are pressed the system will punch into record on the selected track(s) and the REC key will light steadily. When a track select key is pressed again, that track will be punched out of record.
- PRIMED** In this mode, recording will start immediately on selected tracks when the REC and PLAY keys are first pressed. After this, if new record tracks are selected, the appropriate track select key(s) will flash indicating that the track is in 'record-ready', but recording will not actually start until the PLAY key is pressed again while holding down the REC key. While in record, pressing the track select key of a track that is actually recording will punch that track out of record and back into the 'record-ready' state.

SYSTEM SETUP

NOTE: The TRACK KEYS and PRIMED punch modes are only available on 8 track machines (e.g. DD8, DD8plus). The PUNCH MODE parameter is not shown on this screen if other machines are being used in the system.

Press EXIT at any time to leave this page and return to the main RECORD screen.

SPEED

Pressing SPEED (F4) on the main MULTI SETUP page will take you to takes you to one of two pages depending on the synchronisation status of the system:

If the ON-LINE key is switched OFF (Internal Time Source), pressing SPEED (F4) takes you to the Varispeed menu :

```
VARISPEED
          Speed : +00.00%
          Varispeed : OFF
          Internal Time Source Only!
```

The parameters on the page are:

SPEED This sets a percentage by which the current playback speed will be altered. The range is +/- 50%.

VARISPEED This parameter enables or disables the varispeed playback function.

NOTE: It is not possible to record while VARISPEED playback is enabled.

If ON-LINE is ON (Chasing External Time Source), the SPEED key takes you to the External Source Speed page:

```
EXTERNAL SOURCE SPEED
          External Source Type : LTC
          External Time Format : 25 fps
          External Source Speed : +1.0000
          External Source Stability : 0.00
```

In this page, there are no user parameters. This is used only as a Time Source analyser, in order to check the Source format and quality (speed and stability).

TEMPO MAPS

The Akai DD/DR system allows you to create tempo maps for use when synchronising to MIDI sequencers. On the RE32, this function is accessed by pressing TEMPO (F5) on the main MULTI SETUP page. You will see this screen display:

Step	Type	Value	Time
1	T.Sig	4/4	001:01:00
2	Tempo	120.0 BPM	001:01:00

RESET START ADD LOCATE DELETE

Any machine in the system can act as a master to a sequencer synced to the machine using MIDI Time Code (MTC) or MIDI clock with Song Position Pointer (SPP). Of these two options, MTC is recommended for more accurate synchronisation as this is timecode via MIDI although if your sequencer does not have MTC, MIDI clock with SPP is a perfectly good way to synchronise your sequencer to the system.

The principle behind a TEMPO MAP on the Akai DD/DR system is that a machine can issue tempo changes and changes in time signature to the sequencer as part of a project. Without this, any variation of tempo in the recorded material on disk would not be passed to the sequencer and the two machines would very quickly drift out of sync. By placing tempo changes and time signature changes at the appropriate point, the sequencer can follow the system exactly. To achieve this, of course, your sequencer must be set to external sync so that the Akai DD/DR is in control of its tempo and time signature. ADDITIONALLY, THE SELECTED MACHINE MUST BE SET TO GENERATE MIDI SPP. This is done in the SINGLE MACHINE SETUP / SYNC page described later.

When working with MIDI sync in this way, it is recommended you use the MIDI BBC (bars/beats/clocks) time display style set in the SETUP / DISPLAY page.

NOTE: When MIDI B/B/C is selected as the TIME DISPLAY style, this will have implications on functions elsewhere on the RE32.

For example, if you use NUDGE, the DATA ENTRY +/- keys will nudge in beats and SHIFT +/- keys will nudge in clocks (if you need more accurate nudge amounts, select an H/M/S time display). The number of beats/bars you nudge by can be set in the NUDGE SET page.

LOCATE functions also change slightly when MIDI B/B/C is selected in that you may go to a specific bar/beat as well as to time and/or a locate memory.

You will also note that the PLAY TO and FROM work in bars and beats (the exact amount may be set by pressing SHIFT+PREROLL)

PRE-ROLL and CYCLE PRE-ROLL are also expressed in bars when MIDI B/B/C is selected as the time display.

The system can store up to 10 tempo maps in memory. These are associated with any given project and are saved to disk with the project (typically, you will probably only ever make use of SONG 01 as the tempo map for your project). A tempo map can have up to 200 tempo changes and up to 20 time signature changes.

Tempo maps may be named (up to 6 characters³) in the usual way.

3 This is to maintain compatibility with the Akai DR8 which can only use a 6 character name.

CREATING A MIDI TEMPO MAP

To create a tempo map, use SONG 01 as the starting point. You will see that there is a tempo and t.sig (time signature) entry at the start of the song. These determine the map's starting tempo and cannot be deleted. You may edit them, however, to something more suitable simply by moving the cursor to the VALUE field and entering the tempo and time signature as appropriate.

The first thing you should do when creating a tempo map is identify the start of the song and reset the start time so that the song starts at bar 1, beat 1, clock 1 (this may be before or after a count in as you wish). Locate to the start of the song and carefully jog over it until you have the exact start point. Now press RESET START in the TEMPO MAP page. You will see this prompt:

```
Press EXECUTE to Reset Song Start Time
```

Press EXECUTE to set the song start, EXIT to cancel. All tempo changes and/or time signature changes you enter into the map will now be referenced to that song start point. Failure to mark the song start correctly will mean that tempo changes and time signature changes will not appear at the right point and so may cause sync problems with your sequencer.

After that, to build more steps into the map, first play/spool/jog/whatever to the point where you want the first change to be and press the ADD key (F3) - this will show this prompt:

```
Add step to song map? TEMPO T.SIG
```

You should respond accordingly, press F5 to add a tempo change or F6 to add a time signature change. Pressing F5 will show this prompt:

```
Press EXECUTE to add new Tempo
```

You may abort this by pressing EXIT.

Pressing F6 will show this prompt:

```
Press EXECUTE to add T.Sig at Bar 3
```

Again, press EXIT to abort.

NOTE: Because time signature changes can only occur at the start of a bar, adding a t.sig step will place it at the nearest bar boundary.

The cursor will automatically be placed on the step you have just created and you may edit it's value (the default step value for tempo is 120.0 BPM and for t.sig it is 4/4 - these should be edited as appropriate).

When you add tempo changes and or time signature changes to your map, you will note that these are shown on the 'locate bar' of the GRID:

```
T B
```

A 'T' is shown to indicate the position of a tempo change and a 'B' (beat) is shown to indicate the position of a change in time signature.

NOTE: When you are zoomed in vertically on the GRID, when you add a t.sig step, you may not see the 'B' appear. This will be because the bar boundary is off the screen. When you zoom out, you will see it.

Continue adding tempo changes and new time signatures as you need through the project.

You will note that as you add steps to the tempo map, once you exceed four steps, two up and down arrows will appear to indicate that there are steps 'above' and 'below' the screen:

Step	Type	Value	Time	
4	T. Sig	4/4	032:01:00	↑
5	Tempo	120.0 BPM	032:01:00	
6	Tempo	119.0 BPM	034:01:00	
7	Tempo	121.0 BPM	046:01:00	↓

RESET START ADD LOCATE DELETE

Use the cursor UP/DOWN keys to scroll through your tempo map.

DELETING TEMPO MAP STEPS

If you make a mistake or wish to delete any steps in the map, move the cursor to the step you wish to erase and press F6 - DELETE. As a precaution against accidentally deleting steps, you will receive this prompt:

```
Press EXECUTE to delete step
```

Press EXECUTE to delete the selected step or EXIT to abort.

LOCATING TO STEPS

You may use LOCATE - F4 - to go directly to steps in the tempo map. Simply move the cursor to the step you wish to locate to and press LOCATE followed by EXECUTE (EXIT to abort, of course).

Once you have constructed a tempo map, it will be automatically saved with the current project if AUTOSAVE is enabled, or you can save it manually by saving the project using the SAVE function in the usual way.

SYSTEM SETUP

MORE SETUP FUNCTIONS

Back on the main MULTI MACHINE SETUP page, pressing the MORE (F6) key will take you to a second page of options:



SAVE SETTINGS

Pressing SAVE (F1) on the second MULTI SETUP page will take you to the SAVE SYSTEM SETTINGS page:



As the screen informs you, the system will power up according to the settings you save now. If you wish, you may also reset the system settings to the default settings contained in the operating system by pressing ROM DEFAULT (F5/F6).

There are two kinds of settings stored in the system. The first are machine settings relating to the current setup of each machine in the system. For example, tracks selected for playback, editing and/or record, the sample rate, external timecode selection, input routing, etc.. These settings are stored in the flash memory of each individual machine connected to the system.

The second group of settings relate to the configuration of the RE32 itself. For example, the track zoom selection, LCD contrast and VGA display options. These settings are stored in the flash memory of the RE32 itself.

Pressing EXECUTE will save all settings parameters in the system (including each machine's own settings as well as those for the RE32). Pressing RE32 ONLY (F1/F2) will save just the local settings relating to the RE32.

LOAD SETTINGS

Pressing LOAD (F2) on the second MULTI SETUP page takes you to the LOAD SYSTEM SETTINGS page:

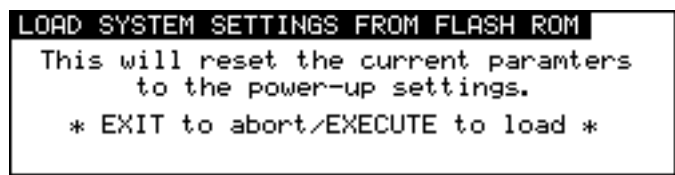

Pressing EXECUTE will replace the current system settings with those stored in the flash ROM of each device, effectively returning the system to its power-up state.

INFO

Pressing INFO(F2) on the second MULTI SETUP page will take you to the following page which displays information about devices connected to the system:

```
SYSTEM INFO           Machine : MULTI
RE32 O/S Version : 0.04d
RE32 Node ID : 0020C7800402
```

This page displays the Operating system version and Ethernet address of the selected machine. These parameters are for information only and cannot be changed from here.

The MACHINE parameter allows information to be displayed for each device in the system.

Press EXIT to return to the main SETUP page.

SYSTEM SETUP

SETUP - SINGLE MACHINE

The MULTI MACHINE SETUP pages allow the system to be configured quickly and easily for many applications. However, for more complex configurations, it may be necessary to setup certain parameters on individual machine. SINGLE MACHINE SETUP allows this individual parameter settings to be accessed.

When a single machine is selected on the SETUP page, the following options will be shown:



DIGITAL SETTINGS

Pressing DIGI (F1) on the SINGLE MACHINE SETUP page will take you to the following page:

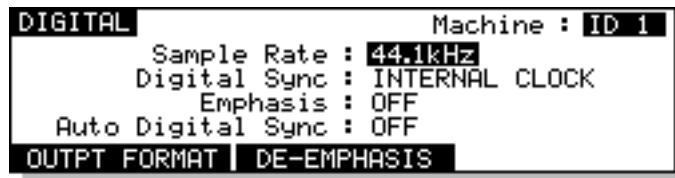

The parameters are:

- | | |
|-------------|---|
| MACHINE | This allows you to select which machine in the system you are configuring. |
| SAMPLE RATE | This sets the machine's sample rate. You may select 32kHz, 44.056kHz, 44.1kHz and 48kHz. Other options may be available depending on the facilities available on the selected machines. |

NOTE : Recordings made at a sample rate other than the selected sample rate will play back at the wrong speed. For example, if the sample rate is set to 44.1kHz and you try to play back a recording made at 48kHz, the recording will play back slow. Therefore, please make sure that your recordings are made at the correct sampling rate. Recordings made at different sample rates cannot be used in the same project.

DIGITAL SYNC	This allows you to synchronise the selected machine to a variety of video and wordclock synchronisation sources for precise system synchronisation. The options available (depending on the capabilities of the selected machine) are:
INTERNAL CLOCK	This selection uses the machine's internal crystal as its sync source and so the system is 'free running'. This is the selection used when using the machine on its own - when using it with external video equipment, to prevent drift of audio to picture, it is recommended to sync the entire system (i.e. VTR, all machines, etc.) to one of the external wordclock or video sync sources described below.
DIGITAL INPUT	<p>This synchronises the machine to the digital wordclock signal being received from the optional digital audio interface (TDIF, ADAT or AES/EBU).</p> <p>On the DD1500 there are two digital input sources which are displayed as:</p> <p>DIGI IN A - This synchronises the DD1500 to the digital wordclock signal being received through DIGITAL INPUT A. This selection is automatically made when recording when this input is used as the input source in the INPUTS routing matrix (see RECORDING).</p> <p>DIGI IN B - This synchronises the to the digital wordclock signal being received through DIGITAL INPUT B. This selection is automatically made when recording when this input is used as the input source in the INPUTS routing matrix (see RECORDING).</p>
<p>NOTE 1: <i>If optional DIO4 DIGITAL INPUTS are installed in the DD1500m, you will also receive DIGI IN C. in this field. When recording using digital inputs C - F, wordclock should always be received through DIGI IN A.</i></p> <p>NOTE 2: <i>When recording through multiple digital inputs, these signals MUST ALL BE AT THE SAME SAMPLING FREQUENCY .</i></p>	
PAL/SECAM Video	This synchronises the machine to a video sync signal through the SYNC BNC connector on the rear panel. Typically, this will be used in Europe to sync to a common PAL/SECAM house sync source.
NTSC 29.97Hz Video	This synchronises the machine to an NTSC 29.97Hz house sync signal through the SYNC BNC connector. This would normally be used in Japan or America when 29.97 frames per second timecode is being used.
NTSC 30Hz Video	This synchronises the machine to an NTSC 30Hz house sync signal through the SYNC BNC connector. This would usually be used in Japan or America when 30 frames per second timecode is being used.
PAL/SECAM (VITC in)	This option is available on the DD1500 only and synchronises the machine to a video sync signal through the VITC SYNC BNC connection. Typically, this will be used in Europe to sync to a common PAL/SECAM house sync source.

SYSTEM SETUP

NTSC 29.97Hz (VITC in) This option is available on the DD1500 only and synchronises the machine to an NTSC 29.97Hz house sync signal through the VITC SYNC BNC connection. This would normally be used in Japan or America when 29.97 frames per second timecode is being used.

NTSC 30Hz (VITC in) This option is available on the DD1500 only and synchronises the machine to an NTSC 30Hz house sync signal through the VITC SYNC BNC connection. This would normally be used in Japan or America when 30 frames per second timecode is being used.

WORDCLOCK On the DD8 or DR16pro, this allows you to sync the machine to a wordclock signal through the SYNC BNC connector.

On the DD1500, this option allows you to sync to a wordclock signal through the WORDCK (A) BNC connection.

This is used with a Sony PCM1630, etc. that has a separate SDIF wordclock output.

NOTE 1: *If a wordclock sync source is selected and is being successfully received, the W/C RCV LED above the RE32's timecode display will illuminate. If this LED flashes, this indicates that there is some kind of problem with the wordclock (i.e. it is not connected or the cable is faulty, whatever). Please check your connections.*

NOTE 2: *Recordings made at a sample rate other than the rate of the external wordclock source will play back at the wrong speed. For example, if the wordclock being received is 44.1kHz and you try to play back a recording made at 48kHz, the recording will play back slow. Please make sure that you are receiving the correct wordclock rate.*

AUTO DIGITAL SYNC If this field is ON, the DIGITAL SYNC automatically switches to the selected Digital input when tracks are enabled for recording.

OFF is for use with Yamaha 02R and other digital mixing desks when the selected machine is being used as the clock source for the desk. In this case, the machine should not switch to digital sync when a digital input from the desk is enabled, to prevent a sample-clock loop.

EMPHASIS This selects if the emphasis flag will be set on the digital outputs, and also controls the de-emphasis filter on the DA option board.

DIGITAL OUTPUT FORMAT

If the selected machine has any digital audio interface options fitted, pressing the OUTPUT FORMAT key (F1/F2) on the DIGITAL SETTINGS page will give you this screen:

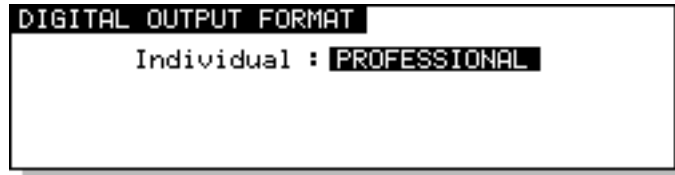

In this page, you may set the output format for the digital audio outputs. The INDIVIDUAL field allows you to set the format for the individual digital outputs and you may choose PROFESSIONAL or CONSUMER. PROFESSIONAL would be the choice to make when interfacing with AES/EBU digital audio equipment whilst CONSUMER would be the choice when connecting to DAT machines that use the SPDIF format of digital inputs.

NOTE: *There is no equivalent page for the digital inputs because the machine's digital audio receivers can automatically detect the format and adjust accordingly.*

OUTPUT DE-EMPHASIS

The DE-EMPHASIS softkey (F3/F4) will display this screen:

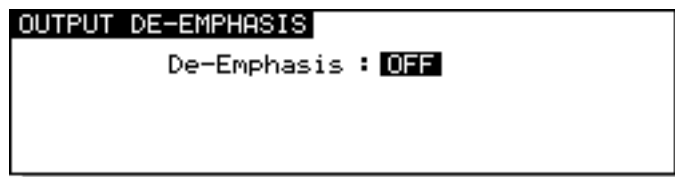

Here, you may switch de-emphasis on or off for any of the outputs.

Some digital recordings have pre-emphasis applied to them. These recordings have a slight HF boost which needs to be cut (de-emphasised) during playback. This page allows you to switch de-emphasis on or off as appropriate.

NOTE: *If you are using a mixture of 'normal' digital recordings and pre-emphasised recordings, please note that if any of the outputs have de-emphasis applied, 'normal' recordings will sound a bit dull - this is because de-emphasis (i.e. HF cut) is being applied to all recordings. The pre-emphasised recording will playback correctly. If, however, you leave de-emphasis off, the 'normal' recording will playback properly but the pre-emphasised recordings will sound a bit bright.*

SYNC SETTINGS

Pressing SYNC (F2) on the SINGLE MACHINE SETUP page will take you to the following page:

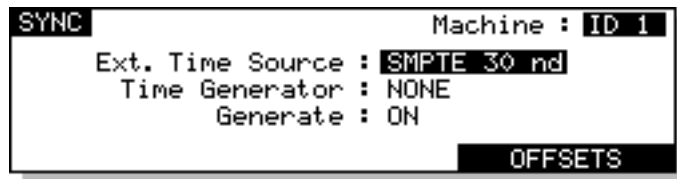

The parameters on the page are:

EXT. TIME SOURCE Here, you may choose the type of external timecode synchronisation you are using and works in conjunction with the ON-LINE key on the RE32. When the ON-LINE key is not switched on, the system is 'free running'. With the ON-LINE key switched on, the system will not playback or record unless the timecode type selected here is received. The selections in this field are:

SMPTE 24 fps - This selects that the selected machine will synchronise to timecode running at 24 frames per second. This would be a typical selection to make when synchronising to film equipment.

EBU 25 fps - This selects that the selected machine will synchronise to timecode running at 25 frames per second. This would normally be selected when sync'ing to EBU timecode in Europe.

SMPTE 29.97 nd - This selects that the selected machine will synchronise to non-drop timecode running at 29.97 frames per second. This would typically be used in America and Japan when working with NTSC colour.

SMPTE 29.97 drop - This will synchronise the selected machine to 29.97 drop timecode - NTSC colour. This would normally be used in America or Japan.

SMPTE 30 nd - This selects that the selected machine will synchronise to non-drop timecode running at 30 frames per second. This is the standard for NTSC black and white television and would typically be used in America, Canada and Japan. Many American and Japanese music studios use this frame rate.

SMPTE 30d NTSC BW - This will synchronise the selected machine to 30 drop frame timecode. This is the standard for NTSC black and white television and would occasionally be used in America, Canada or Japan.

NOTE: *On many synchronisers and some pieces of video equipment, what they display as 30fps drop is actually 29.97fps drop. On the Akai DD/DR machines, 30d NTSC BW is actually 30 frames per second, dropping a frame every now and then and so runs a little under 1% faster than true 29.97fps drop. You should select 29.97 drop when working with NTSC colour in America, Japan or Canada. and 30 drop when working with black and white. 30d NTSC BW is unlikely to be used very often but please do not confuse Akai's 30 drop-frame with other equipment's which may actually be 29.97fps drop.*

VITC 25 fps - This selects that the selected machine will synchronise to VITC (Vertical Interval TimeCode) running at 25 frames per second. This would normally be selected when sync'ing to EBU VITC in Europe.

VITC 29.97 nd - This selects that the selected machine will synchronise to non-drop VITC running at 29.97 frames per second. This would typically be used in America and Japan when working with colour television.

VITC 29.97 drop - This will synchronise the selected machine to 29.97 drop VITC. This would normally be used in America or Japan when working with colour television.

VITC 30 non-drop - This selects that the selected machine will synchronise to VITC running at 30 frames per second. This would typically be used in America and Japan when working with NTSC black and white television.

VITC 30d NTSC BW - This will synchronise the selected machine to 30 drop VITC. This would normally be used in America or Japan when working with NTSC black and white television (see SMPTE 30d NTSC BW).

Biphase 24fps x 2 - This selects that the selected machine will sync to bi-phase at 24 frames per second with 2 cycles per frame. This is used when synchronising the DD1500 to film equipment.

Biphase 25fps x 2 - This selects that the selected machine will sync to bi-phase at 25 frames per second with 2 cycles per frame. This is used when synchronising the system to film equipment.

Biphase 24fps x 4 - This selects that the selected machine will sync to bi-phase at 24 frames per second with 2 cycles per frame. This is used when synchronising the system to film equipment.

Biphase 25fps x 4 - This selects that the selected machine will sync to bi-phase at 24 frames per second with 4 cycles per frame. This is used when synchronising the system to film equipment.

Biphase 24fps x 10 - This selects that the selected machine will sync to bi-phase at 24 frames per second with 10 cycles per frame. This is used when synchronising the system to film equipment.

Biphase 25fps x 10 - This selects that the selected machine will sync to bi-phase at 24 frames per second with 10 cycles per frame. This is used when synchronising the system to film equipment.

EBU 25fps (+4%) - This special selection should be made when working with video material that has been derived from a frame-by-frame transfer from 24 fps film to 25 fps video. When material is transferred in this way, the visuals will actually run 4.1% faster when played from the video. As a result, the system needs to playback audio with the same speed offset in order to maintain sync.

This selection should be used when working with material that has been transferred from film in this way. Whilst working with the video, the audio will play back slightly faster and may sound unnatural but this is not a problem as, ultimately, the audio will be played back synced to the master film at 24fps at which point, correct playback speed will be restored.

NOTE 1: *It is not possible to record audio when synchronised to this selection.*

NOTE 2: *You must select 25fps (+4.1%) as the time display style - see below.*

SMPTE/EBU+RS422 - These options are available at all frame rates and are for use with RS422 equipped VTRs when the selected machine is acting as an RS422 master controller (i.e. when all playback, locating, jogging, etc., of both the selected machine and VTR are controlled from the RE32). SMPTE/EBU from the VTR is still connected as usual via the EXT. TIME input and the ON-LINE key must be switched on. The selected machine will receive timecode information in playback from the LTC connection but, when working in slow motion, it receives timecode over RS422 making locking of the two machines tighter.

NOTE: *The SMPTE+RS422 selection described above MUST be used when using the selected machine as an RS422 master.*

SMPTE/EBU+VITC - These options are available on the DD1500 only (at all frame rates) and allow the DD1500 to follow SMPTE/EBU timecode as normal during playback but, during extremely slow motion playback or jogging, the DD1500 automatically switches to VITC for better slow motion lock between the machines. Naturally, both the LTC and VITC inputs must be used when this timecode selection is made.

NOTE: *When the DD1500 switches to VITC at very, very slow jog speeds, you will not hear audio as you jog but you will notice improvements in the accuracy of frame locking at such slow speeds.*

RS422 - It is also possible to synchronise the selected machine to timecode over RS422 only and all frame rates are supported. However, you will note that this is primarily of use when using the system with a non-linear video recorder (see the section that explains the RS422 functions for more details on this).

- TIME GENERATOR** Here you may select the type of timecode the selected machine will generate. The options are:
- RE-GENERATE SMPTE** - This option is available on the DD1500 only and will re-generate fresh, electronic SMPTE/EBU timecode at whatever rate is being received. You may find this useful for re-stripping a tape where the source material has dropouts.
- SMPTE/EBU selection** - These will generate timecode at the selected frame rate regardless of what the EXT. TIME source is.
- BI-PHASE selection** - All of the bi-phase selections will generate bi-phase at its select frame rate and cycle rate regardless of what is EXT. TIME source is.
- MTC** - These selections will generate MIDI Timecode at all frame rates through the rear panel MIDI OUT. This should be used when synchronising a MIDI sequencer to the system.
- MIDI SPP** - This will generate MIDI Clock with Song Position Pointer through the MIDI OUT. This may also be used for synchronising MIDI sequencers.

NOTE: *The Akai DD/DR Series machines can read one type of timecode and generate another. For example, they can receive SMPTE/EBU timecode at one rate and generate it at a different rate. It can also receive SMPTE/EBU and generate Bi-Phase at any of the rates available (or vice versa). Likewise, a machine could be receiving SMPTE/EBU whilst simultaneously generating MTC or MIDI Clock. In this way, any machine can be used as a very comprehensive timecode converter to help you overcome many of the awkward situations one can be faced with when receiving work done at different (or the wrong!) timecode rate.*

- GENERATE** This selects when the system will generate the timecode selected above. The options are:
- OFF** - The selected machine will not generate the selected timecode shown in the TIMECODE TYPE field. This may be useful to switch external equipment 'off-line'.
- ON** - The selected machine is always generating the selected timecode when playing, recording, fast forwarding, rewinding, jogging and spooling.
- VIA ON-LINE KEY** - This allows you to switch timecode generation on or off using the ON-LINE key. When this is selected, with the ON-LINE key ON, the selected machine will generate the selected timecode type and when ON-LINE is off, the selected machine will not generate timecode. This may be useful when the system is a slave to an external device but is also passing on timecode to other equipment. You can use the ON-LINE key to totally isolate the system so that it can be used on its own.
- External Control** - This allows you to switch timecode generation on or off using the appropriate key on the front panel of the selected machine.

SYSTEM SETUP

RECORD SETUP

Pressing RECORD (F3) on the SINGLE MACHINE SETUP page will take you to the following page:

```
RECORD SETUP           Machine : ID 1
  Crossfade : 23 milliseconds
  Auto-monitor : RECORD ONLY
  Record Mode : DESTRUCTIVE
  Punch Mode : NORMAL
                                     ROUTE INPUTS
```

This page is very similar to the RECORD SETUP page described earlier in the section on recording and includes all the same parameters. Additionally, it provides direct access to the ROUTE INPUTS page for the selected machine.

OPERATING LEVELS

The DD8 includes a software controlled adjustment for the operating levels of its A/D and D/A converters. When a DD8 is selected, pressing LEVELS (F4) on the SINGLE MACHINE SETUP page will take you to the following page:

```
OPERATING LEVEL           Machine : ID 1
  Reference Level : -18 dB
```

The parameters on this page are:

MACHINE This allows you to select which machine in the system you are configuring.

REFERENCE LEVEL The Reference Level is used to set the 0 VU of the A/D and D/A converters.

Available selections are -12 dB , -16 dB, -18 dB and -20 dB.

If a machine that does not have support for this function is selected, you will see the following message:

```
OPERATING LEVEL           Machine : ID 1
  The operating level can not be changed
  on the selected machine
```

REMOTE PAGES

Pressing REMOTE (F5) on the SINGLE MACHINE SETUP page will take you to the following page:



This page is used to setup a variety of options relating to external control of the selected machine. The available options are shown on the soft keys and will vary depending on the interfaces fitted in the selected machine.

The MACHINE parameter, as on other SETUP pages, allows you to select which machine in the system you are configuring.

Pressing the AKNET key takes you to a page which shows the Ethernet ID number assigned to the selected machine. This number is programmed during production:

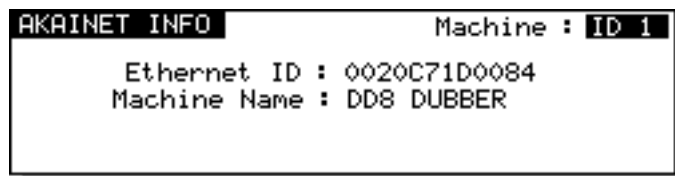

Pressing the MIDI key takes you to the following page:



This allows you to setup the selected machine as a SLAVE for MIDI MACHINE CONTROL.

Pressing the RS422 key takes you to the RS422 MACHINE CONTROL setup pages described in a separate section.

SYSTEM SETUP

GPIO SETUP

Some machines may be fitted with an interface that offers several GPIs (General Purpose Inputs) and GPOs (General Purpose Outputs) that may be used for a variety of purposes. For example, the GPIs may be used for track arming control from an external mixing console with the GPOs providing track status tallies.

If the selected machine is a DD8 or DR16pro that has this option available pressing the GPIO key on the REMOTE page will take you to the GPIO SETUP page:



This screen allows you to configure the GPIO board in MAG or MULTITRACK modes.

The parameters on this page are:

MODE In MAG mode, the GPIs assigned for track selections are momentary (they are triggered by a pulse).

In MULTITRACK mode, the GPIs assigned for track selections are level triggered. (they are held at one level to select a track and at the other level to deselect it).

PUNCH IN This parameter is only shown when MULTITRACK mode is selected and is used to select how the machine will start recording.

The available options are:

REC + PLAY The machine will start recording when both GPI 'RECORD' and 'PLAY' commands are activated at the same time.

REC ONLY The machine will start recording when a GPI 'RECORD' command is received on its own.

TRACK COMMANDS With this option, the machine will behave as if it is in MAG mode, but track selections will be level triggered. Record track commands will only be accepted while the transport is in motion. When the transport motion stops, all record track selections are cleared.

Pressing ASSIGN (F6) will take you to the GPI assignment page.

If the selected machine is a DD1500, the above parameters do not apply and pressing the GPIO key on the REMOTE page will take you directly to the GPI assignment page:

GPI SETUP	Active	Function
GPI 1	OFF	PLAY
GPI 2	OFF	PLAY
GPI 3	OFF	PLAY
GPI 4	LOW	RECORD

GPI SETUP

NOTE: When the selected machine is a DD1500m, only 3 GPIs will be shown.

This screen allows you to set parameters relating to the GPIs. The parameters are:

ACTIVE You may select OFF, HIGH and LOW. When OFF, the GPI has no function. When set to HIGH, the selected function (see below) will become active when a +5V signal is received at the GP input. When set to LOW, the selected function will become active when a 0V signal is received.

FUNCTION Here you may assign a range of DD8 functions to the GPIs. These include:

PLAY - When a pulse is received, playback will start.

STOP - When a pulse is received, playback will stop.

FAST FORWARD - When a pulse is received, the DD will fast forward.

REWIND - When a pulse is received, the DD will rewind.

RECORD - When a pulse is received, the DD will start recording.

PLAY TO - When a pulse is received, the DD will play to the current NOW time.

PLAY OVER - When a pulse is received, the DD will play over the current NOW time.

PLAY FROM - When a pulse is received, the DD will play from the current NOW time.

PLAY IN TO OUT - When a pulse is received, the DD will play from the selected IN point to the selected OUT point.

PLAY LAST - When a pulse is received, the DD will play the last thing played.

PLAY BACKWARDS - When a pulse is received, the DD will play in reverse.

GRAB IN MARK - When a pulse is received, it will mark an IN point.

GRAB SYNC MARK - When a pulse is received, it will mark a SYNC point.

SYSTEM SETUP

GRAB OUT MARK - When a pulse is received, it will mark an OUT point.

RESET BIPHASE - This will reset the biphase receiver.

TOGGLE EXT.TIME - When a pulse is received, it will switch on/off the external time source.

RECORD REHEARSE - This will switch on/off the record rehearsal function.

PLAY TRACK - These options allow any of the playback tracks to be switched on/off by a GPI control. The first GPI command will switch the track on, the next will switch it off.

RECORD TRACK - These options allow any of the record tracks to be switched on/off by a GPI control. The first GPI command will switch the track on, the next will switch it off.

RECORD TRACK ON - These options allow any of the record tracks to be switched on by a GPI control.

RECORD TRACK OFF - These options allow any of the record tracks to be switched off by a GPI control.

Pressing the GPO soft key (F1) will take you to the GPO assignment page:

GPO SETUP	Active	Function
GPO 1	OFF	RECORD TRACK 1
GPO 2	OFF	RECORD TRACK 1
GPO 3	LOW	RECORD TRACK 1
GPO 4	LOW	RECORD TRACK 1

GPI SETUP

This page allows you to set the parameters for the General Purpose Outputs (GPOs). The parameters are:

ACTIVE Allows you to select OFF, HIGH or LOW. OFF switches the GPO function off. HIGH selects that the GPO is normally low (0V) and when the selected function is activated, the output will be pulled up to the voltage at the GPO pullup pin. When set to LOW, the GPO is pulled to 0V when the selected function is activated.

FUNCTION A variety of functions may be applied to the GPOs. These are:

PLAYING - The GPO will change level when PLAY is activated.

STOPPED - The GPO will change level when STOP is activated.

LOCATING - The GPO will change level while locating to a timecode position.

RECORDING - The GPO will change level when RECORD is activated.

EXT TIMECODE OK - The GPO will change level while external timecode is being successfully received.

EXT WORDCLOCK OK - The GPO will change level while external wordclock is being successfully received.

EXT TIME LOCK - The GPO will indicate when the transport is successfully locked to external timecode.

REC TRACK - These options allow a tally to be sent when any of the record tracks are switched on/off.

REHEARSE - These options allow a tally to be sent when rehearse mode is enabled.

TRACK SLIP 1 ..8 - These options allow an appropriate tally to be generated when a track is slipped.

USER KEYS

USER KEYS allows the function of key presses on the RE32 to be redefined. The alternate key definitions are active while the USER KEY is switched on. In multi-machine setups, USER KEYS also allows commands to be send to the currently selected machine, all connected machines or any single machine. The alternate key definitions are active while the USER KEY is switched on.

Pressing SHIFT+USERKEYS now displays this screen:

USER KEYS SETUP	Function	Machine
SHIFT+IN	Store IN	Multi
SHIFT+OUT	Store OUT	Multi
RECORD	Rec (Toggle)	1
NEW KEY		DELETE KEY

In the default state, no USER KEYS are defined. To define a key, press NEW KEY. You will see this prompt:

```
Press Required keys(s) or press EXIT..
```

Press the key you wish to redefine. This can either be a single key, or a combination of SHIFT plus another key. The names of the key(s) you select will be displayed in the list on the left hand side of the screen. On the right hand side of the screen, you can select the function you wish to assign to this key press.

The options available include:

STORE IN	Mark IN time
STORE OUT	Mark OUT time
STORE SYNC	Mark SYNC time
EXT.TIME	Switch EXT.TIME on/off
REHEARSE	Switch REHEARSE on/off
AUTO-PUNCH	Switch AUTO-PUNCH on/off
ALL REC TRKS	Enable all record tracks
CLR REC TRKS	Disable all record tracks
REC TRACK 1	Switch selected record track on/off
:	
REC TRACK n	
EDIT TRACK 1	Switch selected edit track on/off
:	
EDIT TRACK n	
ALL PLAY TRKS	Enable all play tracks
CLR PLAY TRKS	Disable all play tracks

PLAY TRACK 1	Switch selected playback track on/off
:	
PLAY TRACK n	
REWIND	Rewind transport
FAST FORWARD	Fast Forward transport
STOP	Stop transport
PLAY	Put transport into play
RECORD	Send record command when PLAY is also pressed
PLAY REVERSE	Play backwards
BPH RCV RESYNC	Resync biphase receiver
BPH GEN RESYNC	Resync biphase generator
COPY EDIT	Select copy edit page
CUT EDIT	Select cut edit page
ERASE EDIT	Select erase edit page.
PASTE EDIT	Select paste edit page
INSERT EDIT	Select insert edit page
SELECT MACHINE	Select machine
REC (PUNCH-IN)	Drop into record
REC (TOGGLE)	Drop in/out of record

The MACHINE field in the right hand column selects which machine the command will be sent to when USER KEYS are enabled. The options are:

MULTI	Send command to all connected machines
1 .. 16	Send command to specified machine only.

To remove a USER KEY definition, move the cursor over the item you wish to remove and press the DELETE KEY soft key.

RC15 CONNECTION

The RC15 is a small remote which connects to the EXPANSION port on the RE32. It has 8 functions keys, 6 transport keys and a jog/shuttle wheel which can be programmed in a similar way to the USER KEYS function described previously.

It may seem bizarre to offer a remote for a remote but the RC15 can be a useful addition to the RE32 in project studios where recording and track laying is a one-man operation. The RC15 can be used in, say, a vocal booth or separate, isolated studio area or could be conveniently located by your keyboard and/or sequencer for punching in and out of recordings and overdubs away from the RE32. Its eight function keys are completely programmable to do whatever you want and can be set using the RC15 SETUP page.

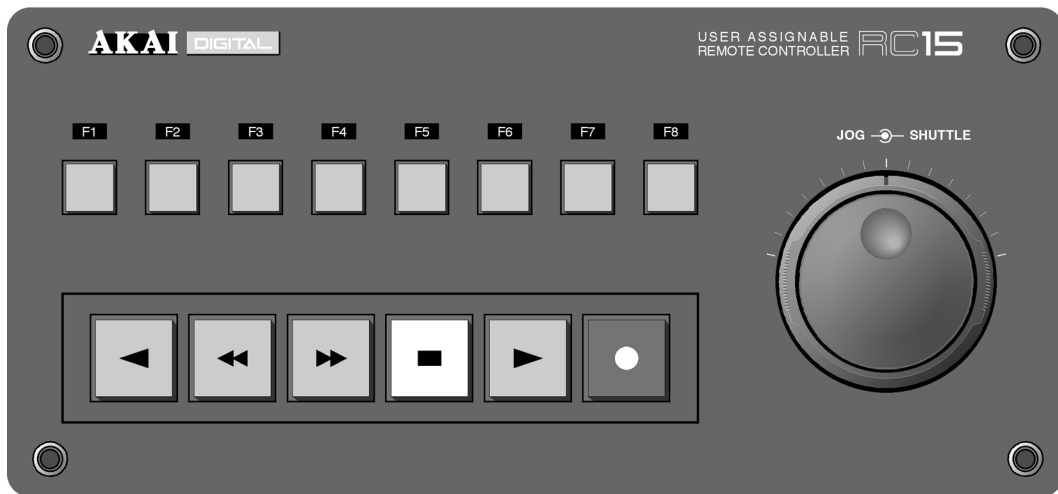

When the RC15 is connected, an extra softkey will appear on the USER KEYS SETUP page accessed by pressing SHIFT+USER KEYS.

USER KEYS SETUP	Function	Machine
SHIFT+IN	Store IN	Multi
SHIFT+OUT	Store OUT	Multi
RECORD	Rec (Toggle)	1
NEW KEY	RC15 SETUP	DELETE KEY

Pressing the RC15 SETUP softkey will take you to the following screen:

RC15 KEY SETUP	Function	Machine
F1	Rec Track 1	1
F2	Rec Track 2	1
F3	Rec Track 3	1
F4	Rec Track 4	1
USER KEYS		

The RC15 keys are listed in the column on the left hand side of the screen. The 8 function keys are listed as F1-F8, and the transport keys are listed as TRANSPORT 1-TRANSPORT 6. As on the USER KEY SETUP page, you can select a function for each key and also select if the command is sent to all machines or any specific machine.

SYNCING TO EXTERNAL TIMECODE

There is nothing very special to do for this. Assuming a suitable timecode source is connected to the first machine in the system (e.g. SMPTE etc.), select the type of timecode you wish to sync to in the SYNC page using the EXT. TIME SOURCE field and switch the ON-LINE key on. With the ON-LINE key switched on, when you press PLAY on the RE32, nothing will happen until the system receives timecode from the external source.

When external timecode is being received successfully, the system will play synchronised to that timecode and the EXT T/C RCV LED above the RE32's timecode display will be steadily lit. If at any time, the EXT T/C RCV LED flickers, this indicates a problem with the external timecode such as dropout. The system will 'flywheel' for a short while in the event of timecode dropout but, if the dropout is too long, the system will stop playing.

NOTE: *When you switch on the ON-LINE key, PLAY is also engaged so that the system will automatically play whenever timecode is received and will stop when external timecode is stopped. However, if you specifically press the STOP key to stop playback, you will need to press PLAY again for it to follow external timecode.*

SETTING TIMECODE OFFSETS

Pressing OFFSETS (F5/F6) on the SYNC page will take you to the following page:

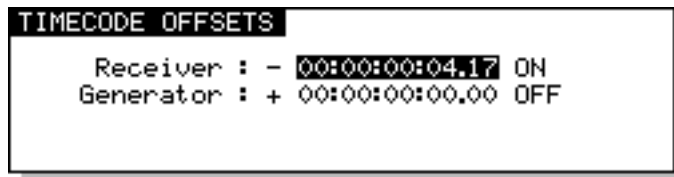

Sometimes, it is necessary to set an offset between the system and an external machine. For example, your project may start at 00:00:00:00 but your timecode source start at 10:00:00:00. Using this page, you may set offsets so that the two machines play in sync without you having to extensively modify the project's start time.

The parameters on this page are:

RECEIVER When the RECEIVER field is set to ON, the offset will be added to/subtracted from the incoming timecode so that the selected machine and external time are locked at the current absolute/relative time position.

When the RECEIVER field is set to OFF, the offset will not be added to/subtracted from the incoming timecode.

GENERATOR When the GENERATOR field is set to ON, the offset will be added to/subtracted from the output timecode.

When the GENERATOR field is set to OFF, no offset will be applied to the timecode output.

If the project starts at 00:00:00:00.0 but the incoming timecode starts at 1 hour, you should set a TIMECODE RECEIVE OFFSET of -01:00:00:00.0. This will subtract 1 hour from the incoming timecode, thereby effectively providing the system with timecode starting at 00:00:00:00.0. Conversely, if the project starts at, say, 10 hours but the incoming timecode starts at 1 hour, you would need to set +09:00:00:00.0 in the RECEIVER field, adding 9 hours to the incoming timecode so that it plays from 10 hours.

ADVANCED OFFSETS

Sometimes, it is necessary to set an offset between the Akai system and an external tape or VTR machine. For example, your project may start at 00:00:00:00 but the visuals start at 10:00:00:00.

Before we look at these functions, it must be said that some of the offset facilities provided on the RE32 are a bit specialised and apply only to certain applications. If you need these specialised functions, you will know what you want. However, if all you need to do is set an offset against incoming timecode, you can ignore much of this!

The main page of the RE32 (when the ALL SAFE key is switched on) includes several keys relating to timecode offsets:



Pressing the OFFSET key (F5/F6) gives this screen:

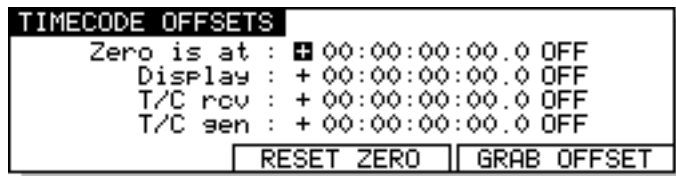

Here, you may set offsets so that the machines in the system play in sync with external devices without you having to extensively modify the project's start time. You may also set offsets for the timecode displays on the RE32 and external monitor as well as setting absolute and relative times.

The fields on this page are:

ZERO IS AT This sets a relative offset and allows the 00:00:00:00.0 reference time to be placed at a time other than absolute zero. For example:

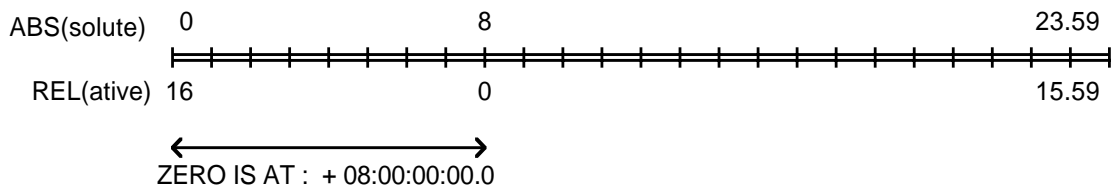

An Akai project can be likened to a 24 hour reel of tape and, using the REL(ative) setting, you can play across 'midnight'.

The soft keys ABS/REL (F1/F2) on the main PLAY page switch between absolute and relative time display.

ZERO (F3/F4) sets the current time as the ZERO point. This also has the effect of automatically switching ZERO IS AT (i.e. the REL) time display to ON. You may select ABS(olute) or REL(ative) more conveniently using the soft keys F1 or F2 (ABS or REL) if you wish. You will note that as you switch the ZERO IS AT field on or off the ABS/REL keys highlight to indicate selection.

NOTE 1: *You may find it useful when starting a project from scratch to always start at, say, 1 hour and use the relative time display so that the project effectively still starts at zero. In this way, if you suddenly find you need to add cues before 00:00:00:00, you can. If you use absolute and start at zero, you will first have to slip all cues in the project forward to accommodate the new cues.*

DISPLAY	<p>This offset is added to relative time before it is displayed. The options are OFF, ON, LED ONLY.</p> <p>OFF and ON should be fairly self-explanatory. LED ONLY applies the offset to the LED timecode display on the RE32's panel only - the timecode display on the external monitor does not show this offset. This is a special requirement for in situations where film and SMPTE/EBU equipment is being used together. In this case SMPTE/EBU timecode can be displayed on the RE32's LED timecode display and zero-based feet/frames display can be displayed on the VGA monitor's timecode display (for example, the first frame of the film is at a SMPTE/EBU time of 10 hours but, as no film footage has elapsed, the feet/frames display on the external monitor shows 0000 feet/00 frames).</p>
T/C RCV	<p>This is an abbreviation of TIMECODE RECEIVE OFFSET and sets an offset that is applied to incoming timecode.</p>
T/C GEN	<p>This is an abbreviation of TIMECODE GENERATE OFFSET. This offset is applied to generated timecode.</p>

RS422 MASTER CONTROL

Any of the Akai DD/DR series machines can be used as an RS422 master using the Sony™ P2 protocol. This means that all play, jog, shuttle and locate commands are issued from the Akai machine allowing you to control a VTR equipped with RS422. Connections should be made as shown in the RS422 section of each machine's manual.

Switching on the ON-LINE key engages the RS422 function. Because it is necessary for the external VTR to 'report back' its timecode position to the system via the SMPTE IN and EXT. TIME key, when you switch the ON-LINE key on, the EXT. TIME source is automatically enabled to ensure correct lock up of both the Akai machine and the VTR.

However, because of the frame accuracy limit imposed on the Akai machine by the VTR over RS422, it is sometimes necessary to 'isolate' the Akai system for greater editing accuracy, To do this, simply switch off the ON-LINE key - this will allow the system to be used 'stand alone'.

As a practical example, let's say you are trying to sync a door slam sound effect in the system's project with the picture on video. You could, of course, do everything referenced to frame accurate picture but, you just cannot get the door slam precisely in sync. By switching off the ON-LINE key, you can momentarily disengage the VTR, 'isolating' the system and you can place the sound effect, nudging it backwards or forwards in sub-frame increments on the RE32 until you think it's at the right position. You can then re-engage the VTR by switching on the ON-LINE key again and trying it out against picture. You can repeat this process until it's perfectly in sync.

The RS422 SETUP parameters are accessed from the SETUP page's REMOTE menu:



Pressing the RS422 soft key on this page will take you to the following page:

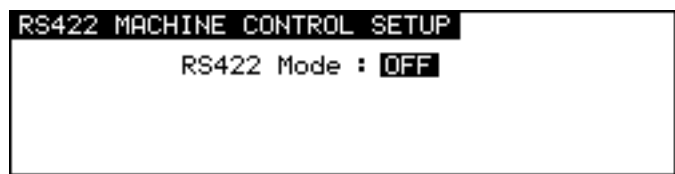

RS422 MASTER is selected in the RS422 MODE field. You will see this screen:



The parameters are:

EDIT DELAY This sets the delay between the edit instruction being issued and the machine responding to that command. Every machine is different (for example, a U-Matic is 6 frames and a Betacam is 2 or 3 frames - you should consult your VTR's or edit controller's operator's manual for information on this).

VTR LOCATE OFFSET Most VTRs require a certain amount of 'run up' time when synced to external equipment. This field sets that time. When a value is set here, locating to any position will automatically cause the system to locate to a point slightly earlier than actually specified. In the above example, if you locate to 1 minute, the Akai machine will actually locate to 55 seconds.

NOTE: YOU MUST SELECT ONE OF THE SMPTE/EBU+RS422 OPTIONS AT A FRAME RATE APPLICABLE TO YOUR AREA WHEN USING RS422 MASTER.

These options are available at all frame rates. SMPTE/EBU from the VTR is still connected as usual and the ON-LINE key must be switched on. The Akai machine will receive timecode information in playback from the LTC connection but, when working in slow motion, it receives timecode over RS422 making locking of the two machines tighter.

LAYBACK FUNCTION IN RS422 MASTER

LAYBACK is a process where you have material on the Akai system that you wish to 'master' onto a VTR or other such RS422 equipped machine (such as an RS422 DAT machine). For example, you may receive a video tape with just dialogue on it. This is sync-transferred to an Akai machine where it may be edited and tidied up if necessary and sound effects, music and other 'sweeteners' can be added using the Akai system's multi-track capabilities. Finally, the whole thing is transferred back to the VTR.

To use the LAYBACK function, press LAYBACK (F1/F2). You will see this screen:

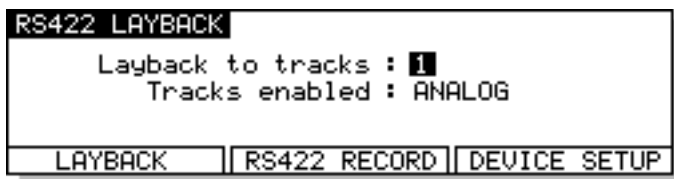

The parameters are:

LAYBACK TO TRACKS Here you may select which of the VTR's tracks the material will be recorded to. You may select VTR tracks 1, 2, 3, 4, 5, 6, 7, 8 (mono) or 1+2, 3+4, 5+6, 7+8 (stereo) or 1-4, 5-8 or 1-8.

TRACKS ENABLED Here you may select whether the layback (i.e. the mixdown) will be to the VTR's analogue tracks or its digital tracks. You may also select ANALOG+DIGITAL which will cause the layback to be recorded to both the analogue and the digital audio tracks of the VTR.

The soft key functions when LAYBACK key is pressed are:

PREROLL Pressing this key will cause the VTR to locate to the IN time minus the amount set in the VTR LOCATE OFFSET field (if this parameter is set to zero, then the default value of 5 seconds is used).

PREVIEW This allows you to 'rehearse' the layback (i.e. it will go into E-E mode at the IN point and will then stop at the OUT point). This function allows you to check whether the edit will be successful or not.

LAYBACK Pressing this will initiate the layback process (i.e. the VTR will play to the IN point and will drop into record on the VTR. When the OUT point is reached, it will stop).

NOTE: If tracks are accidentally enabled for record on the Akai system, they will be ignored when using the LAYBACK function.

USING THE LAYBACK FUNCTION

The RE32's IN and OUT markers set the record in/out points for the VTR. Assuming the functions described above are set as appropriate, you must first press PREROLL⁴. You then press LAYBACK and the VTR will drop in/out of record at the IN/OUT points marked.

You may 'build' the final transfer in sections (in this way, you can obtain the optimum mix section-by-section) and set IN/OUT points as appropriate. You may rehearse the drop in/out using PREVIEW and, when you're happy with the results, press LAYBACK to actually 'commit' the recording (in both instances, you must use PREROLL to locate to a time a bit before the IN point).

It may be that you want to transfer the whole project back to the video tape in one go. In this case, set the IN at the start of the project and the OUT at the end of the project and press LAYBACK (F1/F2) to transfer the whole project back to the master video tape in one pass.

Another use of this may be to receive a video tape as described above but the 'sweetened' version on the Akai system may be laid back to an RS422 equipped DAT machine thus preserving the dialogue on the original video with a synchronised 'master' on DAT.

4 The layback function will not work if the machine(s) are not located to a point before the IN time. The layback function requires that there be some form of pre-roll.

RS422 MASTER CONTROL OF NON-LINEAR VIDEO RECORDERS

Using the 'RS422 only' external timecode selection, it is possible to take full advantage of non-linear hard disk video recorders such as the FED V-MOD 100.

When using any of the SMPTE+RS422 external timecode options, although locate/lock times in this case are virtually immediate, when jogging at slow speeds, there is no significant performance improvement over a VTR and the non-linear video recorder will 'stutter' frame by frame much like a normal VTR. However, using the 'RS422 only' selection, slow speed jogging is exceptionally smooth and very tightly locked to the Akai system's audio jogging and so is ideal for spotting audio to picture.

However, please note that because of inaccuracies in the timecode sent via RS422, when playing at nominal speed, there may be instances where there is a ± 1 frame offset. This can be overcome by switching to SMPTE+RS422 for playback and using RS422 only for jogging and spotting. Of course, in the RS422 SETUP page, RS422 MODE must be set to MASTER and the ON-LINE key must be switched to ON.

SPECIFICATIONS

RE32 SPECIFICATIONS

Power Requirements	: 120V AC 60 Hz 19 W 220 - 240V AC 50Hz
Operating Temperature	: 5°C ~ 40°C
Operating Humidity	: 30% ~ 80% (without condensation)
Dimensions	: 483 x 86 x 310 (330 maximum) (W x H x D, mm) EIA 7U
Weight	: 5.6kg
Display	: 248 x 60 dot graphic LCD
Edit Resolution	: Sub-frame
Connectors	
Display Output	: 15-pin D-sub male, Analogue level VGA (640 x 480) IBM PC Format
Expansion Port	: 9-pin D-sub male, for RC15 (optional) connection
AKAINET	: BNC 50-ohms, for Ethernet (10 Base-2) connection
Keyboard Input	: 6-pin mini-DIN female, for PS/2 Keyboard connection
Accessories	: AKAINET Cable (BNC 50-ohms, 20m) x 1 AC Cord x 1 Operator's Manual x 1

※ Above specifications are subject to change without prior notice.

AUTO DIGITAL SYNC 156
AUTO PUNCH-IN/OUT 46
Auto-monitor 43, 145
AUTO-PUNCH key 46
AUTOLOCATOR 57
Automated Punch In/Out 59
AUTOSAVE 99

B

Backup 114
Backup Restore 121
Basic Editing Concepts 24
BASIC RECORDING 35
16-bit audio files 42
20-bit (packed) audio files 42
20-bit audio files 42
24-bit audio files 42

A

ADVANCED RECORDING 37
AIFF 41
AKAI audio files 41
AKAI Project 104, 138
AKAI->FAIRLIGHT 41
AKAI->FAIRLIGHT audio files 41
AKAINET 6, 9
AKAINET Termination 6, 7, 9
AKNET ID number 163
ALL SAFE 35
BIT LENGTH 42

C

Choosing a Monitor Screen 6
Cleanup Disk 133
Clearing locate markers 58
CLIPBOARD DISPLAY 13, 33
Copy (Disks/Files) 107
Copy (Multi-machine) 64
Copy (Single Machine) 72
Crossfade 43, 145
Crossfade Tools 95
CUE 3, 24
Cue Information 31
Cue Name Display 14
CURSOR KEYS 15
Curve (Edit Q) 92
Cut (Multi-machine) 69
Cut (Single Machine) 74
Cut Forwards (Single Machine) 75
CYCLE 59

D

DAT Archive 129
DAT Restore 132
DATA ENTRY KEYS 18
DATA ENTRY/NUDGE KEYS 18
DD8 Machine ID assignment 8
De-emphasis 157
Delete (Files) 111
Destructive record mode 37, 38, 39, 146
Digital Output Format 157
Digital recording 52
Digital Settings page 154

DIGITAL SYNC 155
Discard (Multi-machine) 68
Discard (Single Machine) 77
Disk Compatibility 136
Disk Directory 106
DISK INFO 105

D (cont)

DISK LABEL 29, 105
DISK UTILITIES pages 105
DISPLAY 6
Display Connection 6
DISPLAY STYLE 143
DR16pro Machine ID assignment 8

E

Edit Auto Zoom 32
EDIT CLIPBOARD 17, 71, 72, 74, 76, 78, 80, 82
Edit Cue/Q 91
EDIT KEY 61
EDIT PLAY KEYS 90
EDIT REGION 3, 24
EDITING 61
EMPHASIS 157
Erase (Multi-machine) 69
Erase (Single Machine) 76
Error Messages 34
EXECUTE 18, 61
EXECUTE - Completing Names 18
EXIT 18
EXIT - Abandoning Naming 18
EXPANSION CONNECTION 6
EXT T/C RCV LED 174
EXTERNAL TIMECODE 174, 175

F

Fade (Edit Q) 88
Fade Down (Edit Q) 88
Fade Up (Edit Q) 88
Fairlight 41
Fairlight Compatibility 139
FAST FORWARD 53
FAT 16 140
FILE TYPE 41
Formatting (Backup) 114
FORMATTING DISKS 28
FREE ON DISK 40

G

Getting around the GRID 21
GPIO Setup 164
GRAB function 21
Grabbing Times 58
GGraphical Interface Display 13
GRID 3, 13
Group Store/Recall 56

I

IN KEY 61
IN TIME 3, 61
IN to OUT length 61
IN->NOW 88
Info page 153

INPUT MON 55
 Input Routing 47
 INPUT ROUTING - DR16pro 48
 Insert (Multi-machine) 66
 Insert (Single Machine) 80
 Invalid Edit Region 61

J

JOG WHEEL 11, 19, 22
 JOG/SPOOL key 22
 JOG/SPOOL SET 22

K

KEYBOARD 6

L

LABEL field 105
 LAYBACK 176
 LCD 10
 LCD CONTRAST 144
 Level (Edit Q) 92
 LIBRARY 4
 Load (Project) 102
 Load (Settings) 152
 LOCATE 55
 LOCATE FUNCTION 21

M

Mac Compatibility 136
 Machine Box 33
 Machine ID assignments 8
 MAINS INPUT 6
 MARK POINT 3
 Meter Source 32
 Meters Setup 32
 MIDI Setup 167
 MIDI Tempo maps 150
 Minimise Disk 134
 Monitor Screen 6
 Move Region (Single Machine) 83
 MS-DOS Compatibility 140
 MULTI-MACHINE EDIT 64
 MULTI-MODE 4
 MUTING TRACKS 55

N

NAMING FILES 19
 New Project 104
 NEXT Q Key 21
 Non-Linear Video 178
 NOW TIME 3, 12, 33
 NOW TO END 93
 Nudge 84
 NUMERIC KEYPAD 17

O

OFFSET 144, 172, 173
 OMF 136
 On-Line Key 175, 178
 Operating Levels 162
 OUT KEY 61
 OUT TIME 3, 61
 Overlay (Multi-machine) 67
 Overlay (Single Machine) 82

P

PANEL LAYOUT 10
 Paste (Multi-machine) 66
 Paste (Single Machine) 79
 PC Keyboard 19
 Peak Hold 32
 PLAY FROM 54, 90
 PLAY IN>OUT 54, 90
 PLAY KEY 53
 PLAY TO 53, 90
 Power up screens 9

P (cont)

PRE-ROLL 59, 60
 PREV Q Key 21
 PROJECT 3
 PROJECT NAME 12
 PROMPTS 20
 ProTools Compatibility 136
 ProTools Import 137
 ProTools Session 104
 ProTools Sessions (creating...) 138
 Punch In/Out Automation 59
 PUNCH MODE 147
 Punch modes 44

R

RC15 Setup 170
 REC Key 53
 RECORD 35
 RECORD DISK 40
 RECORD MODE 37, 43, 145
 RECORD SETUP 43, 145, 162
 RECORD TYPE 41
 Recording digitally 52
 RECORDING NAME 37
 REDO 61
 REFERENCE LEVEL 162
 REHEARSE 46
 Remote Settings 163
 RENAMING FILES 20, 112
 Restoring a backup 121
 REVERSE PLAY 53
 REWIND 53
 Routing Inputs 47
 RS422 CONTROL (Layback) 176
 RS422 CONTROL (Master) 175
 RS422 Setup 163, 175
 Ruler 33

S

S-VGA Monitor 6
 SAMPLE RATE 142, 154
 Save (Project) 98
 Save (Settings) 152
 SCROLL BAR Display 58
 Scroll Direction 33
 Scroll View Keys 16
 SD-II 40
 SD-II audio files 40
 SELECT CUE/EDIT CUE 91
 SELECT Q 24
 SELECT Q KEY 62

SET FUNCTIONS 19
Setting Up 26
Setup (GPIO) 164
Setup (MIDI) 163
Setup (Multi Machine) 142
Setup (Record) 162
Setup (RS422) 163
Setup (Single Machine) 154
SHIFT 19
SHIFT key 10
SHIFT+JOG 22
SIGNAL GND 6
SINGLE MACHINE SETUP 154
SINGLE-MACHINE EDIT 70
SINGLE-MODE 4
SOFT KEYS 10, 18
SOLOING A TRACK 55
Sound Designer II 41

S (cont)

Speed page 148
Split (Multi-machine) 69
Split (Single Machine) 86
START TO NOW 93
Stereo Cue 63
STOP KEY 53
STORE 57, 58
STORE LOCATE 55
STORE NEXT 58
SYNC KEY 61
SYNC POINT 3, 61
Sync Settings page 158
SYSTEM SETUP 26, 141
SYSTEM STATUS 12

T

TC FRAME RATE 141
Tempo Maps 149
TERMINOLOGY 3
TIME GENERATOR 161
TIMECODE DISPLAY 10
Timecode Offsets 172, 173
TRACK METERS 12
TRACK MODE KEYS 10
TRACK SELECT KEYS 10
TRACK STATUS 12
TRACK ZOOM KEYS 16
TRACKS KEY 10
TRANSPORT KEYS 10, 21, 53

U

UNDO 19
UNDO KEY 61
USER KEYS 169
UTILITIES KEYS 10

V

VARISPEED 148
Verifying a Backup 120
VGA MONITOR LAYOUT 12
VGA SETUP 31

W

Waveform Magnification 16
Waveframe Compatibility 139
Write Protect 100
WRITE PROTECTED Prompt 30

X

XFADE key 96

Z

Zoom in/out 16