

LUXMAN

SQ507X

SOLID STATE STEREO INTEGRATED AMP. OPERATION MANUAL

THANK YOU FOR YOUR PATRONAGE ONTO LUXMAN SQ507X

The SQ507X is the newest transistorized pre-main amplifier with full advantages yielded by the very circuitry theoretically regarded as the best one under exhaustive study of LUX's engineering and designing.

The SQ507X is specially designed as an upgraded model of SQ505X based on the styling of the renowned SQ507 with the similar circuitry to that of SQ505X. The SQ507 has the output 50W x 50W (8 ohm both channels driven) against 30W x 30W of SQ505X.

Main amplifier section integrates full stage direct coupling circuit without output condensers by adoption of dual power supply system in order to procure sufficient damping factor and power character even to the extreme low end frequency. The output stage with pure complementary system completely eliminates cross-over distortion. The fore-stage adopts 2-stage differential amplifiers which ensure very stable performance eliminating the unpleasant shock-noise at switching the mains power.

Pre-amplifier section is equipped with 3-stage direct coupling circuit at equalizer stage. Combination of PNP-NPN-PNP transistors inherently superior in mains power utilization ensures the maximum linearity. The PHONO terminals are designed to have the withstand input voltage 300mV 1KHz in view of dynamic range of various programme sources. The silicon transistors of ultra low noise figure are adopted against noise characteristics throughout whole stages.

■ MAIN AMPLIFIER	
RMS POWER	50/50 watts (8Ω both channels driven) 60/60 watts (8Ω one channel driven)
THD	less than 0.04% (8Ω, 50W)
INTER MODULATION DISTORTION	less than 0.04% (8Ω, 50W)
POWER BANDWIDTH	5Hz -- 50,000Hz, -3dB, 0.04%
FREQUENCY RESPONSE	10Hz -- 60,000Hz, less than -1dB
INPUT CONNECTOR	SENSITIVITY: 560mv, IMPEDANCE: 50KΩ
DAMPING FACTOR	40(8Ω), 80(16Ω)
RESIDUAL NOISE	less than 1mV
■ PRE AMPLIFIER	
FREQUENCY RESPONSE	10 - 50,000Hz, -1dB (aux-1)
THD	less than 0.05% (aux-1, 1KHz, 1v)
INPUT SENSITIVITY	phono-1, phono-2: 2mv aux-1: more than 90mv, aux-2, aux-3: 90mv
INPUT IMPEDANCE	phono-1: 30K/50K/100KΩ (selectable) phono-2: 50KΩ aux-1: 50KΩ, aux-2, aux-3: 200KΩ
S/N RATIO	phono-1, phono-2: better than 63dB aux-1, aux-2, aux-3: better than 80dB
PERMISSIBLE INPUT VOLTAGE (Max.)	phono: 300mv,
TONE CONTROL	LUX TYPE NF turnover frequency selection Bass: defeat, 150, 300, 600Hz Treble: defeat, 6K, 3K, 1.5KHz Bass cut: 70Hz (-6dB/oct.) Treble cut: 6KHz (-6dB/oct.) 100Hz (6dB/oct.)
FILTER	
BASS BOOST:	
■ OTHERS	
TRANSISTORS, ETC.	SILICON TRANSISTORS (33), DIODES (2) VARISTERS (4) Attenuator (-18dB), speakers switch (main/remote) Tape monitor (2 sets), pre/main amp separator, headphone jack, etc.
ANNEXED CONTROLS	200 watts (maximum output, 8Ω, both channels driven)
POWER CONSUMPTION	160mm (6-5/16")H, 450mm (17-3/4")W, 268mm (10-9/16")D
DIMENSIONS	
WEIGHT	11 kgs (22 Lbs)

NOMENCLATURE AND USAGE OF EACH CONTROL

1. Bass Level Control (BASS)

A clockwise turn of the knob boosts the bass response, and counter-clockwise decreases and cuts off. This knob has the click-stopper of 11 points, and yields flat frequency response at the centre of rotation angle. You can choose a turn-over (roll-off) frequency at either of 150Hz, 300Hz and 600Hz with the selector switch (2).

This level control is of friction type double structure, and permits separate control of both right and left channels. The outer one is for right channel, and inner for left. Usually this knob controls both channels simultaneously. In order to control either of both channels you may turn the control for your desired channel fixing by hand that for the other channel. The click-stoppers are only for outer axis of volume, i.e., for right channel.

2. Bass Frequency Selector Switch

Bass turn-over or roll-off frequencies can be selected by this switch. When the desired frequency (150Hz, 300Hz or 600Hz) is set by this switch tone control starts to function

at the selected frequency. At the position of "defeat" a flat frequency response is obtained irrespective of the position of Bass Level Control (1).

3. Treble Level Control (TREBLE)

A clockwise turn of this knob boosts the treble response, while counter-clockwise decreases and cuts off. This volume control is of same structure as that of Bass Level Control (1) and an operation corresponds to what is expressed in (1).

4. Treble Frequency Selector Switch

Function-wise this is same with Bass Frequency Selector Switch expressed in (2).

5. Input Selector Switch

This switch permits proper selection of desired programme sources. You may set either of the positions (PHONO-1, PHONO-2, AUX-1, AUX-2, AUX-3).

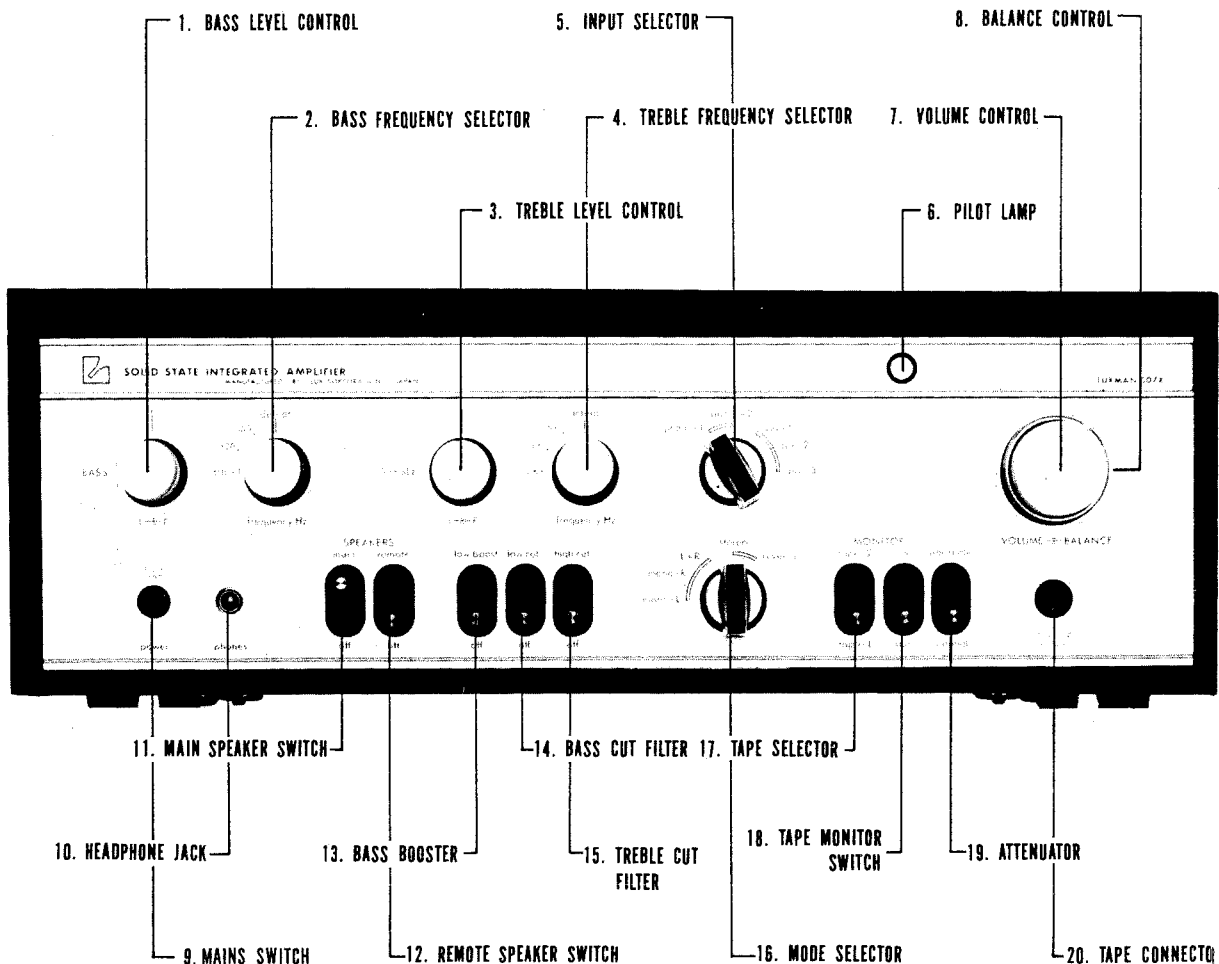

6. Pilot Lamp

Switch-on of the Mains Switch (9) causes to light this lamp, which shows the mains current is on.

7. Volume Control (VOLUME)

This knob controls volume: Clockwise turn boosts volume, which counter-clockwise decreases until inaudible point.

8. Balance Control (BALANCE)

The volume balance on right and left channels can be adjusted by this control. Turn it clockwise and the volume of left channel will decrease and finally cut off, while counter-clockwise turn causes to cut off right channel. When the volume on both channels is balanced, monaural reproduction sound comes from the centre of both right and left speakers. Usually this point is obtained at the centre of balancer (click-stop point), i.e., the centre point of the knob.

9. Mains Switch (POWER)

Repetition of pressing ensures alternately switch-on and switch-off.

10. Headphone Jack (phones)

Connection of stereophonic headphone to this jack allows private listening. Output signal is always available irrespective of the position of Speaker main (11) and Speaker remote (12).

11. 12. Speaker Switches

Sound reproduction from 2 stereo-playback speaker systems can be controlled by these switches: Independent or simultaneous driving of 2 speaker systems is feasible.

When the lever of the main speaker (11) switch is lifted up main speaker terminals (34) start to function, while pressed down to the position of "off" stop to function. The same is applicable to the remote speaker switch (12). Simultaneous operation of both speaker switches ensures so-called system A + system B operation.

For use of stereophonic headphone it is recommended to cut off both speaker switches.

13. Bass Booster (LOW BOOST)

Switch-on of this control intensifies bass frequencies below 100Hz at the rate of 6dB/octave. This circuit only valid for extremely low range permits wider and flexible tone adjustment in combination with other tone controls. Refer to the "Operation of Low Booster" for further details.

14. Bass Cut Filter

When this control is switched on, low frequency range below 70Hz can be cut off at the rate of 6dB/Octave. Further details can be seen in the "Operation of Low Cut Filter."

15. Treble Cut Filter

Setting of this switch causes to cut off high frequency range above 6KHz with the slope of 5dB/Octave. See the further details in the "Operation of High Cut Filter."

16. Mode Selector Switch

With this switch you can select sound reproduction modes such as Stereophonic and Monaural. For further details please refer to the "Mode Selection".

17. 18. Tape Monitor Switches

The switch (18) is called Monitor Switch and that of (17) is called Tape-Recorder Selector Switch. Generally we call them Tape Monitor Switch. When the monitor switch (18) is lifted up to the position of "in", play-back from tape-recorder is feasible either from tape monitor terminals TAPE-1 (29) or TAPE-2 (30) or tape-connector (20). If switched off to the position of "out" sound reproduction is possible from other sources except tape-recorder (PHONO and AUX terminals). The tape-recorder selector switch (17) permits selection between tape monitor terminals TAPE-1 (29) and TAPE-2 (30) at the time of "in" position for monitor switch (18). In this switch tape-1 and tape-2 correspond to the terminals TAPE-1 (29) and TAPE-2 (30). For play-back from tape-recorder connected to the terminal TAPE-1 (29) this switch (17) must be in the position of "tape-1" keeping the monitor switch (18) on the "in" position. The same is applicable to "tape-2" position. Tape connector (20) is functionable only when the switch is set to the position of "tape-2", i.e., this connector functions in parallel with TAPE-2 (30).

In case of 3-head tape-recorder which has playback head for playback in the course of recording, simultaneous playback monitoring is feasible while recording. In this case this amplifier receives the playback signals either tape monitor terminals (29) (30) or tape connector (20), while feeding the recording signals to the recording output terminals (28) or tape connector (20). Be attentive that if monitor switch (18) is on the "in" position no playback is feasible from other programme sources (PHONO and AUX).

19. Attenuator (attenuate)

This is usually set in the position of "normal". Lift this switch and an attenuator begins to function decreasing the

gain by 18dB. Useful as a momentary volume-subduing switch of speakers.

20. Tape Connector (tape-2 in/out)

This connector is of DIN standard. With recording output terminal (REC OUT) and tape monitor terminal in it, connection for recording and playback is feasible with a single lead-wire of DIN plug if the tape-recorder has the same connector. For playback through this connector the monitor switch (18) must be on the "in" position and the tape-recorder selector switch (17) on the "tape-2" position. Recording output signal is always available from this connector.

21. Earth Terminal (GND)

Connect the earth lead wire of record player (from motor or pick-up arm). This terminal may be used for earthing of this-amplifier, which is, however, not always necessary.

22. Phono-1 Terminal

For playback through magnetic pick-up (MM, MI, MC

type). Input sensitivity 2mV. Input impedance is selectable among $100K\Omega$, $50K\Omega$ and $30K\Omega$. Except very low output MC type pick-up (output voltage 0.01mV-0.1mV) almost all pick-ups can be used. For such MC type cartridges of extremely low output level, it is necessary to boost the voltage up to the specified level by use of step-up transformers or head-amplifier.

23. Input Impedance Selector for Phono-1

This selector permits to select the desired impedance among $100K\Omega$, $50K\Omega$ and $30K\Omega$. With MM type cartridge frequency response varies according to load impedance. For the cartridges which tend to intensify the high frequency range set the load impedance to the position of "30K Ω ". On the contrary for what tend to attenuate setting at "100K Ω " is recommended. Of course this is applicable to the pick-up of $50K\Omega$ impedance which is nowadays dominant in the market. For this amplifier, therefore, the selector is set at $50K\Omega$.

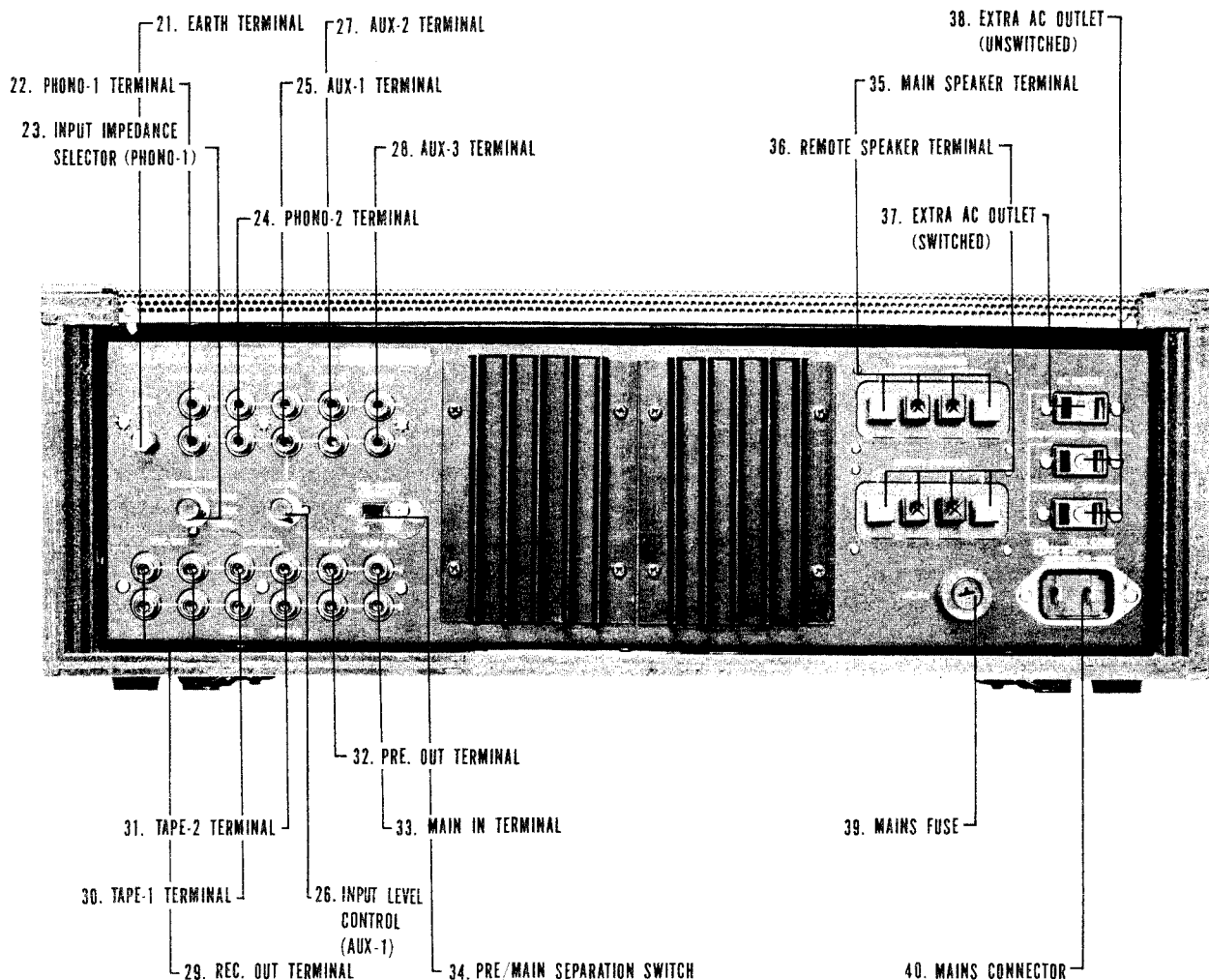

24. Phone-2 Terminal

Same with phono-1 terminal except that the input impedance is not interchangeable.

25. 27. 28. Aux-1. 2. 3. Terminals

This is an auxiliary input terminal for playback of flat frequency response such as AM/FM stereo-tuner, line output of tape-recorder, and audio output of television receiver. Input sensitivity 80mV, and input impedance 30K Ω . Input level is unchangeable except 25 (Aux-1).

26. Input Level Control for Aux-1

This is a volume to control input sensitivity for Aux-1. Even in case an equipment of high output voltage is connected this control permits adjustment of input level to an appropriate level. This amplifier is usually delivered with this control set at an extreme and of clockwise direction.

29. Rec. Out Terminal (Recording Output Terminal)

Signal for recording is taken out from this terminal. The recording signal can be provided to 2 tape-recorders. These 2 terminals are wired in parallel in the inside circuit.

30. TAPE-1 Terminal (Tape Monitor Terminal)

Line output of tape-recorder can be reproduced from this terminal. For this purpose set the monitor switch (18) at the "in" position and tape selector switch (17) at the position of "tape-1". In case of 3-head tape-recorder so called tape-monitoring is feasible — simultaneous recording and playback.

31. TAPE-2 Terminal (Tape Monitor Terminal)

Same function with that of above terminal (30). Either of 2 sets of tape-recorder can be connected and operated with selection by tape selector switch (17).

32. Pre-Amplifier Section Output Terminal (PRE OUT)

Whole output in pre-amplifier section including tone controls can be taken out from this terminal. Output voltage is 430mV against the standard input. No need to worry about attenuation in high frequency range caused by use of shield wire by dint of sufficiently low output impedance of about 100 Ω . This terminal is used for independent use of pre-amplifier as well as for multi-amplifier system by use of channel divider. Usually this terminal and main-amplifier input terminal (33) are coupled through pre-main amplifier separation switch (34).

33. Main-Amplifier Section Input Terminal (MAIN IN)

Main-amplifier section can be independently functioned

feeding the signal through this terminal by use of pre-main amplifier separation switch.

34. Pre-Main Amplifier Separation Switch

Use this switch when pre-amplifier and main-amplifier sections of this amplifier are independently functioned. This amplifier is usually used as the pre-main amplifier, and is delivered with the switch locked at the "on" position. In order to separate pre-main sections, loosen the screw and set the switch at the "off" position.

35. 36. Speaker Terminals

The speaker systems should be connected to these terminals. Press the cap of the terminal and insert the speaker cord to the terminal hole. Then release it. Firm connection is now finished. These terminals are coupled with the speaker switches, and either of the speaker switches corresponding to the terminal to which the speaker systems are connected must be set at the "on" position. (35) is for main speaker and (36) for remote speaker. Red terminal is for \oplus and black for \ominus .

For further details refer to the "Connection of Speakers".

37. 38. Extra Mains Outlets

Convenient for supply of mains power to other equipments such as AM/FM tuner and record player. The terminal (37) UNSWITCHED) is independent of the mains switch of this amplifier, while these (38) of (SWITCHED) are coupled with the mains switch, and supply of the mains power depends on the mains switch. The maximum rated value for (37) is 200 W and the total capacity for both of (38) is 100W.

39. Mains Fuse

In the mains power circuit of this amplifier inserted is 3A fuse. When the fuse gets blown replace it ascertaining the cause of such blow. Replacement can be easily done by turning the fuse cap to the direct of arrow mark with \oplus driver. Be sure that the mains cord is free from the mains power supply point.

40. Mains Connector

One end of the attached mains cord should be connected to this point, while the other end with plug be inserted to the mains power supply jack.

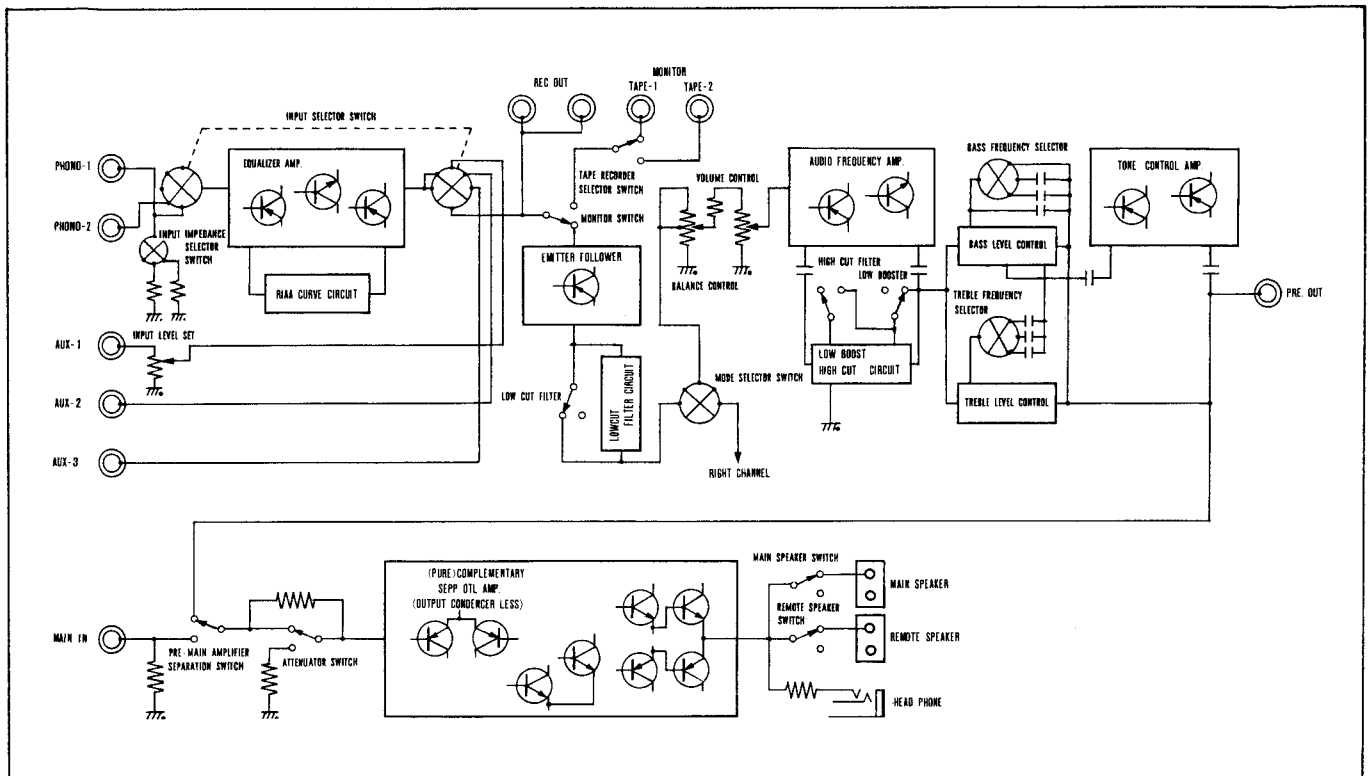

FOR CORRECT PLAYBACK

■ Inputs (Connection of Input Equipments)

Check firm connection to the amplifier's input terminals of output terminals of record players, tape-recorders and AM/FM tuners etc. If no playback sound comes from speaker systems, the amplifier is apt to be, first of all, wondered as defective, but be sure about firm connection between arm and cartridge and also firm fixation of cartridge to the shell.

■ Outputs (Connection of Speaker Systems)

Check firm connection between amplifier and speakers. The righthand speaker viewed from the listener's position must be connected to the RIGHT terminals of the amplifier, while the left speaker to the LEFT terminals. Be careful about the matching phase of left and right speakers. If mismatched, playback sound does not come from the centre of both speakers even if the mode selector is set at the "MONO" position, and in case of stereophonic playback faithful reproduction in low frequency range cannot be expected. Be sure that the speaker switch corresponding to the speaker terminals to which the speaker is connected is turned on.

■ Mains Source (Connection to Mains Source)

Check whether the mains plug of amplifier is firmly connected to the mains power source, and whether the pilot lamp lights on when switched on. In case the pilot lamp does not light on even if the electricity is fed to the amplifier, check whether the mains fuse is blown.

Affirmatively change the fuse ascertaining the real cause of blow and giving necessary treatment. Replacement of fuse must be done after the mains cord is plugged out from the mains power supply point.

■ Input Selector Switch

Check correct positioning of the switch corresponding to the input terminals (PHONO, AUX) to which input equipments and connected.

■ Tape Monitor Switch

For normal playback never fail to set this switch at the "out" position. Playback with tape-recorder is feasible with this switch "in" and correct selection of tape-recorder selector switch at the corresponding tape-monitor terminal. But for reproduction through tape connector the setting of tape-recorder selector switch should be at the position of "tape-2".

■ Volume Control

Full turn of this knob to the counter-clockwise direction causes to yield no sound. Turn to the clockwise direction and enjoy playback at an appropriate volume.

■ Balance Control

Adjust unbalanced volumes between right and left channels. Turn to the ultimate point causes to suppress the sound completely in the corresponding channel. Usually this knob is set at the centre click-stop point for stereophonic reproduction.

■ Attenuator

Setting of this switch subdues the volume by 18dB (about 1/8). In case full volume cannot be obtained with ultimate clockwise turn of volume control, check if this switch is on operation. To release the attenuator under full volume causes to yield sudden increase of volume and sometimes destroy speakers: To release attenuator under small volume is essential.

■ Mode Selector

This switch is to select the mode of reproduction. For stereophonic reproduction set at the position of "stereo", otherwise stereophonic reproduction cannot be obtained even if input signal is stereophonic.

■ Pre-Main Amplifier Separation Switch.

For pre-main amplifier use this amplifier as it is. For independent use of pre-and main-amplifiers set this switch at the "off" position loosening the fixing screw for plastic plate.

HOW TO CONNECT

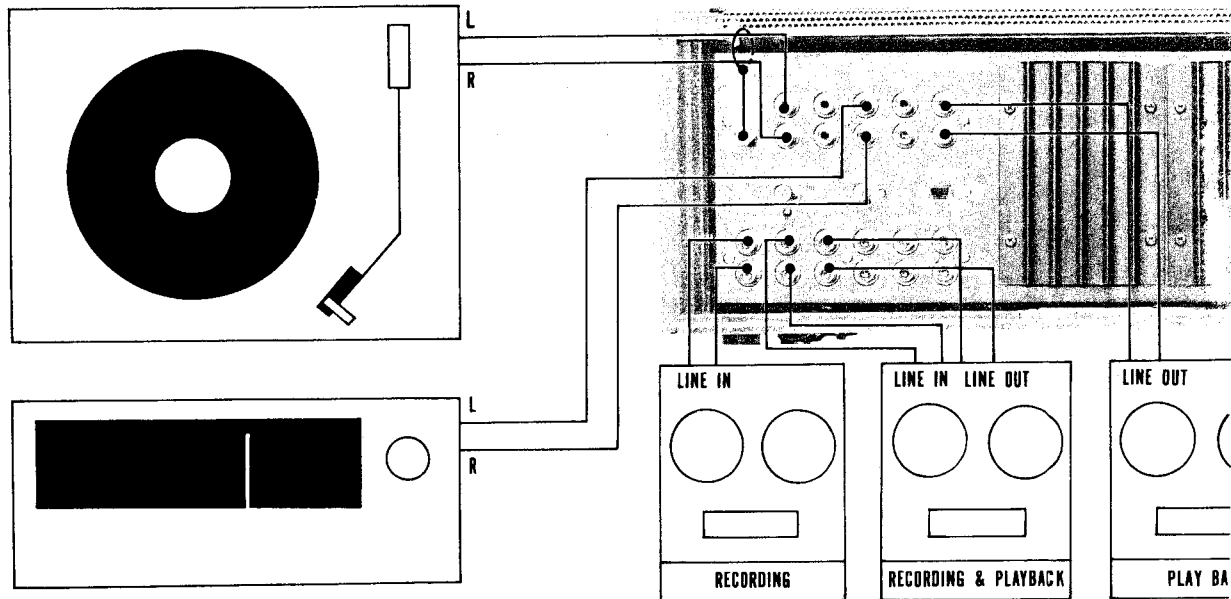

Basic Connections

This amplifier is so called pre-main amplifier composed by pre-amplifier section which controls playback equipments and power amplifier section which amplifies the signal to the extent that it drives the speaker systems. It functions as the stereophonic reproduction system when player, tuner etc. are connected to the input terminals and speakers or headphone to the output terminals. Thus it is basically necessary to connect this amplifier with the input sources, output loads and naturally mains current.

Connection to Input Terminals

Connect at the relevant input terminals of this amplifier the outputs of player, tuner, or tape-recorder. As to the details see the chapters of Playback of Disc, Tuner and Tape-Recorder.

Connection Cable (Cord Wire)

For connection of these record-player, tuner and tape-recorder shield wire is used for protection from external noise or inductance noise. Usually this shield wire has the capacitance of approx. 300pF/M, that is to say, an

adoption of connection cable gives the same effect to that of the insertion of capacitor in parallel with input sources or output load equipments, which composes a kind of high-cut filter circuit. For instance 2 meters of this shield wire has 600pF capacitance, and if this cord is used at the point where parallel composite value of input and output impedance is $50K\Omega$, it means an insertion of a high-cut filter with the cut-off frequency at about 10KHz, which causes to yield an unnecessary attenuation of high frequency range. Use of shortest wire is, therefore, recommended especially on the equipments of high impedance.

Choose a shield wire of good quality and use it as short as possible for connection of this amplifier at the PHONO, AUX, tape-monitor, tape connector etc. with the apparatus of high impedance. In case either of input or output is sufficiently low it does not effect much, since parallel composite impedance becomes lower and cut-off frequency will be shifted out of an audible range. It does not matter if relatively long cable is used for preamplifier section output and recording output (REC. OUT) terminals, since their impedance is so designed as to be sufficiently low (approx. 100).

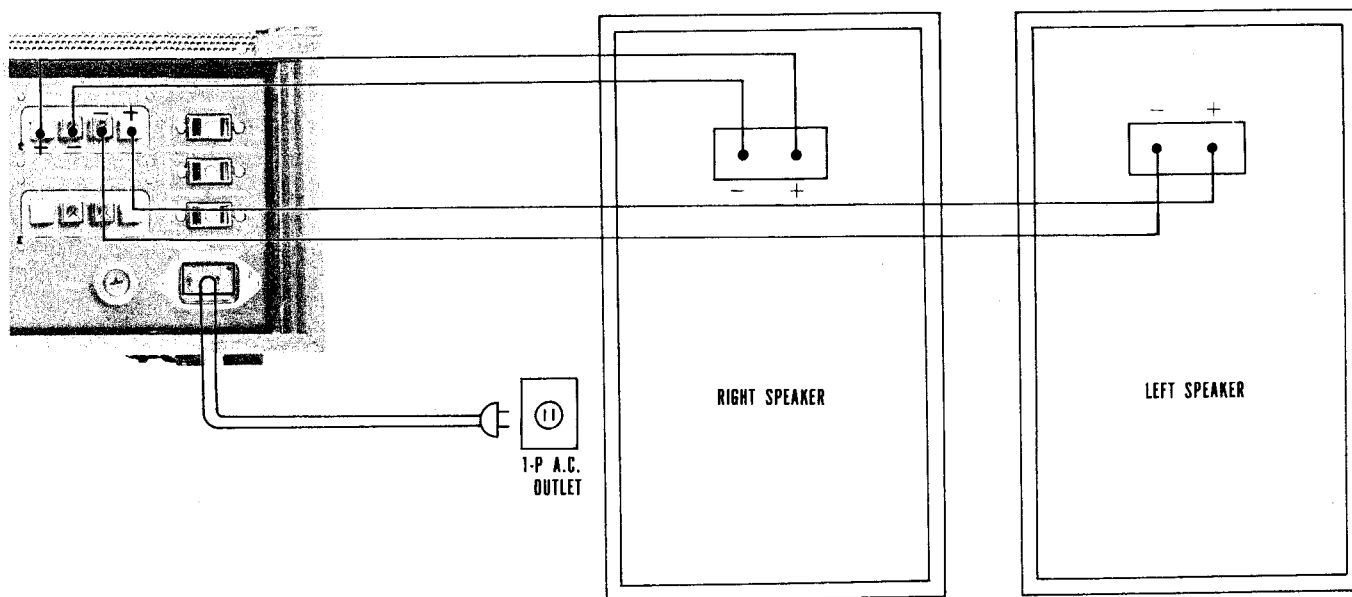

Connection of Speakers

Stereophonic playback is made with a pair of speaker systems for right channel and left channel. This amplifier is provided with 2 channels' terminals for main speakers and remote speakers. Connection can be made in the same manner.

Right hand speaker system (viewed from the listener's position) should be connected to the right speaker terminals, while left speaker system to the left terminals.

Note that perfect sound reproduction cannot be expected if the phase is not matched between both channels. To match the phase is to connect the \oplus terminal of the right hand speaker to \oplus terminal (red cap) in right channel of this amplifier and the \ominus terminal to \ominus one (black cap), and to do the same with left channel speaker. If mismatched for some reasons (for example mis-connection of speakers) low frequency range is subdued and constant playback cannot be realized.

To connect the speaker terminals first strip off the end of shield wire by 10mm and insert it to the terminal hole pressing the terminal head, and then release it. You will find firm connection has been finished.

After connection of the speaker, lift up the speaker switch to the "on" position and 2 pairs (remote and main) of speaker systems can be simultaneously or independently driven.

Connection of Mains Power Supply Source

As the final step of preparation connect the amplifier to the mains power supply source. Attached mains cord should be connected to the mains connector supply source. Attached mains cord should be connected to the mains connector of this amplifier and the other end should be plugged into the mains power supply receptacle. Then press the mains switch and the pilot lamp starts to light up and the amplifier will be on function in about 2 – 3 seconds.

The mains power for other audio equipment used in combination with this amplifier can be obtained from the extra mains outlets (SWITCHED) of the amplifier. In this case repetition of ON/OFF switching on this amplifier is common to that on other annexed audio equipments. If the mains power of the amplifier is switched on, the mains switch on the other audio apparatus works simultaneously.

PLAYBACK FROM RECORD DISC

■ Connections

Generally a record player consists of a turn-table ensuring constant rotation of the record disc, a pick-up (cartridge) whose stylus (needle) traces the sound groove of the disc converting the physical signal of the recorded sound into the electric signal, and the arm which holds this cartridge. The player has 2 cords with pin plug at its end for both right and left channels. Connect the pin connectors to the input terminals of this amplifier [PHONO-1 (22) or PHONO-2 (24)]. A probable earth lead of player may be connected to the GND terminal (21) of this amplifier. A mains cord of the player to drive its motor may be connected to the convenient extra mains outlet (37) of this amplifier.

This amplifier is provided with 2 input terminals (PHONO-1 and PHONO-2) to be selected by the input selector switch (5), which is useful for comparison test of 2 pick-ups or using 2 record players. For use of 1 player either of 2 input terminals can be selected. But in case MM (moving magnet) type cartridge is used, it will be convenient to select PHONO-1, for interchangeability of input impedance can give a proper load to the cartridge.

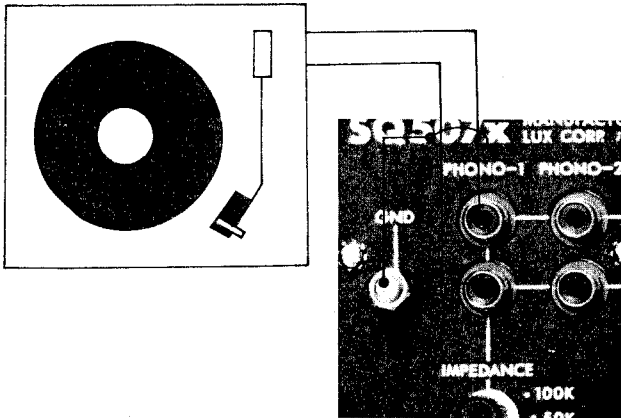

■ Signal Paths

Put the disc on the turn-table, switch on the phono motor, and set the stylus on the groove of disc. Then recorded signals begin to be fed to the amplifier. First the signals fed to the amplifier through PHONO terminals are brought to the equalizer section, where recorded signals are equalized and restored to the original frequency curve. Incidentally this equalizer curve has been standardized in the RIAA curve. The equalized signals are then fed to the input selector switch (function switch). If this switch is not set at the correct position of PHONO, the signals are blocked here and no more advance is possible.

Then the signals are divided into 2 channels, which are kept at sufficiently low impedance (about 100Ω which prevents possible attenuation in high frequency caused by lengthy cable or floating capacitance) by dint of emitter-follower

stage annexed at the last portion of equalizer section. One line to the REC. OUT terminal, and the other to the tape monitor switch. If the monitor switch (18) is set at the "out" position, the signals are sent to the mode selector switch, balance control and volume control, but if at the "in" position the tape monitor terminals start to function and the signals are stopped at this point. Except when the tape playback is made by tape monitor terminals, the monitor switch must be kept at the "out" position. But when the input signals are fed to PHONO or AUX terminals recording output is always obtainable regardless of the position of the monitor switch. Then the signals are sent to the volume control through the mode selector and balance control. If the volume knob is turned to the extreme end of counter-clockwise direction, the signals cannot proceed ahead. It is necessary to set this control at the optimum volume.

Such controls as low-cut filter, high-cut filter, attenuator, low booster, and tone controls are for flexible and diversified adjustment of playback sound and do not block the signals completely.

As far as the pre-main amplifier separation switch is kept unchanged at the "ON" position, the signals reach the speaker switches amplified by the main amplifier. Sound playback from speaker systems is thus realized if the speaker switch corresponding to the speaker terminals to which the speakers are connected is set at the "on" position.

The above is the feeding path of PHONO signals starting from input terminals to the speaker systems. Difficult as it may sound you can easily understand it from the attached block diagramme. For your pleasant command of this amplifier we recommend you to bear the block diagramme in your mind.

■ Playback Performance

Now put a disc on the turn-table for playback performance. As the volume control is turned clockwise from the cut position, playback sound comes out from speakers. As explained in the paragraph of Signal Paths the sound playback is possible regardless of the position of Mode Selector etc. as far as these essential controls are set at the correct position such as Input Selector Switch (5), Monitor Switch (18), Pre-Main Amplifier Separation Switch (34), Speaker Switches (11) (12) and Volume Control (7).

Now all preparations have been completed. Check if the volume levels on both right and left speakers are identical. If deviated adjust it by the Balance Control. For stereophonic playback see to it that the Mode Selector Switch is kept at the "stereo" position, otherwise stereophonic playback is not feasible.

PLAYBACK OF AM/FM BROADCASTING PROGRAMME

Connection of the output terminals of AM/FM tuner to the AUX terminal of this amplifier ensures playback of AM/FM broadcasting programme. This amplifier is provided with 3 AUX terminals (25) (27) (28) and you may connect whichever you like. The Input Selector Switch must be set at the corresponding position.

As shown in the block diagramme the input signals from tuner are directly fed to the Input Selector Switch. Afterwards the signals trace the same blocks as explained in the paragraph of Playback from Record Disc, and are reproduced from the speaker systems. Both for FM stereophonic and monaural broadcasting the Mode Selector Switch can be set at the position of "stereo", for such accomodation to the input source can be made in the tuner. In case of AM programme there is possible trouble of modulation hum, which can be eliminated by varying the distance and angle of these components.

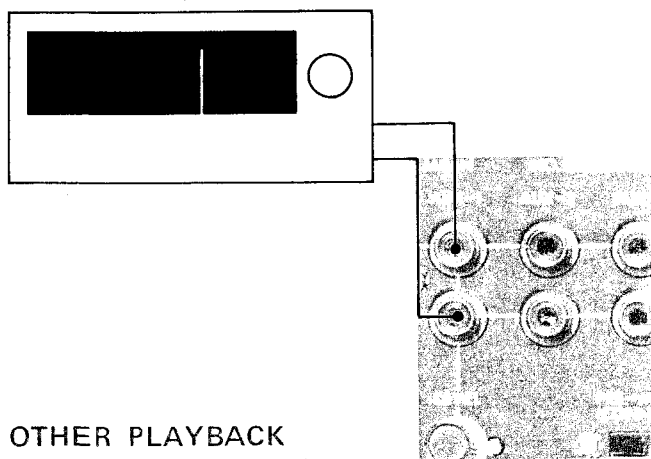

OTHER PLAYBACK

The signals of flat frequency response from such sources as TV receivers do not need an equalizer stage, and for playback of such audio equipments any of these AUX terminals can be used. Connection and operation is same with that of AM/FM broadcasting programme.

PLAYBACK FROM TAPE

■ Playback from Tape Monitor Terminals

Almost all of tape-recorder; and tape-decks currently marketed integrate audio amplifier in the circuit. Also there is a tape-player exclusively for playback. Connect the output terminal (LINE OUT) to the Tape Monitor Terminals (30) (31). Then set the Monitor Switch at the "in" position and the Tape-Recorder Selector Switch (17) at the corresponding position to which the tape-recorder is connected, and the playback from tape is realized. If 2 tape recorders are connected to the Terminals (30) and (31), selection between 2 tape-recorders is possible by the Tape-Recorder Selector Switch (17). This amplifier can be

divided into 2 sections — one before the Recording Output Terminals (REC. OUT) and the other after the Tape Monitor Switch, and 3-head tape-recorder makes it feasible to make recording with the former section and simultaneously to make playback with the latter section.

Note that normal function cannot be expected if 2 sets of tape-recorder for playback are connected to the terminals of TAPE-2 and Tape Connector (20) at the same time, since these 2 are coupled in the inside circuit and effect on each other. Therefore if Tape-Minotor Terminals and Tape Connector are used the tape-recorders should be connected to the terminals of TAPE-1 (with the Tape-Recorder Selector Switch at the position of "tape-1") and the Tape Connector.

■ Playback from AUX Terminals

Playback of tape is possible if the line output of tape recorder or tape-deck is connected to the AUX terminals of this amplifier by use of pin-jack lead and the Input Selector Switch is set at the corresponding position to the AUX Terminals. All operations in this case are same with those for the Playback of Tuner. Note that when tape playback is made through AUX terminals the line input or AUX input terminals should be kept free. If connected to the Recording Output Terminals (REC. OUT) of the amplifier there will be possible oscillation by feed-back of signals.

■ Playback from Tape Connector

This connector is of DIN norm, and very convenient for simple connection by a single cord between the tape-recorder and recording/playback connectors of this amplifier. A DIN cord should be connected between DIN connector of the tape-recorder and Tape Connector of this amplifier. Playback from Tape Connector is possible if the Monitor Switch is set at the "in" position and the Tape-Recorder Selector Switch at the "tape-2" position.

RECORDING ON TAPE

In case of playback of various programme sources through input terminals of this amplifier, the same signals to these reproduced in speakers are always available at the Recording Output Terminals (29) and Tape Connector (20). By connection of these terminals to the input terminals (AUX or LINE-IN) of the tape recorder you can enjoy simultaneous recording and playback. These recording signals are taken out before the Tape Monitor Switch and there is no influence of such controls as Volume Controls, Tone Controls and Filters etc.

If there are 2 tape-recorders reprinting of tape is feasible; Connect the tape-recorder of better recording performance to the Recording Output Terminals and other one to the AUX terminals exclusively for playback setting the Input Selector Switch to the relevant position.

SIMULTANEOUS PLAYBACK MONITORING

3-head tape-recorder ensures Simultaneous Playback Monitoring enabling to ascertain perfect recording. In case of 3-head tape-recorder heads and amplifiers for recording and playback exist independently in the circuit, which ensures simultaneous recording on tape and playback of the sound recorded on the tape.

In this case recording on tape and playback of the recorded sound is practised at the same time, and connection must be made for both functions. Need to connect the Recording Output Terminals (29) to the Line Output Terminals (AUX Input) of tape-recorder, and the Tape Monitor Terminals (30) or (31) to the Output Terminals (LINE OUT) of the tape-recorder.

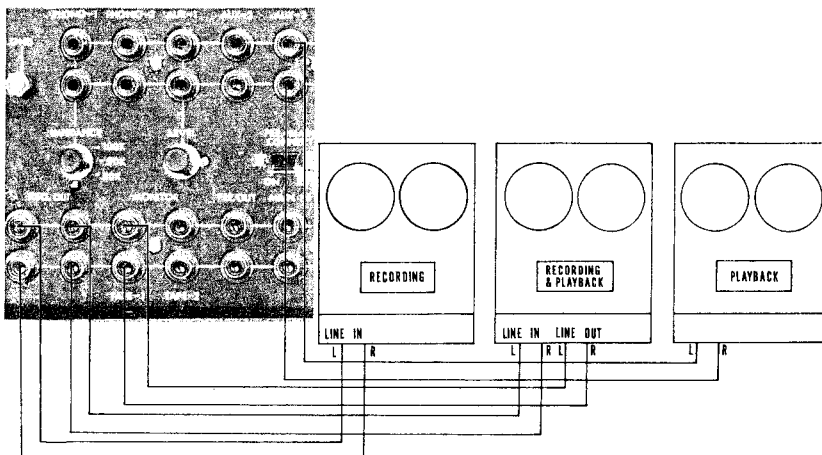

About DIN Tape Connector

The Tape Connector of this amplifier is provided at the front panel for convenient connection. This is of DIN norm. As explained in the paragraph of Playback from Tape and Recording on Tape, if tape-recorder is equipped with DIN connector, connection by a

The Tape-Recorder Selector Switch (17) is set at the position corresponding to the terminals to which the tape-recorder is connected, and repetition of switching "in" and "out" makes it feasible to compare the original sound with recorded one. Thus possible recording error can be prevented in case of 3-head tape-recorder. Incidentally note that reproduction of recorded sound becomes a little bit delayed as compared with that of original sound since there is a gap between recording head and playback head.

Simultaneous Playback Monitoring can be made through the Tape Connector (20) as well. A single piece of DIN cord ensures connection for recording and playback, and simple operation of switching "in" and "out" of the Monitor Switch is sufficient if the Tape-Recorder Selector Switch is set at the "tape-2" position.

SIMULTANEOUS RECORDING

This amplifier is provided with 2 sets of Recording Output Terminals (REC. OUT) enabling to record simultaneously on 2 tape-recorders. If desired, combination recording on open-reel recorders and/or cassette recorders can be enjoyed. Moreover if the Tape Connector is used recording on 3 tape-recorders is possible.

This facility is useful for safer printing or effective recording etc. As the impedance at the Recording Output Terminals is kept sufficiently low (about 100Ω), mutual interference will be almost nil between the recorders under simultaneous operation.

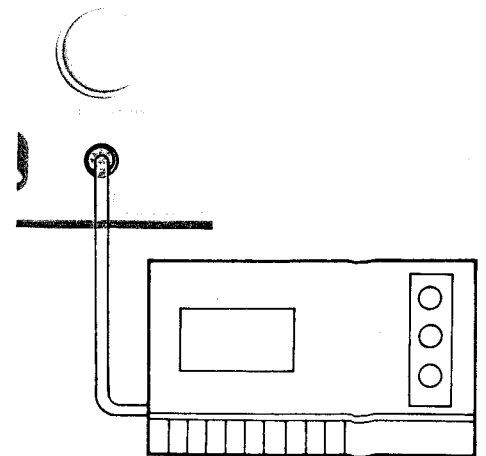

single piece of DIN cord suffices for recording and playback. See to it that this connection is practised only by DIN cord since the impedance at Recording Output Terminals is kept relatively high at $80K\Omega \pm 20K\Omega$.

OPERATION OF TONE CONTROLS

Selection of Mode (Conversion of Playback Mode)

This amplifier is for stereophonic reproduction and integrates independent amplifiers for 2 channels (right and left). Without the Mode Selector the signals fed to the right channel terminal is reproduced at the right channel speaker. The Mode Selector is placed between these 2 amplifiers to change the mode of reproduction.

knob position	connection		performance	use
	input	output		
STEREO NORMAL	R → R L → L	R L	normal stereo playback	for normal stereo playback
STEREO REVERSE	R → L L → R	R L	reversed stereo playback	when program source is reversly connected
MONO R	R → R L → R	R L	right input signals is reproduced from both right and left speakers	for monaural program source playback
MONO L	R → L L → L	R L	left input signal is reproduced from both right and left speakers	
MONO R + L	R → R L → L	R L	right and left input signals are integrated	for playback of monaural record with a stereo phono pick-up

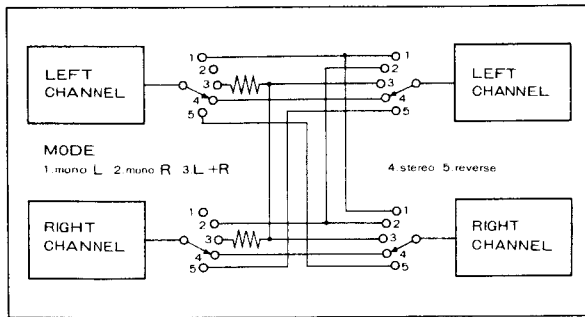

Control of Volume

Sound volume can be properly adjusted by volume control. The variable resistor yields A type curve. In the attenuation characteristics of A type turning angle is proportionate to attenuation degree of dB, and the dB value and the volume audible to human ears are in the proportionate relation. That is to say, the rotation of knob is in proportion to the sound volume felt by human ears. The increasing degree of volume is felt quite natural as the knob is turned on to the clockwise direction.

Control of Volume Balance

In case of deviation between the volume levels of right and left channels, adjust unbalanced volume level by the Balance Control (8). A complete turn of the knob to either of clockwise or counter-clockwise direction causes to cut off the volume of the other end speaker. The volume balance of both channels can be adjusted so that monaural disc sound reproduced by the stereo cartridge comes from the centre of the right and left channels. Usually the volume level of both channels can be adjusted identical at the centre click-stop position of the balancer. Thus a proper balance is established through whole of playback stages. If a

programme source has deviation of the volume level between 2 channels, establish correct balance with this balancer.

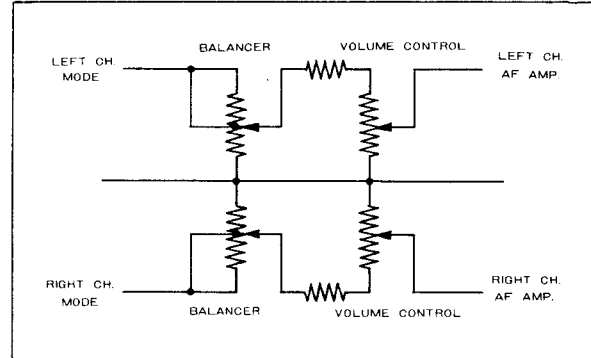

Tone Controls

The ultimate purpose of the audio system is to make the high fidelity reproduction of programme sources. The reproduction conditions and circumstances do not always match with recording conditions, and it is impossible to reproduce the same sound with the original one. Also there is no objective standard to judge good sound from inferior one. The only possible solution is for every listener to create his favorite sound according to his own taste. It is therefore very important that the audio system offers such facility to permit flexible controls for creation of the best sound. This amplifier is equipped with the LUX original NF type turn-over roll-off frequency selector for subtle and minute control of the reproduced sound. Tone controls include Bass Level Control (1), Bass Frequency Selector (2), Treble Level Control (3), and Treble Frequency Selector (4).

First of all note the followings: If Bass Frequency Selector (2) is set at the "defeat" position, low frequency range becomes of flat frequency response irrespective of the position of Bass Level Control (1), while if Treble Frequency Selector (4) at the "defeat" position high frequency range becomes of flat frequency response irrespective of the position of Treble Level Control (3). After setting the switches (2) and (4) at other position than "defeat" and controlling the level controls (1) and (3) as desired, if the switches (2) and (4) are again set at the "defeat" position you can obtain flat frequency response: Controlled tone and flat tone can be easily recognized.

Bass Frequency Selector (2) has 3 points, namely, 150Hz, 300Hz and 600Hz, and from this point Bass Level Control (1) starts to function. In other words turn-over and roll-off of lower frequency range below this point can be controlled by Bass Level Control (1). Controllable range is wider by order of 150Hz, 300Hz and 600Hz, and from this point Bass Level Control (1) starts to function.

Bass Level Control which functions in conjunction with Bass Frequency Selector is a tone control on frequency response of low frequency range. It is designed so that response is flat at the electric centre point, and a clockwise turn of the knob intensifies high frequency range while counter-clockwise turn yields attenuation. For easy adjustment this control is equipped with 11 points of click stopper.

This volume control is of friction type double structure, and usually both channels are controlled at the same time. Separate control of both channels is possible if one knob is turned fixing the other one by hand. Front one is for left channel and rear one is for right channel.

The same is applicable to Treble Level Control (3) and Treble Frequency Selector (4). The Treble Frequency Selector has 3 points, namely, 6KHz, 3KHz and 1.5KHz, (Controllable range is wider by this order) from which point the Treble Control starts to function. This knob is also with 11-point click stopper, and a clockwise attenuates. The knob is of same friction type double structure.

For details of these tone controls' characteristics, refer to the attached chart of response curve.

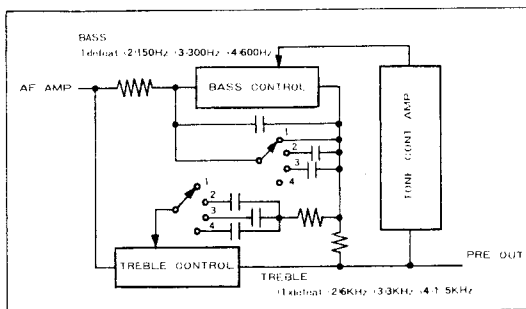

Operation of Low Cut Filter

When this filter (14) is switched on the low frequency range below 70Hz is cut off at the attenuation rate of 6dB/Octave. Useful for removal of low frequency noise such as rumbling of phono motor. Also this can be used as an auxiliary control for Bass Level Control.

Operation of High Cut Filter

When this filter (15) is switched on the high frequency range over 6KHz is cut off at the attenuation rate of 6dB/Octave. Useful for removal of scratch noise, hissing noise of tape etc. Also this can be used as an auxiliary control for Treble Level Control.

Operation of Low Booster

When this switch (18) is set on, low frequency range below 100Hz is intensified with a slope of 6dB/Octave. This circuit effective only on the extreme low frequency range allows flexible and versatile tone adjustment. For instance probable rise-up in small room of approx. 10m² in the neighbourhood of 150 – 200Hz can be subdued with switching on of this control by lowering the bass level with 300Hz position on Bass Frequency Selector. This process can suppress such unnecessary rise-up without spoiling the response at extreme low frequency range. Moreover when human voice sounds unnaturally stout, it can be adjusted as clear and natural one if this booster is switched on cutting low frequency range to small extent by Bass Level Control.

Operation of Attenuator Switch

This switch is usually set at the "normal" position. If switched over to the "attenuate" position attenuator starts to function and the gain will be attenuated by 18dB (about 1/8). Useful when subdued volume level is desired. Also this can be used as a momentary speaker silencing switch. Avoid switching over to "normal" at the high volume level, since sometimes such momentary big noise is reproduced as may destroy speakers. See to it that this switch is set to the "normal" position after using for attenuation.

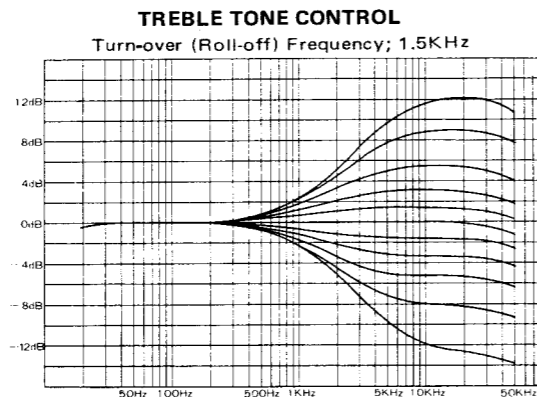
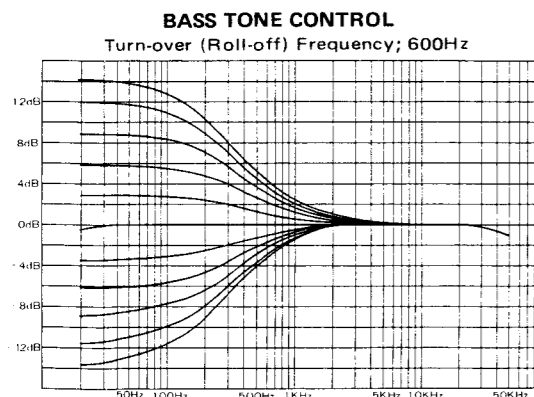
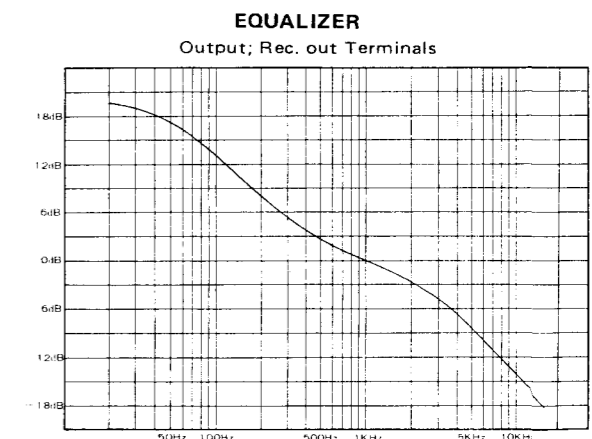
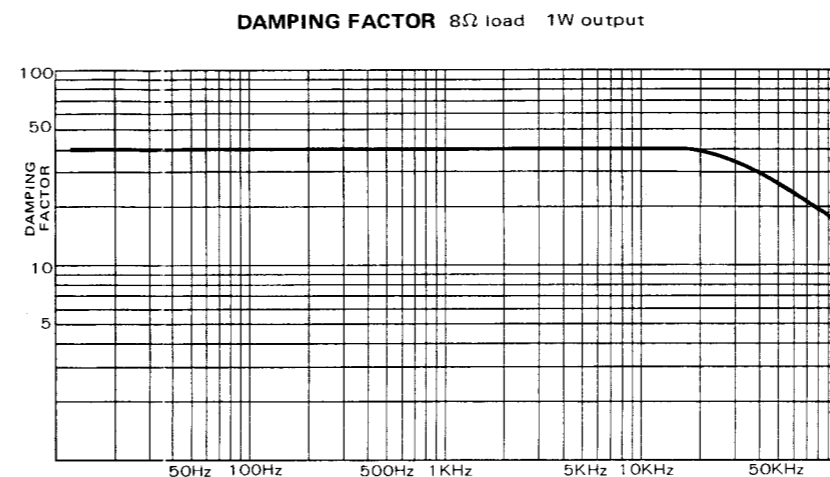
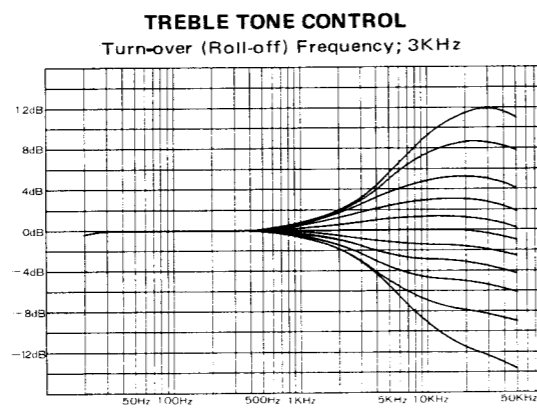
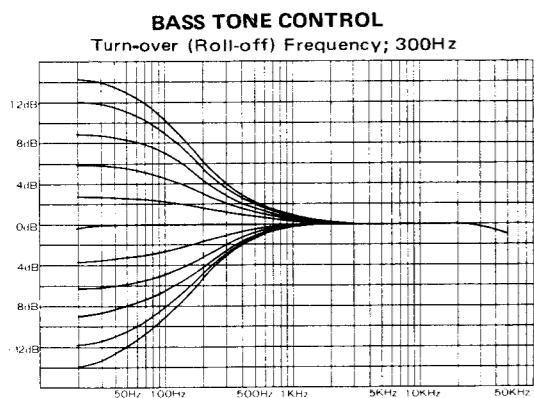
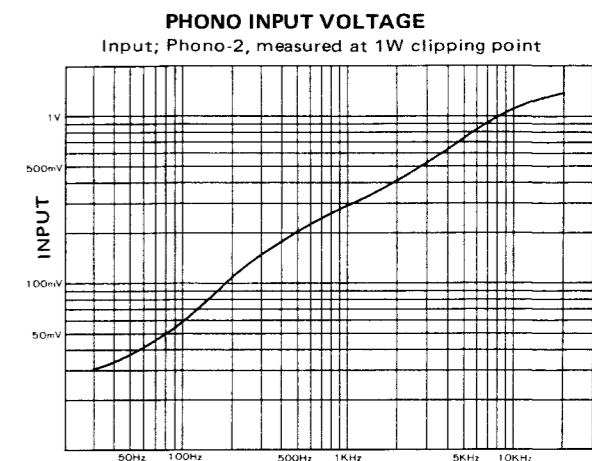
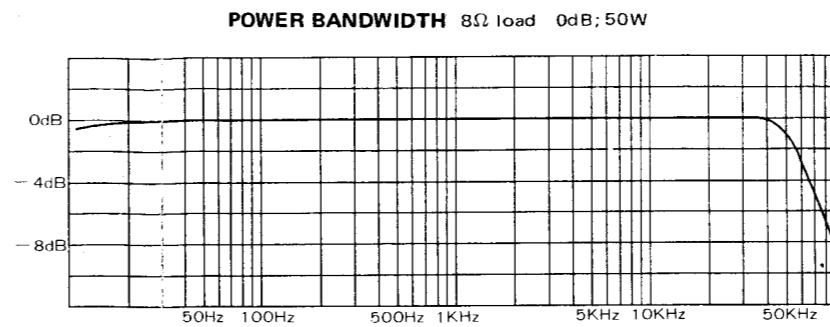
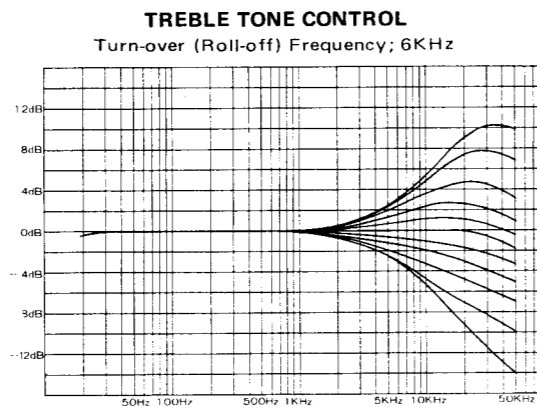
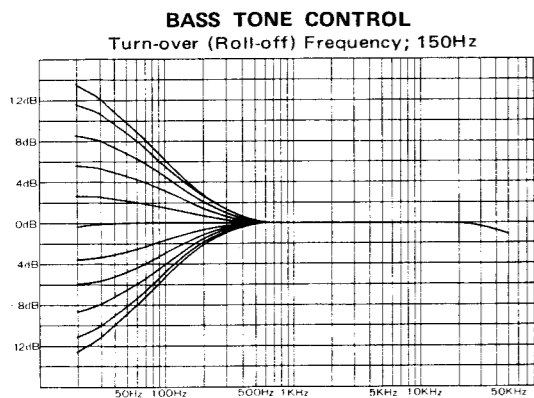

INTER-MODULATION DISTORTION
Input; Main in, Frequency and Modulation Ratio
70Hz; 7KHz±4 : 1

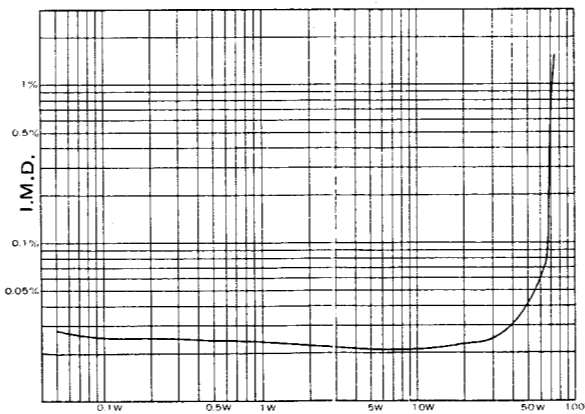

NOISE + HARMONIC DISTORTION
Input; Main in, 8Ω load, incl. oscillator distortion 0.03%

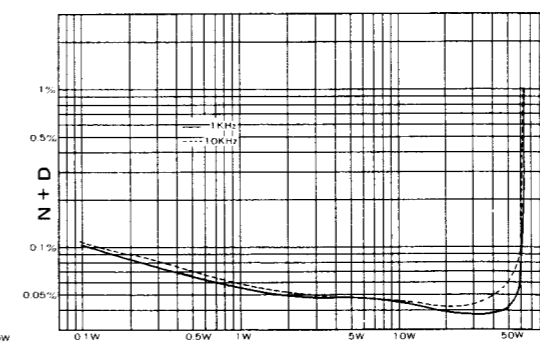

NOISE + HARMONIC DISTORTION
Input; Main in, 4Ω load, incl. oscillator distortion 0.03%

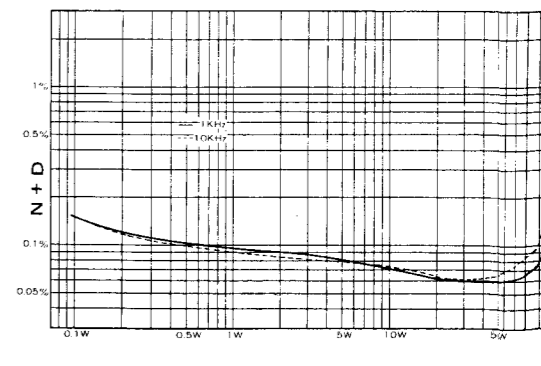

Pick-ups

There are various types of cartridges — magnetic type, photo-electric type, electrostatic type and piezo-electric type. Most predominant is magnetic type wherein included are MM (Moving Magnet), IM (Induced Magnet), MI (Moving Iron) and MC (Moving Coil), and the PHONO terminals of this amplifier is designed to match with the cartridges of these specified types. But the pick-up of low output level (output voltage 0.01 — 0.1mV) cannot be directly connected to this amplifier. As to this refer to the paragraph of Step-up Transformer for MC Type.

In case of photo-electric or electrostatic type, choose appropriate input terminals according to the explanation sheet of the cartridge. Among piezo-electric types there are crystal type and ceramic type, which can be generally connected to the AUX terminals. But an equalizer characteristic is not correct (further equalization is needed), and it is scarcely used together with high class apparatus.

Input Impedance

The PHONO input terminals (22) are coupled with a 3-step impedance selector (23) (30, 50, 100KΩ) on the rear panel. Except-

ing for a special low impedance type pick-up, almost all currently marketed pick-ups specify recommended load impedance as 30/100K ohms. It is furthermore an accepted fact that 50K ohm type pick-ups are predominant. It is known variation of the load impedance value effects to a greater extent frequency response. The chart given here clearly illustrates an example-with a low load impedance, treble output is cut while with a high load impedance a peak is caused in the treble range. Degree of such effect is not same with different pick-ups but generally a pick-up having a higher output impedance tends to be more deli-

cately influenced. It is therefore necessary that selection of a proper input impedance is made by this control.

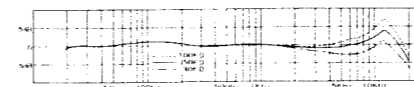

Step-up Transformer Unit for MC Type Phonograph Cartridges

This amplifier does not provide exclusive use connectors for a step-up transformer. However if input voltage step-up is desired, use of the LUX model 6521S pin-plug type step-up trans. unit can best be recom-

mended. This completely new step-up transformer is made to extremely compact size and features highly efficient performance. Fitting of this trans. to the amplifier is simple . . . insertion to the PHONO terminals. By use of this trans. low output level phonograph signals from an MC (moving coil) type cartridge can be boosted by 30 times.

The core is made of superpermalloy material to ensure superb frequency response. By-section winding coil construction and complete shielding provision for the core perfectly eliminate induced noise from external source.

Specifications (6521S trans unit, 2 pc. as a pair)

Primary end impedance	Less than 4 ohms
Secondary end impedance	More than 30Kohms
Step-up ratio	1 : 33
Frequency response	40 — 30,000Hz
Output voltage-distortion	500mv, 0.02%
Induced noise level	Less than -80dB/rn
Weight	12 grams

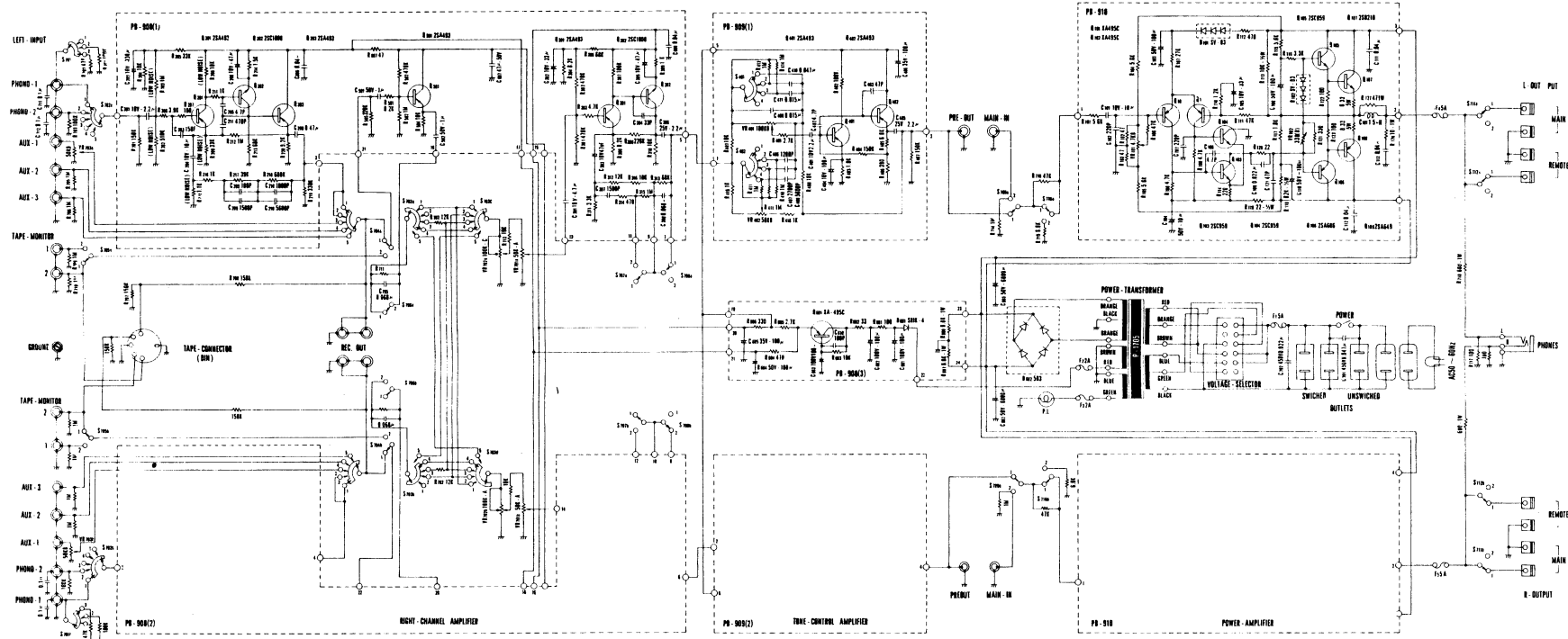

- | | | | |
|---|--|---|---|
| <p>LEFT INPUT</p> <p>PHONO-1</p> <p>PHONO-2</p> <p>AUX-1</p> <p>AUX-2</p> <p>AUX-3</p> <p>TAPE MONITOR</p> <p>GROUND</p> <p>TAPE MONITOR</p> <p>AUX-3</p> <p>AUX-2</p> <p>AUX-1</p> <p>PHONO-2</p> <p>PHONO-1</p> | <p>PB-900(1)</p> <p>PB-900(2)</p> <p>RIGHT CHANNEL AMPLIFIER</p> | <p>PB-900(3)</p> <p>TONE CONTROL AMPLIFIER</p> | <p>PB-910</p> <p>POWER AMPLIFIER</p> |
| <p>S 7014-7019 INPUT IMPEDANCE (1.100K 2.50K 3.30K)</p> <p>S 7021-7024, 7027-7028 FUNCTION (1 PHONO-1, 2 PHONO-2, 3 AUX-1, 4 AUX-2, 5 AUX-3)</p> <p>S 7031-7034, 7037-7038 MODE (1 L, 2 R, 3 L+R, 4 STEREO, 5 REVERSE)</p> <p>S 7041-7044 MONITOR (1 OFF, 2 ON)</p> <p>S 7051-7054 TAPE MONITOR SELECTOR (1 TAPE-2, 2 TAPE-1)</p> <p>S 7061-7064 LOW CUT FILTER (1 OFF, 2 ON)</p> <p>S 7071-7074 HIGH CUT FILTER (1 OFF, 2 ON)</p> <p>S 7081-7084 LOW BOOST (1 OFF, 2 ON)</p> <p>S 7091-7094 PRE-MAIN CONNECT (1 NORMAL, 2 SEPARATE)</p> <p>S 7101-7104 ATTENUATOR (1 OFF, 2 ON)</p> <p>S 7111-7114 MAIN SPEAKER (1 ON, 2 OFF)</p> <p>S 7121-7124 BEMIE SPEAKER (1 ON, 2 OFF)</p> <p>S 401 BASS (1 BFEAT, 2 150HZ, 3 300HZ, 4 600HZ)</p> <p>S 402 TREBLE (1 BFEAT, 2 6KHZ, 3 30KHZ, 4 1.5KHZ)</p> <p>VR 7011-7014 VOLUME CONT.</p> <p>VR 7021-7024 BALANCE CONT.</p> <p>VR 7031-7034 AUX-1 LEVEL SET.</p> <p>VR 401 BASS CONT.</p> <p>VR 402 TREBLE CONT.</p> | <p>S 7111-7114 MAIN SPEAKER (1 ON, 2 OFF)</p> <p>S 7121-7124 BEMIE SPEAKER (1 ON, 2 OFF)</p> <p>S 401 BASS (1 BFEAT, 2 150HZ, 3 300HZ, 4 600HZ)</p> <p>S 402 TREBLE (1 BFEAT, 2 6KHZ, 3 30KHZ, 4 1.5KHZ)</p> <p>VR 7011-7014 VOLUME CONT.</p> <p>VR 7021-7024 BALANCE CONT.</p> <p>VR 7031-7034 AUX-1 LEVEL SET.</p> <p>VR 401 BASS CONT.</p> <p>VR 402 TREBLE CONT.</p> | <p>VR 7011-7014 VOLUME CONT.</p> <p>VR 7021-7024 BALANCE CONT.</p> <p>VR 7031-7034 AUX-1 LEVEL SET.</p> <p>VR 401 BASS CONT.</p> <p>VR 402 TREBLE CONT.</p> | <p>UNLESS OTHERWISE SPECIFIED, ALL RESISTORS ARE IN OHM ± 10% 1/4W.</p> <p>ALL CAPACITORS ARE IN FARAD THERE MAY BE SLIGHT CHANGES IN THE ACTUAL SET.</p> <p>LINE VOLTAGE SELECTOR'S POSITION</p> |



SQ507X