

STEREO INTEGRATED AMPLIFIER

AX-540

SERVICE MANUAL

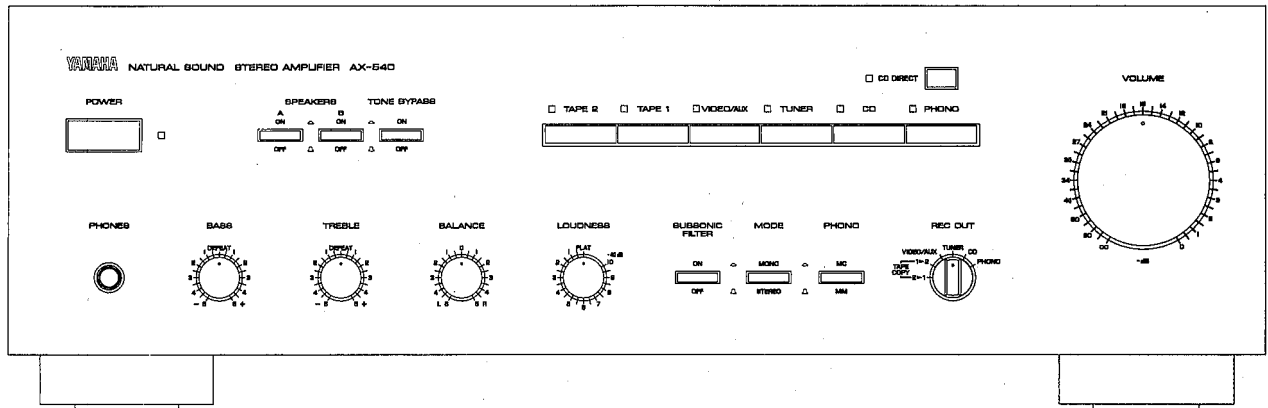

IMPORTANT NOTICE

This manual has been provided for the use of authorized YAMAHA Retailers and their service personnel. It has been assumed that basic service procedures inherent to the industry, and more specifically YAMAHA Products, are already known and understood by the users, and have therefore not been restated.

WARNING: Failure to follow appropriate service and safety procedures when servicing this product may result in personal injury, destruction of expensive components and failure of the product to perform as specified. For these reasons, we advise all YAMAHA product owners that all service required should be performed by an authorized YAMAHA Retailer or the appointed service representative.

IMPORTANT: The presentation or sale of this manual to any individual or firm does not constitute authorization, certification or recognition of any applicable technical capabilities, or establish a principle-agent relationship of any form.

The data provided is believed to be accurate and applicable to the unit(s) indicated on the cover. The research, engineering, and service departments of YAMAHA are continually striving to improve YAMAHA products. Modifications are, therefore, inevitable and specifications are subject to change without notice or obligation to retrofit. Should any discrepancy appear to exist, please contact the distributor's Service Division.

WARNING: Static discharges can destroy expensive components. Discharge any static electricity your body may have accumulated by grounding yourself to the ground buss in the unit (heavy gauge black wires connect to this buss).

IMPORTANT: Turn the unit OFF during disassembly and parts replacement. Recheck all work before you apply power to the unit.

CONTENTS

TO SERVICE PERSONNEL	1
REAR PANELS	1
SPECIFICATIONS	2
BLOCK DIAGRAM	3
INTERNAL VIEW	3
DISASSEMBLY PROCEDURES	4

ADJUSTMENTS	4
INTERCONNECT WIRING DIAGRAM	5
PRINTED CIRCUIT BOARD	6~13
SCHEMATIC DIAGRAM	14
PARTS LIST	15~23

100347

YAMAHA

YAMAHA CORPORATION
P.O. Box 1, Hamamatsu, Japan

2.0K-732 Printed in Japan '90.3

AX-540

■ TO SERVICE PERSONNEL

1. Critical Components Information.
Components having special characteristics are marked and must be replaced with parts having specifications equal to those originally installed.
2. Leakage Current Measurement (For 120V Model Only).
When service has been completed, it is imperative that you verify that all exposed conductive surfaces are properly insulated from supply circuits.
 - Meter impedance should be equivalent to 1500 ohm shunted by 0.15μF.
 - Leakage current must not exceed 0.5mA.
 - Be sure to test for leakage with the AC plug in both polarities.

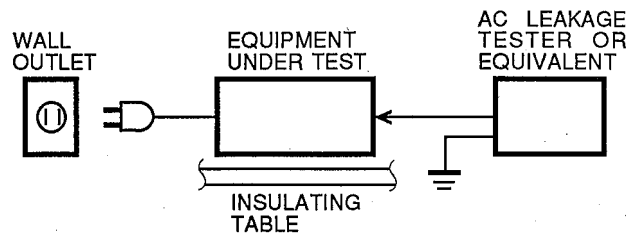

■ REAR PANELS

▼ Australian & British models

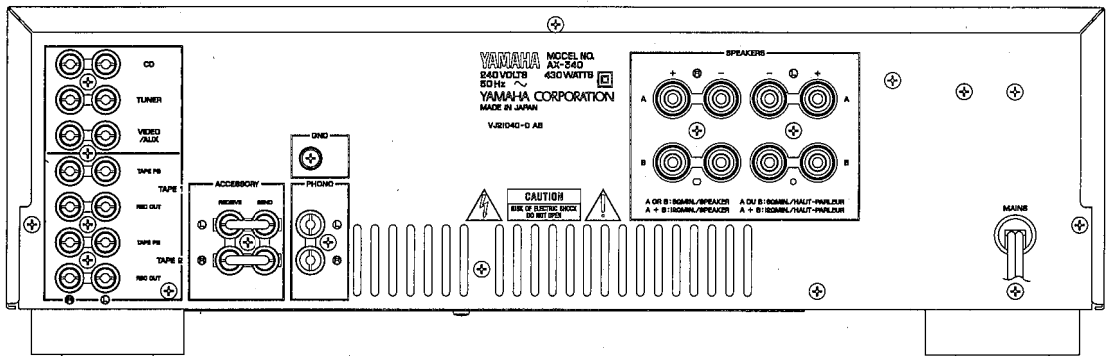

▼ European model

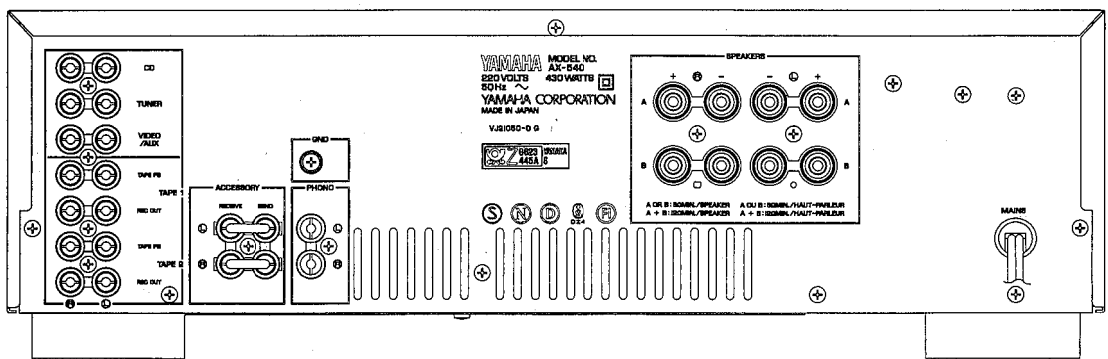

▼ General model

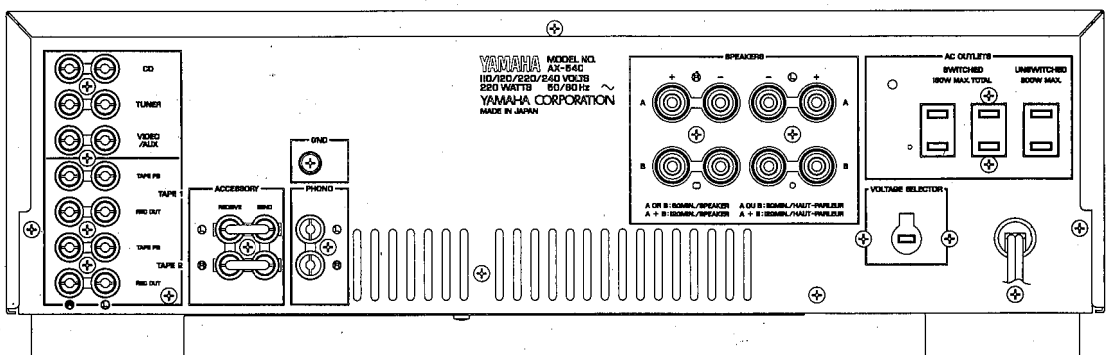

SPECIFICATIONS

AUDIO SECTION

Minimum RMS Output Power Per Channel	
20Hz~20kHz, 0.01% THD, 8Ω	85W
20Hz~20kHz, 0.015% THD, 6Ω (R model)	100W

Dynamic Power Per Channel (by IHF Dynamic Headroom measuring method)	
8Ω/6Ω/4Ω/2Ω (R model)	160W/200W/230W/250W
8Ω/6Ω/4Ω/2Ω (A, G, B models)	140W/170W/200W/220W

DIN Standard Output Power Per Channel (G model)	
1kHz, 1% THD, 4Ω	110W

Dynamic Headroom	
8Ω	2.75dB
6Ω	3.01dB

IEC Power (G model)	
1kHz, 0.01% THD, 8Ω	100W

Power Bandwidth	
0.03% THD, 42.5W, 8Ω	10Hz~50kHz

Damping Factor	
1kHz, 8Ω	≥80

Input Sensitivity / Impedance	
Phono MC	160μV/220Ω
Phono MM	2.5mV/47kΩ
CD etc	150mV/47kΩ

Input Sensitivity (New IHF) (R model)	
Phono MC	19μV
Phono MM	0.27mV
CD etc.	15.5mV

Maximum-Input Signal	
1kHz, 0.01% THD, Phono MC	10mV
1kHz, 0.01% THD, Phono MM	150mV

Output Level / Impedance	
Rec Out	150mV/220Ω

Headphone Jack Rated Output / Impedance	
0.01% THD, RL=8Ω	0.5V/120Ω

Frequency Response	
20Hz~20kHz, CD etc.	±0.5dB

RIAA Equalization Deviation	
20Hz~20kHz, Phono MC	±0.5dB
20Hz~20kHz, Phono MM	±0.3dB

Total Harmonic Distortion (20Hz~20kHz)	
Phono MC to Rec Out 3V	0.007%
Phono MM to Rec Out 3V	0.003%

Intermodulation Distortion	
CD etc. Rated Output/8Ω	0.01%

Signal to Noise Ratio (IHF-A-Network)	
Phono MC (500μV Input Shorted)	76dB
Phono MM (5mV Input Shorted)	92dB
CD etc. (Shorted)	102dB

Signal to Noise Ratio (New IHF)	
Phono MC	75dB
Phono MM	75dB
CD etc.	85dB

Residual Noise (IHF-A-Network)	
	140μV

Channel Separation (Vol. -30dB)	
Phono MC, MM Input Shorted 1kHz/10kHz	75dB/60dB
CD etc. Input 5.1kΩ terminated 1kHz/10kHz	75dB/60dB

Tone Control Characteristics

BASS	
boost/cut	±10dB (20Hz)
turnover frequency	350Hz
TREBLE	
boost/cut	±10dB (20kHz)
turnover frequency	3.5kHz

Filter Characteristics

Subsonic	15Hz, -12dB/oct
----------	-----------------

Continuous Loudness Control (Level related equalization)	
Attenuation	-40dB (1kHz)

Gain tracking error (0dB~-60dB)	2dB
--	-----

GENERAL

Power Supply	
A, B models	AC240V, 50Hz
G model	AC220V, 50Hz
R model	AC110/120/220/240V, 60/50Hz

Power Consumption	
A, B models	430W
G model	430W
R model	220W

AC Outlet (R models)	
Switched x 2	150W max.
Unswitched x 1	200W max.

Dimensions (WxHxD)	
	435 x 139 x 330.5 mm (17-1/8" x 5-1/2" x 13")

Weight	7.9kg (17 lbs 6 oz)
---------------	---------------------

*Specifications subject to change without notice.

- A Australian model
- G European model
- B British model
- R General model

DIMENSIONS

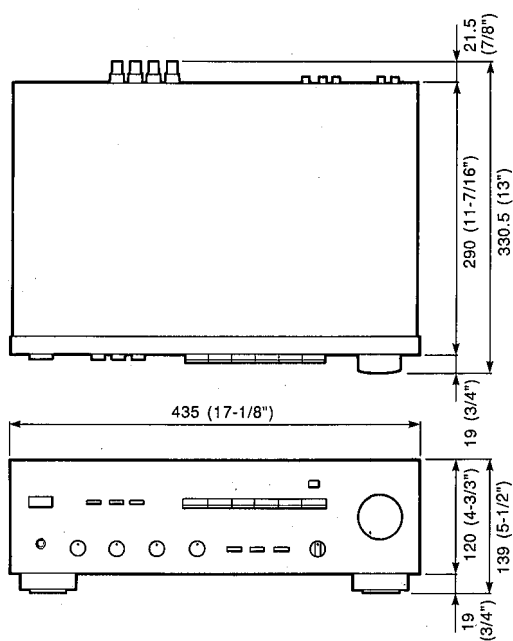

Unit : mm (inch)

AX-540

■ BLOCK DIAGRAM

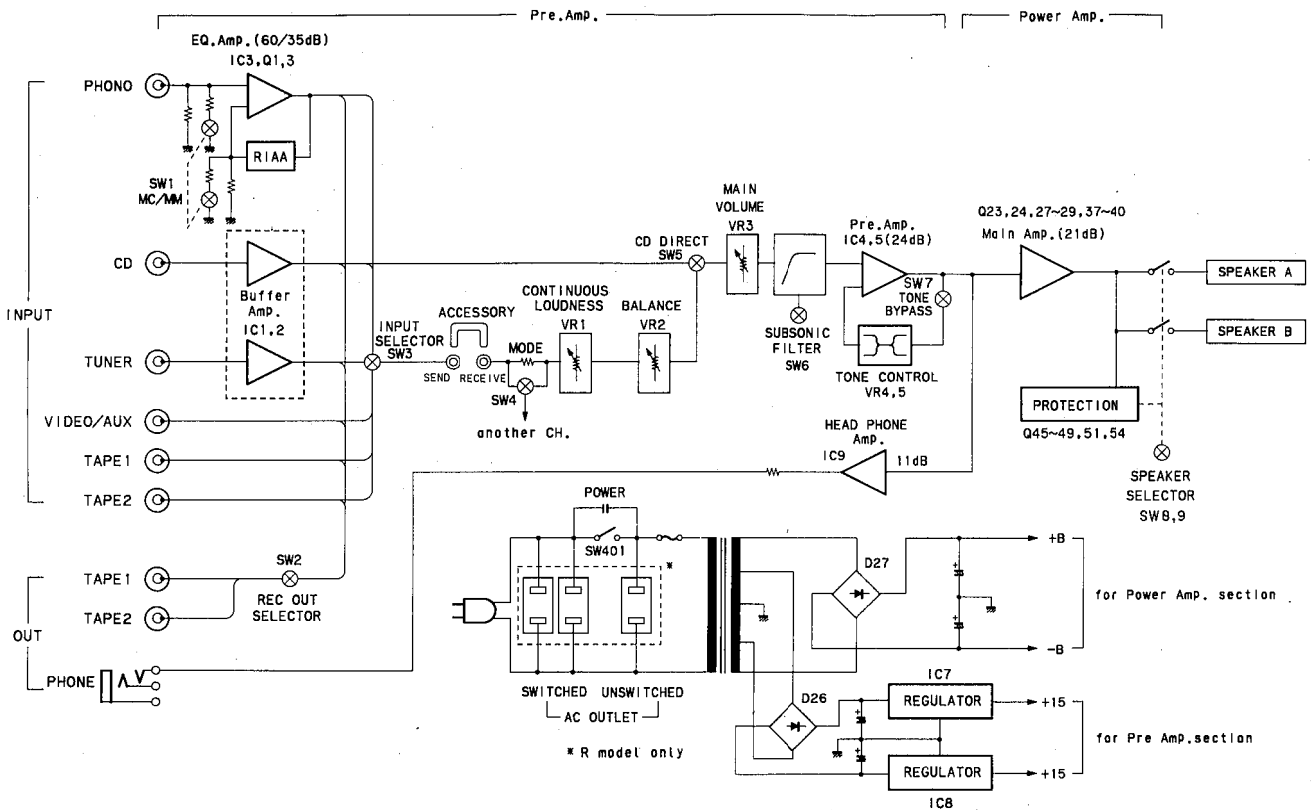

■ INTERNAL VIEW

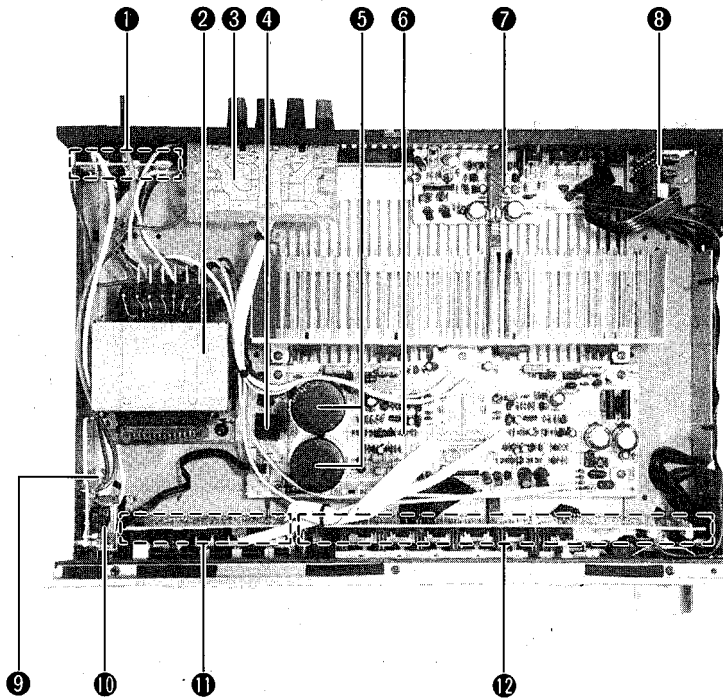

- ① SUB CIRCUIT BOARD (3)
- ② POWER TRANSFORMER
A, B models : XG096A00
G model : XG097A00
R model : XG095A00
- ③ SUB CIRCUIT BOARD (1)
- ④ DIODE BRIDGE : iH000870
- ⑤ ELECTROLYTIC CAP
12000 μ F 71V : VE442800
- ⑥ MAIN CIRCUIT BOARD (1)
- ⑦ MAIN CIRCUIT BOARD (3)
- ⑧ MAIN CIRCUIT BOARD (4)
- ⑨ FUSE
A, B, G models : KB002980 (T2.5A 250V)
R model : KB001300 (7.0A 250V)
- ⑩ POWER SWITCH
- ⑪ MAIN CIRCUIT BOARD (5)
- ⑫ MAIN CIRCUIT BOARD (2)

DISASSEMBLY PROCEDURES

(Remove parts in disassembly order as numbered.)

1. Removal of Top Cover

Remove 5 screws (①) in Fig. 1.

2. Removal of Bottom Cover

Remove 7 screws (②) in Fig. 1.

3. Removal of Front Panel

Remove 5 screws (③) in Fig. 1, and then the Front Panel forward.

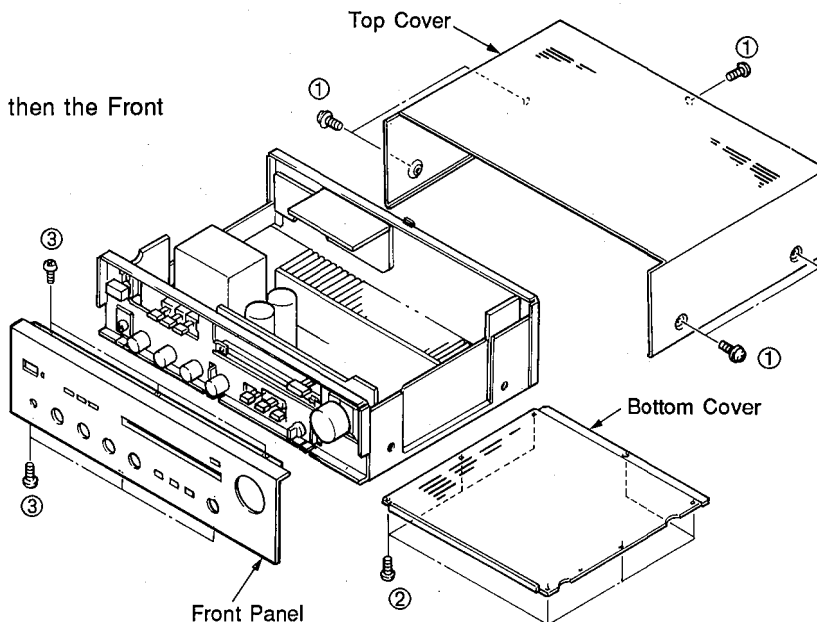

Fig. 1

ADJUSTMENTS

● Idling Current Adjustment

To stabilize operation of the amplifier, turn on the power in the no-signal state and wait two minutes before the adjustment.

Adjust VR7 (L ch) and VR8 (R ch) so that the voltage across the terminals of R188 or R191 and R203 or R205 come to 5mV±1mV DC.

	Test points	Adjustment points	Rating
L ch	R188 or R191	VR7	5mV±1mV DC
R ch	R203 or R205	VR8	5mV±1mV DC

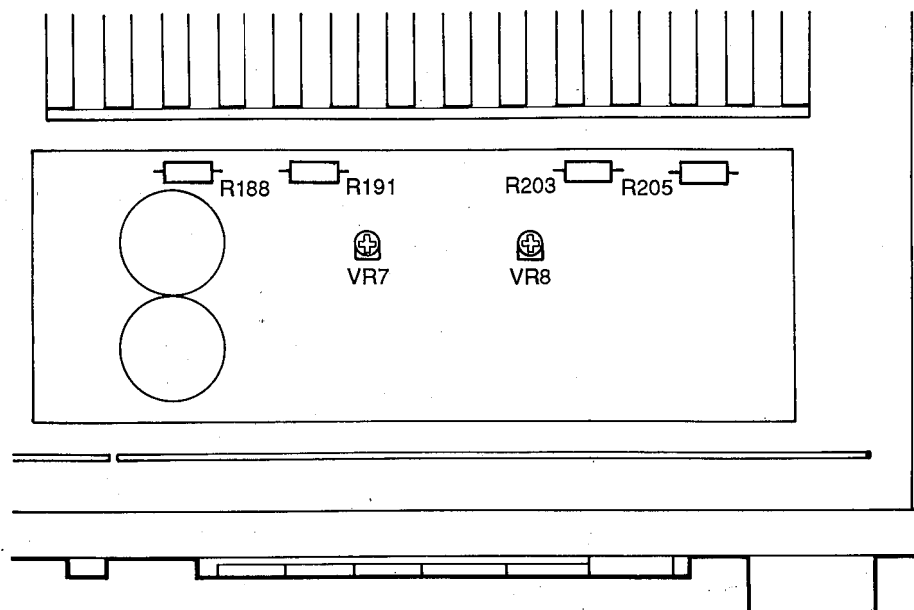

Fig. 2

PRINTED CIRCUIT BOARD (Foil side)

MAIN Circuit Board (1)

Note) 文字面 : Component side

Note : * Marked

	R, A, B	G
C130	OPEN	0.01/100
J261	OPEN	SHORT

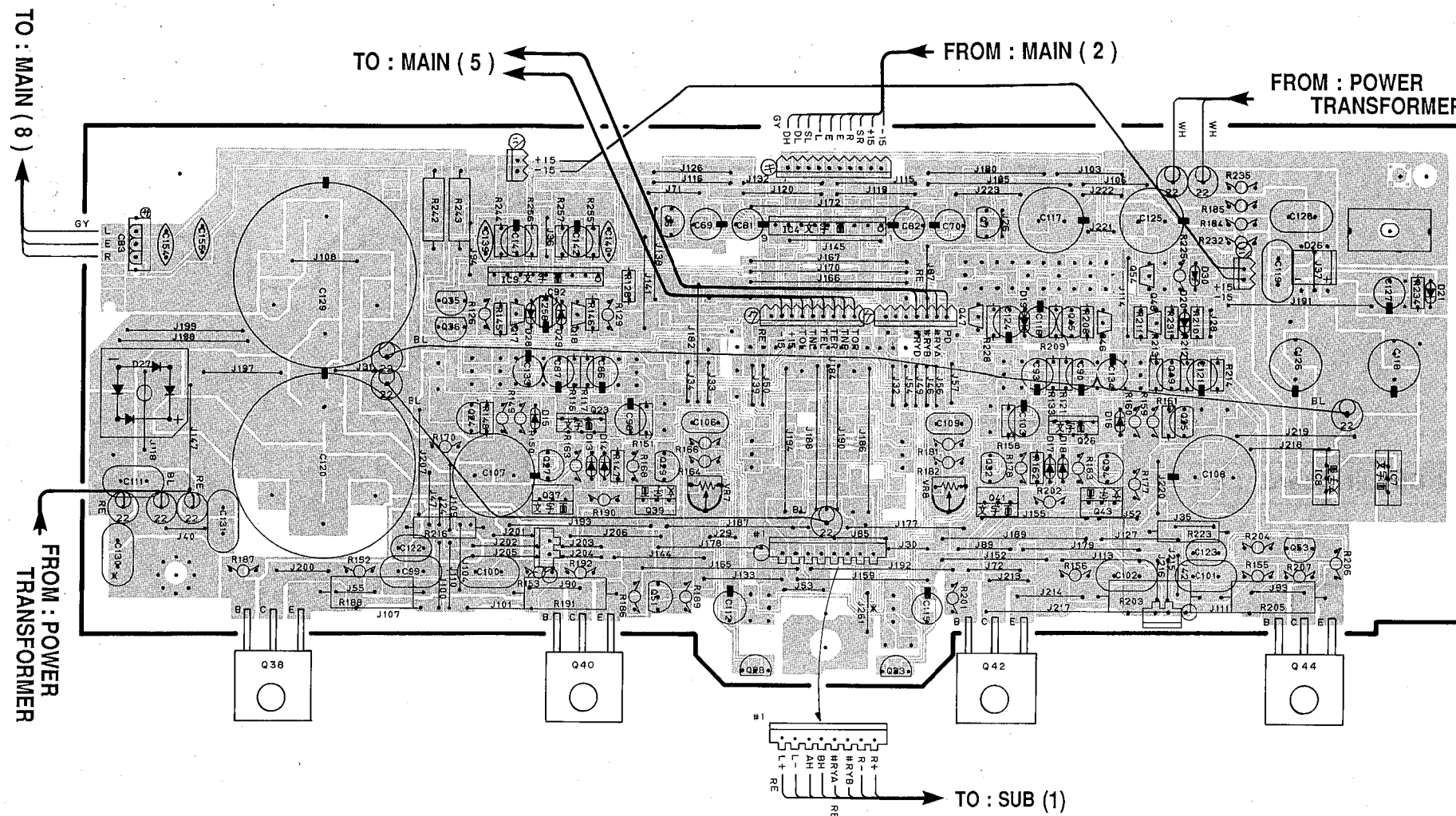

Note : * Marked

	R, A, B	G
C158, 159	OPEN	100P
C151, 152	OPEN	0.1

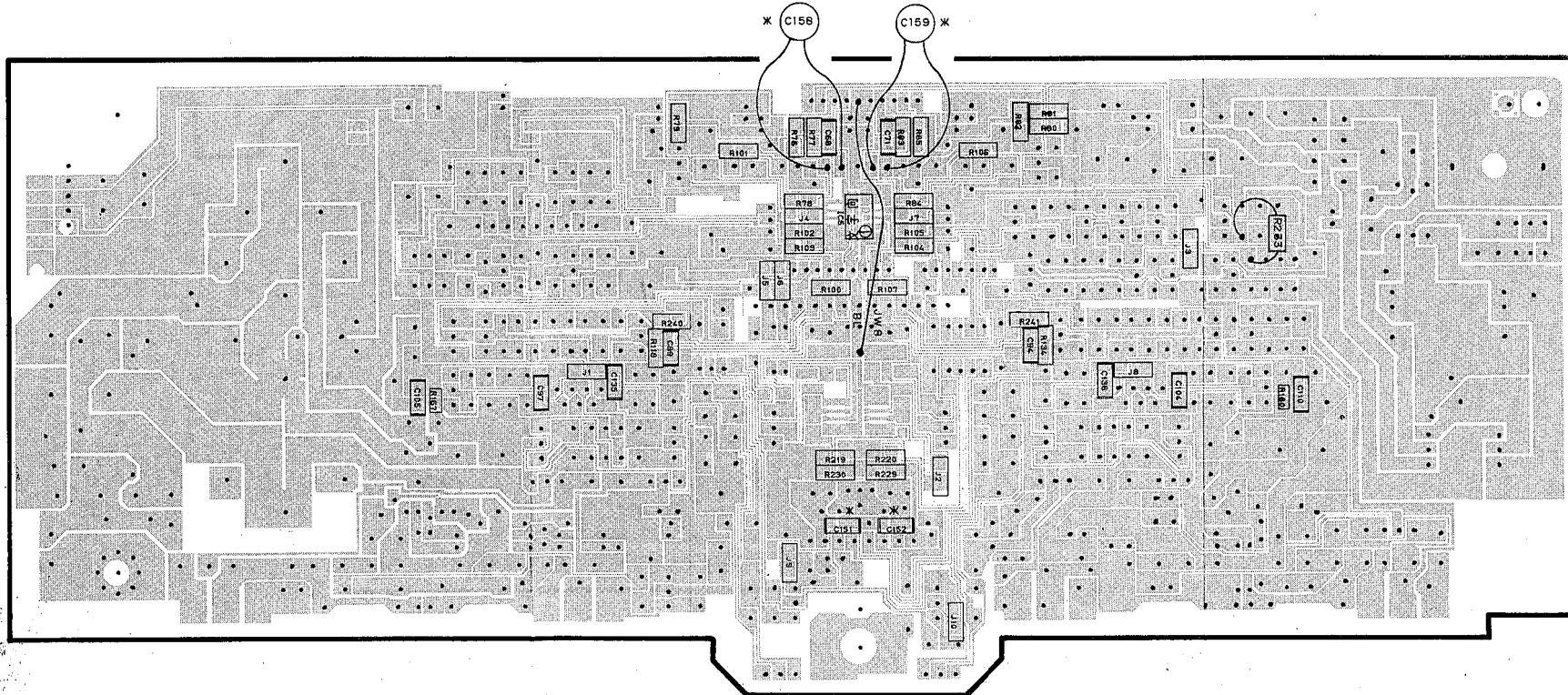

1

2

3

4

5

6

AX-540

■ PRINTED CIRCUIT BOARD (Foil side)

MAIN Circuit Board (2)

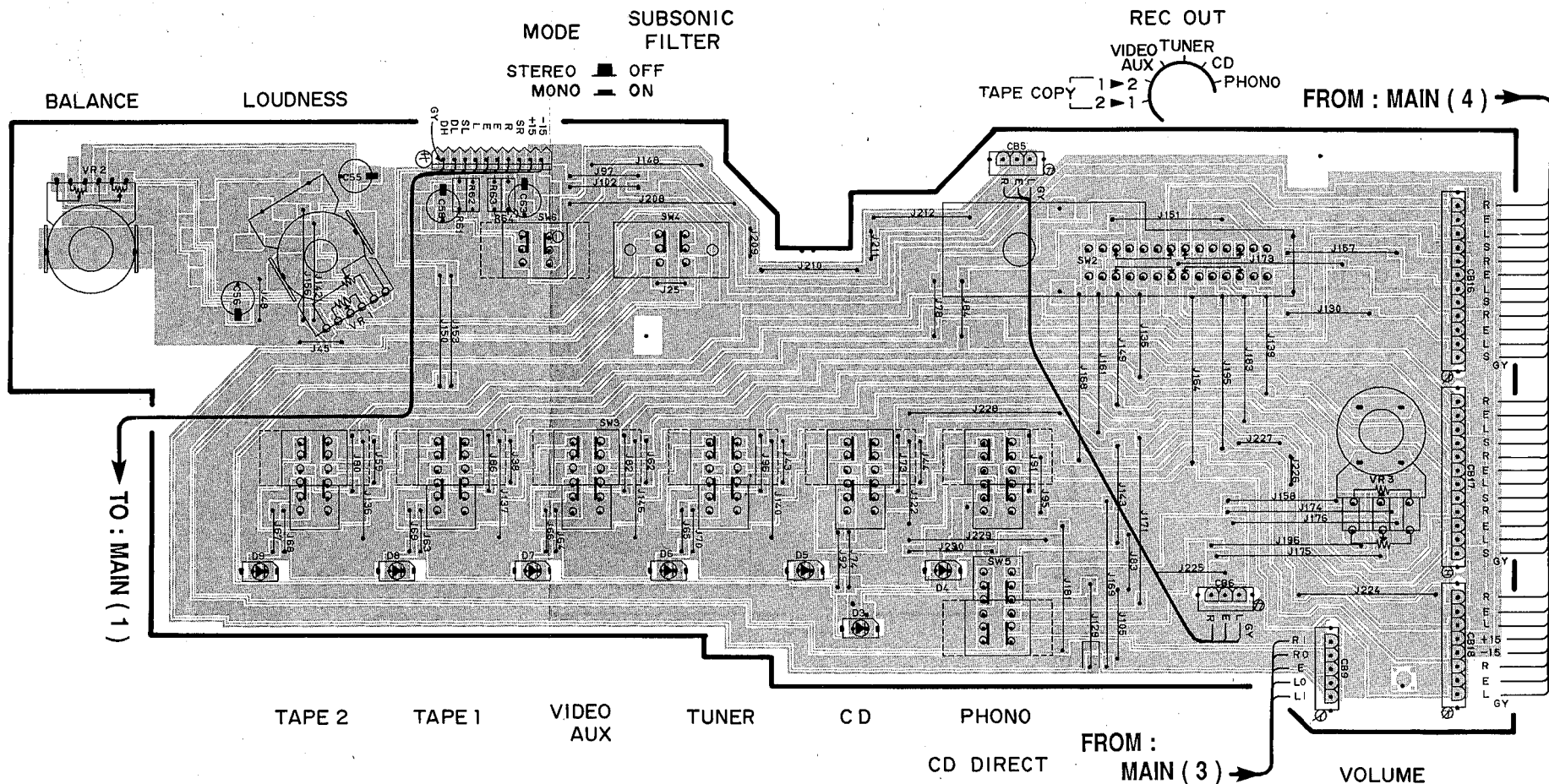

MAIN Circuit Board (8)

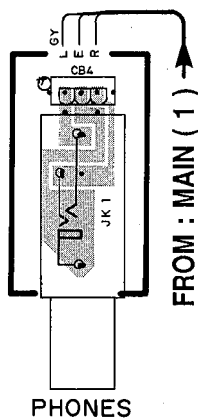

1

2

3

4

5

8

6

9

PRINTED CIRCUIT BOARD (Foil side)

Note) 文字面 : Component side

MAIN Circuit Board (3)

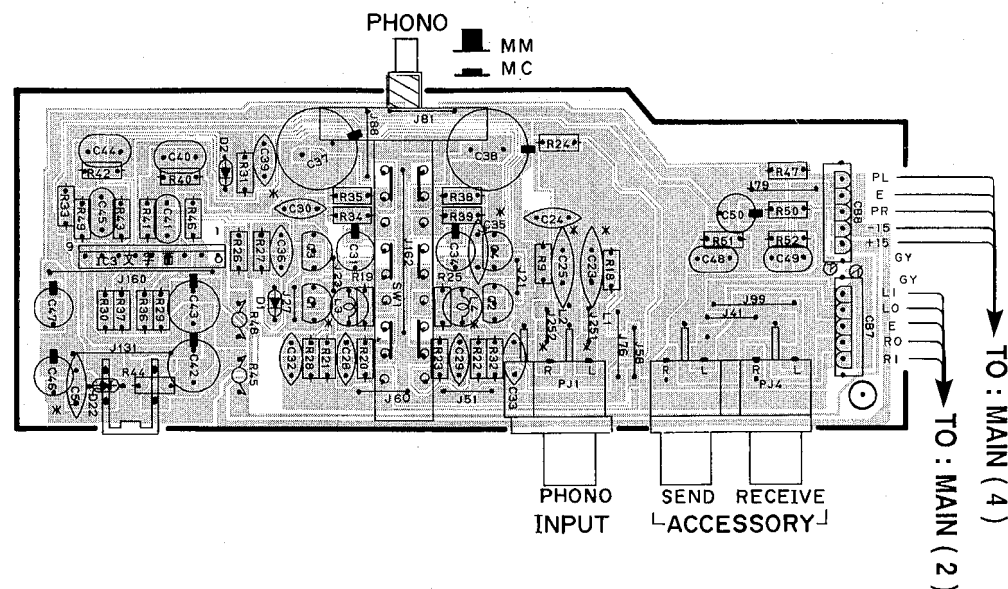

MAIN Circuit Board (4)

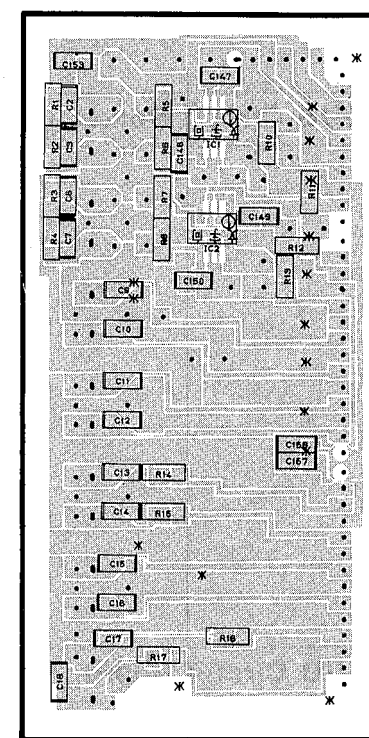
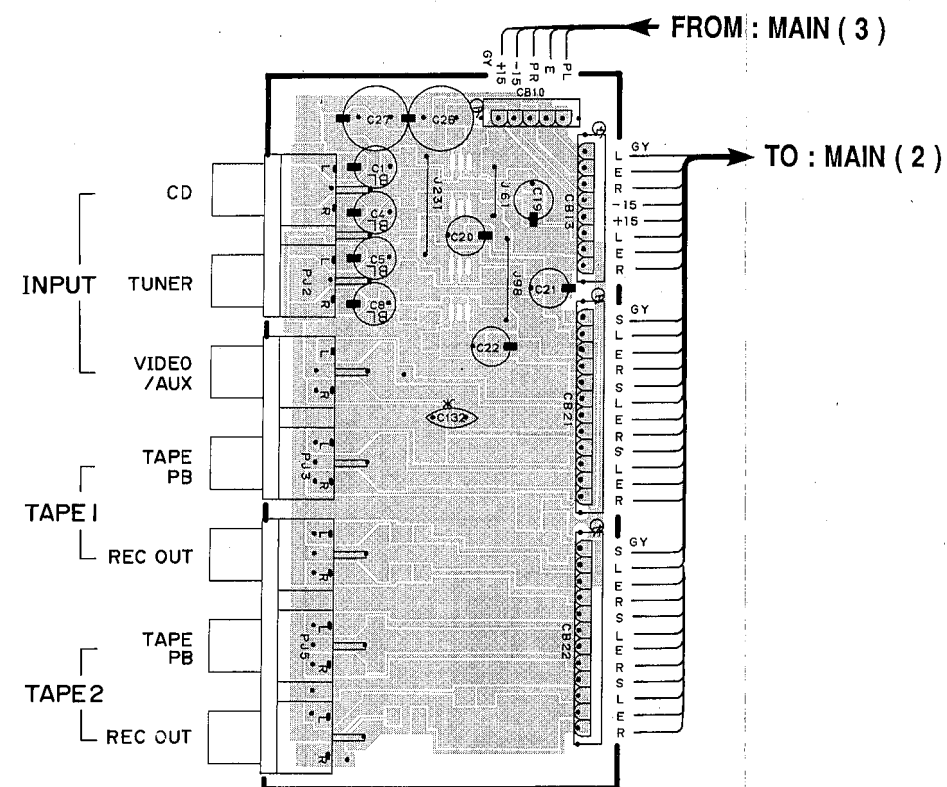

MAIN Circuit Board (5)

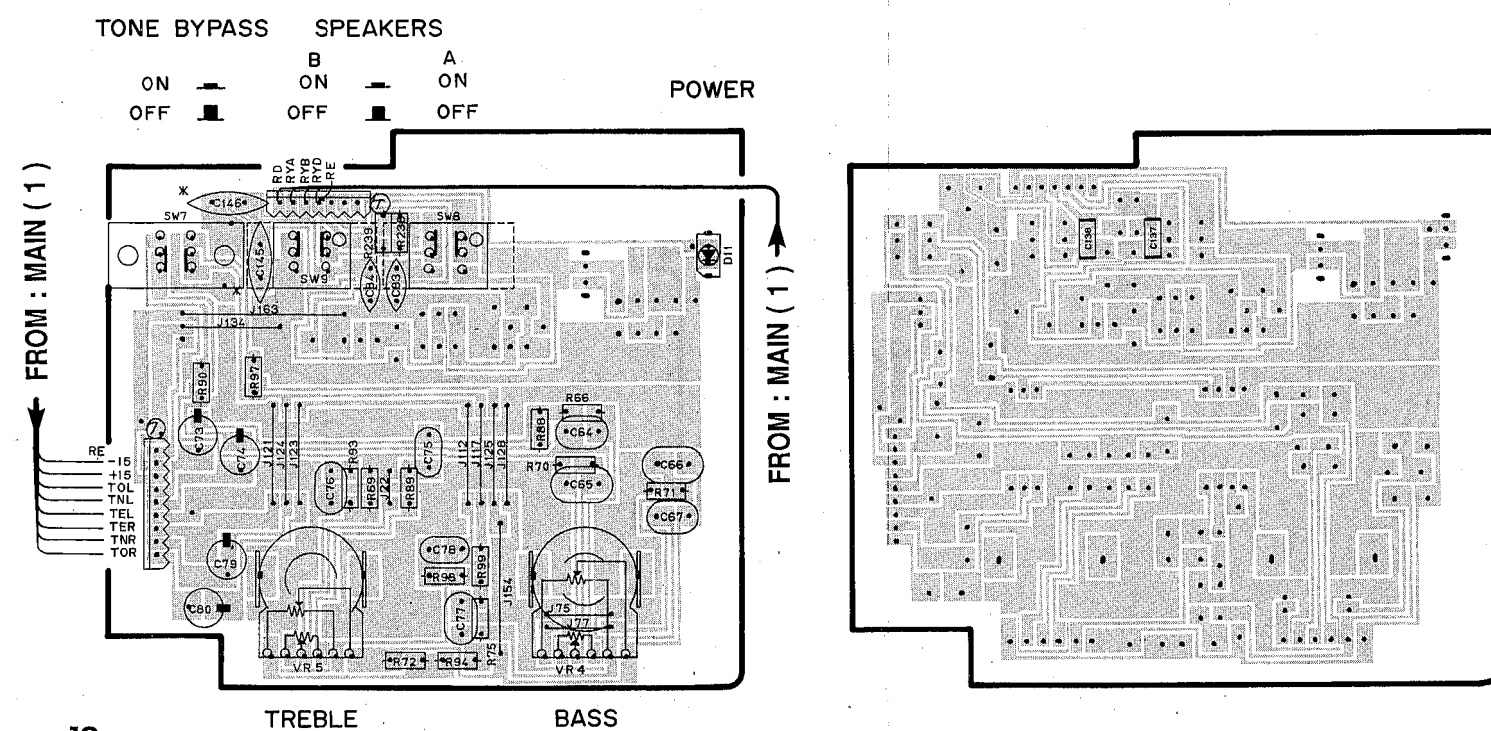

Note : * Marked

	R, A, B	G
C51	OPEN	5600P
C132	OPEN	0.01
C23, 25	OPEN	220P
J251, 252	SHORT	15μH
L3, 4	OPEN	220μH
C30, 35	OPEN	100P
C145, 146	OPEN	0.047

Note : * Marked

	R, A, B	G
C9~18	OPEN	470P
C153	OPEN	0.1
C156, 157	OPEN	100P
C147~150	OPEN	47P

1

2

3

4

5

6

PRINTED CIRCUIT BOARD (Foil side)

● R model

● A, B, G models

SUB Circuit Board (3)

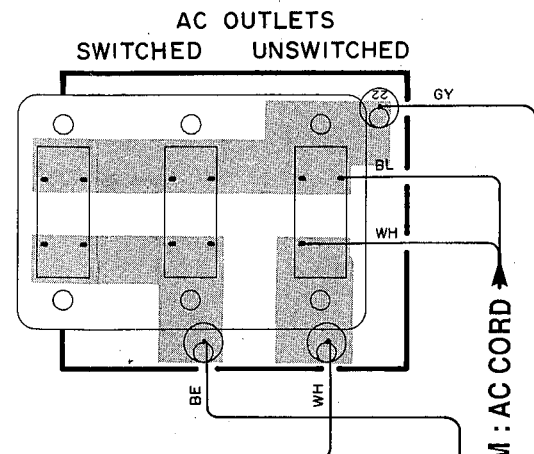

SUB Circuit Board (4)

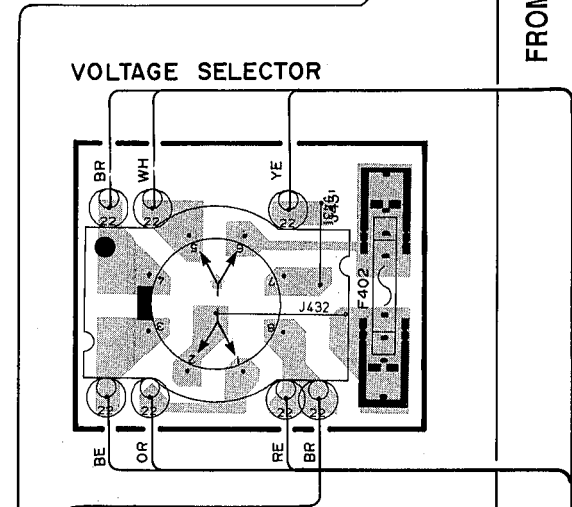

SUB Circuit Board (2)

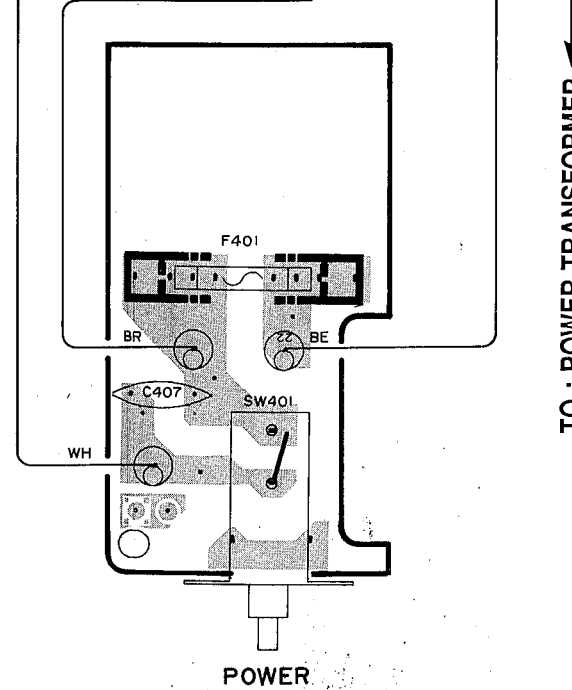

SUB Circuit Board (2)

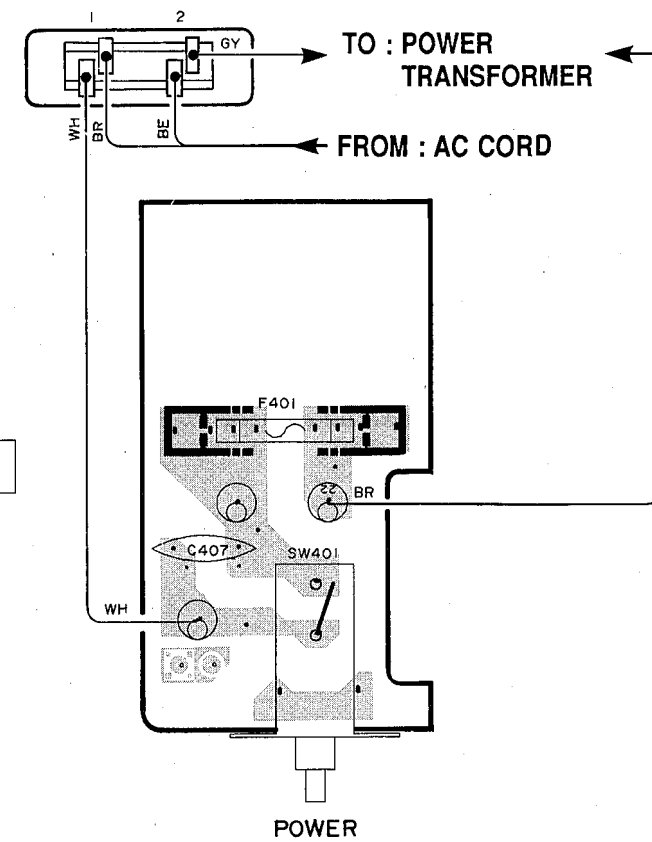

SUB Circuit Board (1)

Note : * Marked

	R, A, B	G
C401, 403, 404, 406	OPEN	0.01
C402, 405	OPEN	0.022
C408, 409	OPEN	0.047
R405, 406	OPEN	2.2

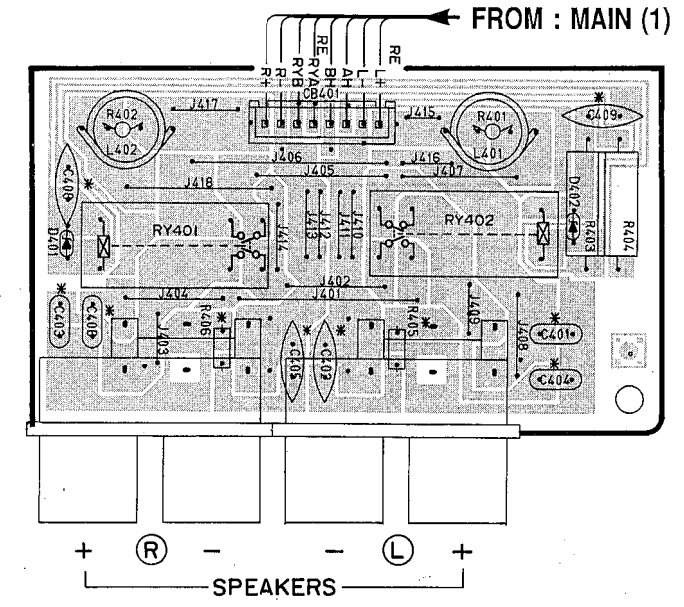

1
2
3
4
5
6

■ SCHEMATIC DIAGRAM

Q	IC	A.B	Q	R	A.B	Q
#1	C51	OPEN	5K00P	#14	C36	OPEN
#2	C192	OPEN	0.01	#15	C147-150	OPEN
#3	C23-25	OPEN	200P	#16	C111-131	OPEN
#4	R18-24	10	33	#17	C148-148	OPEN
#5	R77-81	100	180	#18	C402-405	OPEN
#6	L1-2	500P	15M	#19	C403-404	OPEN
#7	C32-33	200P	270P	#20	C401-406	OPEN
#8	L3-4	OPEN	220μH	#21	F401	7.0μ250V T.P. 5A2P50V
#9	R19-25	33	2.2K	#22	R405-406	OPEN
#10	D9-19	OPEN	470P	#23	SK401	1C40570
#11	C10	OPEN	0.01/100	#24	F402	3.5μ250V OPEN
#12	C151-153	OPEN	0.1			
#13	C38-39	1500P	2700P			

REMARKS	PARTS NAME	REMARKS	PARTS NAME
NO MARK	ELECTROLYTIC CAPACITOR	NO MARK	CARBON FILM RESISTOR (1/4W)
NO MARK	TANTALUM CAPACITOR	NO MARK	CARBON FILM RESISTOR (1/4W)
NO MARK	CERAMIC CAPACITOR	NO MARK	METAL FILM RESISTOR
NO MARK	POLYESTER FILM CAPACITOR	NO MARK	METAL PLATE RESISTOR
NO MARK	POLYSTYRENE FILM CAPACITOR	NO MARK	FIRE PROOF CARBON FILM RESISTOR
NO MARK	MICA CAPACITOR	NO MARK	CEMENT MOLDED RESISTOR
NO MARK	POLYPROPYLENE FILM CAPACITOR	NO MARK	SEMI-VARIABLE RESISTOR
NO MARK	SEMICONDUCTIVE CERAMIC CAPACITOR	NO MARK	CHIP RESISTOR

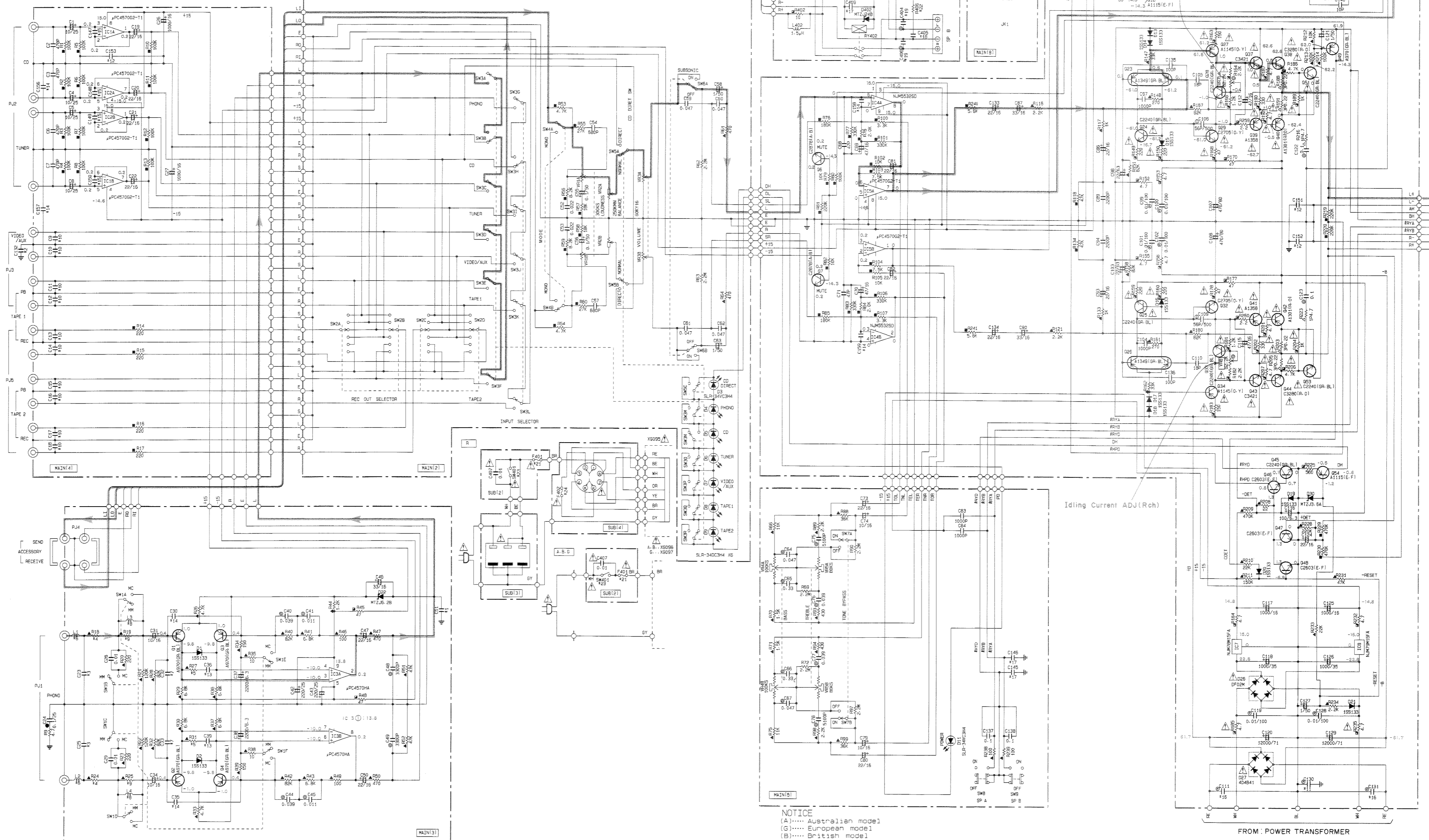

NOTICE
 (A)..... Australian model
 (G)..... European model
 (B)..... British model
 (R)..... General model
 (P)..... RP model

IC1, 2, 5 : μPC4570G2-T1
 Dual Ope-Amp

IC3 : μPC4570HA
 IC4 : NJM5532SD
 IC9 : NJM4556S-A
 Dual Ope-Amp

PIN CONNECTION DIAGRAM OF TRANSISTORS, DIODES AND ICs.

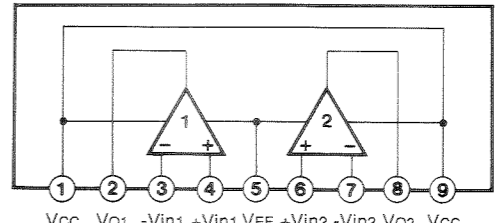
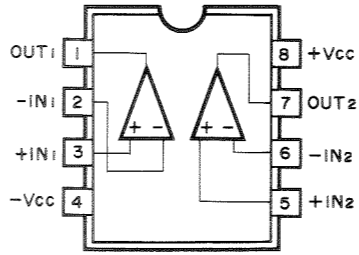
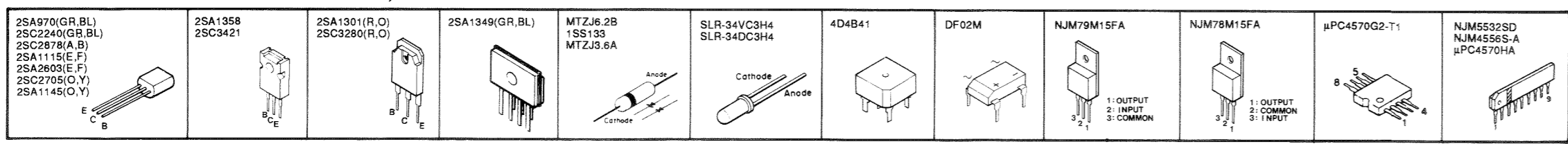

* All voltage are measured with a 10MΩ/DC electric volt meter.
 * Components having special characteristics are marked Δ and must be replaced with parts having specifications equal to those originally installed.
 * Schematic diagram is subject to change without notice.

PARTS LIST

■ WARNING

Components having special characteristics are marked \triangle and must be replaced with parts having specifications equal to those originally installed.

- Carbon resistors (1/6W or 1/4W) are not included in the ELECTRICAL PARTS List. For the parts No. of the carbon resistors, refer to P. 23.

AX-540

■ ELECTRICAL PARTS

Ref. NO.	PART NO.	Description			部 品 名	Remarks	Markets	ランク
	VJ243300	MAIN CIRCUIT BOARD			メイン シート		RAB	
	VJ243500	MAIN CIRCUIT BOARD			メイン シート		G	
	UA253330	MYLAR FILM CAP	3300pF	50V	マイラーコン	C48,49		
	FA153510	MYLAR FILM CAP	5100pF	50V	マイラーコン	C75,78		
	FA154110	MYLAR FILM CAP	0.011uF	50V	マイラーコン	C41,45		
	UA254390	MYLAR FILM CAP	0.039uF	50V	マイラーコン	C40,44,76,77		
	UA254470	MYLAR FILM CAP	0.047uF	50V	マイラーコン	C64,67		
	UA255100	MYLAR FILM CAP	0.1uF	50V	マイラーコン	C122,123		
	UA555330	MYLAR FILM CAP	0.33uF	50V	マイラーコン	C65,66		
	UT465100	POLYPROPYLENE FILM CAP	0.1uF	100V	PPコン	C111,131	G	
	UT454100	POLYPROPYLENE FILM CAP	0.01uF	100V	PPコン	C111,131	RAB	
	UT454100	POLYPROPYLENE FILM CAP	0.01uF	100V	PPコン	C99~102,119,128		
	UT454100	POLYPROPYLENE FILM CAP	0.01uF	100V	PPコン	C130	G	
	FG211100	CERAMIC CAP	10pF	50V	セラコン	C139,140		
	FG212100	CERAMIC CAP	100pF	50V	セラコン	C30,35,158,159	G	
	FG212220	CERAMIC CAP	220pF	50V	セラコン	C23,25	G	
	FG212220	CERAMIC CAP	220pF	50V	セラコン	C32,33	RAB	
	FG212270	CERAMIC CAP	270pF	50V	セラコン	C32,33	G	
	FG213100	CERAMIC CAP	1000pF	50V	セラコン	C83,84		
	FG213150	CERAMIC CAP	1500pF	50V	セラコン	C36,39	RAB	
	FG713270	CERAMIC CAP	2700pF	50V	セラコン	C36,39	G	
	FG213560	CERAMIC CAP	5600pF	50V	セラコン	C51	G	
	FG244100	CERAMIC CAP	0.01uF	50V	セラコン	C28,29,154,155		
	FG244100	CERAMIC CAP	0.01uF	50V	セラコン	C132	G	
	FG244470	CERAMIC CAP	0.047uF	50V	セラコン	C145,146	G	
	UD111180	CHIP MULTILAYER CERAMIC CAP	18pF	50V	チップ積層セラコン	C105,110		
	UD111470	CHIP MULTILAYER CERAMIC CAP	47pF	50V	チップ積層セラコン	C68,71		
	UD111470	CHIP MULTILAYER CERAMIC CAP	47pF	50V	チップ積層セラコン	C147~150	G	
	UD112100	CHIP MULTILAYER CERAMIC CAP	100pF	50V	チップ積層セラコン	C135,136		
	UD112100	CHIP MULTILAYER CERAMIC CAP	100pF	50V	チップ積層セラコン	C156,157	G	
	UD112470	CHIP MULTILAYER CERAMIC CAP	470pF	50V	チップ積層セラコン	C2,3,6,7		
	UD112470	CHIP MULTILAYER CERAMIC CAP	470pF	50V	チップ積層セラコン	C9~18	G	
	UD112680	CHIP MULTILAYER CERAMIC CAP	680pF	50V	チップ積層セラコン	C54,57		
	UD113100	CHIP MULTILAYER CERAMIC CAP	1000pF	50V	チップ積層セラコン	C97,104		
	UD113220	CHIP MULTILAYER CERAMIC CAP	2200pF	50V	チップ積層セラコン	C89,94		
	UD114220	CHIP MULTILAYER CERAMIC CAP	0.022uF	50V	チップ積層セラコン	C52,53		
	UD114470	CHIP MULTILAYER CERAMIC CAP	0.047uF	50V	チップ積層セラコン	C59~62		
	UD115100	CHIP MULTILAYER CERAMIC CAP	0.1uF	50V	チップ積層セラコン	C137,138		
	UD115100	CHIP MULTILAYER CERAMIC CAP	0.1uF	50V	チップ積層セラコン	C151~153	G	
	VG288000	ELECTROLYTIC CAP	1000uF	16V	ケミコン	C26,27	RABG	
	Vi841000	ELECTROLYTIC CAP	100uF	6.3V	ケミコン	C116		
	Vi842200	ELECTROLYTIC CAP	10uF	16V	ケミコン	C31,34,74,79,92,141,142		
	Vi842300	ELECTROLYTIC CAP	22uF	16V	ケミコン	C47,50,73,80~82,124		
	Vi842400	ELECTROLYTIC CAP	33uF	16V	ケミコン	C46		
	Vi843600	ELECTROLYTIC CAP	220uF	25V	ケミコン	C42,43		
	Vi844500	ELECTROLYTIC CAP	0.1uF	50V	ケミコン	C55,56		
	Vi844900	ELECTROLYTIC CAP	1uF	50V	ケミコン	C121,127		
	Vi846000	ELECTROLYTIC CAP	22uF	63V	ケミコン	C98,103		
	UW819220	ELECTROLYTIC CAP	2200uF	6.3V	ケミコン	C37,38		

*New Parts (新規部品)

ランク : Japan only

AX-540

Ref. NO.	PART NO.	Description			部 品 名	Remarks	Markets	ランク
	UJ139100	ELECTROLYTIC CAP	1000uF	16V	ケミコン	C117,125		
	UJ159100	ELECTROLYTIC CAP	1000uF	35V	ケミコン	C118,126		
	VE393700	ELECTROLYTIC CAP	47uF	16V	ケミコン	C112,115		
	VH620000	ELECTROLYTIC CAP	22uF	16V	ケミコン	C86,93,133,134		
	VH620100	ELECTROLYTIC CAP	33uF	16V	ケミコン	C87,90		
	VH620200	ELECTROLYTIC CAP	47uF	16V	ケミコン	C69,70		
	VH621700	ELECTROLYTIC CAP	1uF	50V	ケミコン	C58,63		
	VE017700	ELECTROLYTIC CAP	22uF	16V	ケミコン	C19~22		
	VJ483500	ELECTROLYTIC CAP	470uF	80V	ケミコン	C107,108		
	FZ005420	ELECTROLYTIC CAP	10uF	25V	ケミコン	C1,4,5,8		
	VE442800	ELECTROLYTIC CAP	12000uF	71V	ケミコン	C120,129		
	FU351560	MICA CAP	56pF	500V	マイカコン	C106,109		
	FZ004130	SEMICONDUCTIVE CERAMIC CAP	0.1uF	25V	半導体セラコン	C24		
	VA983500	COIL	15uH		コイル	L1,2	G	
	VA983600	COIL	220uH		コイル	L3,4	G	
	HU574100	METAL FILM RESISTOR	10Ω	1/4W	金属被膜抵抗	R35,38		
	HU574100	METAL FILM RESISTOR	10Ω	1/4W	金属被膜抵抗	R18,24	RAB	
	HU594330	METAL FILM RESISTOR	33Ω	1/4W	金属被膜抵抗	R18,24	G	
	HU594220	METAL FILM RESISTOR	22Ω	1/4W	金属被膜抵抗	R208		
	HU594330	METAL FILM RESISTOR	33Ω	1/4W	金属被膜抵抗	R19,25	RAB	
	HU576220	METAL FILM RESISTOR	2.2KΩ	1/4W	金属被膜抵抗	R19,25	G	
	HU595100	METAL FILM RESISTOR	100Ω	1/4W	金属被膜抵抗	R46,49,238,239		
	HU595100	METAL FILM RESISTOR	100Ω	1/4W	金属被膜抵抗	R27,31	RAB	
	HU575180	METAL FILM RESISTOR	180Ω	1/4W	金属被膜抵抗	R27,31	G	
	HU595150	METAL FILM RESISTOR	150Ω	1/4W	金属被膜抵抗	R34,39		
	HU575220	METAL FILM RESISTOR	220Ω	1/4W	金属被膜抵抗	R20,23		
	HU575270	METAL FILM RESISTOR	270Ω	1/4W	金属被膜抵抗	R148,161		
	HU575430	METAL FILM RESISTOR	430Ω	1/4W	金属被膜抵抗	R93,94		
	HU575470	METAL FILM RESISTOR	470Ω	1/4W	金属被膜抵抗	R47,50,61,64		
	HU596100	METAL FILM RESISTOR	1KΩ	1/4W	金属被膜抵抗	R117,133		
	HU576120	METAL FILM RESISTOR	1.2KΩ	1/4W	金属被膜抵抗	R44		
	HU576150	METAL FILM RESISTOR	1.5KΩ	1/4W	金属被膜抵抗	R70,71		
	HU576220	METAL FILM RESISTOR	2.2KΩ	1/4W	金属被膜抵抗	R89,98,116,121,234		
	HU576470	METAL FILM RESISTOR	4.7KΩ	1/4W	金属被膜抵抗	R26,33		
	HU576680	METAL FILM RESISTOR	6.8KΩ	1/4W	金属被膜抵抗	R29,30,36,37,41,43		
	HU597100	METAL FILM RESISTOR	10KΩ	1/4W	金属被膜抵抗	R128,212,256~258		
	HU577110	METAL FILM RESISTOR	11KΩ	1/4W	金属被膜抵抗	R66,75		
	HU577220	METAL FILM RESISTOR	22KΩ	1/4W	金属被膜抵抗	R210,233		
	HU577240	METAL FILM RESISTOR	24KΩ	1/4W	金属被膜抵抗	R244,255		
	HU577330	METAL FILM RESISTOR	33KΩ	1/4W	金属被膜抵抗	R147,162		
	HU577360	METAL FILM RESISTOR	36KΩ	1/4W	金属被膜抵抗	R88,99		
	HU577470	METAL FILM RESISTOR	47KΩ	1/4W	金属被膜抵抗	R51,52,231		
	HU577820	METAL FILM RESISTOR	82KΩ	1/4W	金属被膜抵抗	R28,32,40,42,151,158		
	HU598100	METAL FILM RESISTOR	100KΩ	1/4W	金属被膜抵抗	R213,214		
	HU578120	METAL FILM RESISTOR	120KΩ	1/4W	金属被膜抵抗	R21,22		
	HU578150	METAL FILM RESISTOR	150KΩ	1/4W	金属被膜抵抗	R211		
	HU598220	METAL FILM RESISTOR	220KΩ	1/4W	金属被膜抵抗	R145,146,228		
	HU578470	METAL FILM RESISTOR	470KΩ	1/4W	金属被膜抵抗	R209		
	RA255220	CHIP RESISTOR	220Ω	1/8W	チップ抵抗	R14~17		
	RA256200	CHIP RESISTOR	2KΩ	1/8W	チップ抵抗	R78,84		

*New Parts (新規部品)

ランク : Japan only

Ref. NO.	PART NO.	Description	部 品 名		Remarks	Markets	ランク
	RA256330	CHIP RESISTOR	3.3K Ω	1/8W	チップ抵抗	R100,107	
	RA256470	CHIP RESISTOR	4.7K Ω	1/8W	チップ抵抗	R53,54	
	RA256560	CHIP RESISTOR	5.6K Ω	1/8W	チップ抵抗	R240,241	
	RA256750	CHIP RESISTOR	7.5K Ω	1/8W	チップ抵抗	R103,104	
	RA256820	CHIP RESISTOR	8.2K Ω	1/8W	チップ抵抗	R56,59	
	RA257100	CHIP RESISTOR	10K Ω	1/8W	チップ抵抗	R79,82,102,105	
	RA257180	CHIP RESISTOR	18K Ω	1/8W	チップ抵抗	R57,58	
	RA257270	CHIP RESISTOR	27K Ω	1/8W	チップ抵抗	R55,60	
	RA257470	CHIP RESISTOR	47K Ω	1/8W	チップ抵抗	R118,134	
	RA258100	CHIP RESISTOR	100K Ω	1/8W	チップ抵抗	R1~8,10~13,80	
	RA258180	CHIP RESISTOR	180K Ω	1/8W	チップ抵抗	R76,85	
	RA258220	CHIP RESISTOR	220K Ω	1/8W	チップ抵抗	R81,219,220	
	RA258330	CHIP RESISTOR	330K Ω	1/8W	チップ抵抗	R77,83,101,106	
	RA258470	CHIP RESISTOR	470K Ω	1/8W	チップ抵抗	R229,230	
	VH257000	CHIP RESISTOR	82K Ω	1/16W	チップ抵抗	R167,180	
	HV453220	FLAME PROOF CARBON RESISTOR	2.2 Ω	1/4W	不燃化カーボン抵抗	R259,260	
	HV453470	FLAME PROOF CARBON RESISTOR	4.7 Ω	1/4W	不燃化カーボン抵抗	R152,153,155,156,184, 185,187,192,201,207, 232,235	
	HV454470	FLAME PROOF CARBON RESISTOR	47 Ω	1/4W	不燃化カーボン抵抗	R45,48,168,170,177,178	
	HV454560	FLAME PROOF CARBON RESISTOR	56 Ω	1/4W	不燃化カーボン抵抗	R126,129	
	HV455150	FLAME PROOF CARBON RESISTOR	150 Ω	1/4W	不燃化カーボン抵抗	R163,183	
	HV455220	FLAME PROOF CARBON RESISTOR	220 Ω	1/4W	不燃化カーボン抵抗	R149,150,159,160	
	HV455330	FLAME PROOF CARBON RESISTOR	330 Ω	1/4W	不燃化カーボン抵抗	R190,202	
	HV455560	FLAME PROOF CARBON RESISTOR	560 Ω	1/4W	不燃化カーボン抵抗	R225	
	HV456100	FLAME PROOF CARBON RESISTOR	1K Ω	1/4W	不燃化カーボン抵抗	R189,204	
	HV456120	FLAME PROOF CARBON RESISTOR	1.2K Ω	1/4W	不燃化カーボン抵抗	R166,181	
	HV456220	FLAME PROOF CARBON RESISTOR	2.2K Ω	1/4W	不燃化カーボン抵抗	R164,182	
	HV456470	FLAME PROOF CARBON RESISTOR	4.7K Ω	1/4W	不燃化カーボン抵抗	R186,206	
	VD952400	METAL OXIDE RESISTOR	0.22 Ω	3W	酸化金属被膜抵抗	R188,191,203,205	
	HL313470	METAL OXIDE RESISTOR	4.7 Ω	1W	酸化金属被膜抵抗	R216,223	
	HL315120	METAL OXIDE RESISTOR	120 Ω	1W	酸化金属被膜抵抗	R242,243	
	iG077410	IC	NJM4556S-A		IC	IC9	
	XB247001	IC	uPC4570HA		IC	IC3	
	XC632001	IC	NJM5532SD		IC	IC4	
	XF291A00	IC	uPC4570G2-T1		IC	IC1,2,5	
	XE584A00	IC	NJM78M15FA		IC	IC7	
	XG505A00	IC	NJM79M15FA		IC	IC8	
	VC237800	ROTARY SWITCH	SRRZU4		ロータリーSW	SW2	
	VC176700	PUSH SWITCH	4-2		プッシュSW	SW5	
	VC245500	PUSH SWITCH	2-2	SPEC12036B	プッシュSW	SW6,8,9	
	VC369900	PUSH SWITCH	6-2	SUF19	プッシュSW	SW1	
	VD156300	PUSH SWITCH	2-2	SPEC12	プッシュSW	SW4	
	VH584000	PUSH SWITCH	2-2	SPEC12	プッシュSW	SW7	
	VC237700	PUSH SWITCH	4-2	SPEC616	プッシュSW	SW3	
	LB202290	PIN JACK	2P	T5856-A	ピンジャック	PJ1	
	LB401030	PIN JACK	4P	T5857-A	ピンジャック	PJ3,4	
	LB401040	PIN JACK	4P		ピンジャック	PJ2	
	LB606090	PIN JACK	6P	T5916-A	ピンジャック	PJ5	
	LB301720	PHONES JACK			ヘッドホーンジャック	JK1	

*New Parts (新規部品)

ランク : Japan only

Ref. NO.	PART NO.	Description	部 品 名	Remarks	Markets	ランク
	VB861200	PRE-SET POTENTIOMETER	B2.2KΩ	半固定VR	VR7,8	
	VC237100	POTENTIOMETER	MN250KΩ	二連ロータリーVR	VR2	
	VC237200	POTENTIOMETER	80KΩ	二連ロータリーVR	VR5	
	VC237300	POTENTIOMETER	100KΩ	二連ロータリーVR	VR4	
	VJ268300	POTENTIOMETER	Y60KΩ	二連ロータリーVR	VR3	
	VC297400	POTENTIOMETER	300KΩ	二連ロータリーVR	VR1	
	iA097000	TRANSISTOR	2SA970 GR,BL	トランジスタ	Q1~4,49	
	iA111510	TRANSISTOR	2SA1115 E,F	トランジスタ	Q17,18,54	
	iA114500	TRANSISTOR	2SA1145 O,Y	トランジスタ	Q27,34	△
	iC224000	TRANSISTOR	2SC2240 GR,BL	トランジスタ	Q24,25,28,33,45,51,53	△
	iC260320	TRANSISTOR	2SC2603 E,F	トランジスタ	Q46~48	
	iC270500	TRANSISTOR	2SC2705 O,Y	トランジスタ	Q29,32	△
	iC287800	TRANSISTOR	2SC2878 A,B	トランジスタ	Q6,7,35,36	
	iX608510	TRANSISTOR	2SA1358	トランジスタ	Q39,41	△
	iX608520	TRANSISTOR	2SC3421	トランジスタ	Q37,43	△
	iA134900	TRANSISTOR	2SA1349 GR,BL	トランジスタ	Q23,26	
	iF003450	DIODE	1SS133	ダイオード	D1,2,13~21,28,29	
	iH001160	DIODE BRIDGE	4D4B41	ダイオードブリッジ	D27	△
	VE367900	DIODE BRIDGE	DF02M	ダイオードブリッジ	D26	△
	VG438000	ZENER DIODE	MTZJ6.2B	ツェナーダイオード	D22	
	VG436200	ZENER DIODE	MTZJ3.6A	ツェナーダイオード	D30	
	Vi013500	LED	SLR-34DC3H4 (YEL)	LED	D4~9	
	VJ290000	LED	SLR-34VC3H4 (RED)	LED	D3,11	
	RA250000	CHIP RESISTOR	0Ω 1/8W	チップ抵抗	J1~10	
	CB069250	BINDING TIE	BK-1	束線止め		
	BB069510	GROUND PLATE		ランド金具		
	BB071360	TERMINAL,SCREW	8.3x13	ネジ端子		
	VA119100	HEAT SINK		ヒートシンク		
	CB088510	STOPPER		ストッパー		

*New Parts (新規部品)

ランク : Japan only

Ref. NO.	PART NO.	Description	部 品 名	Remarks	Markets	ランク
	VH273600	SUB CIRCUIT BOARD	サブシート		R	
	VH273700	SUB CIRCUIT BOARD	サブシート		AB	
	VH274000	SUB CIRCUIT BOARD	サブシート		G	
	Fi414100	CERAMIC CAP	0.01uF	スパークキラーコン	C407	△
	FG244220	CERAMIC CAP	0.022uF 50V	セラコン	C402,405	G
	FG244470	CERAMIC CAP	0.047uF 50V	セラコン	C408,409	G
	UA254100	MYLAR FILM CAP	0.01uF 50V	マイラーコン	C401,403,404,406	G
	GD900470	COIL	1.5uH	空芯コイル	L401,402	
	HL316180	METAL OXIDE RESISTOR	1.8KΩ 2W	酸化金属被膜抵抗	R403,404	
	HV454100	FLAME PROOF CARBON RESISTOR	10Ω 1/4W	不燃化カーボン抵抗	R401,402	
	VG442500	ZENER DIODE	MTZJ24B	ツェナーダイオード	D401,402	
	KC002000	RELAY	JR2A-DC24V	リレー	RY401,402	
	VC409700	PUSH SWITCH	ESB-82101V-F	プッシュSW	SW401	△
	KB000370	FUSE	3.5A 250V	ヒューズ	F402	△
	KB001300	FUSE	7.0A 250V	ヒューズ	F401	R △
	KB002980	FUSE	2.5A	ヒューズ	F401	ABG △
	VA961800	VOLTAGE SELECTOR		電圧切替器	R	△
	LB201060	FUSE HOLDER PIN	YSH403T	ヒューズホルダーピン	ABG	
	LB201970	FUSE HOLDER PIN		ヒューズホルダーピン	R	
	LB608170	AC OUTLET	M7032D	AC アウトレット	R	△
	VC720900	SPEAKER TERMINAL	8P	スピーカターミナル	G	
	VC313700	SPEAKER TERMINAL	8P	スピーカターミナル	RAB	

*New Parts (新規部品)

ランク : Japan only

AX-540

1 ■ EXPLODED VIEW

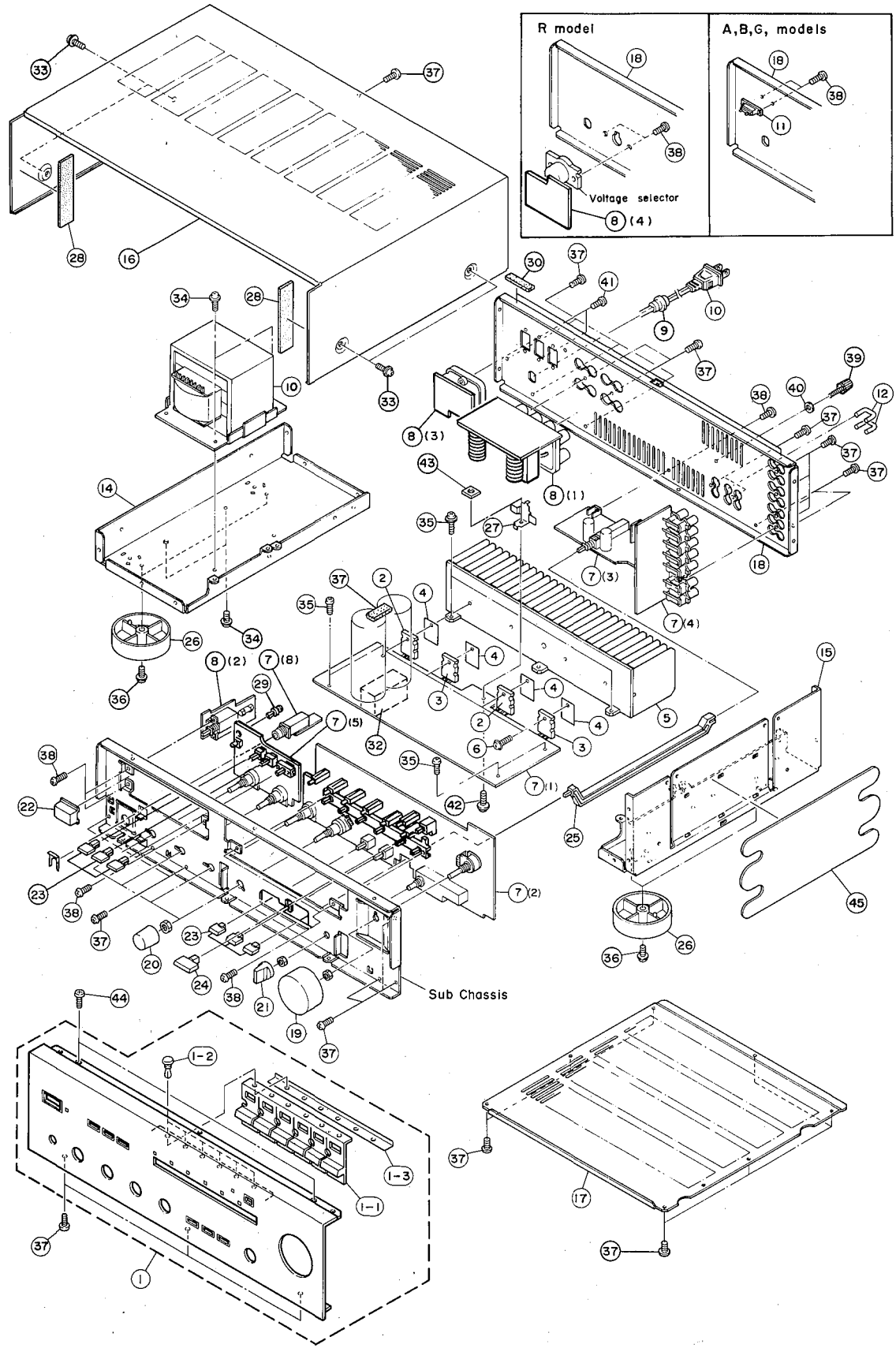

MECHANISM PARTS Note) ∅ : Diameter

Ref. NO.	PART NO.	Description	部 品 名		Remarks	Markets	ランク
1	VJ243100	PANEL UNIT			BL		
1	VJ243200	PANEL UNIT			T		
1-1	VJ234900	BUTTON			BL		
1-1	VJ235200	BUTTON			T		
1-2	CB068880	PLASTIC RIVET					
1-3	VJ556400	SPACER					
2	iX608110	TRANSISTOR	2SA1301 R,0		Q40,42		△
3	iX608120	TRANSISTOR	2SC3280 R,0		Q38,44		△
4	VC397200	SHEET	D-290				
5	BA095560	RADIATOR					
6	EK330020	BW HEAD TAPPING SCREW	3x14-10	ZMC2-BL			
7	VJ243300	MAIN CIRCUIT BOARD				RAB	
7	VJ243500	MAIN CIRCUIT BOARD				G	
8	VH273600	SUB CIRCUIT BOARD				R	
8	VH273700	SUB CIRCUIT BOARD				AB	
8	VH274000	SUB CIRCUIT BOARD				G	
9	CB620190	CORD STOPPER	CH-22B			RABG	
10	XG095A00	POWER TRANSFORMER				R	△
10	XG096A00	POWER TRANSFORMER				AB	△
10	XG097A00	POWER TRANSFORMER				G	△
11	VD614100	TERMINAL	2P	ST8VP-B		ABG	
12	LB101110	SHORT PLUG					
13	VE371000	POWER CORD	6A	250V 2m		R	△
13	MG002310	POWER CORD	7.5A	250V		A	△
13	MG002330	POWER CORD	6A	300V		B	△
13	MG002320	POWER CORD	2.5A	250V		G	△
14	AA631260	FRAME, SIDE L					
15	AA631270	FRAME, SIDE R					
16	VJ209000	TOP COVER			BL		
16	VJ209100	TOP COVER			T		
17	AA631320	BOTTOM COVER					
18	VJ210300	REAR PANEL				R	
18	VJ210400	REAR PANEL				AB	
18	VJ210500	REAR PANEL				G	
19	VH815400	KNOB	VR		BL		
19	VH815500	KNOB	VR		T		
20	VH889200	KNOB	TONE, BAL., LOUD.		BL		
20	VH889300	KNOB	TONE, BAL., LOUD.		T		
21	VJ211700	KNOB	REC OUT		BL		
21	VJ211800	KNOB	REC OUT		T		
22	VH841900	BUTTON	POWER		BL		
22	VH842000	BUTTON	POWER		T		
23	VH816000	BUTTON	SP., TONE BY.		BL		
23	VH816100	BUTTON	SP. TONE BY.		T		
24	VJ235000	BUTTON	CD DIR.		BL		
24	VJ235100	BUTTON	CD DIR.		T		
25	CB659320	ROD	S		BL		
26	CB660950	LEG			BL		
26	V1175700	LEG			T		
27	BB070960	PUSHER, TR					

*New Parts (新規部品)

ランク : Japan only

Ref. NO.	PART NO.	Description	部 品 名		Remarks	Markets	ランク
28	VF661800	PAD		パッド			
29	CB099600	PLASTIC RIVET		プラスチックリベット			
30	VJ212100	DAMPER	3.5/8/28	ダンパー			
31	VJ314500	CUSHION		クッション			
32	VH604700	CUSHION		クッション			
33	EX601080	CUP S-TITE SCREW	4x8	FCRM3-BL	カップSタイトネジ	BL	
33	EX601060	BW HEAD S-TITE SCREW	4x8-10	FCRM3-BL	BWヘッドSタイトネジ	T	
34	EX601080	CUP S-TITE SCREW	4x8	FCRM3-BL	カップSタイトネジ		
35	EX600700	BW HEAD TAPPING SCREW	3x8	FCM3	BWヘッドタッピングネジ		
36	EX600090	CUP B-TITE SCREW	3x8	FCRM3-BL	カップBタイトネジ		
37	EN340020	BIND HEAD BONDING TAP. SCREW	3x8	FCRM3-BL	ボンディングBタイトネジ		
38	ED330066	BIND HEAD SCREW	3x6	FCRM3-BL	バインド小ネジ	PACK	
39	AA627310	GROUND TERMINAL	3x13		GNDターミナル		
40	EV901360	PLAIN WASHER	3.6x10x0.8	FNM3-3G	平座金みがき丸		
41	E1330086	BIND HEAD TAPPING SCREW	3x8	FCRM3-BL	バインドBタイトネジ		R
42	ED030086	BIND HEAD S-TITE SCREW	3x8	ZMC2-Y	バインドSタイトネジ		
43	VF452300	PUSH NUT	SPN-2.6		軸用プッシュナット		
44	E1330066	BIND HEAD B-TITE SCREW	3x6	FCRM3-BL	バインドBタイトネジ	PACK	
45	VJ596900	SHEET/PROTECTOR			保護シート		
	CB069250	BINDING TIE	BK-1		束線止め		

*New Parts (新規部品)

ランク : Japan only

Parts List for Carbon Resistors

Value	1/4W Type Part No.	1/6W Type Part No.	Value	1/4W Type Part No.	1/6W Type Part No.
1.0 Ω	HJ35 3100	HF853100	12 KΩ	HJ35 7120	HF85 7120
1.8 Ω	HJ35 3180	*	15 KΩ	HJ35 7150	HF85 7150
2.2 Ω	HJ35 3220	HF853220	18 KΩ	HJ35 7180	HF85 7180
3.3 Ω	HJ35 3330	HF853330	22 KΩ	HJ35 7220	HF85 7220
4.7 Ω	HJ35 3470	HF853470	27 KΩ	HJ35 7270	HF85 7270
5.6 Ω	HJ35 3560	HF853560	33 KΩ	HJ35 7330	HF85 7330
10 Ω	HJ35 4100	HF854100	39 KΩ	HJ35 7390	HF85 7390
15 Ω	HJ35 4150	HF854150	47 KΩ	HJ35 7470	HF85 7470
22 Ω	HJ35 4220	HF854220	56 KΩ	HJ35 7560	HF85 7560
27 Ω	HJ35 4270	HF854270	68 KΩ	HJ35 7680	HF85 7680
33 Ω	HJ35 4330	HF854330	82 KΩ	HJ35 7820	HF85 7820
39 Ω	HJ35 4390	HF854390	91 KΩ	HJ35 7910	HF85 7910
47 Ω	HJ35 4470	HF854470	100 KΩ	HJ35 8100	HF85 8100
56 Ω	HJ35 4560	HF854560	120 KΩ	HJ35 8120	HF85 8120
68 Ω	HJ35 4680	HF854680	150 KΩ	HJ35 8150	HF85 8150
82 Ω	HJ35 4820	HF854820	180 KΩ	HJ35 8180	HF85 8180
100 Ω	HJ35 5100	HF855100	220 KΩ	HJ35 8220	HF85 8220
110 Ω	HJ35 5110	HF855110	270 KΩ	HJ35 8270	HF85 8270
120 Ω	HJ35 5120	HF855120	330 KΩ	HJ35 8330	HF85 8330
150 Ω	HJ35 5150	HF855150	390 KΩ	HJ35 8390	HF85 8390
160 Ω	HJ35 5160	*	470 KΩ	HJ35 8470	HF85 8470
180 Ω	HJ35 5180	HF855180	560 KΩ	HJ35 8560	HF85 8560
220 Ω	HJ35 5220	HF855220	680 KΩ	HJ35 8680	HF85 8680
270 Ω	HJ35 5270	HF855270	820 KΩ	HJ35 8820	HF85 8820
330 Ω	HJ35 5330	HF855330	1.0 MΩ	HJ35 9100	HF85 9100
390 Ω	HJ35 5390	HF855390	1.2 MΩ	HJ35 9120	*
470 Ω	HJ35 5470	HF855470	1.5 MΩ	HJ35 9150	HF85 9150
510 Ω	*	HF855510	1.8 MΩ	HJ35 9180	HF85 9180
560 Ω	HJ35 5560	HF855560	2.2 MΩ	HJ35 9220	HF85 9220
680 Ω	HJ35 5680	HF855680	3.3 MΩ	HJ35 9330	HF85 9330
820 Ω	HJ35 5820	HF855820	3.9 MΩ	HJ35 9390	*
910 Ω	HJ35 5910	HF855910	4.7 MΩ	HJ35 9470	HF85 9470
1.0 KΩ	HJ35 6100	HF85 6100			
1.2 KΩ	HJ35 6120	HF85 6120			
1.5 KΩ	HJ35 6150	HF85 6150			
1.8 KΩ	HJ35 6180	HF85 6180			
2.0 KΩ	HJ35 6200	HF85 6200			
2.2 KΩ	HJ35 6220	HF85 6220			
2.4 KΩ	HJ35 6240	HF85 6240			
2.7 KΩ	HJ35 6270	HF85 6270			
3.0 KΩ	HJ35 6300	HF85 6300			
3.3 KΩ	HJ35 6330	HF85 6330			
3.6 KΩ	HJ35 6360	HF85 6360			
3.9 KΩ	HJ35 6390	HF85 6390			
4.7 KΩ	HJ35 6470	HF85 6470			
5.1 KΩ	HJ35 6510	HF85 6510			
5.6 KΩ	HJ35 6560	HF85 6560			
6.8 KΩ	HJ35 6680	HF85 6680			
8.2 KΩ	HJ35 6820	HF85 6820			
9.1 KΩ	HJ35 6910	HF85 6910			
10 KΩ	HJ35 7100	HF85 7100			

1/4W Type

HJ35 ○○○○

← 10mm →

1/6W Type

HF85 ○○○○

← 5mm →

AX-540

YAMAHA

AX-540
