

# Digital Video Camcorder

Mini DV Digital  
Video  
Cassette

**VP-D80/D81**  
**VP-D80i/D81i**

- AF** Auto Focus  
**CCD** Charge Coupled Device  
**LCD** Liquid Crystal Display

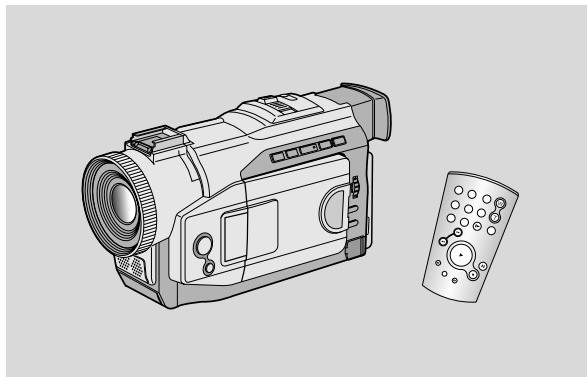

## Owner's Instruction Book

Before operating the unit, please read this instruction book thoroughly, and retain it for future reference.

**SAMSUNG**  
ELECTRONICS



This product meets the intent of  
Directive 89/336 CEE, 73/23 CEE, 93/68 CEE.

**Contents**

<b>Notes and Safety Instructions</b> .....	<b>6</b>
<b>Getting to Know Your Camcorder</b> .....	<b>11</b>
Features .....	11
Accessories Supplied with camcorder .....	12
Basic Accessories .....	12
Front & Left View .....	13
Left Side View .....	14
Right & Top View .....	15
Rear & Bottom View .....	16
Remote control .....	17
OSD (On Screen Display in CAMERA and PLAYER modes) .....	18
Turning the OSD on/off (On Screen Display) .....	19
<b>Preparation</b> .....	<b>20</b>
How to use the Remote Control .....	20
Battery Installation for the Remote Control .....	20
Self Record using the Remote Control .....	20
Lithium Battery Installation .....	21
Adjusting the Hand Strap .....	22
Hand strap .....	22
Shoulder strap.....	22
Attaching the Ring Hood .....	22
Connecting a Power Source .....	23
To use the AC Power adapter and the DC Cable .....	23
Using the Lithium Ion Battery Pack .....	24
Charging the Lithium Ion Battery Pack .....	24
Table of continuous recording time based on model and battery type .....	25
Battery level display .....	26
Inserting and Ejecting a Cassette .....	27
<b>BASIC Recording</b> .....	<b>28</b>
Making your First Recording .....	28
Record Search .....	29
Hints for Stable Image Recording .....	30
Recording with the LCD monitor .....	30
Recording with the Viewfinder .....	30

# Contents

Adjusting the LCD .....	31
Using the VIEWFINDER .....	32
Adjusting the Focus .....	32
Playing back a tape you have recorded on the LCD .....	33
Adjusting the LCD during PLAY .....	34
Controlling Sound from the Speaker .....	34
<b>Advanced Recording .....</b>	<b>35</b>
Use of various Functions .....	35
Setting menu items .....	35
Set the camcorder to CAMERA or PLAYER mode .....	35
Availability of functions in each mode .....	36
CLOCK SET .....	37
REMOCON .....	38
BEEP SOUND .....	39
DEMONSTRATION .....	40
PROGRAM AE .....	41
Setting the PROGRAM AE .....	42
WHT. BALANCE (WHITE BALANCE) .....	43
Zooming In and Out with DIGITAL ZOOM .....	44
Zooming In and Out .....	44
Digital Zoom .....	45
EIS (Electronic Image Stabilizer) .....	46
DSE (Digital Special Effects) SELECT .....	47
Selecting an effect .....	48
CUSTOM.Q .....	49
REC MODE .....	50
AUDIO MODE .....	51
WIND CUT .....	52
DATE/TIME .....	53
TV DISPLAY .....	54
Using Quick Menu .....	55
Setting the Quick menu .....	56
SHUTTER SPEED & EXPOSURE .....	57
EASY Mode (for Beginners) .....	58
CUSTOM Mode .....	59

**Contents**

MF/AF (Manual Focus/Auto Focus) .....	60
Auto Focusing .....	60
Manual Focusing .....	60
BLC (Back Light Compensation) .....	61
Fade In and Out .....	62
To Start Recording .....	62
To Stop Recording (use FADE IN / FADE OUT) .....	62
Audio dubbing .....	63
Dubbing sound .....	63
Dubbed Audio Playback .....	64
PHOTO Image Recording .....	65
Searching for a PHOTO picture .....	65
NIGHT CAPTURE (0 lux recording) .....	66
Various Recording Techniques .....	67
<b>Playback .....</b>	<b>68</b>
Tape Playback .....	68
Playback on the LCD .....	68
Playback on a TV monitor .....	68
Connecting to a TV which has Audio Video input jacks .....	68
Connecting to a TV which has no Audio and Video input jacks .....	69
Playback .....	69
Various Functions while in PLAYER mode .....	70
Playback pause .....	70
Picture search (Forward/Reverse) .....	70
Slow playback (Forward/Reverse) .....	70
Frame advance (To play back frame by frame) .....	71
X2 Playback (Forward/Reverse ) .....	71
ZERO MEMORY .....	72
<b>Recording in PLAYER mode (VP-D80i/D81i only) .....</b>	<b>73</b>
<b>IEEE 1394 Data Transfer .....</b>	<b>74</b>
Transferring IEEE1394 (i.LINK)-DV standard data connections .....	74
Connecting to a DV device .....	74
Connecting to a PC .....	74
System requirements .....	75
Recording with a DV connection cable (VP-D80i/D81i only) .....	75

# Contents

<b>USB interface (VP-D81/D81i only)</b> .....	<b>76</b>
Transferring a Digital Image through a USB Connection .....	76
System Requirements .....	76
Installing DVC Media Program .....	77
Connecting to a PC .....	79
<b>Maintenance</b> .....	<b>80</b>
After finishing a recording .....	80
Cleaning and Maintaining the Camcorder .....	81
Cleaning the VIEWFINDER .....	81
Cleaning the Video Heads .....	81
Using Your Camcorder Abroad .....	82
Power sources .....	82
Colour system .....	82
<b>Troubleshooting</b> .....	<b>83</b>
Troubleshooting .....	83
Self Diagnosis Display .....	83
Moisture Condensation .....	83
<b>Specifications</b> .....	<b>85</b>
<b>INDEX</b> .....	<b>86</b>
<b>Power Sources (United Kingdom Only)</b> .....	<b>87</b>

## Notes and Safety Instructions

### *Notes regarding the rotation of the LCD screen*

Please rotate the LCD screen carefully as illustrated.

Over rotation may cause damage to the inside of the hinge that connects the LCD screen to the Camcorder.

1. LCD screen closed.
2. Standard recording using the LCD screen.
3. Recording when looking at the LCD screen from the top.
4. Recording when looking at the LCD screen from the front.
5. Recording with the LCD screen closed.

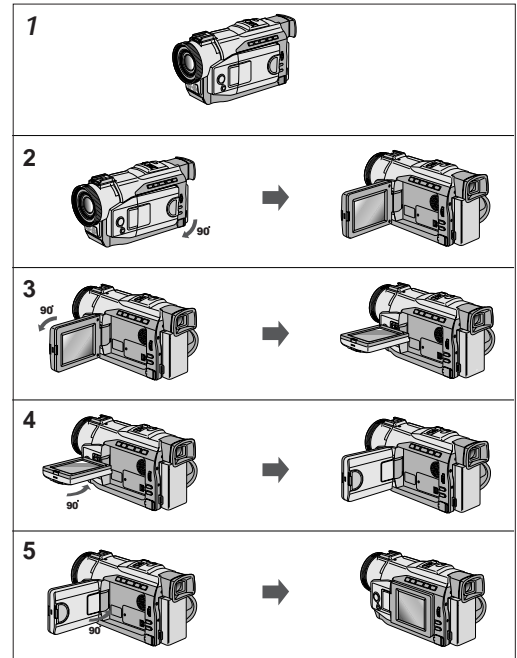

## Notes and Safety Instructions

---

### *Notices regarding COPYRIGHT*

Television programs, video tapes, DVD titles, films, and other program materials may be copyrighted. Unauthorized copying of copyrighted material may be against the law.

### *Notes regarding moisture condensation*

1. A sudden rise in atmospheric temperature may cause condensation to form inside the camcorder.

#### *for example:*

- When you move the camcorder from a cold location to a warm location (e.g. from outside to inside during winter.)
  - When you move the camcorder from a cool location to a hot location (e.g. from inside to outside during the summer.)
2. If the  (DEW) protection feature is activated, leave the camcorder for at least two hours in a dry, warm room with the cassette compartment opened and the battery removed.

### *Notes regarding CAMCORDER*

1. Do not leave the camcorder exposed to high temperature (above 60°C or 140°F).  
For example, in a parked car in the sun or exposed to direct sunlight.
2. Do not let the camcorder get wet.  
Keep the camcorder away from rain, sea water, and any other form of moisture. If the camcorder gets wet, it may get damaged.  
Sometimes a malfunction due to exposure to liquids cannot be repaired.

## Notes and Safety Instructions

### *Notes regarding the battery pack*

- Make sure that the battery pack is fully charged before starting to record.
- To preserve battery power, keep your camcorder turned off when you are not operating it.
- If your camcorder is in CAMERA mode, and it is left in STBY mode without being operated for more than 5 minutes with a tape installed, it will automatically turn itself off to protect against unnecessary battery discharge.
- Make sure that the battery pack is fitted firmly into place.  
Dropping the battery pack may damage it.
- A brand new battery pack is not charged.  
Before using the battery pack, you need to charge it completely.
- It is a good idea to use the viewfinder rather than the LCD when making long recording, because the LCD uses up more battery power.

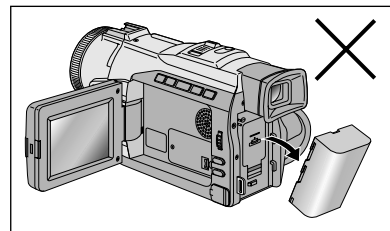

\* When the battery reaches the end of its life, please contact your local dealer.  
The batteries have to be dealt with as chemical waste.

### *Notes regarding the Video Head Cleaning*

- To ensure normal recording and a clear picture, clean the video heads regularly. If a square block-shape distorts playback, or only a blue screen is displayed, the video heads may be dirty. If this happens, clean the video heads with a dry type cleaning cassette.
- Do not use a wet-type cleaning cassette. It may damage the video heads.



## Notes and Safety Instructions

### *Note regarding the LENS*

- Do not film with the camera lens pointing directly at the sun.  
Direct sunlight can damage the CCD (Charge Coupled Device).

### *Notes regarding electronic viewfinder*

1. Do not position the camcorder such that the viewfinder is pointing towards the sun.  
Direct sunlight can damage the inside of the viewfinder. Be careful when placing the camcorder under sunlight or near a window exposed to sunlight.
2. Do not pick up the camcorder from the viewfinder.
3. Over-rotating of the viewfinder may damage it.

### *Notes regarding 'Record' or 'Playback' using the LCD*

1. The LCD display has been manufactured using high precision technology. However, there may be tiny dots (red, blue or green in color) that appear on the LCD display.  
These dots are normal and do not affect the recorded picture in any way.
2. When you use the LCD display under direct sunlight or outdoors, it may be difficult to see the picture clearly.  
If this occurs, we recommend using the viewfinder.
3. Direct sunlight can damage the LCD monitor.

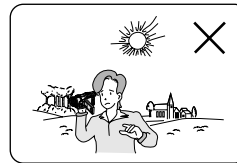

### *Notes regarding the hand strap*

- To ensure a steady picture during filming, check that the hand strap is properly adjusted.
- Do not force your hand into the hand strap as you could damage it.

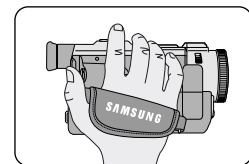

## Notes and Safety Instructions

---

### *Precautions regarding the Lithium battery*

1. The lithium battery maintains the clock function and user settings; even if the battery pack or AC adapter is removed.
2. The lithium battery for the camcorder lasts about 6 months under normal operation from time of installation.
3. When the lithium battery becomes weak or dead, the date/time indicator will flash for about five seconds when you set the power switch to CAMERA.  
In this case, replace the lithium battery with a new one(type CR2025 ).
4. Danger of explosion if battery is incorrectly replaced.  
Replace only with the same or equivalent type.

**Warning: Keep the LITHIUM BATTERY out of reach of children. Should a battery be swallowed, consult a doctor immediately.**

## Getting to Know Your Camcorder

---

### Features

- **Digital data transfer function with IEEE1394**  
By incorporating the IEEE 1394 (i.LINK™ : i.LINK is a serial data transfer protocol and interconnectivity system, used to transmit DV data) high speed data transport port, both moving and still images can be transferred to a PC, making it possible to produce or edit various images. (VP-DXX is not able to record and receive digital data from another DV Device.)
- **USB interface for digital image data transfer (VP-D81/D81i only)**  
You can transfer still images to a PC using the USB interface without an add-on card.
- **PHOTO**  
The PHOTO function lets you capture an object as a still along with sound, while in Camera mode.
- **400x Digital zoom**  
Allows you to magnify an image up to 400 times its original size.
- **Colour TFT LCD**  
A high-resolution colour TFT LCD gives you clean, sharp images as well as the ability to review your recordings immediately.
- **Electronic Image Stabilizer (EIS)**  
The EIS compensates for any handshake, reducing unstable images particularly at high magnification.
- **Various digital effects**  
The DSE (Digital Special Effects) allows you to give your films a special look by adding various special effects.
- **Back Light Compensation (BLC)**  
The BLC function compensates for the bright background behind a subject you're recording.
- **Program AE**  
The Program AE enables you to alter the shutter speed and aperture to suit the type of scene/action to be filmed.
- **NIGHT CAPTURE**  
The NIGHT CAPTURE function enables you to record a subject in a dark place.

# Getting to Know Your Camcorder

## Accessories Supplied with camcorder











Make sure that the following basic accessories are supplied with your digital video camera.

### Basic Accessories

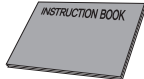
1. Lithium Ion Battery pack
2. AC Power Adapter
3. AC Cord
4. AUDIO/VIDEO cable
5. Instruction Book
6. Lithium batteries for Remote Control and Clock.  
(TYPE: CR2025, 2 EA)
7. S-VIDEO cable
8. Remote Control
9. Shoulder strap
10. USB cable (VP-D81/D81i only)
11. Software CD (VP-D81/D81i only)
12. Audio cable (VP-D81/D81i only)

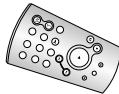
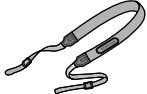
### Optional Accessory

13. Scart adapter

1. Lithium Ion Battery pack 	2. AC Power Adapter 	3. AC cord 
4. AUDIO/VIDEO cable 	5. Instruction Book 	6. Lithium batteries (2EA) 
7. S-VIDEO cable 	8. Remote Control 	9. Shoulder strap 
10. USB cable (VP-D81/D81i only) 	11. Software CD (VP-D81/D81i only) 	12. Audio cable (VP-D81/D81i only) 

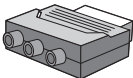
13. Scart adapter 
--

## Getting to Know Your Camcorder

### Front & Left View

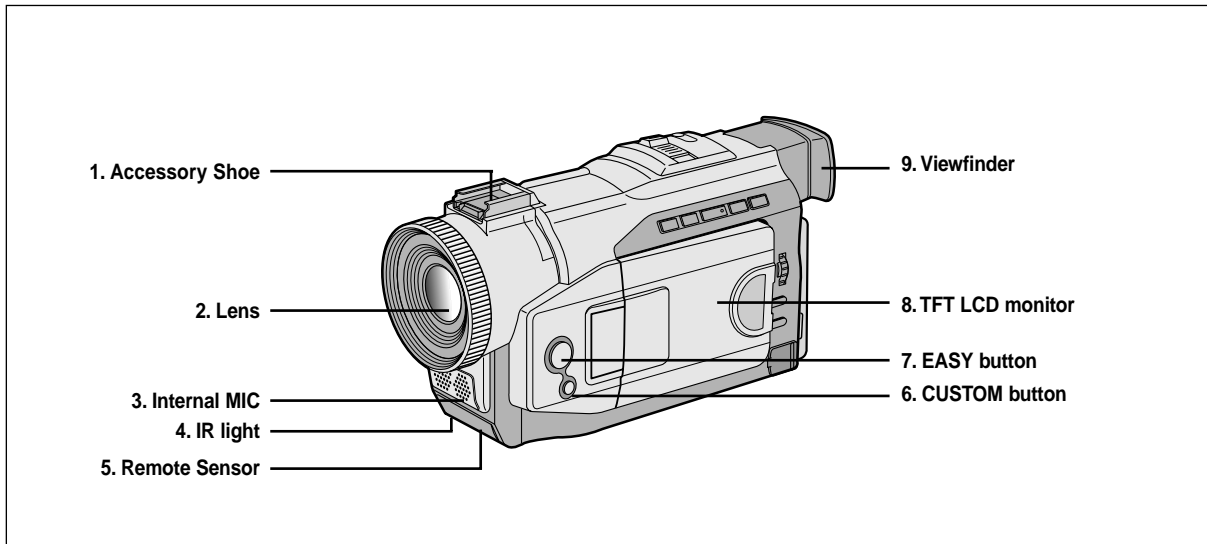

1. Accessory Shoe
2. Lens
3. Internal MIC
4. IR (Infra Red) light
5. Remote sensor

6. CUSTOM button (see page 59)
7. EASY button (see page 58)
8. TFT LCD monitor
9. Viewfinder (see page 32)

# Getting to Know Your Camcorder

## Left Side View

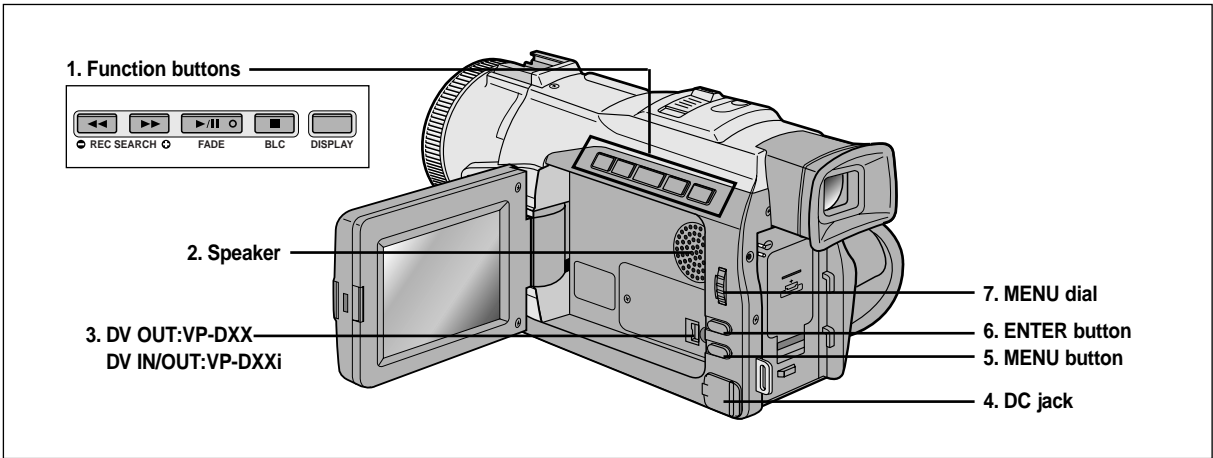

### 1. Function buttons

PLAYER	CAMERA
◀◀ : (REW)	REC SEARCH -
▶▶ : (FF)	REC SEARCH +
▶    : (PLAY/STILL)	FADE
■ : (STOP)	BLC
DISPLAY	DISPLAY

### 2. Speaker

### 3. DV OUT: VP-DXX DV IN/OUT:VP-DXXi

### 4. DC jack

### 5. MENU button

### 6. ENTER button

### 7. MENU dial

## Getting to Know Your Camcorder

### Right & Top View

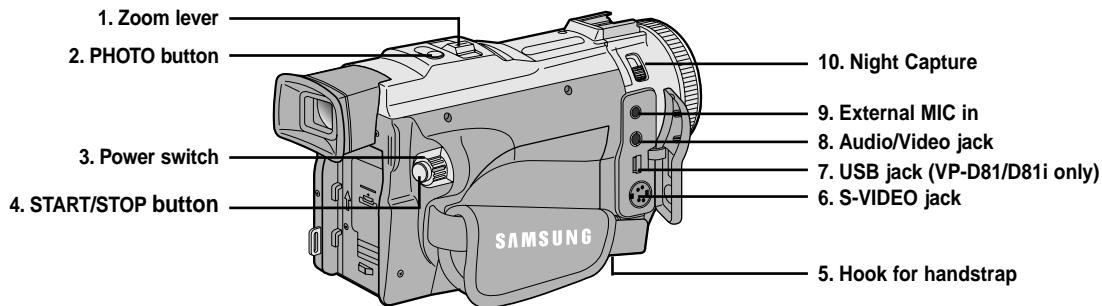

1. Zoom lever
2. PHOTO button (see page 65)
3. Power switch (CAMERA or PLAYER) (see page 21)
4. START/STOP button
5. Hook for handstrap
6. S-VIDEO jack
7. USB jack (VP-D81/D81i only)
8. Audio/Video jack
9. External MIC in
10. Night Capture

# Getting to Know Your Camcorder

## Rear & Bottom View

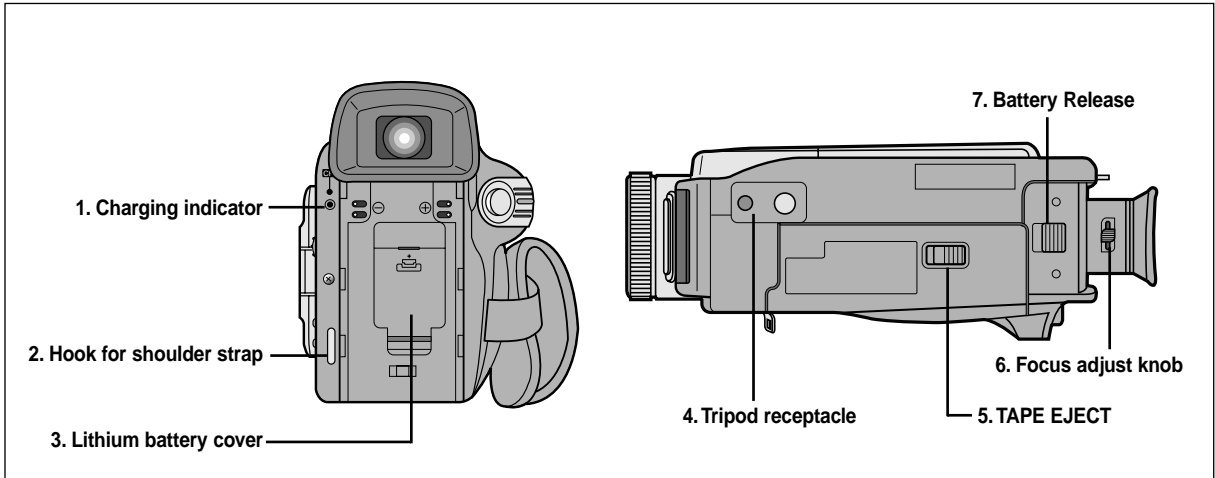

- 1. Charging indicator
- 2. Hook for shoulder strap
- 3. Lithium battery cover
- 4. Tripod receptacle
- 5. TAPE EJECT
- 6. Focus adjust knob
- 7. Battery Release



# Getting to Know Your Camcorder

## Remote control

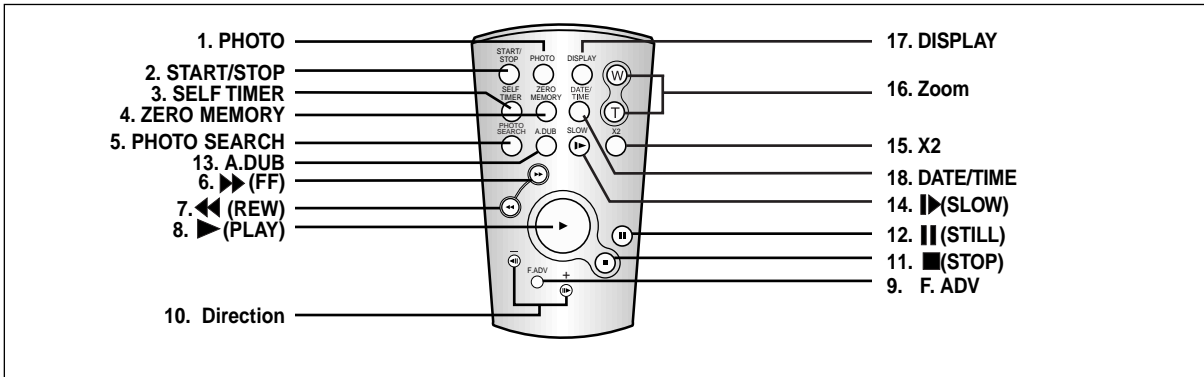

- 1. PHOTO
- 2. START/STOP
- 3. SELF TIMER (see page 20)
- 4. ZERO MEMORY (see page 72)
- 5. PHOTO Search
- 6. ►► (FF)
- 7. ◀◀ (REW)
- 8. ► (PLAY)
- 9. F. ADV (see page 71)

- 10. Direction (◀||, ||►)
- 11. ■ (STOP)
- 12. || (STILL)
- 13. A.DUB (see page 63)
- 14. ►► (SLOW)
- 15. X2 (see page 71)
- 16. Zoom
- 17. Display
- 18. DATE/TIME

# Getting to Know Your Camcorder

## *OSD (On Screen Display in CAMERA and PLAYER modes)*

1. Battery level (see page 26)
2. Custom or Easy mode (see pages 58, 59)
3. DSE (Digital Special Effects) mode (see page 47)
4. Program AE (see page 41)
5. White Balance mode (see page 43)
6. BLC (Back Light Compensation) (see page 61)
7. Manual focus (see page 60)
8. Shutter speed and EXPOSURE (see page 57)
9. Zoom position (see page 44)
10. NIGHT CAPTURE (see page 66)
11. DATE/TIME (see page 53)
12. USB (VP-D81/D81i only)
13. REMOCON
14. WIND CUT (see page 52)
15. Audio recording mode (see page 51)
16. Zero memory indicator (see page 72)
17. Remaining Tape (measured in minutes)
18. Tape counter
19. Operating mode
20. Record speed mode
21. PHOTO mode
22. Self recording and waiting timer (see page 20)
23. EIS (see page 46)

### *OSD in CAMERA mode*

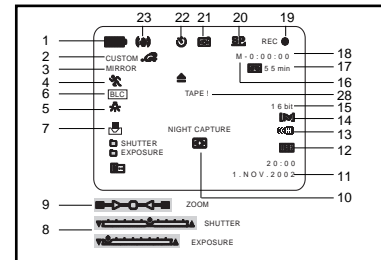

## Getting to Know Your Camcorder

- 24. Volume control (see page 34)
- 25. Audio playback channel
- 26. DV IN (VP-DXXi only)  
(DV data transfer mode) (see page 75)
- 27. DEW (See page 7)
- 28. Message Line

### Turning the OSD on/off (On Screen Display)

#### • Turning OSD on/off

Press the DISPLAY button on the left side panel.

- Each press of the button toggles the OSD function on and off.
- When you turn the OSD off,

**In CAMERA mode:** The STBY, REC, EASY.Q and CUSTOM.Q modes are always displayed on the OSD, even when the OSD is turned OFF and the key input is displayed for 3 seconds then turned off.

**In PLAYER mode:** When you press any Function button, the function is displayed on the OSD for 3 seconds before it turns off.

#### • Turning the DATE/TIME on/off

- The DATE/TIME is not affected when the OSD function is switched ON or OFF.
- To turn the DATE/TIME on or off, access the menu and change the DATE/TIME mode. (see page 53)
- You may also use the Quick Menu to turn the DATE/TIME ON or OFF. (see page 55) (only in CAMERA mode)

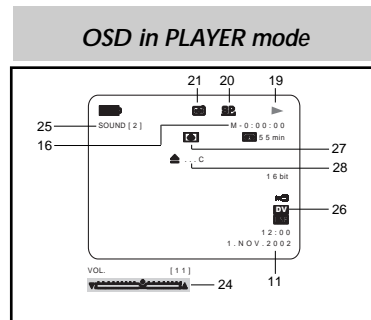

## Preparation

### *How to use the Remote Control*

#### **Battery Installation for the Remote Control**

- ⌘ You need to insert or replace the lithium battery when :
  - You purchase the camcorder.
  - The remote control doesn't work.
- ⌘ Ensure that you insert the lithium cell correctly, following the + and - markings.
- ⌘ Be careful not to reverse the polarity of the battery.

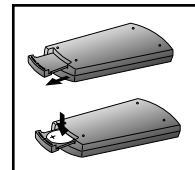

#### **Self Record using the Remote Control**

When you use the Self Timer function on the remote control, the recording begins automatically in 10 seconds.

1. Set the camcorder to CAMERA mode.
2. Press the SELF TIMER button until the appropriate indicator is displayed in the viewfinder.
3. Press the START/STOP button to start the timer.
  - After a 10 second wait, recording starts.
  - Press START/STOP again when you wish to stop recording.

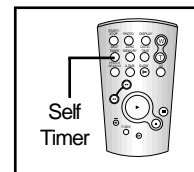

## Preparation

### *Lithium Battery Installation*

- ⌘ The lithium battery maintains the clock function and preset contents of the memory; even if the battery pack or AC power adapter is removed.
- ⌘ The lithium battery for the camcorder lasts about 6 months under normal operation from the time of installation.
- ⌘ When the lithium battery becomes weak or dead, the date/time indicator flashes for about 5 seconds when you set the power switch to CAMERA.

In this case, replace the lithium battery with CR2025 type.

1. Open the Lithium battery cover from the camera.
2. Position the Lithium cell in the holder, with the positive (⊕) terminal face outward.
3. Close the lithium battery cover.

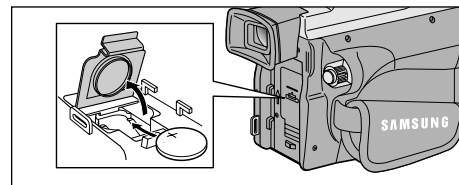

#### Reference

The lithium battery must be inserted in the correct direction.

**Warning: Keep the LITHIUM BATTERY out of the reach of the children.  
Should any battery be swallowed, consult a doctor immediately.**

## Preparation

### *Adjusting the Hand Strap*

It is very important to ensure that the Hand strap has been correctly adjusted before you begin your recording.

The hand strap enables you to :

- Hold the camcorder in a stable, comfortable position.
- Press the Zoom and START/STOP button without having to change the position of your hand.

### **Hand strap**

- a. Pull open the Hand Strap cover and release the Hand Strap.
- b. Adjust its length and stick it back onto the Hand Strap cover.
- c. Close the Hand Strap cover again.

### **Shoulder Strap**

The Shoulder Strap enables you to carry your camcorder around in complete safety.

1. Insert the end of strap into the Shoulder Strap hook on the camcorder.  
Insert the other end of strap into ring inside hand strap.
2. Thread each end into the buckle, adjust the length of the strap and then pull it tight in the buckle.

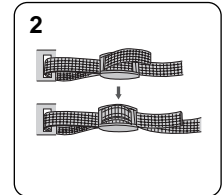
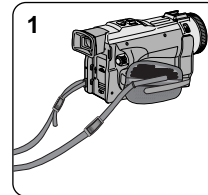
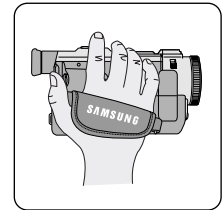
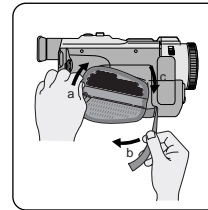

## Preparation

### Connecting a Power Source

There are two types of power source that can be connected to your camcorder.

- The AC Power Adapter and AC cord : used for indoor recording.
- The Battery Pack : used for outdoor recording.

### To use the AC Power adapter and DC Cable

1. Connect the AC Power adapter to the AC cord.
2. Connect the AC cord to a wall socket.

#### Reference

The plug and wall socket type may differ according to your resident country.

3. Connect the DC cable to the DC jack socket of the camcorder.
4. Set the camcorder to each mode by holding down the tab on the power switch and turning it to the CAMERA or PLAYER mode.

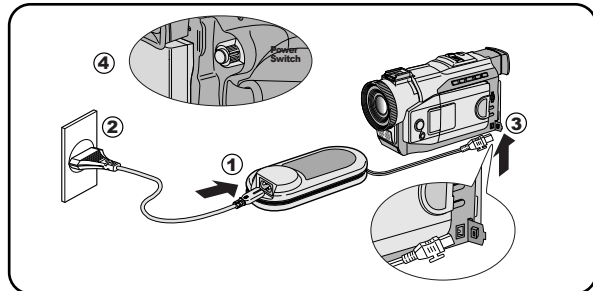

## Preparation

### Using the Lithium Ion Battery Pack

- ※ The amount of continuous recording time available depends on :
  - The type and capacity of the battery pack you are using.
  - How often the Zoom function is used.
 It is recommended that you have several batteries available.

### Charging the Lithium Ion Battery Pack

1. Attach the battery pack to the camcorder.
2. Connect the AC Power adapter to an AC cord and connect the AC cord to a wall socket.
3. Connect the DC cable to the DC jack socket on the camcorder.
4. Turn the Camera power switch to off, and the charging indicator will start to flash, showing that the battery is charging.

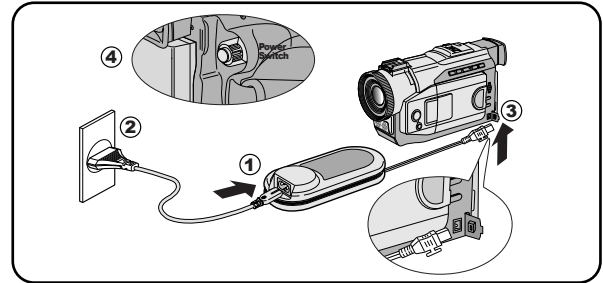

Blinking time	Charging rate
Once per second	Less than 50%
Twice per second	50% ~ 75%
Three times per second	75% ~ 90%
Blinking stops and stays on	90 ~ 100%
On for a second and off for a second	Error - Reset the battery pack and the DC cable

5. When the battery is fully charged, disconnect the battery pack and the AC Power adapter from the camcorder.
  - Even with the power switched off, the battery pack will still discharge if it is left connected to the camcorder.

### Reference

- The battery pack may be charged a little at the time of purchase.
- To prevent reduction in the life and capacity of the battery pack, always remove it from the camcorder after it is fully charged.



## Preparation

### Using the Lithium Ion Battery Pack

#### Table of continuous recording time based on model and battery type.

- ⌘ If you close the LCD screen, it switches off and the EVF switches on automatically.
- ⌘ The continuous recording times given in the table above are approximations.  
Actual recording time depends on usage.

Battery \ Time	Charging time	Continuous recording time	
		LCD ON	EVF ON
SB-L110	Approx. 2hr	Approx. 1hr 30min	Approx. 2hr
SB-L220	Approx. 3hr 30min	Approx. 3hr 10min	Approx. 4hr 10min

#### Reference

- The battery pack should be recharged in an environment of between 32°F (0°C) and 104°F (40°C).
- The battery pack should never be charged in a room temperature that is below 32°F (0°C).
- The life and capacity of the battery pack will be reduced if it is used in temperatures below 32°F (0°C) or left in temperatures above 104°F (40°C) for a long period, even when it is fully recharged.
- Do not put the battery pack near any heat source (fire or flames, for example).
- Do not disassemble, process, pressure, or heat the Battery Pack.
- Do not allow the + and - terminals of the battery pack to be short-circuited.  
It may cause leakage, heat generation, induce fire and overheating.

## Preparation

### Battery level display

- The battery level display indicates the amount of power remaining in the battery pack.
  - Fully charged
  - 20~40% used
  - 40~80% used
  - 80~95% used
  - Completely used (flickers)  
(The camcorder will turn off soon, change the battery as soon as possible)
- ⚠ Please refer to the table on page 25 for approximate continuous recording times.
- ⚠ The recording time is affected by environmental temperature and conditions.

The recording time becomes very short in a cold environment. The continuous recording times in the operating instructions are measured using a fully charged battery pack at 77°F(25°C). As the environmental temperature and conditions may differ when you actually use the camcorder, the remaining battery time may not be the same as the approximate continuous recording times given in these instructions.

### Tips for Battery Identification

A charge mark is provided on the battery pack to help you remember whether it has been charged or not.

Two colours are provided (red and black)-you may choose which one indicates charged and which indicates discharged.

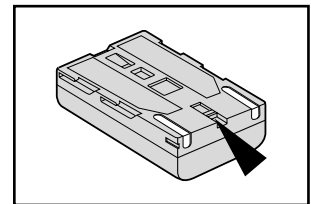
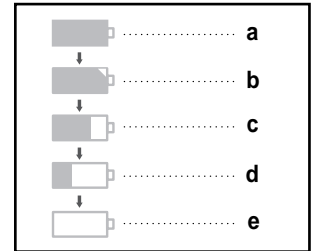

## Preparation

### Inserting and Ejecting a Cassette

- ⚠ When inserting a tape or closing a cassette holder, do not apply excessive force. This may cause a malfunction.
  - ⚠ Do not use any tapes other than Mini DV CASSETTES.
1. Connect a power source and slide the TAPE EJECT switch and open the cassette door.
    - The cassette holding mechanism rises automatically.
  2. Insert a tape into the cassette holder with the tape window facing outward and the protection tab toward the top.
  3. Press the area labelled PUSH on the cassette holding mechanism until it clicks into place.
    - The cassette is loaded automatically.
  4. Close the cassette door.
    - Close the door completely until you can hear a “click”.

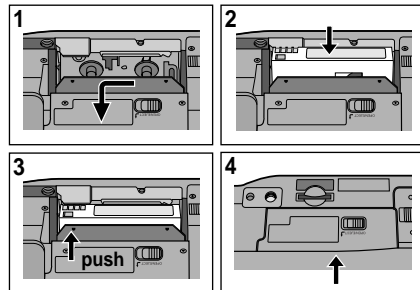

### Reference

When you have recorded something that you wish to keep, you can protect it so that it will not be accidentally erased.

#### a. Protecting a tape :

Push the safety tab on the cassette so that the hole is uncovered.

#### b. Removing the tape protection :

If you no longer wish to keep the recording on the cassette, push the write-protect tab back so that it covers the hole.

#### • How to keep a tape

- a. Avoid places with magnets or magnetic interference.
- b. Avoid humidity and dust prone places.
- c. Keep the tape in an upright position and avoid storing it in direct sunlight.
- d. Avoid dropping or knocking your tapes.

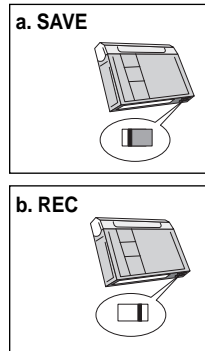

## Basic Recording

### *Making your First Recording*

1. Connect a Power source to the camcorder. (see page 23)  
(A battery pack or a AC power adapter)
  - Insert a cassette. (see page 27)
2. Remove the LENS CAP and hook it onto the hand strap.
3. Set the power switch to the CAMERA position.
  - Open the LCD monitor and make sure that STBY is displayed.
  - If the protection tab of the cassette is open, STOP and PROTECTION! will be displayed.
  - Make sure the image you want to record appears in the LCD monitor or viewfinder.
  - Make sure the battery level indicates that there is enough remaining power for your expected recording time.
4. To start recording, press the START/STOP button.
  - REC is displayed in the LCD.
  - To stop recording, press the START/STOP button again.
  - STBY is displayed in the LCD.

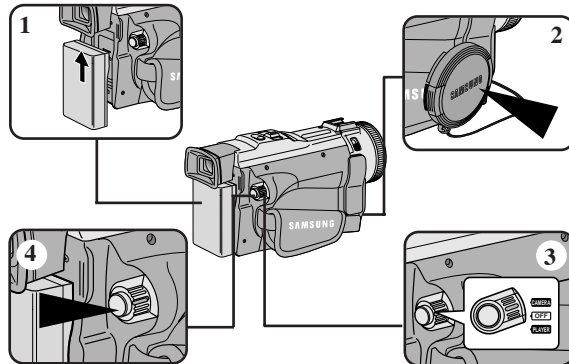

## Basic Recording

When a cassette is loaded and the camcorder is left in the STBY mode for more than 5 minutes without being used, it will switch off automatically.

To use it again, push the START/STOP button or set the Power switch to OFF and then back to CAMERA.

This Auto Power off feature is designed to save battery power.

### Record Search (REC SEARCH)

- ⌘ You can view a recording using the REC SEARCH +, - function in STBY mode. REC SEARCH - enables you to play the recording backwards and REC SEARCH + enables you to play it forwards, for as long as you keep each button pressed down.
- ⌘ If you press the REC SEARCH - button in STBY mode, your camcorder will play in reverse for 3 seconds and return to the original position automatically.

#### Reference

Mosaic shaped distortion may appear on the screen while in Record Search mode.

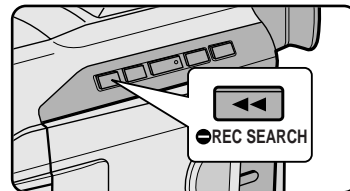
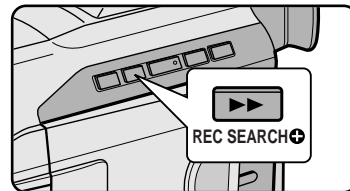

## Basic Recording

### *Hints for Stable Image Recording*

- While recording, it is very important to hold the camcorder correctly.
- Fix the LENS cap firmly by clipping it to the hand strap. (refer to the figure)

### **Recording with the LCD monitor**

1. Hold the camcorder firmly using the hand strap.
2. Place your right elbow against your side.
3. Place your left hand under or beside the LCD to support and adjust it.  
Do not touch the built-in microphone.
4. Choose a comfortable, stable position for the shots that you are taking.  
You can lean against a wall or on a table for greater stability.  
Do not forget to breathe gently.
5. Use the LCD frame as a guide to determine the horizontal plane.
6. Whenever possible, use a tripod.

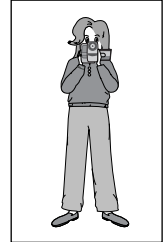

### **Recording with the Viewfinder**

1. Hold the camcorder firmly using the hand strap.
2. Place your right elbow against your side.
3. Place your left hand under the camcorder to support it.  
Be sure not to touch the built-in microphone.
4. Choose a comfortable, stable position for the shots that you are taking.  
You can lean against a wall or on a table for greater stability.  
Do not forget to breathe gently.
5. To view an object through the viewfinder, pull it out until you hear the 'click' sound.  
Excessive force may cause damage to the viewfinder.
6. Place your eye firmly against the viewfinder eyecup.
7. Use the viewfinder frame as a guide to determine the horizontal plane.
8. Whenever possible, use a tripod.

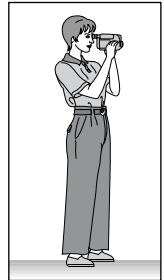

# Basic Recording

## Adjusting the LCD

- ⌘ Your camcorder is equipped with a 2.5 inch colour Liquid Crystal Display(LCD) screen, which enables you to view what you are recording or playing back directly.
- ⌘ Depending on the conditions under which you are using the camcorder (indoors or outdoors for example), you can adjust ;
  - BRIGHT SELECT
  - BRIGHT ADJUST
  - COLOUR ADJUST

1. Set the POWER switch to CAMERA position.
  - In the PLAYER mode, you may only setup the LCD while the tape is playing.
2. Open the LCD screen, and the LCD switches on.
3. Press the MENU button.
4. Turn the MENU DIAL so that VIEWER is highlighted and then press the ENTER button.
5. Turn the MENU DIAL so that LCD ADJUST is highlighted.
6. Press the ENTER button to enter the sub-menu.
7. Turn the MENU DIAL so that it highlights the menu item you want to adjust (BRIGHT SELECT, BRIGHT ADJUST, COLOUR ADJUST).

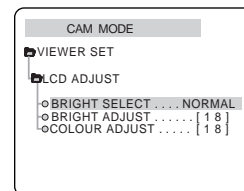
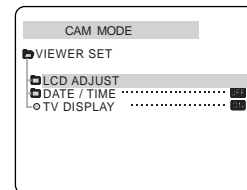
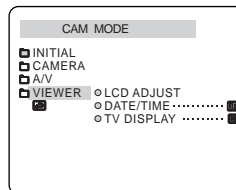
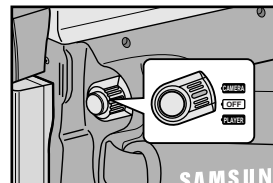

## Basic Recording

---

8. Press the ENTER button again.
  - You may select NORMAL or SUPER in the BRIGHT SELECT feature and press the ENTER button to save the setting.
  - Use the MENU DIAL to adjust the value of BRIGHT ADJUST and COLOUR ADJUST.
  - You can set values for BRIGHT ADJUST between 00 ~ 35 and COLOUR ADJUST between 00 ~ 35.
9. Press the MENU button to finish the setting.

### *Using the VIEWFINDER*

- ⚠ The VIEWFINDER will not work when the LCD is open.

#### **Adjusting the Focus**

Use the focus adjustment knob of the VIEWFINDER to focus the picture.  
(refer to figure )

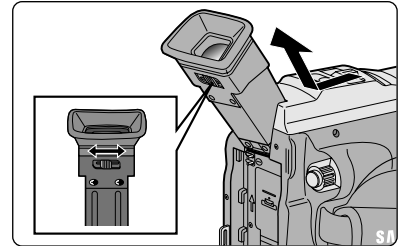



## Basic Recording

### *Playing back a tape you have recorded on the LCD*

- ⌘ You can monitor the playback picture on the LCD monitor.
- ⌘ Make sure that the battery pack is in place.

1. Hold down the power switch tab and turn it to the PLAYER position.
2. Insert the tape you wish to view. (see page 27)
3. Open the LCD screen.  
Adjust the angle of the LCD screen and set the brightness or colour if necessary.
4. Press the ◀◀ (REW) button to rewind the tape to the starting point.
  - To stop rewinding, press the ■ (STOP) button.
  - The camcorder stops automatically after rewinding is complete.
5. Press the ▶/|| (PLAY/STILL) button to start playback.
  - You can view the picture you recorded on the LCD.
  - To stop the PLAY operation, press the ■ (STOP) button.

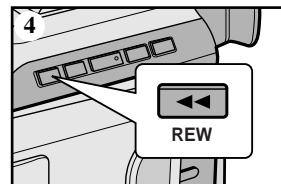
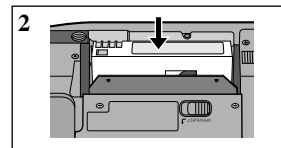
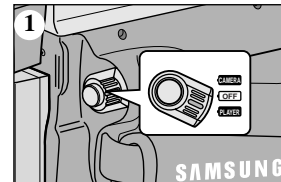

### Reference

- You can also view the picture on a TV screen, after connecting the camcorder to a TV or VCR. (see page 68)
- Various functions are available in playback mode. (see page 70)

## Basic Recording

### Adjusting the LCD during PLAY

- ☞ You can adjust the LCD during playback.
- ☞ The adjustment method is the same procedure as used in CAMERA mode. (see page 31)

### Controlling Sound from the Speaker

The Speaker works in PLAYER mode only.

- When you use the LCD screen for playback, you can hear the recorded sound from the built-in Speaker.
    - Follow the instructions below to decrease or mute speaker volume in the PLAYER mode.
    - Take the following steps to lower the volume or mute the sound while playing a tape on the camcorder.
1. Set the power switch to PLAYER mode.
  2. Press ►/|| (PLAY/STILL) to play the tape.
  3. When you hear sounds once the tape is in play, use the MENU DIAL to adjust the volume.
    - A volume level display will appear on the LCD.
    - Levels may be adjusted from anywhere between 00 to 19 and you will not hear any sound when the volume is set on 00.
    - If you close the LCD while playing, you will not hear sound from the speaker.

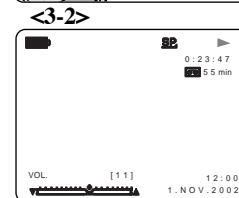
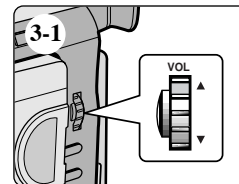
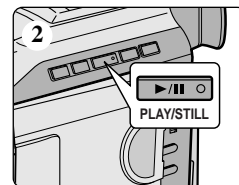

## Advanced Recording

### Use of various Functions

#### ● Setting menu items

MENU	SUB MENU	Available mode	
		CAMERA	PLAYER
INITIAL	CLOCK SET	✓	✓
	REMOCON	✓	✓
	BEEP SOUND	✓	✓
	DEMONSTRATION	✓	
CAMERA	PROGRAM AE	✓	
	WHT. BALANCE	✓	
	D. ZOOM	✓	
	EIS	✓	
	DSE SELECT	✓	
	CUSTOM. Q	✓	
A/V	REC MODE	✓	✓
	PHOTO SEARCH		✓
	AUDIO MODE	✓	✓
	AUDIO SELECT		✓
	WIND CUT	✓	✓
VIEWER	LCD ADJUST	✓	✓
	DATE/TIME	✓	✓
	TV DISPLAY	✓	✓

#### ● Set the camcorder to CAMERA or PLAYER mode

1. Press the MENU button.  
The MENU OSD is displayed. The cursor ( **HIGHLIGHT** ) indicates the feature you are currently adjusting.
2. Using the MENU DIAL and press the ENTER button on the left side panel, select and activate the item.
3. You can exit the menu mode by pressing the MENU button.

## Advanced Recording

● Availability of functions in each mode

Requested Operating Mode	Digital functions			Digital special effects	NIGHT CAPTURE
	EIS	D.ZOOM	PHOTO		
EIS		○	○	○	○
D.ZOOM	○		○	○	○
PHOTO	×	×		×	○
Digital Special Effects	○	○	○		△
NIGHT CAPTURE	○	○	○	×	

○ : The requested mode will work in this operating mode.

×

△ : The operating mode will be released and the requested mode will work.

**Reference**

- When a menu item on the LCD is marked with an X, that item cannot be activated.
- When you select an item that cannot be changed, an error message will be displayed.

## Advanced Recording

### ● CLOCK SET

- ⌘ CLOCK setup works in CAMERA and PLAYER modes.
- ⌘ The DATE/TIME is automatically recorded onto a tape.  
Before recording, please set the DATE/TIME.

1. Press the MENU button.
  - The menu list will appear.
2. Turn the MENU DIAL to highlight INITIAL and press the ENTER button.
3. Use the MENU DIAL to select CLOCK SET from the submenu.
4. Press the ENTER button to enter SETTING mode.
  - A blinking item indicates the item to be changed. The year will blink first.
5. Using the MENU DIAL, change the year setting.
6. Press the ENTER button.
  - The month will blink.
7. Using the MENU DIAL, change the month setting.
8. Press the ENTER button.
  - The day will blink.
9. You can set the day, hour and minute following the same procedure for setting the year and month.
10. Press the ENTER button after setting the minutes.
  - The word COMPLETE! will appear, and a few seconds later, the menu screen will automatically return to the sub menu.
11. To exit, press the MENU button.

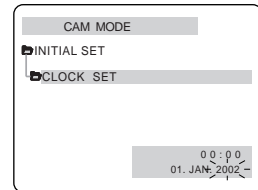
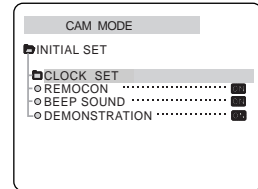
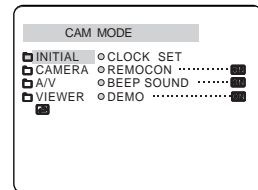

## Advanced Recording

---

### ● REMOCON

- ⌘ THE REMOCON function works in CAMERA and PLAYER modes.
- ⌘ The REMOCON option allows you to enable or disable the remote control for use with the camcorder.

1. Press the MENU button.
  - The menu list will appear.
2. Turn the MENU DIAL to highlight INITIAL and press the ENTER button.
3. Use the MENU DIAL to select REMOCON from the submenu.
4. Press the ENTER button to enable or disable the remote control.  
The setting switches between ON/OFF each time you press the ENTER button.
5. To exit, press the MENU button.
  - If you set the remote to OFF in the menu and try to use it, the remote icon will blink for 3 seconds and disappear on the LCD.

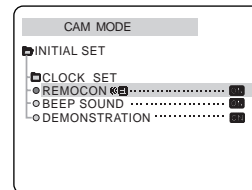
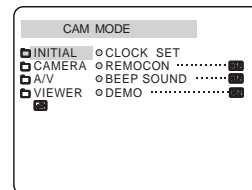

## Advanced Recording

### ● BEEP SOUND

- ⌘ THE BEEP SOUND function works in CAMERA and PLAYER modes.
- ⌘ Use the MENU to setup the BEEP SOUND function. Select whether or not you want to hear a beep sound whenever you change a setup value.

1. Press the MENU button.
  - The menu list will appear.
2. Turn the MENU DIAL to highlight INITIAL and press the ENTER button.
3. Use the MENU DIAL to select BEEP SOUND from the submenu.
4. Press the ENTER button to enable or disable the BEEP SOUND.
 

The setting switches between ON/OFF each time you press the ENTER button.

  - You will hear a Beep Sound when you select the ON setup.
  - When you press the START/STOP button to start recording, the BEEP SOUND is automatically set to OFF so you can't hear it any longer.
5. To exit, press the MENU button.

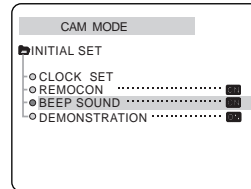
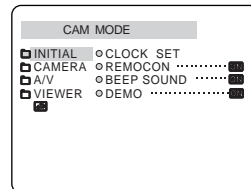

## Advanced Recording

### ● DEMONSTRATION

- ⌘ Demonstration automatically shows you the major functions that are included with your camcorder so that you may use them more easily.
- ⌘ The DEMONSTRATION function may only be used in the CAMERA mode without a tape inserted in the camcorder.
- ⌘ The demonstration operates repeatedly until the DEMONSTRATION mode switched OFF.

1. Set the camcorder to CAMERA mode.
2. Press the MENU button.
  - The menu list will appear.
3. Turn the MENU DIAL to highlight INITIAL.
4. Select DEMONSTRATION from the submenu and press the ENTER button.
5. To activate the DEMONSTRATION, set DEMONSTRATION ON.
  - Press the menu button to quit the menu.
  - The demonstration will begin.
6. To end the DEMONSTRATION, set the DEMONSTRATION to OFF.

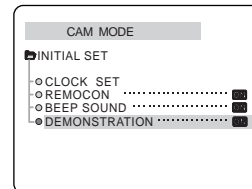
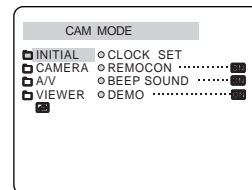

### Reference

- The DEMONSTRATION function only works without a TAPE installed.
- The DEMONSTRATION mode is automatically activated when the camcorder is left idle for more than 10 minutes after switching to the CAMERA mode (no tape is inserted in the camcorder).
- If you press other buttons (FADE, BLC, PHOTO, EASY, CUSTOM) during the DEMONSTRATION mode, the DEMONSTRATION stops temporarily and resumes 10 minutes later if you do not operate any other functions.



## Advanced Recording

---

### ● PROGRAM AE

- ⌘ The PROGRAM AE function works in CAMERA mode only.
- ⌘ The PROGRAM AE mode allows you to adjust shutter speeds and apertures to suit different recording conditions.
- ⌘ They give you creative control over the depth of field.

### ■ AUTO mode

- Auto balance between the subject and the background.
- To be used in normal conditions.
- The shutter speed automatically varies from 1/50 to 1/250 per second, depending on the scene.

### ■ SPORTS mode (⚡)

- For recording people or objects moving quickly.

### ■ PORTRAIT mode (👤)

- For focusing on the background of the subject, when the background is out of focus.
- The PORTRAIT mode is most effective when used outdoors.
- The shutter speed automatically varies from 1/50 to 1/1000 per second.

### ■ SPOTLIGHT mode (🎯)

- For recording correctly when there is only light on the subject and not the rest of the picture.

### ■ SAND/SNOW mode (❄️)

- For recording when people or objects are darker than the background because of reflected light from sand or snow.

### ■ HSS(High Speed Shutter) mode (🏏)

- For recording fast-moving subjects such as players in golf or tennis games.

# Advanced Recording

## Setting the PROGRAM AE

1. Press the MENU button.
  - The menu list will appear.
2. Turn the MENU DIAL to highlight CAMERA and press the ENTER button.
3. Select PROGRAM AE from the submenu.
4. Press the ENTER button to enter the sub-menu.
5. Using the MENU DIAL, select the PROGRAM AE mode.
  - Press the ENTER button to confirm the PROGRAM AE mode.
6. To exit, press the MENU button.

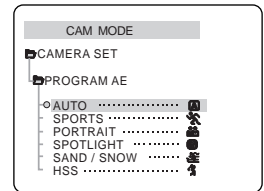
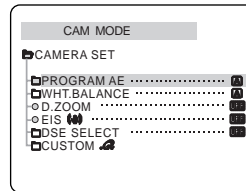
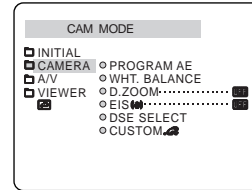

## Advanced Recording

### ● WHT. BALANCE (WHITE BALANCE)

- ⌘ The WHITE BALANCE function works in CAMERA mode only.
- ⌘ The WHITE BALANCE is a recording function that preserves the unique color of the object in any recording condition.
- ⌘ You may select the appropriate WHITE BALANCE mode to obtain good quality color of the image.
  - AUTO (☑) : This mode is generally used to control the WHITE BALANCE automatically.
  - HOLD (↓) : This fixes the current WHITE BALANCE value.
  - INDOOR (♣) : This controls the WHITE BALANCE according to the indoor ambience.
  - OUTDOOR (✱) : This controls the WHITE BALANCE according to the outdoor ambience.

1. Set the camcorder to CAMERA mode.
2. Press the MENU button.
  - The menu list will appear.
3. Turn the MENU DIAL to highlight CAMERA and press the ENTER button.
4. Select WHT.BALANCE from the submenu.
5. Press the ENTER button to enter the sub-menu.
6. Using the MENU DIAL, select the WHITE BALANCE mode.
  - Press the ENTER button to confirm the WHITE BALANCE mode.
7. To exit, press the MENU button.

### Reference

- While setting the NIGHT CAPTURE to ON, the WHT.BALANCE function does not work.
- The WHT.BALANCE function will not operate in EASY mode.
- Turn the digital zoom off (if necessary) to set a more accurate white balance.
- If you have set the white balance and lighting conditions changes, reset the white balance.
- During normal outdoor recording, setting to AUTO may provide better results.

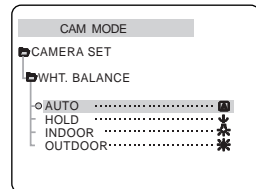
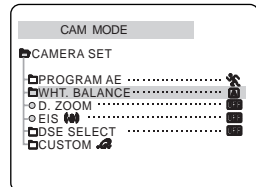
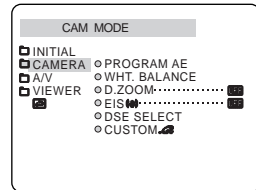

## Advanced Recording

### Zooming In and Out with DIGITAL ZOOM

- ⌘ Zoom works in CAMERA mode only.

### Zooming In and Out

- ⌘ Zooming is a recording technique that lets you change the size of the subject in a scene. For more professional looking recordings, do not use the zoom function too often.
  - ⌘ You can zoom using variable zoom speeds.
  - ⌘ Use these features for different shots. Please note that over-use of the zoom feature can lead to unprofessional looking results and a reduction of battery usage time.
1. Move the zoom lever slightly for a gradual zoom, move it further for a high-speed zoom.  
Your zooming is monitored on the OSD.
  2. T(Telephoto) side: Subject appears closer.
  3. W(Wide angle) side: Subject appears farther away.

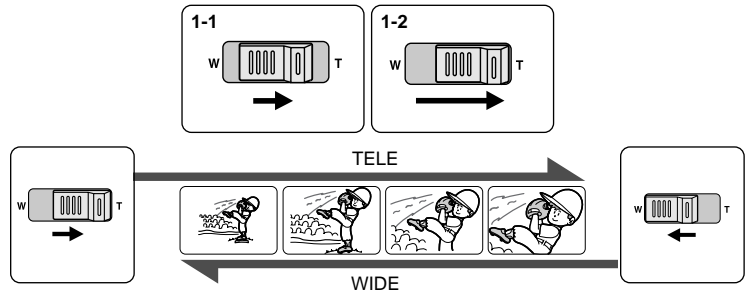

### Reference

You can record a subject that is a minimum of 1 m (about 2.65 feet) away from the lens surface in the TELE position, or about 10 mm (about 0.5 inch) away in the WIDE position.

## Advanced Recording

### Digital Zoom

- ⌘ More than 10x zoom is achieved digitally.
- ⌘ The picture quality may deteriorate depending on how much you zoom in on the subject.
- ⌘ We recommend that you use the EIS feature with DIGITAL ZOOM for picture stability. (see page 46)

1. Set the camcorder to CAMERA mode.
2. Press the MENU button.
  - The menu list will appear.
3. Turn the MENU DIAL to CAMERA and press the ENTER button.
4. Select D.ZOOM from the submenu.
5. Press the ENTER button to setup the 400x digital zoom function or to turn the feature OFF.
6. To exit, press the MENU button.

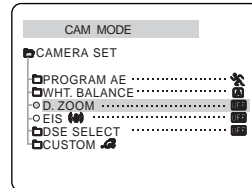
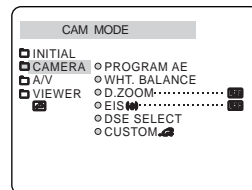

# Advanced Recording

## ● EIS (Electronic Image Stabilizer)

- ⌘ The EIS function works in CAMERA mode only.
- ⌘ EIS(Electronic Image Stabilizer) is a function that compensates for any shaking or hand movement while holding the camcorder (within reasonable limits).
- ⌘ It provides more stable pictures when:
  - Recording a small object close-up
  - Recording and walking at the same time
  - Recording through the window of a vehicle

1. Set the camcorder to CAMERA mode.
2. Press the MENU button.
  - The menu list will appear.
3. Turn the MENU DIAL highlight to CAMERA and press the ENTER button.
  - The sub menu list will appear.
4. Turn the MENU DIAL to activate the EIS function, press the ENTER button.
  - The EIS menu is changed to ON.
  - If you do not want to use the EIS function, set the EIS menu to OFF.
5. To exit, press the MENU button.

### Reference

- It is recommended that you deactivate the shake compensation function when using a tripod.

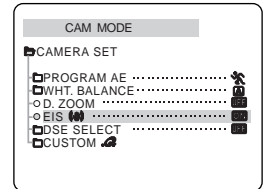
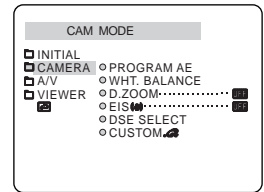

## Advanced Recording

### ● DSE(Digital Special Effects) SELECT

- ⌘ The DSE function works in CAMERA mode only.
- ⌘ The digital effects enable you to give a creative look to your recording by adding various special effects.
- ⌘ Select the appropriate digital effect for the type of picture that you wish to record and the effect you wish to create.
- ⌘ There are 9 DSE modes.

- a. ART mode  
This mode gives the images a coarse effect.
- b. MOSAIC mode  
This mode gives the images a mosaic effect.
- c. SEPIA mode  
This mode gives the images a reddish-brown pigment.
- d. NEGA mode  
This mode reverses the colours of the images, creating a negative image.
- e. MIRROR mode  
This mode cuts the picture in half, using a mirror effect.
- f. BLK & WHT mode  
This mode changes the images to black and white.
- g. EMBOSS mode  
This mode creates a 3D effect (embossing).
- h. CINEMA mode  
This mode covers the upper/lower portions of the screen to give a cinematic effect.
- i. MAKE - UP mode  
This mode allows the images to be selected in red, green, blue or yellow colours.

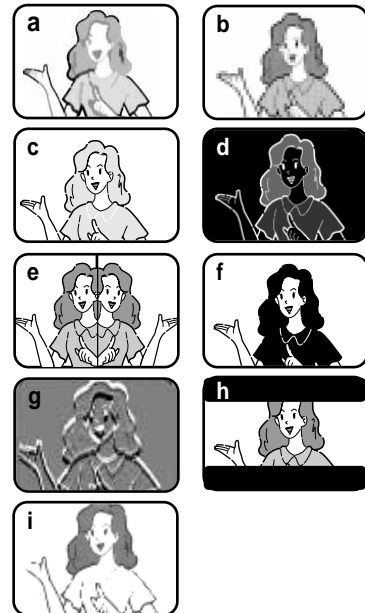

# Advanced Recording

## Selecting an effect

1. Set the camcorder to CAMERA mode.
2. Press the MENU button.
  - The menu list will appear.
3. Turn the MENU DIAL to highlight CAMERA and press the ENTER button.
4. Select DSE SELECT from the submenu.
5. Press the ENTER button to enter the sub-menu.
6. Using MENU DIAL, select the DSE mode.
  - Press the ENTER button to confirm the DSE mode.
7. To exit, press the MENU button.

## Reference

- While setting the NIGHT CAPTURE to ON, the DSE function does not work.
- The DSE function will not operate in EASY mode.

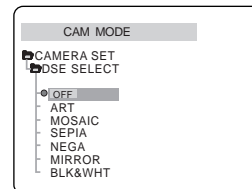
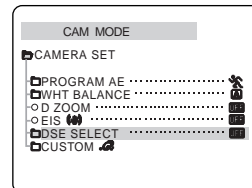
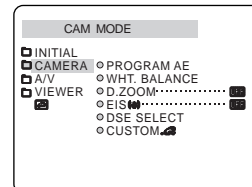



# Advanced Recording

## ● CUSTOM.Q

- ⌘ You can customize settings and save them for future use.
  - The CUSTOM.Q function operates in the CAMERA mode.
- ⌘ If you want to use the CUSTOM.Q function (see page 59) correctly, set the status of each item as desired before using the CUSTOM.Q function.
- ⌘ You can set and store the following items:
  - PROGRAM AE, WHT.BALANCE, D.ZOOM, EIS, DSE SELECT

1. Set the power switch to CAMERA mode.
2. Press the MENU button.
  - The MENU list will appear.
3. Turn the MENU DIAL, select CAMERA position and press the ENTER button.
4. Select CUSTOM.Q using MENU DIAL in the submenu and press the ENTER button.
5. Using the MENU DIAL and press the ENTER button, set the status of each item as desired.
6. To exit the menu, press the MENU button.

### Reference

- If you want to activate the CUSTOM.Q function, press the CUSTOM.Q button while in CAMERA mode.
- The PROGRAM AE mode is automatically setup when the EXPOSURE is set on manual.

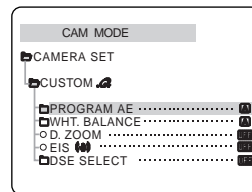
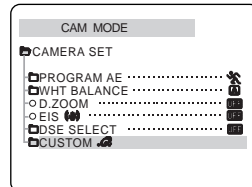
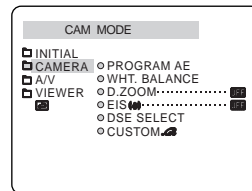

# Advanced Recording

## ● REC MODE

- ⌘ The REC MODE function works in both CAMERA and PLAYER modes.
- ⌘ This camcorder records and plays back in SP (standard play) mode and in LP (long play) mode.
  - SP (standard play): This mode permits 60 minutes of recording time with a DVM60 tape.
  - LP (long play): This mode permits 90 minutes of recording time with a DVM60 tape.

1. Set the camcorder to CAMERA or PLAYER mode.
2. Press the MENU button.
  - The menu list will appear.
3. Turn the MENU DIAL to highlight A/V and press the ENTER button.
4. Select REC MODE from the submenu and press the ENTER button.
  - The REC MODE toggles between SP and LP with each press.
5. To exit, press the MENU button.

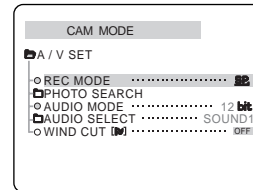
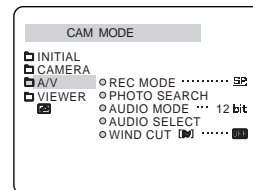

## Reference

- We recommend that you use this camcorder to play back any tapes recorded on this camcorder. Playing back a tape recorded in other equipment may produce mosaic shaped distortion.
- When you record a tape in SP and LP modes, or LP mode only, the playback picture may be distorted or the time code may not be written properly between scenes.
- Record using SP mode for best picture and sound quality.

## Advanced Recording

### ● AUDIO MODE

- ⌘ The AUDIO MODE function works in CAMERA and PLAYER modes.
- ⌘ This camcorder records sound in two ways. (12bit, 16bit)
  - 12bit : You can record two 12bit stereo sound tracks.  
The original stereo sound can be recorded onto the MAIN (SOUND1) track.  
Additional stereo sound can be dubbed onto the SUB (SOUND2) track.
  - 16bit : You can record one high quality stereo sound using the 16bit recording mode.  
Audio dubbing is not possible when using this mode.

1. Set the camcorder to CAMERA mode.
2. Press the MENU button.
  - The menu list will appear.
3. Turn the MENU DIAL to highlight A/V and press the ENTER button.
4. Select the AUDIO MODE from the menu and press the ENTER button.
  - The AUDIO MODE toggles between 12bit-16bit with each push.
5. To exit, press the MENU button.

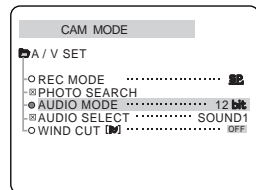
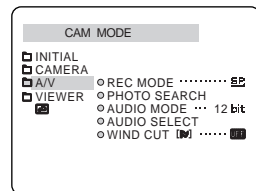

## Advanced Recording

### ● WIND CUT

- ⌘ The WIND CUT function works in CAMERA and PLAYER modes.
- ⌘ The WIND CUT function minimizes wind noise or other noise while recording.
  - When the wind cut is on, some low sounds are eliminated along with the sound of the wind.

1. Set the camcorder to CAMERA mode.
2. Press the MENU button.
  - The menu list will appear.
3. Turn the MENU DIAL to highlight A/V and press the ENTER button.
4. Select WIND CUT from submenu.
5. This feature toggles ON/OFF each time you press the ENTER button.
6. To exit, press the MENU button.

### Reference

- Make sure WIND CUT is set to off when you want the microphone to be as sensitive as possible.
- Use the WIND CUT when recording in windy places such as the beach or near buildings.

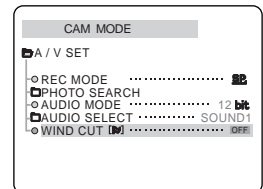
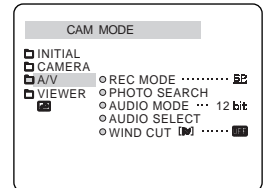

# Advanced Recording

## ● DATE/TIME

- ⌘ The DATE/TIME function works in CAMERA and PLAYER modes.
- ⌘ The date and time are automatically recorded on a special data area of the tape.

1. Press the MENU button.
  - The menu list will appear.
2. Turn the MENU DIAL to highlight VIEWER and press the ENTER button.
3. Turn the MENU DIAL to highlight DATE/TIME.
4. Press the ENTER button to select the sub-menu.
  - You can choose to display - the OFF, DATE, TIME, DATE/TIME
    - OFF only
    - DATE only
    - TIME only
    - DATE & TIME
  - To return to the previous menu, highlight the DATE/TIME in the middle of the and press the ENTER button.
6. To exit, press the MENU button.

### Reference

- The DATE/TIME is not affected by the OSD ON/OFF (DISPLAY) button.
- The DATE/TIME will read “- -” in the following conditions.
  - During playback of a blank section of a tape.
  - If the tape was recorded before setting the DATE/TIME in the Camera’s memory.
  - When the lithium battery becomes weak or dead.
- Before you can use the DATE/TIME function, you must set the Clock. See CLOCK SET on page 37.

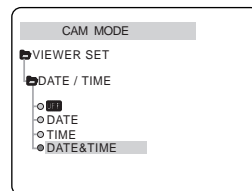
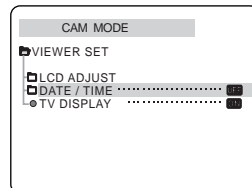
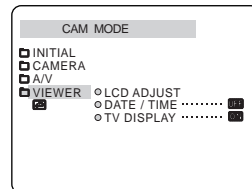

## Advanced Recording

---

### ● TV DISPLAY

- ⌘ The TV DISPLAY function works in CAMERA and PLAYER modes.
- ⌘ You can select the output path of the OSD (On Screen Display).
  - OFF: The OSD appears in the LCD screen only.
  - ON: The OSD appears in the LCD screen, EVF and TV.
  - Use the DISPLAY button located at the left side of the camcorder to turn ON/OFF all of the OSD displayed on the LCD/EVF/TV.

1. Set the camcorder to CAMERA, PLAYER mode.
2. Press the MENU button.
  - The menu list will appear.
3. Turn the MENU DIAL to highlight VIEWER and press the ENTER button.
4. Select the TV DISPLAY mode in list, press the ENTER button.
  - The DISPLAY mode switches between ON/OFF with each push.
5. To exit, press the MENU button.

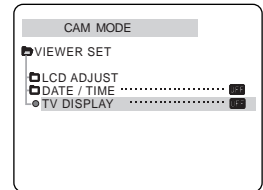
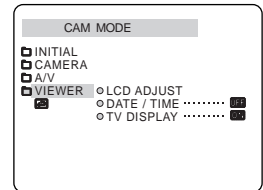

## Advanced Recording



### Using Quick Menu

- ⌘ Quick menu is available only in CAMERA mode.
- ⌘ Quick menu is used to adjust camera functions by simply using the MENU SELECTOR button.  
This feature is useful for when you want to make simple adjustments without having to access the menus and submenus.

#### ■ DATE/TIME

- Each time you select DATE/TIME and press the ENTER button, it will be displayed in the order of DATE - TIME - DATE/TIME - OFF(See page 53).

#### ■ REMOCON()

- Each time you select REMOCON and press the ENTER button, the REMOCON is switched to either enabled () or disabled () .

#### ■ EIS()

- Each time you select EIS and press the ENTER button, the EIS icon is displayed or set to OFF.

#### ■ DSE(Digital Special Effect) (see page 47)

- Each time you select DSE and press the ENTER button the DSE preset values are applied or set to OFF.  
DSE values will not switch between On and Off if they have not been preset in the menu.

#### ■ PROGRAM AE (see page 41)



- Each time you select PROGRAM AE and press the ENTER button, you can choose between the preset PROGRAM AE values and AUTO. You can't choose between Auto and the PROGRAM AE values if the values have not been preset in the regular menu.

# Advanced Recording

■ **WHT. BALANCE (see page 43)**

- Each time you select WHT. BALANCE and press the ENTER button, you can choose between preset WHT.BALANCE values and AUTO. As in PROGRAM AE, you can't choose between Auto and WHT.BALANCE values if they have not been preset.

■ **FOCUS (Manual Focus/Auto Focus) (see page 60)**

- Each time you select FOCUS and press the ENTER button, the FOCUS is switched to either Manual Focus (  ) or Auto Focus (  ).

■ **SHUTTER SPEED & EXPOSURE**



- You can set values for SHUTTER SPEED and EXPOSURE by selecting (  ) icon and pressing the MENU DIAL. For more information, see the next chapter.

**Setting the Quick menu**

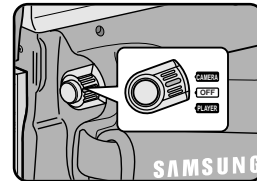
1. Set the camcorder to CAMERA mode.
2. Turn the MENU DIAL to select a function you want and then press the ENTER button to change the values.



**Reference**

- Quick menu function will not operate in EASY mode.
- If you are using the M.FOCUS(  ) function, you cannot use the Quick menu. If you want to use the Quick menu function, release the M.FOCUS(  ) mode.

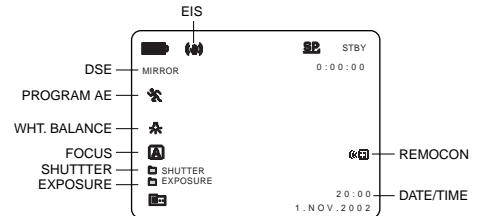





## Advanced Recording

---

### SHUTTER SPEED & EXPOSURE

- ⌘ You can set SHUTTER SPEED and EXPOSURE only in CAMERA mode.
- ⌘ SHUTTER SPEED and EXPOSURE values can only be set in the Quick Menu.
- ⌘ SHUTTER SPEED and EXPOSURE are automatically switched and/or deactivated.

1. Set the power switch to CAMERA mode.
2. Turn the MENU DIAL until you see  icon on, and then press the ENTER button.
  - You see a screen on which you can select SHUTTER SPEED and EXPOSURE.
  - Turn the MENU DIAL to select the item you want and then press the ENTER button.
  - SHUTTER SPEED can be set to 1/50, 1/120, 1/250, 1/500, 1/1000, 1/2000, 1/4000 or 1/10000.
  - EXPOSURE can be set between 00 and 29.
3. To exit from the setting screen, select the  icon and press the ENTER button.

### Reference

- If you want to use the selected shutter speed and exposure value, you should begin the recording with the shutter speed and the exposure adjustment screens displayed on the LCD.
- If you manually change the shutter speed and the exposure value when Auto-exposure option is selected, manual changes are applied first.

## Advanced Recording

### *EASY Mode (for Beginners)*

- ⚙ The EASY mode allows a beginner to make good recordings easily.
  - The EASY mode only operates in CAMERA mode.

1. Set the power switch to CAMERA mode.
2. By pressing the EASY button, all functions on the camera will be set to off and the recording settings will be set to the following basic modes:
  - Battery level, recording mode, counter, DATE/TIME, and EIS (👤) will be displayed.
  - The word “EASY.Q” will appear on the LCD at the same time.  
However, the DATE/TIME will only be seen if it has been previously set. (see page 53)
3. Press START/STOP to start recording.
  - Recording will begin using the basic automatic settings.
4. Pressing the EASY button again turns the EASY mode off.
  - The camera will return to the settings that were set prior to activating EASY mode.

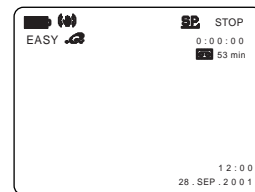
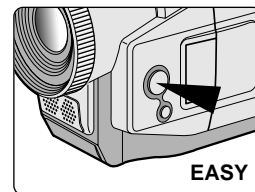

### Reference

- In EASY mode, certain functions are not available, such as MENU, BLC, MF/AF.
  - If you want to use these functions, you must first switch the EASY mode off.
- The EASY mode settings are deleted when the battery pack is uninstalled from the camcorder and therefore, they must be reset when a battery pack has been replaced.

## Advanced Recording

### CUSTOM Mode

- ⌘ You can customize settings and save them for future use.
  - The CUSTOM SET function operates in CAMERA mode only.
- ⌘ Please set the custom settings before using this function. (see page 49)

1. Set the power switch to CAMERA mode.
2. To activate the CUSTOM function, press the CUSTOM button.
  - "CUSTOM.Q" will be displayed on the screen.
3. Press START/STOP to start recording.
  - Recording will begin using the CUSTOM settings.
4. To switch CUSTOM mode off, press the CUSTOM button again.
  - The camcorder will revert to the settings that were set prior to custom mode being selected.

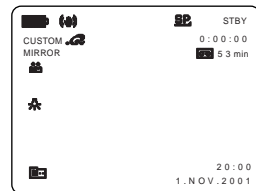
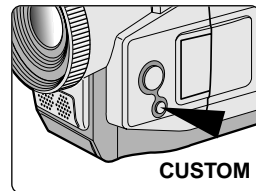

### Reference

- The CUSTOM mode settings are deleted when a battery pack is uninstalled and therefore they must be reset when a battery pack has been replaced.
- While setting the NIGHT CAPTURE to ON, the CUSTOM function does not work.

## Advanced Recording

### MF/AF (Manual Focus/Auto Focus)

- ⌘ The MF/AF function works in CAMERA mode only.
- ⌘ In most situations, it is better to use the automatic focus feature, as it enables you to concentrate on the creative side of your recording.
- ⌘ Manual focusing may be necessary under certain conditions that make automatic focusing difficult and/or unreliable.

### Auto Focusing

- ⌘ If you are inexperienced in the use of camcorders, we recommend that you make use of Auto Focus.

### Manual Focusing

- ⌘ In the following cases you may obtain better results by adjusting the focus manually.

- a. A picture containing several objects, some close to the camcorder, others further away.
- b. A person enveloped in fog or surrounded by snow.
- c. Very shiny or glossy surfaces like a car.
- d. People or objects moving constantly or quickly like an athlete or a crowd.

1. Set the power switch to CAMERA mode.
2. Turn the MENU DIAL and select the FOCUS menu.
3. Press the ENTER button.
4. Turn the MENU DIAL up or down until the object is in focus.
  - Zoom out a little if focusing is difficult.
5. To return to AF(Auto Focus: **A**), press the ENTER button again.

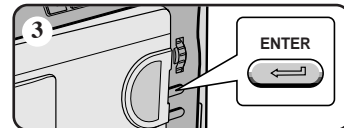
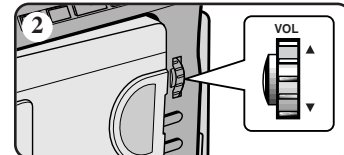
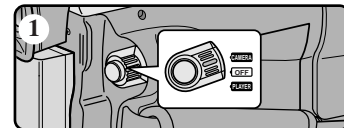
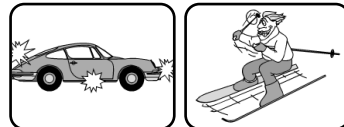

## Advanced Recording

### BLC (Back Light Compensation)

- ⌘ BLC works in CAMERA mode.
- ⌘ Back lighting exists when the subject is darker than the background:
  - The subject is in front of a window.
  - The person to be recorded is wearing white or shiny clothes and is placed against a bright background; the person's face is too dark to distinguish his/her features.
  - The subject is outdoors and the background is overcast.
  - The light sources are too bright.
  - The subject is against a snowy background.

1. Set the power switch to CAMERA mode.
2. Press the BLC button.
  - Normal - BLC - Normal
  - BLC enhances the subject.

#### Reference

- While setting the NIGHT CAPTURE to ON, the BLC function does not work.
- The BLC function will not operate in EASY mode.

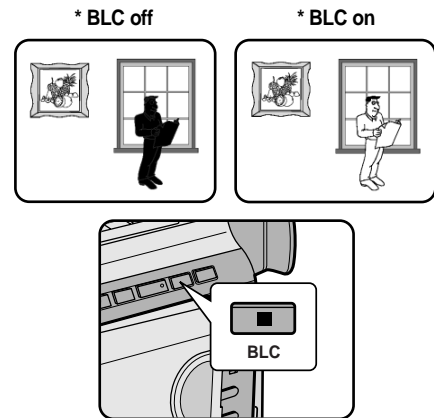

# Advanced Recording

## Fade In and Out

- ⚙ The FADE function works in CAMERA mode only.
- ⚙ You can give your recordings a professional look by using special effects such as fading in at the beginning of a sequence or fading out at the end of a sequence.

### To Start Recording

1. Before recording, hold down the FADE button. The picture and sound gradually disappear (fade out).
2. Press the START/STOP button and at the same time release the FADE button. Recording starts and the picture and sound gradually appear (fade in).

### To Stop Recording (use FADE IN / FADE OUT)

3. When you wish to stop recording, hold down the FADE button. The picture and sound gradually disappear (fade out).
4. When the picture has disappeared, press the START/STOP button to stop recording.

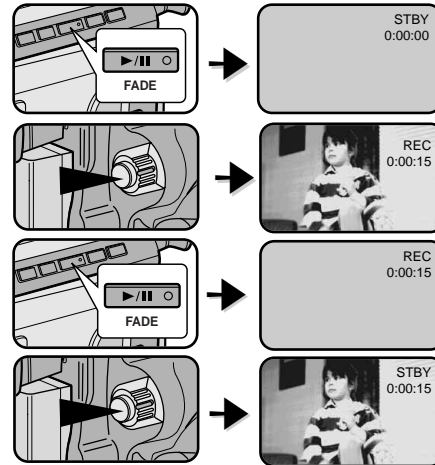

**a. FADE OUT** (Approx. 4 seconds)

**b. FADE IN** (Approx. 4 seconds)

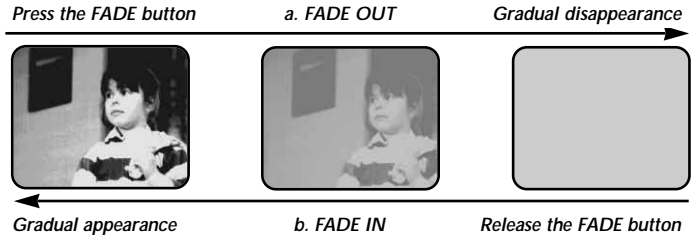

## Advanced Recording

### Audio dubbing

- ⌘ The AUDIO DUBBING function only works in PLAYER Mode.
- ⌘ You can add sound to the original sound on a pre-recorded tape, recorded in SP mode with 12bit sound.
- ⌘ Use the internal and external microphones or other audio equipment.
- ⌘ The original sound will not be erased.

### Dubbing sound

1. Set the camcorder to PLAYER mode.
  - If you want to use an external microphone, connect the microphone to the external MIC input jack on the camcorder.
  - When you wish to dub using the External A/V input, connect the AUDIO/VIDEO cable to the camcorder by inserting the cable jack into the A/V in/out terminal at the left side of the camcorder.
2. Press the ►/II (PLAY/STILL) button and find the timeframe of the scene to be dubbed.
3. Press the ►/II (PLAY/STILL) button to pause the scene.
4. Press the A.DUB button on the Remote Control.
  - A.DUB will be displayed on the LCD.
  - The camcorder is in a ready-to-dub state for dubbing.
5. Press the ►/II (PLAY/STILL) button to start dubbing.
  - Press the ■ (STOP) button to stop the dubbing.

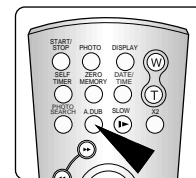
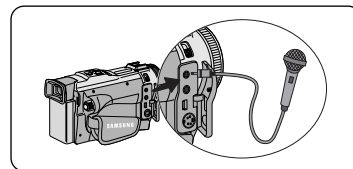

### Reference

- You can not use the audio dubbing function while playing a write protected video tape.
- When you wish to dub using the External A/V input, you must connect the AUDIO/VIDEO cable to the audio system from which you wish to record.
- You can not use the audio dubbing function while the A/V cable is connected to TV.

## Advanced Recording

### Dubbed audio Playback

1. Insert the dubbed tape and press MENU button.
2. Turn the MENU DIAL to highlight A/V.
3. Press the ENTER button to enter the sub-menu.
4. Use the MENU DIAL to select AUDIO SELECT from the submenu.
5. Press the ENTER button to enter the sub-menu.
6. Using the MENU DIAL, select the AUDIO playback channel.
  - Press the ENTER button to confirm the audio playback channel.
    - SOUND1 : play the original sound.
    - SOUND2 : play the dubbed sound.
    - MIX(1+2) : play back SOUND1 and 2 equally mixed.
7. To exit, press the MENU button.
8. Press the ►/|| (PLAY/STILL) button to playback the dubbed tape.

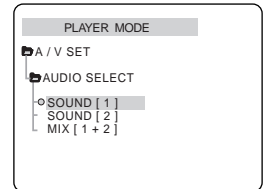
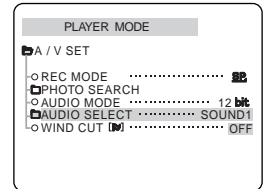

### Reference

When you playback added sound (SOUND2 or MIX mode), you may experience loss of sound quality.



# Advanced Recording

## PHOTO Image Recording

1. Press the PHOTO button and hold it.
  - The still picture appears on the LCD monitor.
  - If you do not wish to record, release the button.
2. Release the PHOTO button and press the PHOTO button again in 2 seconds.
  - The still picture is recorded for about 6~7 seconds.
3. After the PHOTO has been recorded, the camcorder returns to STBY mode.

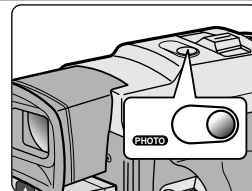

### Searching for a PHOTO picture

⌘ The PHOTO SEARCH works in PLAYER mode only.

1.
  - Press the PHOTO SEARCH button on the Remocon or,
  - Use the MENU.
    - a. Press the MENU button.
      - The MENU list will appear.
    - b. Turn the MENU DIAL to highlight A/V.
    - c. Press the ENTER button to enter the sub-menu.
    - d. Select PHOTO SEARCH from the sub-menu and press the ENTER button.
2. Search the PHOTO using the ►► (FWD) and ◀◀ (REW) buttons.
  - The PHOTO search process appears on the LCD while you are searching.
  - After completing the search, the camcorder displays the still image.
3. To exit, press the ■ (STOP) button.

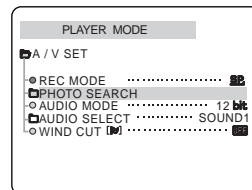
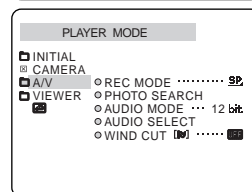

## Advanced Recording

### *NIGHT CAPTURE (0 lux recording)*

- ⌘ The NIGHT CAPTURE function works in CAMERA mode.
- ⌘ The NIGHT CAPTURE function enables you to record a subject in darkness.

1. Set the camcorder to CAMERA mode.
2. Slide the NIGHT CAPTURE switch to ON.
  - (Night Capture indicator) appears on the LCD monitor.
  - The infrared(invisible rays) light is turned on automatically.
3. To cancel the NIGHT CAPTURE function, slide the NIGHT CAPTURE switch to OFF.

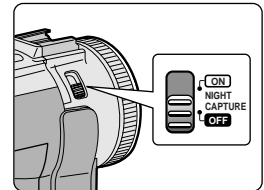

### Reference

- The maximum recording distance using the infrared light is about 3 m (about 10 feet).
- If you use the NIGHT CAPTURE function in normal recording situations (ex. outdoors by day), the recorded picture may contain unnatural colours.
- In the NIGHT CAPTURE mode, certain functions are not available, such as White Balance, Program AE, DSE, IRIS, SHUTTER SPEED, BLC, CUSTOM.

## Advanced Recording

### Various Recording Techniques

⌘ In some situations different recording techniques may be required for more dramatic results.

#### Reference

Please rotate the LCD screen carefully as excessive rotation may cause damage to the inside of the hinge that connects the LCD screen to the Camcorder.

#### 1. General recording.

#### 2. Downward recording.

Making a recording with a top view of the LCD screen.

#### 3. Upward recording.

Making a recording viewing the LCD screen from below.

#### 4. Self recording.

Making a recording viewing the LCD screen from the front.

#### 5. Recording with the Viewfinder.

- In circumstances where it is difficult to use the LCD monitor, the viewfinder can be used as a convenient alternative.

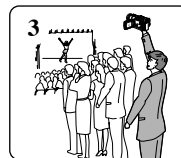
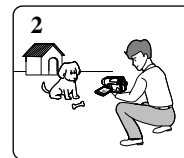

# Playback

## Tape Playback

⌘ The playback function works in PLAYER mode only.

### Playback on the LCD

⌘ It is practical to view a tape using the LCD in a car or outdoors.

### Playback on a TV monitor

⌘ To play back a tape, the television must have a compatible colour system.

⌘ We recommend that you use the AC Power Adapter as the power source for the camcorder.

### Connecting to a TV which has Audio/Video input jacks

1. Connect the camcorder and TV with the Audio/Video cable.
  - The yellow plug : Video
  - The white plug : Audio(L)
  - The red plug : Audio(R) - STEREO only
    - If you connect to a monaural TV or VCR, connect the yellow plug (Video) to the video input of the TV or VCR and the white plug (Audio L) to the audio input of the TV or VCR.
- ⌘ You may use the supplied SCART adapter.
2. Set the power switch on the camcorder to PLAYER mode.
3. Turn on the TV and set the TV/VIDEO selector on the TV to VIDEO.
  - Refer to the TV or VCR user's manual.
4. Play the tape back.

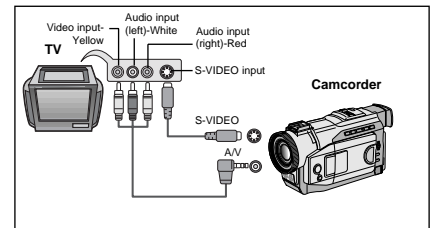

### Reference

- You may use the S-VIDEO cable to obtain better quality pictures if you have a S-VIDEO connector on your TV.
- Even if you use a S-VIDEO cable, you need to connect an audio cable.

## Playback

### Connecting to a TV which has no Audio and Video input jacks

⌘ You can connect your camcorder to a TV through a VCR.

1. Connect the camcorder and VCR with the Audio/Video cable.
  - The yellow plug : Video
  - The white plug : Audio(L)
  - The red plug : Audio(R) - STEREO only
2. Connect a TV to the VCR.
3. Set the power switch on the camcorder to PLAYER mode.
4. Turn on both the TV and VCR.
  - Set the input selector on the VCR to LINE.
  - Select the channel reserved for your VCR on the TV set.
5. Play the tape back.

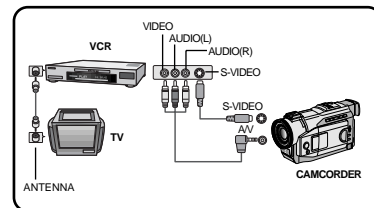

### Playback

⌘ You can play the recorded tape in PLAYER mode.

1. Connect a power source and set the power switch to PLAYER mode.
2. Insert the tape you wish to play back.
3. Using the ►► (FWD) and ◀◀ (REW) buttons, find the first position you wish to play back.
4. Press the ►/|| (PLAY/STILL) button.
  - The images you recorded will appear on the TV after a few seconds.
  - If a tape reaches its end while being played back, the tape will rewind automatically.

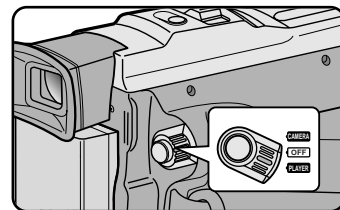

### Reference

- It is best to decrease the volume of the built-in speaker when your camcorder is connected to the TV.
- The playback mode (SP/LP) is selected automatically.

## Playback

### *Various Functions while in PLAYER mode*

- ⌘ The PLAY/STILL, STOP, FWD, REW buttons are located on the camcorder and the Remote Control.
- ⌘ The F.ADV(Frame advance), X2, SLOW buttons are located on the Remote Control only.
- ⌘ To prevent tape and head-drum wear, your camcorder will automatically stop if it is left in STILL or SLOW modes for more than 5 minutes.

### Playback pause

- ⌘ Press the ►/|| (PLAY/STILL) button during Playback or Slow playback.
- ⌘ To resume playback, press the ►/|| (PLAY/STILL) button.

### Picture search (Forward/Reverse)

- ⌘ Press the ►► (FWD) or ◀◀ (REW) buttons once during Playback or Still mode.  
To resume normal playback, press the ►/|| (PLAY/STILL) button.
- ⌘ Keep pressing ►► (FWD) or ◀◀ (REW) buttons during Playback or Still mode.  
To resume normal playback, release the button.

### Slow playback (Forward/Reverse)

- ⌘ Forward Slow Playback
  - Press the SLOW button on the remote control during Playback.
  - To resume normal playback, press the ►/|| (PLAY/STILL) button.
- ⌘ Reverse slow playback
  - Press the ◀◀ (-) button during Forward Slow Play back.
  - To resume forward slow playback, press the ||► (+) button.
  - To resume normal playback, press the ►/|| (PLAY/STILL) button.

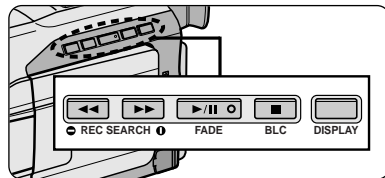

## Playback

### Frame advance (To play back frame by frame)

- Press the F.ADV button on the Remote Control while in Still mode. The F.ADV function works in still mode only.
- To resume normal playback, press the ►/|| (PLAY/STILL) button.
  - ⌘ Forward frame advance
    - Press the F.ADV button on the remote control in Still mode.
  - ⌘ Reverse frame advance
    - Press ◀|| (-) the button on the remote control to change the direction in F.ADV mode.
    - Press the F.ADV button on the remote control.

### X2 Playback (Forward/Reverse )

- ⌘ Forward X2 Playback
  - Press the X2 button on the Remote Control during Playback.
  - To resume normal playback, press the ►/|| (PLAY/STILL) button.
- ⌘ Reverse X2 Playback
  - Press ◀|| (-) the button during Forward X2 Playback
  - To resume normal playback, press the ►/|| (PLAY/STILL) button.

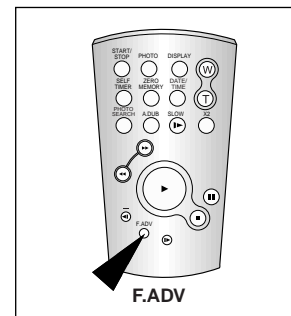

### Reference

- Mosaic shaped distortion may appear on the screen while in some of the various playback modes.
  - Mosaic shaped distortion or noise may be experienced when you play back tapes recorded in LP which contain various playback functions.
- Sound will only be heard during regular playback.

## Playback

---

### ZERO MEMORY

- ⌘ The MEMORY function works in both CAMERA and PLAYER modes.
  - ⌘ You can mark a point on a tape that you want to return to following playback.
1. Press the ZERO MEMORY button on the remote control during playback or recording at the point you wish to return to.
    - The time code is changed to a tape counter that is set to zero memory with the M 0:00:00(Zero memory indicator)
    - If you want to cancel the zero memory function, press the ZERO MEMORY button again.
  2. Finding the zero position.
    - When you have finished playback, fast forward or rewind the tape.
      - The tape stops automatically when it reaches the zero position.
    - When you have finished recording, press the power switch on the PLAYER and press the ◀◀ (REW) button.
      - The tape stops automatically when it reaches the zero position.
  3. The tape counter with the M (Zero memory indicator) disappears from the display and the tape counter is changed to the time code.

#### Reference

- In the following situations, ZERO MEMORY mode may be canceled automatically:
  - At the end of the section marked with the ZERO MEMORY function.
  - When the tape is ejected.
  - When you remove the battery pack or power supply.
- The zero memory may not function correctly where there is a break between recordings on the tape.
- The ZERO MEMORY will not operate in DV IN mode.



## Recording in PLAYER mode (VP-D80i/D81i only)

### Recording in *PLAYER mode*

- ⌘ You can use this camcorder as a recorder.
- ⌘ You can record a tape from VCR or TV.

1. Connect the camcorder and VCR or TV with the Audio/Video cable.
2. Set the power switch of the camcorder to *PLAYER mode*.
3. Turn on the VCR or TV.
4. Insert the blank tape with protection tab closed into the camcorder.
  - If you want to record from the connected VCR, insert a recorded VHS tape into the VCR.
5. Press the *START/STOP* button to set the camcorder to *REC PAUSE mode*.
  - "PAUSE" and picture appear on the LCD monitor.
6. Select the TV program or playback the VHS tape.
7. Press *START/STOP* button to start recording.
  - If you want to pause recording for a while, press the *START/STOP* button again.
8. To stop recording, press the ■ (*STOP*) button.

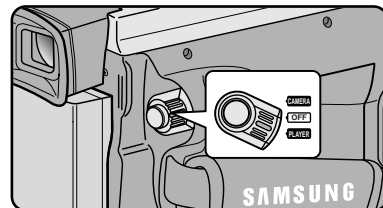
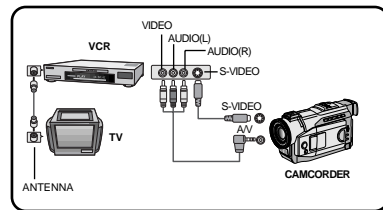

## IEEE 1394 Data Transfer

---

### *Transferring IEEE1394 (i.LINK)-DV standard data connections*

#### Connecting to a DV device

- ⌘ Connecting with other DV standard products.
  - A standard DV connection is quite simple.
    - If a product has a DV port, you can transfer data by connecting to the DV port using the correct cable.
- !!! Please be careful since there are two types of DV ports, (4pin, 6pin). This camcorder has a 4pin terminal.
- ⌘ With a digital connection, video and audio signals are transmitted in digital format, allowing high quality images to be transferred.

#### Connecting to a PC

- ⌘ If you want to transmit data to a PC, you must install a IEEE 1394 add-on card onto the PC. (not supplied)
- ⌘ The frame rate recorded for video capturing is dependent on the capacity of the PC.

#### Reference

- When you transmit data from the camcorder to another DV device, some functions may not work.
  - If this occurs, please reconnect the DV cable or turn the power OFF and ON again.
- VP-DXXi can receive digital data from another DV device.
- You can record a picture transferred over a DV connection on VP-DXXi.

## IEEE 1394 Data Transfer

### ● System requirements

- CPU : faster Intel® Pentium III™ 450Mhz compatible.
- Operating system : Windows® 98SE, ME, XP, Mac OS
- Main memory : more than 64 MB RAM
- IEEE1394 add-on card or built in IEEE1394 card

### Recording with a DV connection cable (VP-DXXi only)

1. Set the power switch to PLAYER mode.
2. Connect the DV cable (not supplied) from the DV IN/OUT port of the camcorder to the DV IN/OUT port of the other DV device.
  - Make sure that DV IN appears on the screen.
3. Press the START/STOP button to begin REC PAUSE mode.
  - PAUSE is displayed on the OSD.
4. Start playback on the other DV device while you monitor the picture.
5. Press the START/STOP button to start recording.
  - If you want to pause recording momentarily, press the START/STOP button again.
6. To stop recording, press the ■ (STOP) button.

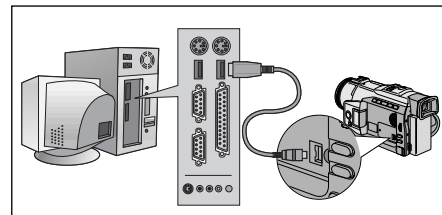

### Reference

When using this camcorder as a recorder, the pictures that appear on a monitor may seem uneven, however recorded pictures will not be affected.

## USB interface (VP-D81/D81i only)

---

### ● Transferring a Digital Image through a USB Connection

- ⌘ You can easily transfer a still image from a camera, tape, memory to a PC without additional add-on cards via a USB connection.
- ⌘ You can transfer an image to a PC via a USB connection.
- ⌘ If you transfer data to a PC, you need to install the software (Driver, Editing software) supplied with the camcorder.

### System Requirements

- CPU : Intel® Pentium II™ 400 processor compatible or better
- Operating system : Windows® 98/98SE/ME/2000/XP
- RAM : 64 MB or more
- CD-ROM: 4x CD-ROM drive
- VIDEO : 65,000-colour or better video display card
- Available USB port
- Hard Disc : 4GB (8GB recommended)

### Reference

- Intel® Pentium II™ is a trademark of the Intel Corporation.
- Windows® is a registered trademark of the Microsoft® Corporation.
- All other brands and names are property of their respective owners.

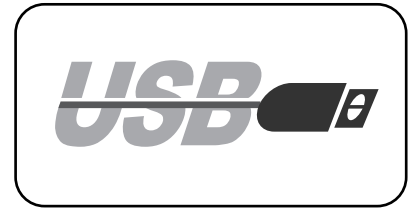

## USB interface (VP-D81/D81i only)

### Installing DVC Media Program

- ⌘ Do not connect the camcorder to PC before installing the program.
- ⌘ If another camera or scanner is connected, please disconnect it in advance.
- ⌘ This explanation is based on Windows® 98SE OS.

### How to install the program

1. The install program automatically operates when the CD is inserted into CD-ROM drive.



### Note

- If the install program does not operate, please double click Install.exe in CD-ROM Drive.
2. Click  to install the program.
  3. Follow the installation instructions.

## USB interface (VP-D81/D81i only)

- The window below displays the folder to install the program.
  - The program is installed in the following folder.  
C:\Programfiles\Samsung\DVC Media 3.0
  - Click  to change the folder.

- Connect the camcorder to PC.
- PC finds new hardware and installs a driver automatically.
- If the driver is installed, the installation is complete.
- Execute DVC Media 3.0 player on the Windows wall paper.

### Note

- DVC Media 3.0 User's Manual is included on the accompanying CD in Adobe's Portable Document Format (PDF). The user's manual can be viewed using Acrobat Reader software, which is also included on the CD. (The Acrobat Reader is a freeware product of Adobe Systems, Inc.)

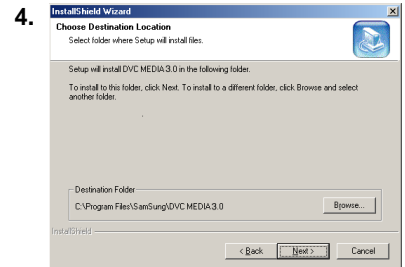

## USB interface (VP-D81/D81i only)

### Connecting to a PC

1. Connect a USB cable to the USB port on the PC.
2. Connect the other end of the USB cable into the proper terminal on the camcorder. (USB jack)
3. Connect the audio cable to the Line input jack of the PC.  
If the PC has no Line input jack, connect the audio cable to the MIC input jack.  
There is a possibility you'll here some audio noise if you use the MIC jack.

### Notes

- If you disconnect the USB cable from the PC or the camcorder while transferring, the data transmission will stop and the data may be damaged.
- If you connect the USB cable to a PC via a USB HUB or simultaneously connect the USB cable along with other USB devices, the camcorder may not work properly.
  - If this occurs, remove all USB devices from the PC and reconnect the camcorder.

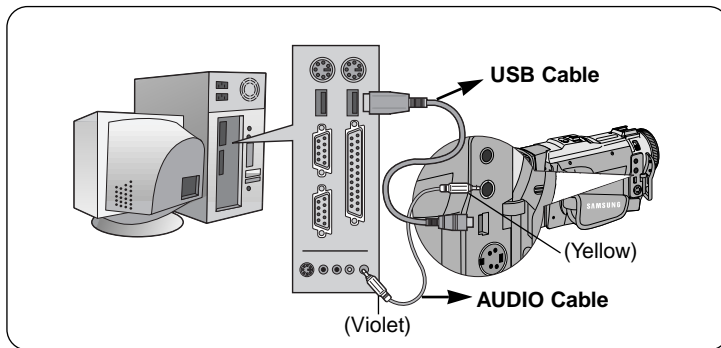

## Maintenance

### *After finishing a recording*

- ⚠ At the end of a recording you must remove the power source.
- ⚠ When recording with a Lithium Ion Battery Pack, leaving the pack on the camcorder can reduce the life span of the battery. Hence, it should be removed from the camcorder.

1. Slide the TAPE EJECT switch in the direction of the arrow.
  - Opening the cassette door ejects the tape automatically.
  - Please wait while the tape is completely ejected.
2. After removing the tape, close the door and store the camcorder in a dust free environment.
  - Dust and other foreign materials can cause square-shaped noise or jerky images.
3. Set the power switch to the OFF mode.
4. Disconnect the power source or remove the Lithium Ion Battery Pack.
  - Hold down the BATTERY RELEASE button and slide the battery pack in the direction of the arrow.

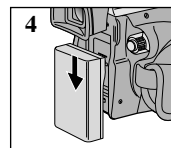
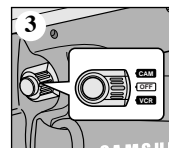
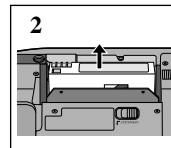
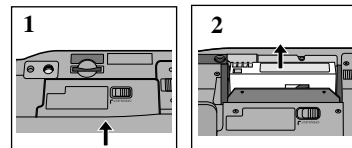



# Maintenance

## Cleaning and Maintaining the Camcorder

### Cleaning the VIEWFINDER

#### ● Releasing the eyecup

1. Pull the VIEWFINDER out and lift it up.
2. Turn the two screws counter-clockwise and pull the EYECUP out.
3. Clean the EYECUP and the VIEWFINDER screen with a soft cloth and cotton swab or a blower.

#### ● Reattaching the EYECUP

4. Put the EYECUP on the VIEWFINDER.
5. Refit the screws.

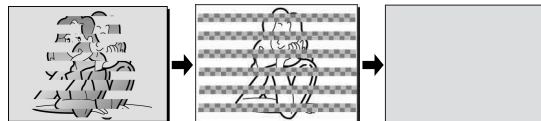
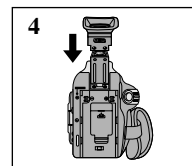
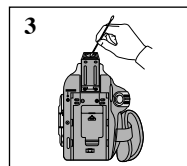
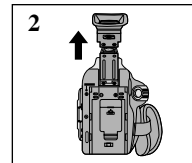
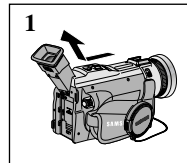

### Cleaning the Video Heads

To ensure normal recording and clear pictures, clean the video heads when the playback pictures display square block-shaped noise or distortion or if only a blue screen appears during playback, as the video heads may be dirty.

1. Set the power switch to PLAYER mode.
2. Insert the cleaning tape.
3. Press the ►/II (PLAY/STILL) button.
4. Press the ■ (STOP) button after 10 seconds.

### Reference

- Check the quality of the picture using a videocassette.  
If the picture quality has not improved, repeat the operation.  
If the problem continues, contact your local authorized service center.
- Clean the video heads with a dry type cassette cleaner.

## Maintenance

---

### *Using Your Camcorder Abroad*

- ⌘ Each country or region has its own electric and colour systems.
- ⌘ Before using your camcorder abroad, check the following items.

#### **Power sources**

- You can use your camcorder in any country or area with the supplied AC Power Adapter within 100V to 240V, 50/60 Hz.
- Use a commercially available AC plug Adapter, if necessary, depending on the design of the local wall outlet.

#### **Colour system**

- You can view your recording in the viewfinder.  
However, to view it on a television or copy it to a videocassette recorder, the television or VCR must be PAL-compatible and have the appropriate audio/video jacks.  
Otherwise, you may need to use a transcoder.

#### ● **PAL-compatible Countries/Regions**

Australia, Austria, Belgium, Bulgaria, China, CIS, Czech Republic, Denmark, Egypt, Finland, France, Germany, Greece, Great Britain, Holland, Hong Kong, Hungary, India, Iran, Iraq, Kuwait, Libya, Malaysia, Mauritius, Norway, Romania,, Saudi Arabia, Singapore, Slovak Republic, Spain, Sweden, Switzerland, Syria, Thailand, Tunisia, etc.

#### ● **NTSC-compatible Countries/Regions**

Bahamas, Canada, Central America, Japan, Mexico, Philippines, Korea, Taiwan, United States of America, etc.

#### **Reference**



You can make recordings with your camcorder and view pictures on the LCD from anywhere in the world.

# Troubleshooting

## Troubleshooting

- ⚠ Before contacting a Samsung authorized service centre, perform the following simple checks. They may save you the time and expense of an unnecessary call.

### Self Diagnosis Display

Display	Blinking	Informs that...	Action
	slow	the battery pack is almost discharged.	Change to a charged one.
TAPE END!	slow	When the remaining time on the tape is about 2 minutes	Prepare a new one.
TAPE END!	no	the tape reached its end.	Change to a new one.
TAPE!	slow	there is no tape in camcorder.	Insert a tape.
PROTECTION	slow	the tape is record protected.	If you want to record, release the protection.
▲...D L C R	slow	the camcorder has some mechanical fault.	1. Eject the tape. 2. Set to OFF. 3. Detach the battery. 4. Reattach the battery. * If unresolved contact your local service representative.
	slow	moisture condensation has formed in the camcorder.	see below.

### Moisture Condensation

- ⚠ If the camcorder is brought directly from a cold place to a warm place, moisture may condense inside the camcorder, on the surface of the tape, or on the lens. In this condition, the tape may stick to the head drum and be damaged or the unit may not operate correctly.  
To prevent possible damage under these circumstances, the camcorder is fitted with a moisture sensor.
- ⚠ If there is moisture inside the camcorder,  (DEW) is displayed. If this happens, none of the functions except cassette ejection will work.  
Open the cassette compartment and remove the battery.  
Leave the camcorder for at least two hours in a dry warm room.

# Troubleshooting

⚠ If these instructions do not solve your problem, contact your nearest Samsung authorized service centre.

Symptom	Explanation/Solution
You cannot switch the camcorder on.	Check the battery pack or the AC Power Adapter.
START/STOP button does not operate while recording.	Check the POWER switch is set to CAM. You have reached the end of the cassette. Check the record protection tab on the cassette.
The camcorder goes off automatically.	You have left the camcorder set to STBY for more than 5 minutes without using it. The battery pack is fully exhausted.
The battery pack is quickly exhausted.	The atmospheric temperature is too low. The battery pack has not been charged fully. The battery pack is completely dead, and cannot be recharged, Use another battery pack.
When you see a blue screen during playback.	The video heads may be dirty. Clean the head with a cleaning tape.
A vertical strip appears on the screen when recording a dark background.	The contrast between the subject and the background is too great for the camcorder to operate normally. Make the background bright to reduce the contrast or use the BLC function while you are recording brighter.
The image in the viewfinder is blurred.	The Viewfinder lens has not been adjusted. Adjust the viewfinder control lever until the indicators displayed on the viewfinder come into sharp focus.
Auto focus does not work.	Check the M.FOCUS menu. Auto focus does not work in the Manual Focus mode.
Play, FF or REW button does not work.	Check the POWER switch. Set the power switch to PLAYER. You have reached the beginning or end of the cassette.
When you see a broken block image during the RECORD SEARCH.	This is normal operation and it is not a failure or defect.

# Specifications

**Model name: VP-D80/D80i/D81/D81i**

<b>System</b>	
Video signal	PAL, CCIR standards
Video recording system	2 rotary heads, Helical scanning system
Audio recording system	Rotary heads, PCM system
Usable cassette	Digital video tape (6.35mm width): Mini DV cassette
Tape speed	SP: approx. 18.83mm/s LP: approx. 12.57mm/s
Tape recording time	SP: 60 minutes (when using DVM 60), LP: 90 minutes (when using DVM 60)
FF/REW time	Approx. 180 sec. (using DVM60 tape)
Image device	CCD (Charge Coupled Device)
Lens	F1.4 10x(Optical), 400x(Digital) Electronic zoom lens
Filter diameter	Ø37
<b>LCD monitor/Viewfinder</b>	
Size/dot number	2.5inch/112,000
LCD monitor Method	TFT LCD
Viewfinder	0.24" B/W LCD
<b>Connectors</b>	
Video output	1Vp-p (75Ω terminated)
S-video output	Y: 1Vp-p, 75Ω, C: 0.286Vp-p, 75Ω
Audio output	-7.5dBs (600Ω terminated)
DV input/output	VP-DXXi: 4pin special in/out connector, VP-DXX: out only
USB output	Mini-B type connector
External mic	Ø3.5 stereo

<b>General</b>	
Power source	DC 8.4V, Lithium Ion Battery Pack 7.4V
Power source type	Lithium Ion Battery Pack, Power supply (100V~240V) 50/60Hz
Power consumption (Recording)	4.9W(LCD), 3.6W(EVF)
Operating temperature	0°~40°C (32°F~104°F)
Storage temperature	-20°C ~ 60°C (-4°F ~ 140°F)
External dimension	Length 7inches(178mm), Height 3.54inches(90mm), Width 2.48inches(63mm)
Weight	1.19lbs(540g) (Except for Lithium Ion Battery Pack and tape)
Built-in MIC	Omni-directional stereo condenser microphone
Remote control	Indoors: greater than 49ft(15m) (straight line), Outdoors: greater than 16.4ft(5m) (straight line)

- These technical specifications and design may be changed without notice.

# ENGLISH

## INDEX

<b>- A -</b>	
Accessories .....	12
Audio dubbing .....	63
AUDIO MODE .....	51
<b>- B -</b>	
Battery Pack .....	24
BEEP .....	39
BLC .....	61
<b>- C -</b>	
Cassette .....	27
Cleaning .....	81
CLOCK SET .....	37
Connecting .....	69
CUSTOM Mode .....	59
CUSTOM.Q .....	49
<b>- D -</b>	
DATE/TIME .....	53
DC Cable .....	23
DEMONSTRATION .....	40
DSE .....	47
DV .....	74, 75
<b>- E -</b>	
EASY Mode .....	58
Edit Search .....	29
EIS .....	46
EXPOSURE .....	57
<b>- F -</b>	
Fade .....	62
Frame advance .....	71
Functions buttons .....	14
<b>- H -</b>	
Hand Strap .....	22
<b>- I -</b>	
IEEE1394 .....	74

<b>- L -</b>	
LCD .....	30, 31
<b>- M -</b>	
MF/AF .....	60
<b>- O -</b>	
OSD .....	18, 19
<b>- P -</b>	
PHOTO SEARCH .....	65
PROGRAM AE .....	41
<b>- Q -</b>	
Quick Menu .....	55
<b>- R -</b>	
REC MODE .....	50
REMOCON .....	38
Remote control .....	17, 20
<b>- S -</b>	
SHUTTER SPEED .....	57
Sound .....	34
Speaker .....	34
<b>- T -</b>	
TV DISPLAY .....	54
<b>- U -</b>	
USB .....	76
<b>- V -</b>	
Viewfinder .....	30, 32
<b>- W -</b>	
WHT. BALANCE .....	43
WIND CUT .....	52
<b>- Z -</b>	
ZERO MEMORY .....	72
Zoom .....	44, 45

## Power Sources (United Kingdom Only)

---

The mains lead on the power adapter is supplied with a moulded plug incorporating a fuse.

The value of the fuse is indicated on the pin face of the plug and, if it requires replacing, a fuse approved to BS1362 of the same rating must be used.

Never use the plug with the fuse cover omitted if the cover is detachable.

If a replacement fuse cover is required, it must be of the same colour as the pin face of the plug.

Replacement covers are available from your dealer.

If the fitted plug is not suitable for the power points in your house or the cable is not long enough to reach a power point, you should obtain a suitable safety approved extension lead or consult your dealer for assistance.

However, if there is no alternative to cutting off the plug, remove the fuse and then safely dispose of the plug.

Do NOT connect the plug to a mains socket as there is a risk of shock hazard from the bared flexible cord.

### IMPORTANT

The wires in the mains lead are coloured in accordance with the following code:

BLUE = NEUTRAL                      BROWN = LIVE

As these colours may not correspond to the coloured markings identifying the terminals in your plug, proceed as follows:

The wire coloured BLUE must be connected to the terminal marked with the letter N or coloured BLUE or BLACK.

The wire coloured BROWN must be connected to the terminal marked with the letter L or coloured BROWN or RED.

### WARNING

Do not connect either wire to the earth terminal marked with the letter E or the earth symbol,  $\perp$ , or coloured GREEN or GREEN and YELLOW.

### NOTE

This page is applicable to Great Britain only.

**ENGLISH**

**THIS CAMCORDER IS MANUFACTURED BY:**

