

MACKIE

1402-VLZ PRO 14-CHANNEL MIC/LINE MIXER OWNER'S MANUAL

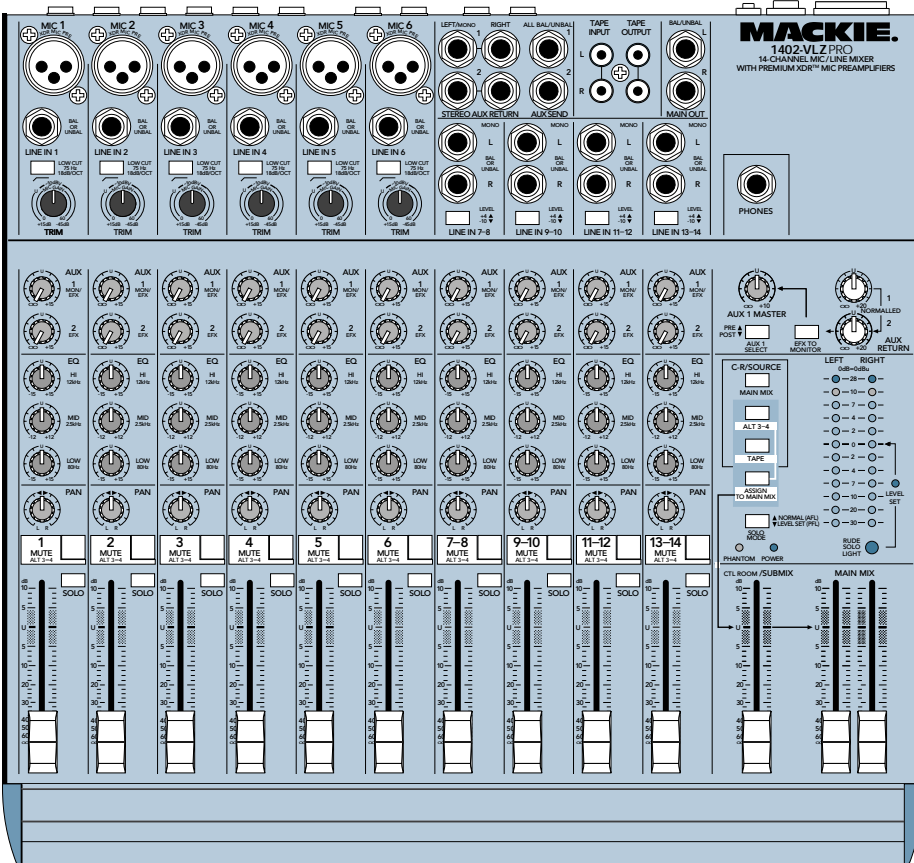

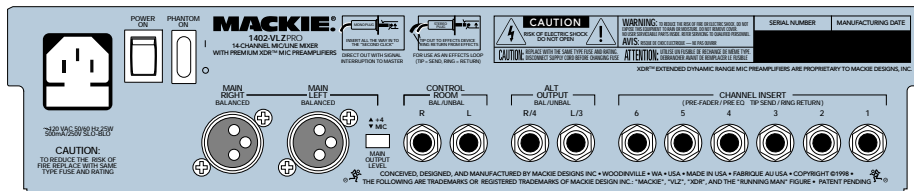
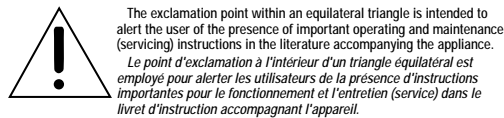
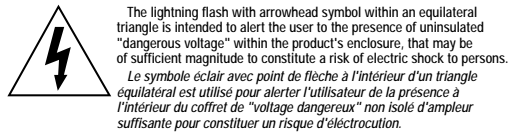

SAFETY INSTRUCTIONS

- 1. Read Instructions** — All the safety and operation instructions should be read before this Mackie product is operated.
- 2. Retain Instructions** — The safety and operating instructions should be kept for future reference.
- 3. Heed Warnings** — All warnings on this Mackie product and in these operating instructions should be followed.
- 4. Follow Instructions** — All operating and other instructions should be followed.
- 5. Water and Moisture** — This Mackie product should not be used near water — for example, near a bathtub, washbowl, kitchen sink, laundry tub, in a wet basement, near a swimming pool, swamp or salivating St. Bernard dog, etc.
- 6. Heat** — This Mackie product should be situated away from heat sources such as radiators, or other devices which produce heat.
- 7. Power Sources** — This Mackie product should be connected to a power supply only of the type described in these operation instructions or as marked on this Mackie product.
- 8. Power Cord Protection** — Power supply cords should be routed so that they are not likely to be walked upon or pinched by items placed upon or against them, paying particular attention to cords at plugs, convenience receptacles, and the point where they exit this Mackie product.
- 9. Object and Liquid Entry** — Care should be taken so that objects do not fall into and liquids are not spilled into the inside of this Mackie product.

10. Damage Requiring Service — This Mackie product should be serviced only by qualified service personnel when:

- The power-supply cord or the plug has been damaged; or
- Objects have fallen, or liquid has spilled into this Mackie product; or
- This Mackie product has been exposed to rain; or
- This Mackie product does not appear to operate normally or exhibits a marked change in performance; or
- This Mackie product has been dropped, or its chassis damaged.

11. Servicing — The user should not attempt to service this Mackie product beyond those means described in this operating manual. All other servicing should be referred to the Mackie Service Department.

12. To prevent electric shock, do not use this polarized plug with an extension cord, receptacle or other outlet unless the blades can be fully inserted to prevent blade exposure.

Pour prévenir les chocs électriques ne pas utiliser cette fiche polarisée avec un prolongateur, un prise de courant ou une autre sortie de courant, sauf si les lames peuvent être insérées à fond sans laisser aucune partie à découvert.

13. Grounding or Polarization — Precautions should be taken so that the grounding or polarization means of this Mackie product is not defeated.

14. This apparatus does not exceed the Class A/Class B (whichever is applicable) limits for radio noise emissions from digital apparatus as set out in the radio interference regulations of the Canadian Department of Communications.

ATTENTION — Le présent appareil numérique n'émet pas de bruits radioélectriques dépassant les limites applicables aux appareils numériques de class A/de class B (selon le cas) prescrites dans le règlement sur le brouillage radioélectrique édicté par les ministere des communications du Canada.

15. To prevent hazard or damage, ensure that only microphone cables and microphones designed to IEC 268-15A are connected.

WARNING — To reduce the risk of fire or electric shock, do not expose this appliance to rain or moisture.

READ THIS PAGE!!!

We realize that you must be dying to try out your new Mackie 1402-VLZ PRO. Or you might be one of those people that never read manuals. Either way, all we ask is that you read this page NOW, and the rest can wait until you're good and ready. But do read it — you'll be glad you did.

1 LEVEL-SETTING PROCEDURE

Message to seasoned pros: **do not** set levels using the old "Turn the trim up until the clip light comes on, then back off a hair" trick. When a Mackie Designs mixer clip light comes on, you really are about to clip. We worked and slaved to come up with a better system, one that provides low noise and high headroom.

Adjusting input levels (Channels 1–6 only)

On the first six channels, it's not even necessary to hear what you're doing to set optimal levels. But if you'd like to: Plug headphones into the PHONES jack, then set the CTL ROOM/SUBMIX fader about one quarter of the way up.

The following steps must be performed one channel at a time:

1. Turn the TRIM, AUX SEND and FADER controls fully down.
2. Set the EQ knobs at the center detent.
3. Connect the signal source to the input.
4. Engage (push in) the SOLO switch.
5. Engage the AFL/PFL switch in the master section. A green LEVEL SET light will congratulate you.
6. Play something into the selected input. This could be an instrument, a singing or speaking voice, or a line input such as a CD player or tape recorder output. Be sure that the volume of the input is the same as it would be during normal use. If it isn't, you might have to readjust these levels during the middle of the set.
7. Adjust the channel's TRIM control so that the display on the LED meters stays around "0" and never goes higher than "+7."
8. If you'd like to apply some EQ, do so now and return to step 7.
9. Disengage that channel's SOLO switch.
10. Repeat for each of Channels 1–6.

Other Nuggets of Wisdom

For optimum sonic performance, the channel and MAIN MIX FADERS should be set near the "U" (unity gain) markings.

Always turn the MAIN MIX and CTL ROOM/SUBMIX faders down before making connections to and from your 1402-VLZ PRO.

If you shut down your equipment, turn off your amplifier(s) first. When powering up, turn on your amplifier(s) last.

Save the shipping box! You may need it someday, and you don't want to have to pay for another one.



INSTANT MIXING

Here's how to get going right away, assuming you own a microphone and a keyboard:

1. Plug your microphone into Channel 1's MIC IN.
2. Turn on the 1402-VLZ PRO.
3. Perform the **Level Setting Procedure 1**.
4. Connect cords from the MAIN OUTPUTS (XLR, 1/4" or RCA, your choice) to your amplifier.
5. Hook up speakers to the amp and turn it on.
6. Turn up the 1402-VLZ PRO's Channel 1 FADER to the "U" marking and the MAIN MIX fader one quarter of the way up.
7. Sing like a canary!
8. Plug your keyboard into stereo channel 7–8.
9. Slide that channel's FADER to the "U" marking.
10. Play like a madman **and** sing like a canary! It's your first mix!

Please write your serial number here for future reference (i.e. insurance claims, tech support, return authorization, etc.):

Purchased at:

Date of purchase:

INTRODUCTION

Thank you for choosing a Mackie Designs professional compact mixer. The 1402-VLZ PRO is equipped with our new precision-engineered XDR™ Extended Dynamic Range premium studio-grade mic preamp featuring:

- Full gain range from 0 to 60dB
- +22 dBu line signal handling capability
- 130 dB dynamic range
- Distortion less than 0.005%, 20Hz to 20kHz
- Bullet-proof RF rejection using DC pulse transformer circuitry
- Made in Woodinville, Washington, USA

Now that you have your 1402-VLZ PRO, find out how to get the most from it. That's where this manual comes in.

HOW TO USE THIS MANUAL

Since many of you folks will want to hook up your 1402-VLZ PRO immediately, the first pages you will encounter after the table of contents are the everpopular hookup diagrams. These show typical mixer setups for Record/Mixdown, Video, Disc Jockey and Stereo PA. After this section is a detailed tour of the entire mixer.

Every feature of the 1402-VLZ PRO is described “geographically;” in other words, in order of where it is physically placed on the mixer’s top or rear panel. These descriptions are divided into the first three manual chapters, just as your mixer is organized into three distinct zones:

1. PATCHBAY: Along the top and back.
2. CHANNEL STRIP: The ten channel strips on the left.
3. OUTPUT SECTION: The section on the right.

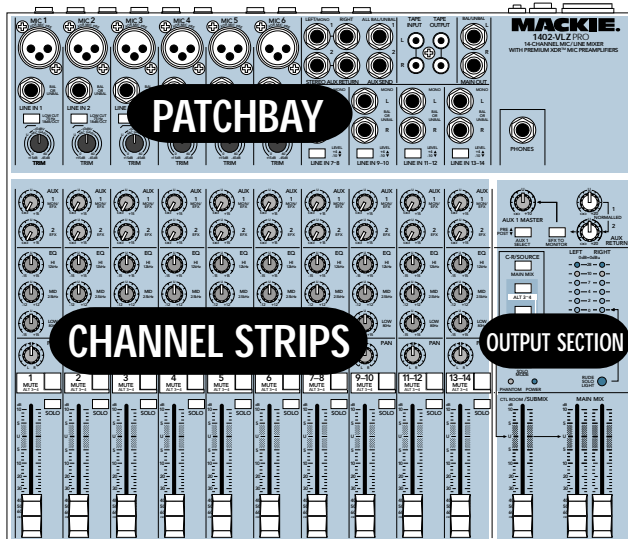

Throughout these chapters you'll find illustrations, with each feature numbered. If you're curious about a feature, simply locate it on the appropriate illustration, notice the number attached to it, and find that number in the nearby paragraphs.

You'll also find cross-references to these numbered features within a paragraph. For instance, if you see “*To wire your own cables:* 5,” simply find that number in the manual and you've found your answer.

Finally, you'll notice feature numbers like this: 26. These numbers direct you to relevant information.



This icon marks information that is critically important or unique to the 1402-VLZ PRO. For your own good, read them and remember them. They will be on the final test. And the final test score will go down on your Permanent Record.



This icon will lead you to in-depth explanations of features and practical tips. While not mandatory, they usually have some valuable nuggets of information.

THE GLOSSARY: A HAVEN OF NON-TECHINESS FOR THE NEOPHYTE

Appendix A is a fairly comprehensive dictionary of pro-audio terms. If terms like “clipping,” “noise floor,” or “unbalanced” leave you blank, flip to this glossary for a quick explanation.

A PLUG FOR THE CONNECTORS SECTION

Appendix B is a section on connectors: XLR connectors, balanced connectors, unbalanced connectors and special hybrid connectors.

ARCANE MYSTERIES ILLUMINATED

Appendix C discusses some of the down 'n' dirty practical realities of microphones, fixed installations, grounding, and balanced versus unbalanced lines. It's a goldmine for the neophyte and even the seasoned pro might learn a thing or two.

CONTENTS

1	LEVEL-SETTING PROCEDURE	3
2	HOOKUP DIAGRAMS	6
3	PATCHBAY DESCRIPTION	10
4	MIC INPUTS	10
5	PHANTOM POWER	10
6	LINE INPUTS	11
7	LOW CUT	11
8A	TRIM	11
8B	+4 / -10	11
9	STEREO LINE INPUTS	12
10	EFFECTS: SERIAL OR PARALLEL?	12
11	INSERT	13
12	AUX RETURNS	13
13	TAPE IN	14
14	XLR MAIN OUTPUTS	14
15	MAIN OUTPUT LEVEL	15
16	1/4" MAIN OUTPUTS	15
17	TAPE OUTPUT	15
18	PHONES	16
19	ALT 3/4	16
20	CONTROL ROOM	16
21	AUX SEND 1 & 2	16
22	POWER CONNECTION	17
23	FUSE	17
24	POWER SWITCH	17
25	PHANTOM SWITCH	17
26	CHANNEL STRIP DESCRIPTION	18
27	"U" LIKE UNITY GAIN	18
28	FADER	18
29	SOLO	18
30	MUTE/ALT 3-4	18
31	PAN	19
32	CONSTANT LOUDNESS !!!	19
33	3-BAND EQ	19
34	AUX SEND	20
35	OUTPUT SECTION DESCRIPTION	21
36	MAIN MIX	21
37	VLZ ² MIX ARCHITECTURE	21
38	SOURCE MATRIX	21
39	CONTROL ROOM / SUBMIX	22
40	SOLO MODE: AFL / PFL	22
41	RUDE SOLO LED	22
42	ASSIGN TO MAIN MIX	23
43	METERS	23
44	AUX TALK	24
45	AUX 1 SELECT	24
46	AUX 1 MASTER	24
47	AUX RETURNS	24
48	EFX TO MONITOR	25
49	JACK NORMALLING	25
50	MODIFICATIONS	26
51	1402-VLZ PRO BLOCK DIAGRAM	30
52	GAIN STRUCTURE DIAGRAM	32
53	SPECIFICATIONS	33
54	SERVICE INFO	34
A	APPENDIX A: Glossary	35
B	APPENDIX B: Connections	44
C	APPENDIX C: Balanced Lines, Phantom Powering, Grounding and Other Arcane Mysteries	47

2 HOOKUP DIAGRAMS

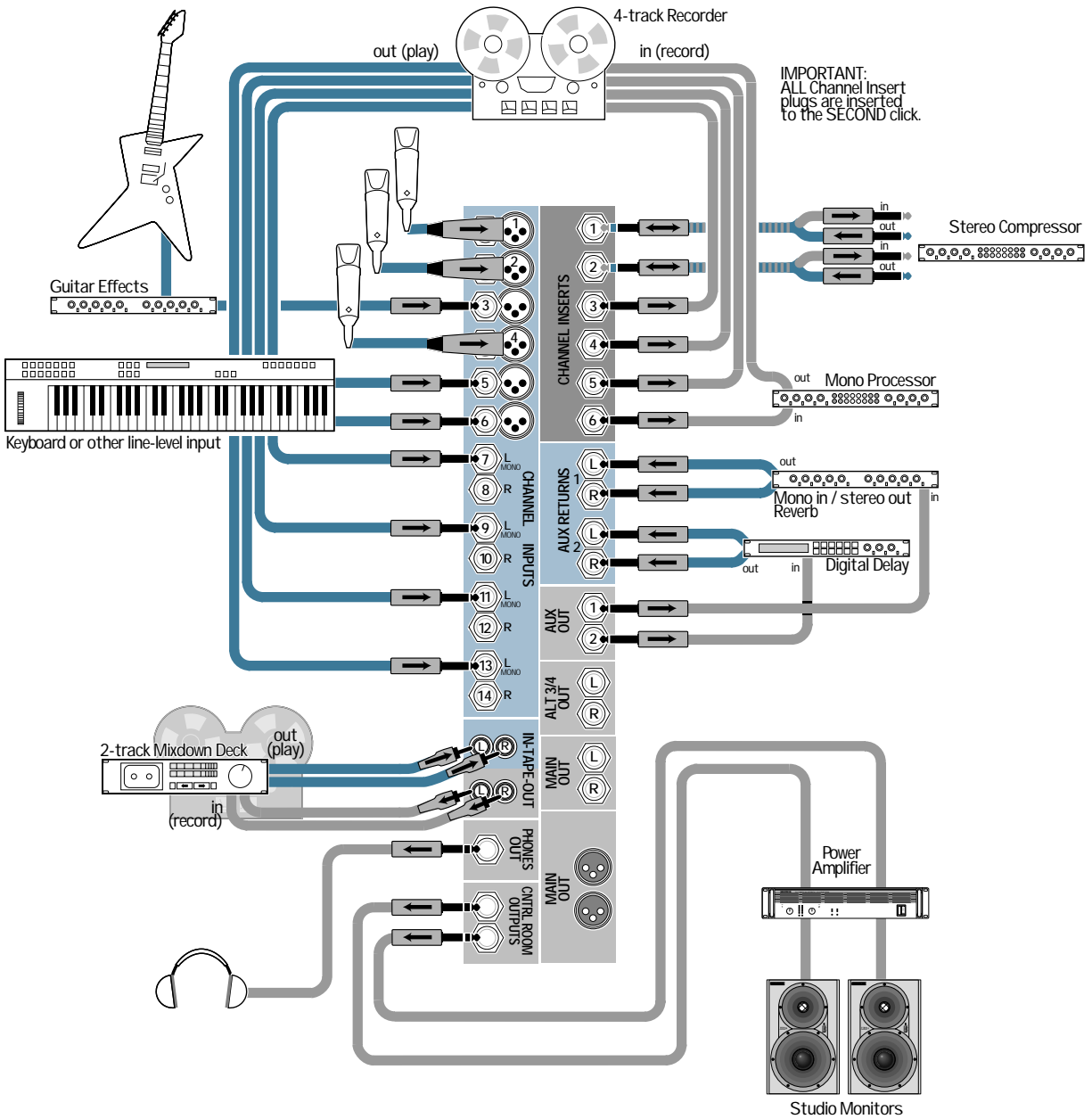

1402-VLZ PRO 4-Track Record / 2-Track Mix

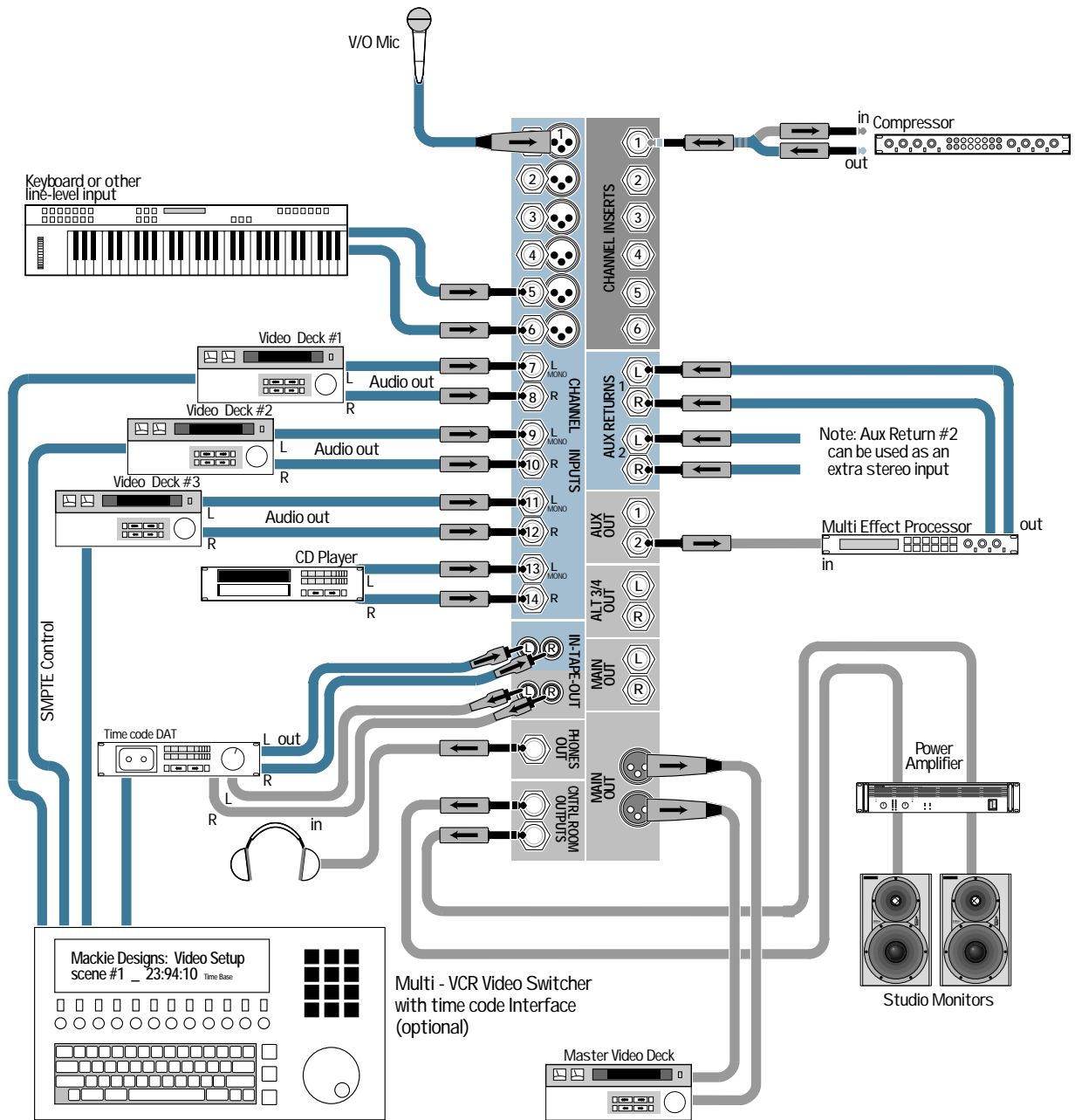

1402-VLZ PRO Video Setup

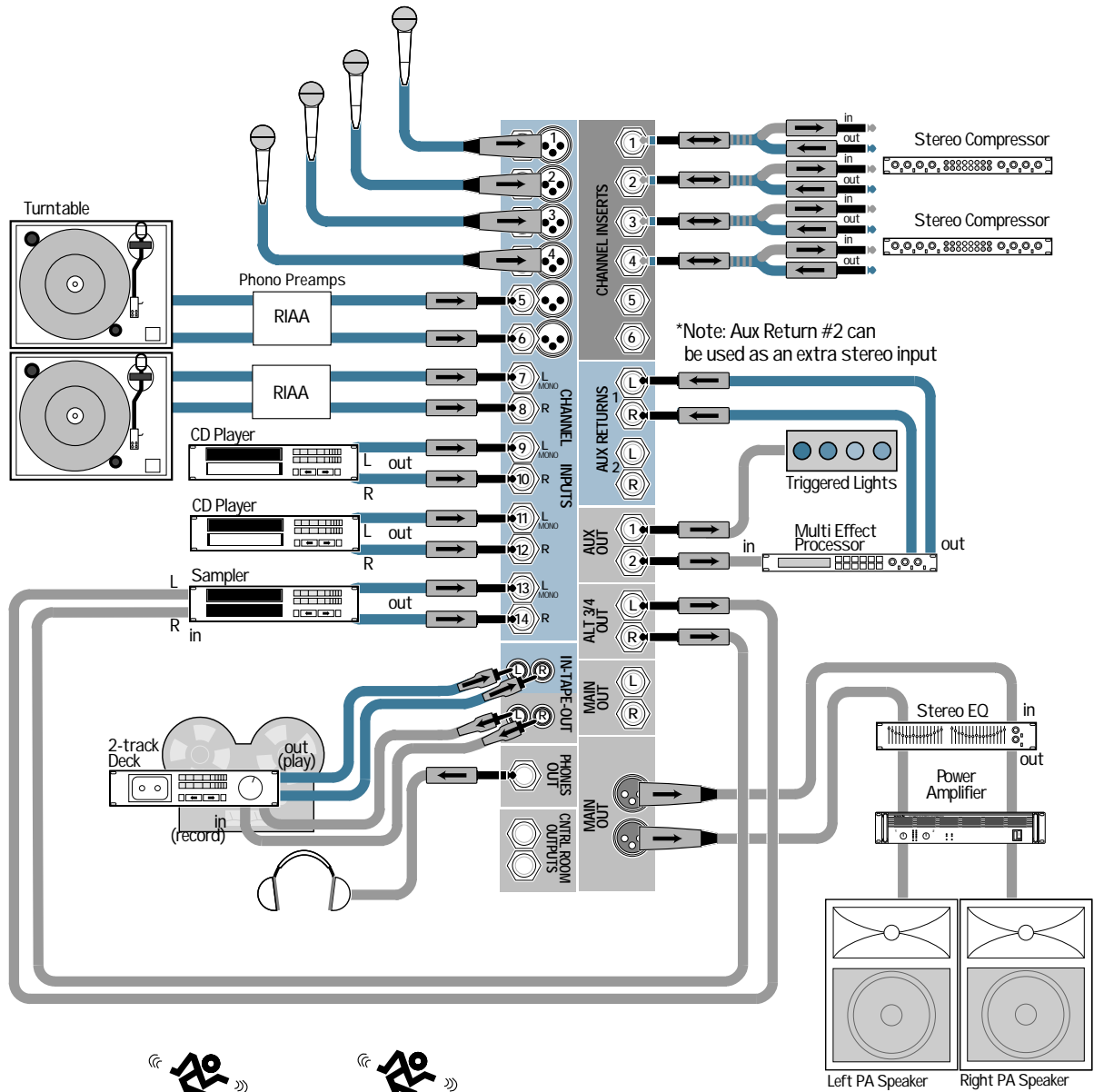

1402-VLZ PRO Disc Jockey Setup

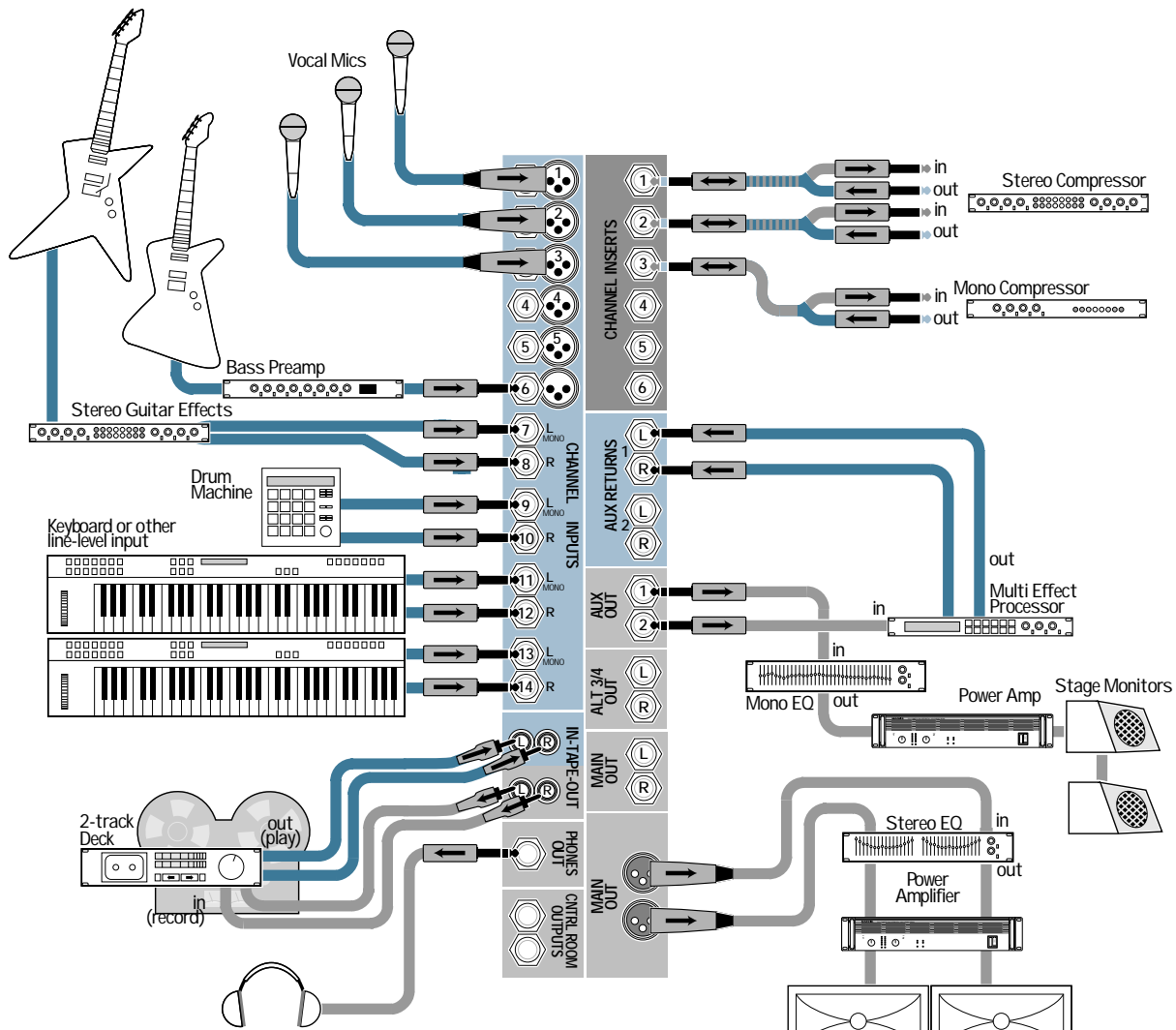

This setup can be easily reconfigured to become a Mono PA setup.

- Stereo sources should feed the left mono side of channel input only.
- Pan each channel hard left.
- Connect Mono PA system to Left main output.

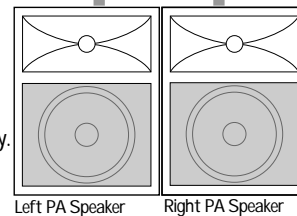

1402-VLZ PRO Stereo PA

3 1402-VLZ PRO PATCHBAY DESCRIPTION

At the risk of stating the obvious, this is where you plug everything in: microphones, line-level instruments and effects, headphones, and the ultimate destination for your sound: a tape recorder, PA system, etc.

4 MIC INPUTS (Channels 1–6)

We use phantom-powered, balanced microphone inputs just like the big studio mega-consoles, for exactly the same reason: This kind of circuit is excellent at rejecting hum and noise. You can plug in almost any kind of mic that has a standard XLR-type male mic connector. *To learn how signals are routed from these inputs:* 26. If you wire your own, connect them like this:

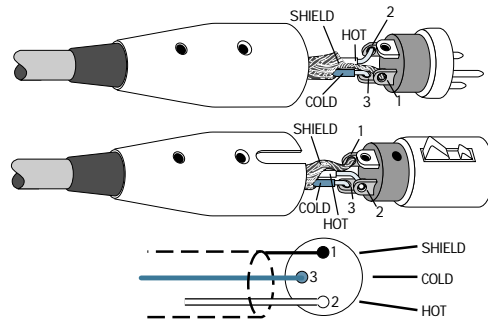

- Pin 1 = Ground or shield
- Pin 2 = Positive (+ or hot)
- Pin 3 = Negative (- or cold)

Professional ribbon, dynamic and condenser mics will all sound excellent through these inputs. The 1402-VLZ PRO's mic inputs will handle any kind of mic level you can toss at them, without overloading. Be sure to perform the **Level Setting Procedure:** 1.

5 PHANTOM POWER

Most modern professional condenser mics are equipped for Phantom Power, which lets the mixer send low-current DC voltage to the mic's electronics through the same wires that carry audio. (Semi-pro condenser mics often have batteries to accomplish the same thing.) "Phantom" owes its name to an ability to be "unseen" by dynamic mics (Shure SM57/SM58, for instance), which don't need external power and aren't affected by it anyway.

The 1402-VLZ PRO's phantom power is globally controlled by the PHANTOM switch on the rear panel 25.



Never plug single-ended (unbalanced) microphones or instruments into the MIC IN jacks if the PHANTOM power is on.

Do not plug instrument outputs into the MIC IN jacks with PHANTOM power on unless you know for certain it is safe to do so.

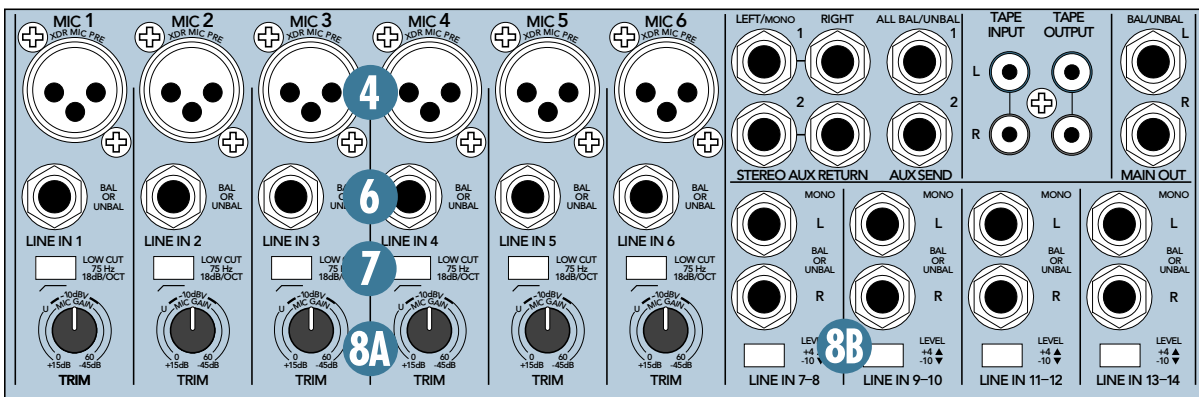

6 LINE INPUTS (Channels 1–6)

These six line inputs share circuitry (but not phantom power) with the mic preamps, and can be driven by balanced or unbalanced sources at almost any level. You can use these inputs for virtually any signal you'll come across, from instrument levels as low as -40dB to operating levels of -10dBV to $+4\text{dBu}$, since there is 40dB more gain available than on Channels 7–14. **To learn how signals are routed from these inputs:** 26.

To connect balanced lines to these inputs, use a $\frac{1}{4}$ " Tip-Ring-Sleeve (TRS) plug, the type found on stereo headphones:

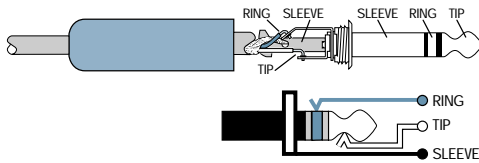

Tip = Positive (+ or hot)
Ring = Negative (– or cold)
Sleeve = Shield or ground

To connect unbalanced lines to these inputs, use a $\frac{1}{4}$ " mono (TS) phone plug or standard instrument cable:

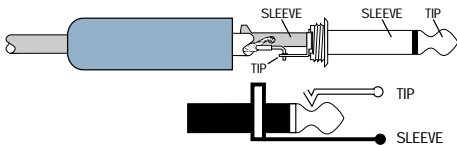

Tip = Signal
Sleeve = Ground

Line inputs 1–6 are a good place to connect older instruments that need more gain. You can correct weak levels by adjusting the corresponding channel's TRIM control 8A.

7 LOW CUT (Channels 1–6)

The LOW CUT switch, often referred to as a High Pass Filter (all depends on how you look at it), cuts bass frequencies below 75Hz at a rate of 18dB per octave.

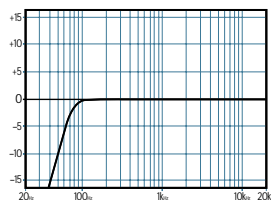

Low Cut

We recommend that you use LOW CUT on every microphone application except kick drum, bass guitar, bassy synth patches, or recordings of

earthquakes. These aside, there isn't much down there that you want to hear, and filtering

it out makes the low stuff you *do* want much more crisp and tasty. Not only that, but LOW CUT can help reduce the possibility of feedback in live situations and it helps to conserve the amplifier power.

Another way to consider LOW CUT's function is that it actually *adds* flexibility during live performances. With the addition of LOW CUT, you can safely use LOW equalization on vocals 33. Many times, bass shelving EQ can really benefit voices. Trouble is, adding LOW EQ also boosts stage rumble, mic handling clunks and breath pops. LOW CUT removes all those problems so you can add low EQ without losing a woofer.

Here's what the combination of LOW EQ 33 and LOW CUT looks like in terms of frequency curves.

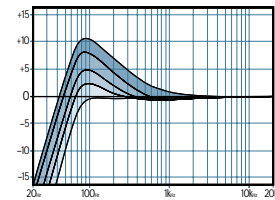

Low Cut with Low EQ

8A TRIM (Channels 1–6)

If you haven't already, please read the **Level Setting Procedure 1**.

TRIM adjusts the input sensitivity of the mic and line inputs connected to Channels 1 through 6. This allows signals from the outside world to be adjusted to optimal internal operating levels.

If the signal originates through the XLR jack, there will be 0dB of gain with the knob fully down, ramping to 60dB of gain fully up.

Through the $\frac{1}{4}$ " input, there is 15dB of attenuation fully down and 45dB of gain fully up, with a "U" (unity gain) mark at 10:00.

This 15dB of attenuation can be very handy when you are inserting a signal that is very hot, or when you want to add a lot of EQ gain, or both. Without this "virtual pad," a scenario like that might lead to channel clipping.

8B +4 / -10 (Channels 7–14)

This switch adjusts the input sensitivity of the line inputs on channels 7–14. If the sound source is a -10 device, engage this switch. If you are unsure, leave the switch up and perform the **Level Setting Procedure 1**, substituting this switch for the TRIM knob and then setting the switch to the appropriate gain setting.

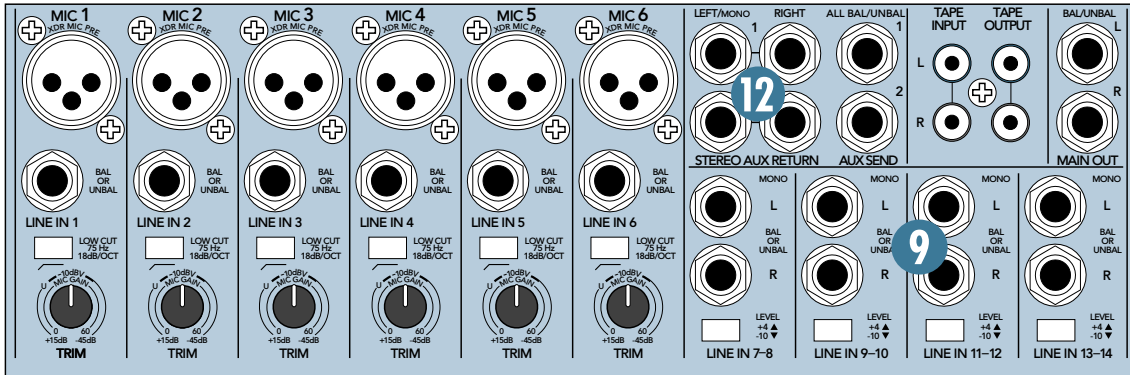

9 STEREO LINE INPUTS (Channels 7–8, 9–10, 11–12 and 13–14)

These fully balanced inputs are designed for stereo or mono, balanced or unbalanced signals, from -10dBV to $+4\text{dBu}$. They can be used with just about any professional or semi-pro instrument, effect or tape player. *To learn how signals are routed from these inputs:* 26. *To wire your own cables:* 6.

In the stereo audio world, an odd-numbered channel usually receives the “left signal.” For example, you would feed the 1402-VLZ PRO’s line inputs 7–8 a stereo signal by inserting the device’s left output plug into the Channel 7 jack, and its right output plug into the Channel 8 jack.

When connecting a mono device (just one cord), always use the Left (MONO) input and plug nothing into the Right input — this way the signal will appear on both sides. This trick is called “jack normalling” 49.



10 EFFECTS: SERIAL OR PARALLEL?

The next two sections toss the terms “serial” and “parallel” around like hacky sacks.

Here’s what we mean by them.

“Serial” means that the *entire* signal is routed through the effects device. Examples: compressor/limiters, graphic equalizers. Line-level sources can be patched through a serial effects device before or after the mixer or, more conveniently, through the channel insert jacks located on the rear of the mixer (INSERT SEND/RETURN) 11.

“Parallel” means that a *portion* of the signal in the mixer is tapped off to the device (AUX SEND), processed and returned to the mixer (AUX RETURN) to be mixed with the original “dry” signal. This way, multiple channels can all make use of the same effects device. Examples: reverb, digital delay. (See diagrams below.)

10

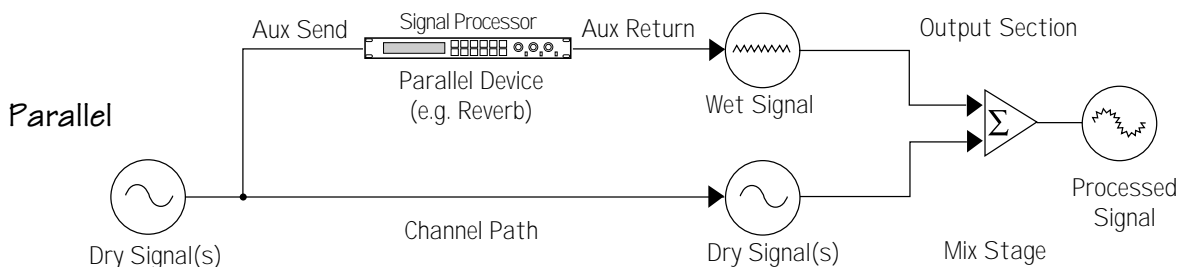
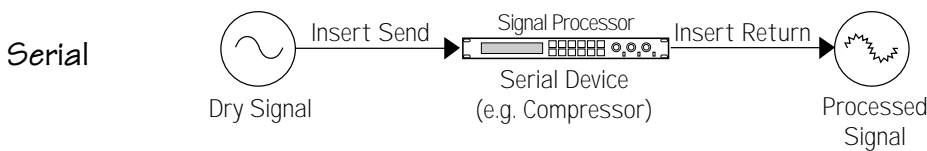

11 INSERT (Channels 1–6)

These jacks, on the back of the 1402-VLZ PRO, are where you connect serial effects such as compressors, equalizers, de-essers, or filters [10](#). Since most people don't have more than a few of these gadgets, we've included inserts for just the first six channels. If you want to use this kind of processing on Channels 7–14, simply patch through the processor before you plug into the 1402-VLZ PRO.

The INSERT points are after the TRIM and LOW CUT controls, but before the channel's EQ and FADER controls. The *send* (tip) is low-impedance (120 ohms), capable of driving any device. The *return* (ring) is high-impedance (over 2.5k ohms) and can be driven by almost any device.

INSERT cables must be wired thusly:

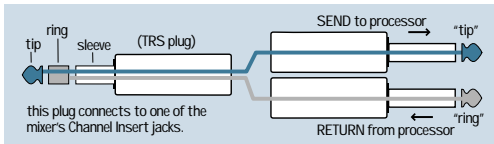

Tip = Send (output to effects device)
Ring = Return (input from effects device)
Sleeve = Common ground (connect shield to all three sleeves)

Besides being used for inserting external devices, these jacks can also be used as channel *direct outputs*, post-TRIM, post-LOW CUT, and pre EQ. Check out the 4-track hookup diagram [2](#). Here's three ways you can use the INSERT jacks:

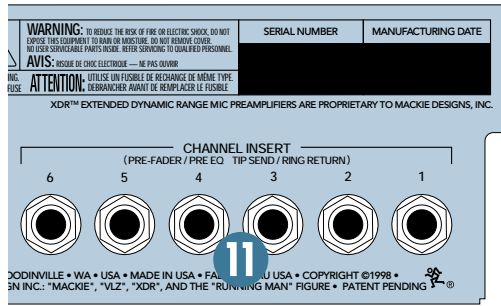
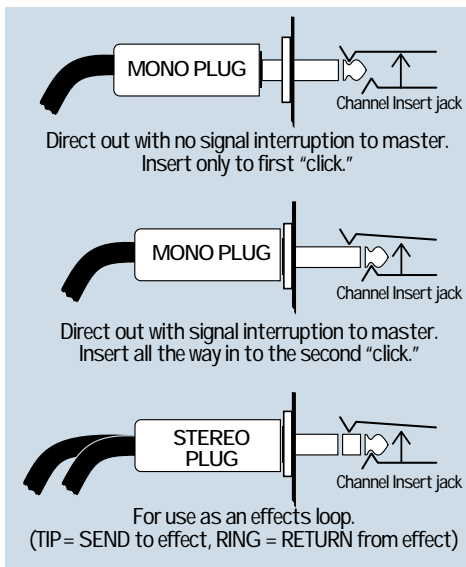

12 AUX RETURNS

This is where you connect the outputs of your parallel effects devices (or extra audio sources). These balanced inputs are similar to the stereo line inputs [9](#) without EQ, Aux Sends, Pan, Mute, and Solo. The circuits will handle stereo or mono, balanced or unbalanced signals, either instrument level, -10dBV or $+4\text{dBu}$. They can be used with just about any pro or semi-pro effects device on the market. *To learn how signals are routed from these inputs, see [47](#).*



One Device: If you have just one parallel effects device, use AUX RETURN 1 and leave AUX RETURN 2 unplugged.

That way, the unused AUX RETURN 2 LEVEL control can be used to feed AUX RETURN 1 to your stage monitors, via the EFX TO MONITOR switch [48](#).

Mono Device: If you have an effects device with a mono output (1 cord), plug that into AUX RETURN 1 LEFT and leave AUX RETURN 1 RIGHT unplugged. That way the signal will be sent to both sides, magically appearing in the center as a mono signal. This won't work with AUX RETURN 2 — you'll need a Y-cord to feed the L/R bus. In short, AUX RETURN 1 uses jack normalling. AUX RETURN 2 does not use jack normalling.

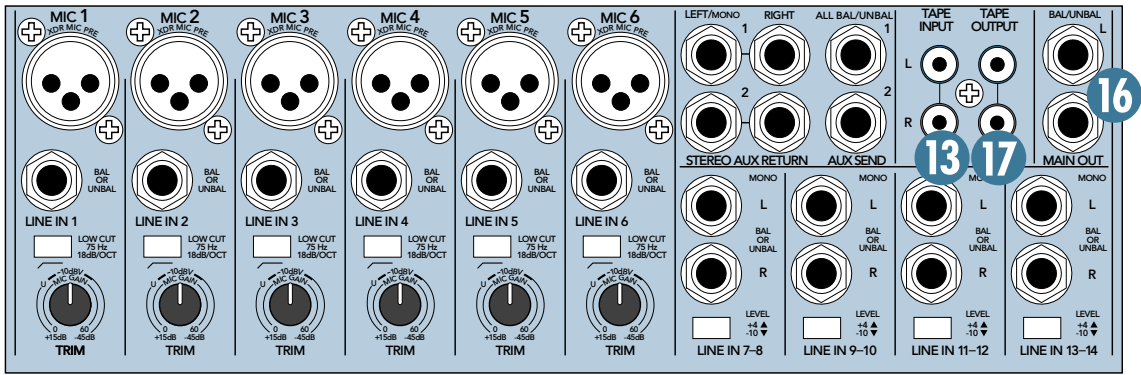

13 TAPE IN

These RCA jacks are designed to work with semi-pro as well as pro recorders. To compensate for typically low levels, signals coming in here will be automatically boosted by 6dB.

Connect your tape recorder's outputs here, using standard hi-fi (RCA) cables. *To learn how signals are routed from these inputs, see 33.*

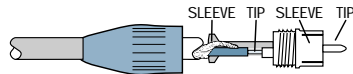

Use these jacks for convenient tape playback of your mixes. You'll be able to review a mix, and then rewind and try another pass, without repatching or disturbing the mixer levels. You can also use these jacks with a portable tape or CD player to feed music to a PA system between sets.



WARNING: Pushing TAPE in the SOURCE matrix and ASSIGN TO MAIN MIX can create a feedback path between

TAPE IN and TAPE OUT. Make sure your tape deck is not in record, record-pause or input monitor mode when you engage these switches, or make sure the CTL ROOM / SUBMIX fader is fully down (off).

Outputs? The 1402-VLZ PRO has plenty of 'em: XLR MAIN, 1/4" MAIN, TAPE, PHONES, CONTROL ROOM and AUX SENDS. Let's take a peek.

14 XLR MAIN OUTPUTS

These low-impedance outputs are fully balanced and capable of driving +4dBu lines with up to 28dB of headroom. This output is 6dB hotter than other outputs. *To learn how signals are routed to these outputs: 36.*

To use these outputs, wire the XLR (balanced only) connectors like this:

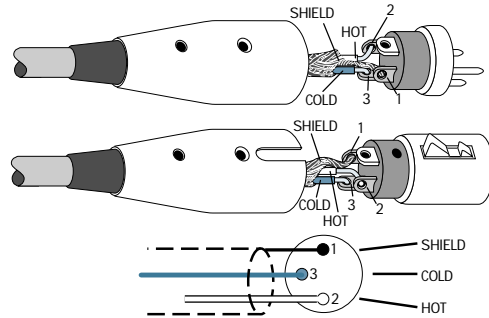

- Pin 1 = Ground
- Pin 2 = Positive (+ or hot)
- Pin 3 = Negative (- or cold)

15 MAIN OUTPUT LEVEL

Engaging this switch pads the balanced XLR MAIN OUTPUTS by 30dB, so you can feed the microphone input of, say, another mixer. Perfect for sending a submix to another mic level input in boardroom or conference room applications.

You can safely plug this output into an input that provides 48V phantom power.

16 1/4" MAIN OUTPUTS

These 1/4" jacks are balanced outputs capable of delivering 22dBu into a 600 ohm balanced or unbalanced load. (Okay, we admit it, that was a pretty technical sentence. See the **Glossary** and **Connections** appendices if you want to decode it.)

To learn how signals are routed to these 1/4" outputs: 36.

To use these outputs to drive balanced inputs, connect 1/4" TRS (Tip-Ring-Sleeve) phone plugs like this:

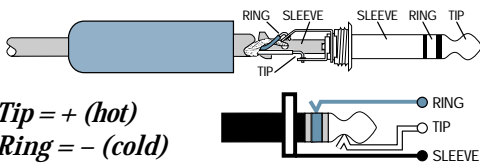

For most music recording and PA applications, unbalanced lines are perfectly acceptable. To use these outputs to drive unbalanced inputs, connect 1/4" TS (Tip-Sleeve) phone plugs like this:

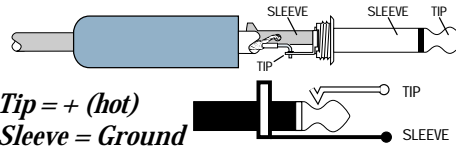

17 TAPE OUTPUT

These unbalanced RCA connections tap the MAIN OUTPUTS to make simultaneous recording and PA work more convenient. Connect these to your recorder's inputs. *To learn how signals are routed to these outputs: 36.*

MONO OUT: If you want to feed a mono signal to your tape deck or other device, simply use an RCA Y-cord to combine these outputs (Radio Shack® #274-511, for instance). *Do not attempt this with any other outputs on the 1402-VLZPRO.*

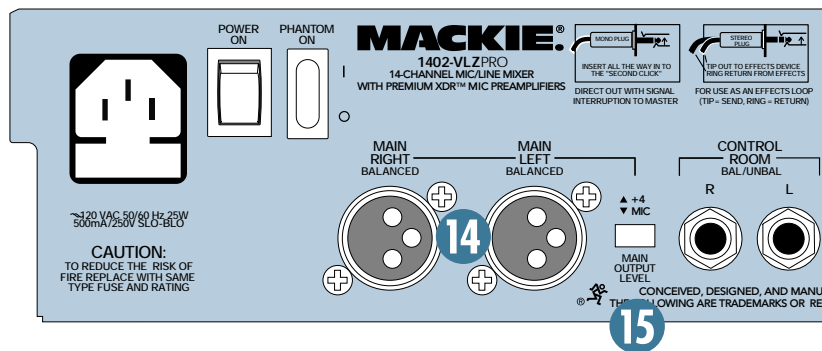
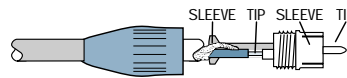

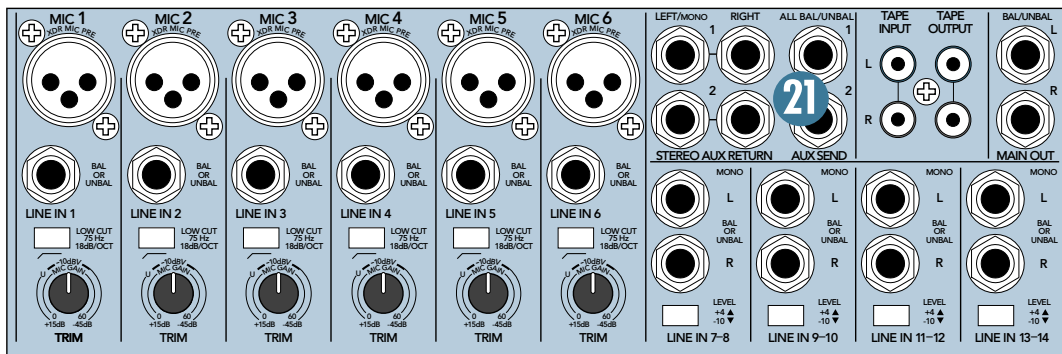

18 PHONES

The 1402-VLZ.PRO's stereo PHONES jack will drive any standard headphone to very loud levels. Walkperson-type phones can also be used with an appropriate adapter. *To learn how signals are routed to these outputs:* 33. If you're wiring your own cable for the PHONES output, follow standard conventions:

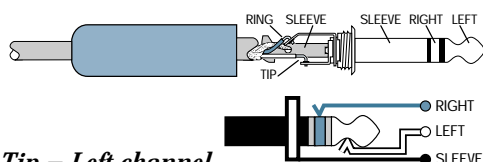

Tip = Left channel

Ring = Right channel

Sleeve = Common ground



WARNING: When we say the headphone amp is loud, we're not kidding. It can cause permanent ear damage. Even intermediate levels may be painfully loud with some earphones. BE CAREFUL!

Always turn the CTL ROOM/SUBMIX fader all the way down before connecting headphones. Keep it down until you've put the phones on. Then turn it up slowly. Why? *"Engineers who fry their ears find themselves with short careers."*

19 ALT 3/4

These 1/4" jacks are balanced outputs capable of delivering 22dBu into a balanced or unbalanced load. *To learn how signals are routed to these outputs:* 30. *To wire your own cables:* 16.

20 CONTROL ROOM

These 1/4" jacks are balanced outputs capable of delivering 22dBu into a 600 ohm balanced or unbalanced load. *To learn how signals are routed to these outputs:* 33. *To wire your own cables:* 16.

21 AUX SEND 1&2

These 1/4" jacks are also balanced outputs capable of delivering 22dBu into a 600 ohm balanced or unbalanced load. *To learn how signals are routed to these outputs:* 34. *To wire your own cables:* 16.

22 POWER CONNECTION

Just in case you lose the cord provided with the 1402-VLZ PRO, its power jack accepts a standard 3-prong IEC cord like those found on most professional recorders, musical instruments, and computers.

At the other end of our cord is — get this — a plug! Not a black cube or, as we're fond of calling them, a "wall wart." We did this for some very good reasons:

The 1402-VLZ PRO has sophisticated power requirements that a wall wart cannot provide. Wall warts are inconvenient, fragile, radiate huge hum fields, hog extra jacks on your power strip and get in the way. If you lose a wall wart, you're in trouble, but if you lose the 1402-VLZ PRO's power cord, you can get a new one at any electronics, music, or computer store. You can even buy them at Radio Shack® (part # 287-1257). Can you tell that we hate wall warts?

Plug the 1402-VLZ PRO into any standard grounded AC outlet or into a power strip of proper voltage.



WARNING: Disconnecting the plug's ground pin can be dangerous. Please don't do it.

23 FUSE

The 1402-VLZ PRO is fused for your (and its own) protection. If you suspect a blown fuse, disconnect the cord, pull the fuse drawer out (located just below the cord receptacle) and replace the fuse with a 500mA (0.5 amps) SLO BLO, 5x20mm, available at electronics stores or your dealer (or a 250mA SLO BLO 5x20mm if your 1402-VLZ PRO is a 220V–240V unit).

If two fuses blow in a row, something is very wrong. Please call our toll-free number (or the distributor in your country) and find out what to do.

24 POWER SWITCH

If this one isn't self-explanatory, we give up. You can leave this switch on all the time; the 1402-VLZ PRO is conservatively designed, so heat buildup isn't a problem even in 24-hour-a-day operation. There's nothing that will burn out or get used up. Or, just plug everything into a good quality power strip for one-button turn-on.



You may notice that the 1402-VLZ PRO feels quite warm in the upper-right corner. This is perfectly normal.

(Perfectly normal. Is that redundant?)

In the output section there is a POWER LED. If the power is on, so is the LED.

25 PHANTOM SWITCH

The Phantom Power Switch controls the phantom power supply for condenser microphones plugged into channels 1-6 mic inputs as discussed at the start of this section 5. When turned on (or off), the phantom power circuitry takes a few moments for voltage to ramp up (or down). This is also perfectly normal. For an even closer look, refer to **Appendix C**.

In the output section, next to the POWER LED, is the PHANTOM LED. If the phantom power is on, so is the LED.

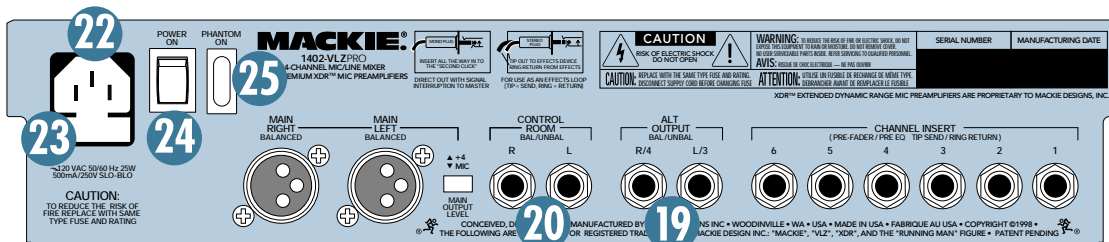

26 CHANNEL STRIP DESCRIPTION

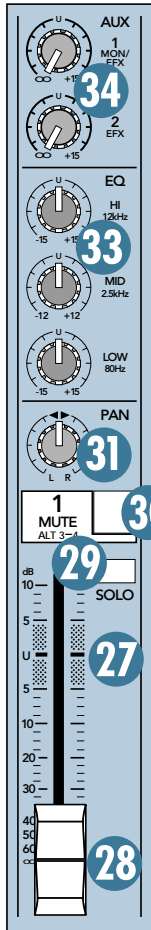

The ten channel strips look alike, and function identically. The only difference is that the six on the left are for individual mics or mono instruments and have more gain available, while the next four are for either stereo or mono line-level sources. (Each of the stereo channel strips is actually two complete circuits. The controls are linked together to preserve stereo.) We'll start at the bottom and work our way up...



27 "U" LIKE UNITY GAIN

Mackie mixers have a "U" symbol on almost every level control. This "U" stands for "unity gain," meaning no change in signal level. Once you have adjusted the input signal to line-level 1, you can set every control at "U" and your signals will travel through the mixer at optimal levels. What's more, all the labels on our level controls are measured in decibels (dB), so you'll know what you're doing level-wise if you choose to change a control's settings.

You won't have to check it here and check it there, as you would with some other mixers. In fact, some don't even have any reference to actual dB levels at all! Ever seen those "0–10" fader markings? We call these AUMs (Arbitrary Units of Measurement), and they mean nothing in the real world. You were smart — you bought a Mackie.

28 FADER

The FADER controls the channel's level... from off to unity gain at the "U" marking, on up to 10dB of additional gain. Channels 1–6 use mono controls, and channels 7–14 use stereo controls.

29 SOLO

This lovable switch allows you to hear signals through your headphones or control room 40 without having to route them to the MAIN or ALT 3–4 mixes. Folks use solo in live work to preview channels before they are let into the mix, or to just check out what a particular channel is up to anytime during a session. You can solo as many channels at a time as you like.

Solo is also the key player in the **Level Setting Procedure 1**.

Your 1402-VLZ PRO has "Dual-Mode Solo." A switch in the master section 40 determines

which mode you'll be hearing. With the switch up, you'll get "AFL" (After Fader Listen), which is post-FADER and post-PAN, making it ideal for mixdown soloing. With the switch down, you're in "PFL" (pre-fader listen) mode. This is the required mode for the **Level Setting Procedure 1**.

Soloed channels are sent to the SOURCE mix 38, which ultimately feeds your CONTROL ROOM, PHONES and METERS. Whenever SOLO is engaged, all SOURCE selections (MAIN MIX, ALT 3–4 and TAPE) are defeated, to allow the soloed signal to do just that — solo!

30 MUTE/ALT 3–4

The dual-purpose MUTE/ALT 3–4 switch is a Mackie signature. When Greg was designing our first product, he had to include a mute switch for each channel. Mute switches do just what they sound like they do. They turn off the signal by "routing" it into oblivion. *"Gee, what a waste,"* Greg reasoned. *"Why not have the mute button route the signal somewhere else useful... like a separate stereo bus?"* So MUTE/ALT 3–4 really serves two functions — muting (often used during a mixdown or live show), and signal routing (for multi-track and live work) where it acts as an extra stereo bus.

To use this as a MUTE switch, all you have to do is *not* use the ALT 3–4 outputs. Then, whenever you assign a channel to these unused outputs, you'll also be disconnecting it from the MAIN MIX, effectively muting the channel.

To use this as an ALT 3–4 switch, all you have to do is connect the ALT 3–4 outputs to whatever destination you desire. Two popular examples:

When doing multitrack recording, use the ALT 3–4 outputs to feed your multitrack. With most decks, you can mult the ALT 3–4 outputs, using Y-cords or mults, to feed multiple tracks. So, take ALT OUT LEFT and send it to tracks 1, 3, 5 and 7, and ALT OUT RIGHT and send it to tracks 2, 4, 6 and 8. Now, tracks that are in Record or Input modes will hear the ALT 3–4 signals, and tracks in Playback or Safe modes will ignore them.

When doing live sound or mixdown, it's often handy to control the level of several channels with one knob. That's called Subgrouping. Simply assign these channels to the ALT 3–4 mix, engage ALT 3–4 in the SOURCE matrix, and the signals will appear at the CONTROL ROOM

and PHONES outputs. If you want the ALT 3-4 signals to go back into the MAIN MIX, engage the ASSIGN TO MAIN MIX switch 42, and the CTL ROOM/SUBMIX fader becomes the one fader to control the levels of all channels assigned to ALT 3-4.

Another way to do the same thing is to assign the channels to the ALT 3-4 mix, then patch out of the ALT OUT LEFT and RIGHT back into an unused stereo channel (7-8, 9-10 or 11-12 or 13-14). If that's your choice, don't ever engage the MUTE/ALT 3-4 switch on that stereo channel, or you'll have every dog in the neighborhood howling at your feedback loop.

Another benefit of the ALT 3-4 feature is that it can act as a "AFL" (After Fader Listen): just engage a channel's MUTE/ALT 3-4 switch and the ALT 3-4 switch in the SOURCE matrix 38 and you'll get that channel, all by itself, in the CONTROL ROOM and PHONES.

MUTE/ALT 3-4 is one of those controls that can bewilder newcomers, so take your time and play around with it. Once you've got it down, you'll probably think of a hundred uses for it!

31 PAN

PAN adjusts the amount of channel signal sent to the left versus the right outputs. On mono channels (ch. 1-6 or 7-14 with connections to the LEFT input only) these controls act as pan pots. On stereo channels (7-14) with stereo connections to LEFT and RIGHT inputs, the pan knob works like the balance control on your home stereo.

PAN determines the fate of the MAIN MIX (1-2) and ALT 3-4 mix. With the PAN knob hard left, the signal will feed either MAIN LEFT (bus 1) or ALT LEFT (bus 3), depending on the position of the ALT 3-4 switch. With the knob hard right, the signal feeds MAIN RIGHT (bus 2) or ALT RIGHT (bus 4). You'll soon discover that maybe we should've called this an 1404-VLZ², since it really is a 4-bus mixer.



32 CONSTANT LOUDNESS !!!

The 1402-VLZ PRO's PAN controls employ a design called "Constant Loudness."

It has nothing to do with living next to a freeway. As you turn the PAN knob from left to right (thereby causing the sound to move from the left to the center to the right), the sound will appear to remain at the same volume (or loudness).

If you have a channel panned hard left (or right) and reading 0dB, it must dip down about 4dB on the left (or right) when panned

center. To do otherwise (the way Brand X compact mixers do) would make the sound appear much louder when panned center.



33 3-BAND EQ

The 1402-VLZ PRO has 3-band equalization at carefully selected points — LOW shelving at 80Hz,

MID peaking at 2.5kHz, and HI shelving at 12kHz. "Shelving" means that the circuitry boosts or cuts all frequencies past the specified frequency. For example, rotating the 1402-VLZ PRO's LOW EQ knob 15dB to the right boosts bass starting at 80Hz and continuing down to the lowest note you never heard. "Peaking" means that certain frequencies form a "hill" around the center frequency — 2.5kHz in the case of the MID EQ.

LOW EQ

This control gives you up to 15dB boost or cut at 80Hz. The circuit is flat (no boost or cut) at the center detent position. This frequency represents the punch in bass drums, bass guitar, fat synth patches, and some really serious male singers.

Used in conjunction with the LOW CUT switch 7, you can boost the LOW EQ without injecting a ton of subsonic debris into the mix.

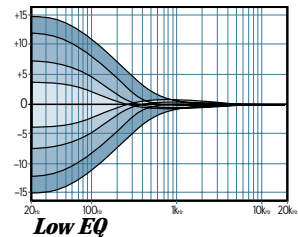

Low EQ

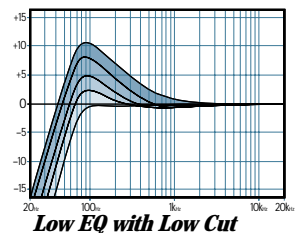

Low EQ with Low Cut

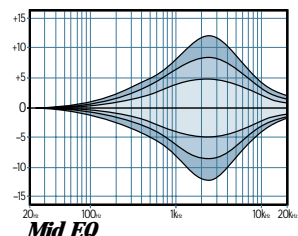

Mid EQ

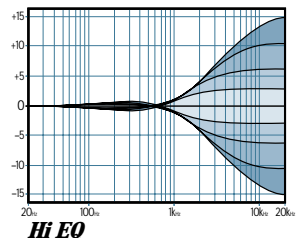

Hi EQ

MID EQ

Short for "midrange," this knob provides 12dB of boost or cut, centered at 2.5kHz, also flat at the center detent. Midrange EQ is often thought of as the most dynamic, because the frequencies that define any particular sound are almost always found in this range. You can create many interesting and useful EQ changes by turning this knob down as well as up.

HI EQ

This control gives you up to 15dB boost or cut at 12kHz, and it is also flat at the detent. Use it to add sizzle to cymbals, and an overall sense of transparency or edge to keyboards, vocals, guitar and bacon frying. Turn it down a little to reduce sibilance, or to hide tape hiss.

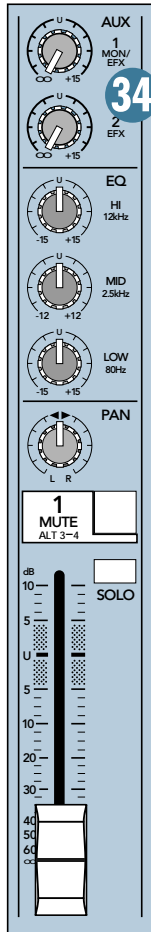

Moderation during EQ

With EQ, you can also screw things up royally. We've designed a lot of boost and cut into each equalizer circuit, because we know everyone will occasionally need that. But if you max the EQs on every channel, you'll get mix mush. Equalize subtly and use the left sides of the knobs (cut), as well as the right (boost). Very few gold-record-album engineers ever use more than about 3dB of EQ. If you need more than that, there's usually a better way to get it, such as placing a mic differently (or using a different kind of mic entirely).

34 AUX SEND

These tap a portion of each channel signal out to another source for parallel effects processing or stage monitoring. AUX send levels are controlled by the channel's AUX 1 and AUX 2 knobs 34 and by the AUX 1 MASTER 46.

These are more than just effects and monitor sends. They can be used to generate separate mixes for recording or "mix-minuses" for broadcast. By using AUX 1 in the PRE mode 45, these mix levels can be obtained independently of the channel's GAIN control.

AUX 1 in POST-mode 45 and AUX 2 are post-LOW CUT, post-EQ and post-FADER. That is, the sends obey the settings of these controls. AUX 1 in PRE mode follows the EQ and LOW CUT settings only. PAN and FADER have no effect on the PRE send (see diagram below).

All AUX send levels range from *off* through *unity* (with their channel gain controls at the center detent position) on up to 15dB of extra gain (when turned fully clockwise). Chances are you'll never need this extra gain, but it's nice to know it's there if you do.

Channel 7–14 AUX pots control the mono sum of the channel's stereo signals for each AUX send. For instance, Channel 7 (left) and 8 (right) mix together to feed that channel's AUX send knobs.

We recommend going into a stereo reverb in mono and returning in stereo. We have found that most "stereo" reverbs' second input just ties up an extra AUX send and adds nothing to the sound. There are exceptions, so feel free to try it both ways. If your effects device is true stereo all the way through, use AUX 1 to feed its LEFT input and AUX 2 to feed the RIGHT input.

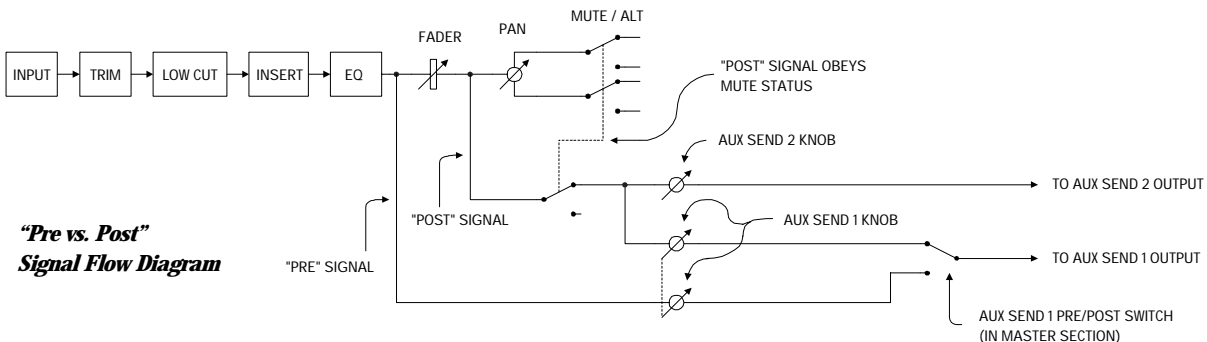

35 OUTPUT SECTION DESCRIPTION

Still with us? Good for you. Here come the tricky parts, where the mixing is really done.

36 MAIN MIX

As the name implies, this fader controls the levels of signals sent to the MAIN OUTPUTS: XLR 14, 1/4" 16 and RCA TAPE OUT 17. All channels and AUX RETURNS that are not muted or turned fully down will wind up in the MAIN MIX.

Fully down is off, the "U" marking is unity gain, and fully up provides 10dB additional gain. This additional gain will typically never be needed, but once again, it's nice to know it's there. These are the faders to pull down at the end of the song when you want The Great Fade-Out.



37 VLZ MIX ARCHITECTURE

When designing a mixing circuit, the lowest noise and best crosstalk specs are achieved by using Very Low Impedance (VLZ). To implement VLZ in a mixer, the power supply must be able to deliver plenty of current to the circuitry. That's why those "wall wart" mixers are often noisy – they can't power a VLZ circuit.

At Mackie, audio quality is much more important than the price of wall warts. All of our mixers employ VLZ and built-in power supplies that deliver more than enough current, resulting in sonic specifications that rival consoles upwards of \$50,000!

38 SOURCE MATRIX

Typically, the engineer sends the MAIN MIX to an audience (if live) or a mixdown deck (if recording). But what if the engineer needs to hear something other than the MAIN MIX? With the 1402-VLZ PRO, the engineer has several choices of what to listen to. This is one of those tricky parts, so buckle up.

Via the SOURCE switches, you can choose to listen to any combination of MAIN MIX, ALT 3-4 and TAPE. By now, you probably know what the MAIN MIX is. ALT 3-4 is that additional stereo mix bus. TAPE is the stereo signal coming in from the TAPE IN RCA jacks 13.

Selections made in the SOURCE matrix deliver stereo signals to the CONTROL ROOM, PHONES and METERS. With no switches engaged, there will be no signal at these outputs and no meter indication.

The exception to that is the SOLO function 29. Regardless of the SOURCE matrix selection, engaging a channel's SOLO switch will replace that selection with the SOLO signal, also sent to the CONTROL ROOM, PHONES and METERS. This is what makes the **Level Setting Procedure 1** so easy to do.



WARNING: Pushing in both the TAPE button (in the SOURCE matrix) and ASSIGN TO MAIN MIX can create a feedback path between TAPE IN and TAPE OUT. Make sure your tape deck is not in record, record-pause or input monitor mode when you engage these switches, or make sure the CONTROL ROOM / PHONES fader is fully down (off).

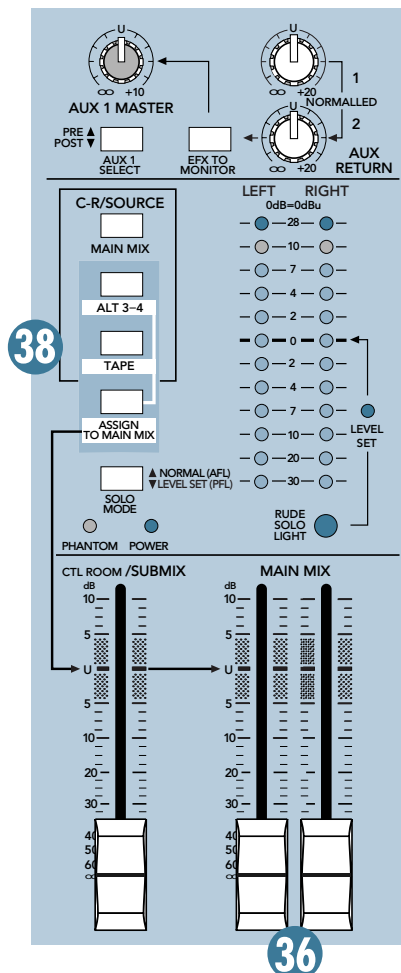

Now you know how to select the signals you want to send to the engineer's control room or phones. From there, these signals all pass through the same level control:

39 CTL ROOM / SUBMIX

This fader controls the levels of both the stereo CONTROL ROOM OUTPUTS 20 and PHONES OUTPUTS 18. The control range is from *off* through *unity* gain at the "U" marking, with 10dB of extra gain fully up.

When MAIN MIX is your SOURCE selection, those signals will pass through two level controls on the way to your control room amp and phones — the MAIN MIX fader and this CTL ROOM / SUBMIX fader. This way, you can send a nice healthy level to the MAIN OUTPUTS (MAIN MIX fader at "U"), and a quiet level to the control room or phones (CTL ROOM / SUBMIX fader wherever you like it).

When ALT 3-4 or TAPE is selected, or SOLO is engaged, this fader will be the only one controlling these levels (channel controls notwithstanding).

Whatever your selection, you can also use the CONTROL ROOM OUTPUTS for other applications. It's sound quality is just as impeccable as the MAIN MIX outputs. It can be used as additional MAIN MIX output, which may sound silly since there are already three, but this one has its own level control. However, should you do something like this, be sure that you never engage a SOLO switch, as that will interrupt your SOURCE selection.

40 SOLO MODE: AFL/PFL

Engaging a channel's SOLO switch 29 will cause this dramatic turn of events: Any existing SOURCE matrix selections will be replaced by the SOLO signal, appearing at the CONTROL ROOM OUTPUTS, PHONES OUTPUTS and at the METERS. The audible SOLO levels are then controlled by the CTL ROOM / SUBMIX fader. The SOLO levels appearing on the METERS 43 are not controlled by anything — you wouldn't want that. You want to see the actual channel level on the METERS regardless of how loud you're listening.

With the SOLO MODE switch in the up position, you're in AFL mode, meaning After-Fader Listen. You'll hear the output of the soloed channel — it will follow the channel's TRIM, EQ, FADER and PAN settings. It's similar to muting all the other channels, but without the hassle. Use AFL mode during mixdown.

With the switch down, you're in PFL mode, meaning Pre-Fader Listen (post EQ). This mode is required for the **Level Setting Procedure 1** and is handy for quick spot-checks of channels, especially ones that have their faders turned down.

In either mode, SOLO will not be affected by a channel's MUTE/ALT switch position.

41 RUDE SOLO LIGHT

This flashing Light Emitting Diode serves two purposes — to remind you that at least one channel is in SOLO, and to let you know that you're mixing on a Mackie. No other company is so concerned about your level of SOLO awareness. If you work on a mixer that has a solo function with no indicator lights, and you happen to forget you're in solo, you can easily be tricked into thinking that something is wrong with your mixer. Hence the RUDE SOLO LIGHT. It's especially handy at about 3AM when no sound is coming out of your monitors but your multitrack is playing back like mad.

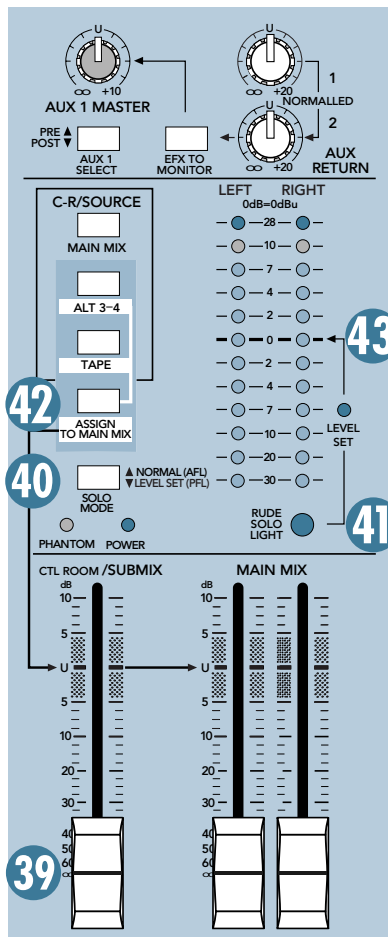

42 ASSIGN TO MAIN MIX

Let's say you're doing a live show. Intermission is nearing and you'll want to play a soothing CD for the crowd to prevent them from becoming antsy. Then you think, "***But I have the CD player plugged into the TAPE inputs, and that never gets to the MAIN OUTPUTS!***" Oh, but it does. Simply engage this switch and your SOURCE matrix selection, after going through the CTL ROOM / SUBMIX fader, will feed into the MAIN MIX, just as if it were another stereo channel.

Another handy use for this switch is to enable the ALT 3-4 mix to become a submix of the MAIN MIX 36, using the CTL ROOM / SUBMIX fader as its level control.

Side effects: (1) Engaging this switch will also feed any soloed channels into the MAIN MIX, which may be the last thing you want. (2) If you have MAIN MIX as your SOURCE matrix selection and then engage ASSIGN TO MAIN MIX, the MAIN MIX lines to the SOURCE matrix will be interrupted, to prevent feedback. Then again, why on earth would anyone want to assign the MAIN MIX to the MAIN MIX?

43 METERS – MANY DISPLAYS IN ONE!

The 1402-VLZ PRO's peak metering system is made up of two columns of twelve LEDs. Deceptively simple, considering the multitude of signals that can be monitored by it.

If nothing is selected in the SOURCE matrix 38 and no channels are in SOLO, the METERS will just sit there and look stupid. To put them to work, you must make a selection in the SOURCE matrix (or engage a SOLO switch).

Why? You want the METERS to reflect what the engineer is listening to, and as we've covered, the engineer is listening either to the CONTROL ROOM outputs or the PHONES outputs. The only difference is that while the listening levels are controlled by the CTL ROOM / SUBMIX fader, the METERS read the SOURCE mix before that control, giving you the real facts at all times, even if you're not listening at all.



You may already be an expert at the world of "+4" (+4dBu=1.23V) and "-10" (-10dBV=0.32V) operating levels. Basically, what makes a mixer one or the other is the relative 0dB VU (or 0VU) chosen for the meters. A "+4" mixer, with a +4dBu signal pouring out the back will actually read 0VU on its meters. A "-10" mixer, with a -10dBV signal trickling out, will read, you guessed it, 0VU on its meters. So when is 0VU actually 0dBu? Right now!

At the risk of creating another standard, Mackie's compact mixers address the need of both crowds by calling things as they are — 0dBu (0.775V) at the output shows as 0dB VU on the METERS. What could be easier? By the way, the most wonderful thing about standards is that there are so many to choose from.

Thanks to the 1402-VLZ PRO's wide dynamic range, you can get a good mix with peaks flashing anywhere between -20 and +10dB on the METERS. Most amplifiers clip at about +10dB, and some recorders aren't so forgiving either. For best real-world results, try to keep your peaks between "0" and "+7."

Remember, audio meters are just tools to help assure you that your levels are "in the ballpark." You don't have to stare at them (unless you want to).



44 AUX TALK

First of all, there is no particular alliance between AUX SEND 1 (or 2) and AUX RETURN 1 (or 2). They're just numbers. They're like two complete strangers, both named Fred.

Here's the whole idea behind sends and returns: sends are outputs, returns are inputs. AUX SENDs tap signals off the channels, via their AUX knobs (34), mix these signals, then send them out via the AUX SEND jacks (21).

These outputs are fed to the inputs of a reverb or other device. From there, the outputs of this external device are fed back to the mixer's AUX RETURN jacks (12). Then these signals are sent through the AUX RETURN level controls, and finally delivered to the MAIN MIX.

So, the original "dry" signals go from the channels to the MAIN MIX and the affected "wet" signals go from the Aux Returns to the MAIN MIX, and once mixed together, the dry and wet signals combine to create a glorious sound. So, armed with this knowledge, let's visit the Auxiliary World:

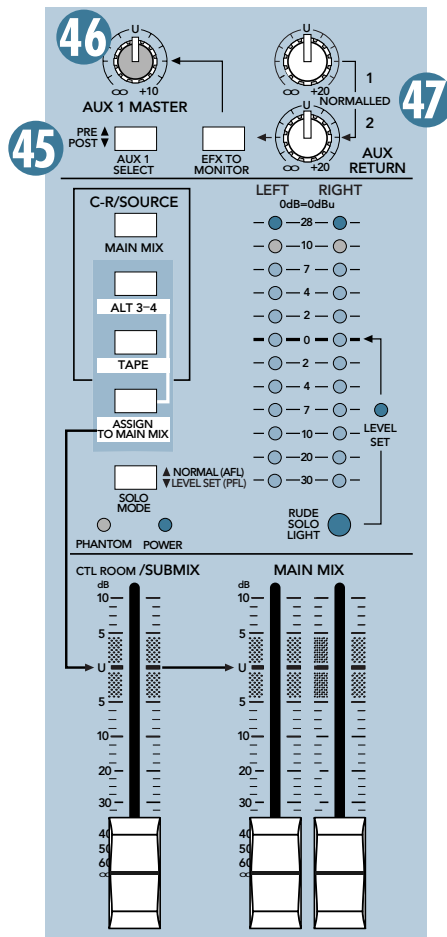

45 AUX 1 SELECT

Besides being used to work effects into your mix, Aux Sends serve another critical role — that of delivering cue mixes to stage monitors, so musicians can hear what they're doing. On the 1402-VLZ PRO, AUX SEND 1 can play either role, depending on the position of this switch.

With the AUX 1 SELECT switch up (disengaged), AUX SEND 1 will tap a channel *pre*-FADER and *pre*-MUTE/ALT 3-4, meaning that no matter how you manipulate those controls as they feed the MAIN MIX, the AUX SEND will continue to belt out a constant signal level. This is the preferred method for setting up stage monitor feeds. EQ settings will affect all AUX SENDS.

With the switch down, AUX SEND 1 becomes an ordinary effects send — *post*-FADER and *post*-MUTE/ALT 3-4. This is a must for effects sends, since you want the levels of your "wet" signals to follow the level of the "dry."

46 AUX 1 MASTER

The AUX 1 MASTER provides overall level control of AUX SEND 1, just before it's delivered to the AUX 1 OUTPUT. (AUX SEND 2 has no such control.) This knob goes from *off* (turned fully down), to Unity gain at the center detent, with 10dB of extra gain (turned fully up). As with some other level controls, you may never need the additional gain, but if you ever do, you'll be glad you bought a Mackie.

This is usually the knob you turn up when the lead singer glares at you, points at his stage monitor, and sticks his thumb up in the air. (It would follow suit that if the singer stuck his thumb down, you'd turn the knob down, but that never happens.)

47 AUX RETURNS

These two controls set the overall level of effects received from STEREO AUX RETURN inputs 1 and 2 (12). These controls are designed to handle a wide range of signal levels, from *off*, to unity gain at the detent, with 20dB gain fully clockwise, to compensate for low-level effects.

Typically, these knobs can just live at the center detent, and the effects device's output control should be set at whatever they call Unity gain (check their manual). If that turns out to be too loud or too quiet, adjust the effects device's outputs, not the mixer. That way, the mixer's knobs are easy to relocate at the center detent.

Signals passing through the AUX RETURN level controls will proceed directly to MAIN MIX 36, with one exception (see next paragraph). The AUX RETURNS do not have MUTE/ALT 3-4 switches, so if you want these signals to get to the ALT 3-4 mix, you'll have to patch the effects device's outputs into one of the stereo channels, and MUTE/ALT that channel 30.

48 EFX TO MONITOR

The idea behind this great feature is simple: If you want to add reverb or delay to the stage monitor mixes, this is the switch for you. The implementation leading up to the switch is the tricky part:

With the switch up, AUX RETURN 1 and 2 behave normally — they deliver their signals into the MAIN MIX. With the switch down, AUX RETURN 1 still behaves normally, but AUX RETURN 2's level control will feed AUX SEND 1 21 instead of the MAIN MIX.

Still with us? Good. So far, with the switch down, we have AUX RETURN 1 feeding the MAIN MIX and AUX RETURN 2 feeding AUX SEND 1. Now, suppose you only have one effects device, and you want it to feed both the MAIN MIX and AUX SEND 1. That's where "jack normalling" comes in.

49 JACK NORMALLING

Jack normalling (not to be confused with Jack Normalling, Chicago Cubs utility infielder, 1952-61, .267 LBA) is a feature found on almost every mixer, keyboard and effects device. These jacks have special spring-loaded pins that connect to the signal pins, but when something is plugged into the jack, that connection is broken.

These normalling pins can be used in all sorts of ways. The ubiquitous phrase "LEFT (MONO)" means that if you plug a signal into the LEFT side and have nothing in the RIGHT side, that signal is also fed to the right input,

courtesy of jack normalling. As soon as you plug something in the RIGHT side, that normalled connection is broken.

How does all this relate to the EFX TO MONITOR switch? AUX RETURN 1's inputs are normalled to AUX RETURN 2. If you have one effects device, plug it into AUX RETURN 1. Plug nothing into AUX RETURN 2. Now the signals feeding the AUX RETURN 1 inputs will also be sent to the AUX RETURN 2 inputs.

Engage the EFX TO MONITOR switch, and now the AUX RETURN 2 knob will become an additional AUX SEND 1 knob for the signal at the AUX RETURN 1 12. Say that ten times! Once again, AUX RETURN 1 will behave normally, as always.

Congratulations! You've just read about all the features of your 1402-VLZ PRO. You're probably ready for a cold one. Go ahead. The rest of the manual can wait.

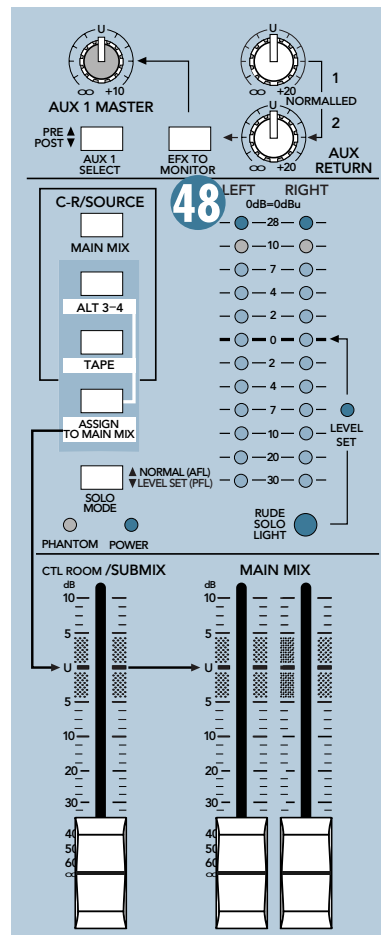

50 MODIFICATIONS

For most folks, the 1402-VLZ PRO works just fine the way it is. But for special applications, there are three signal routing changes that can be performed easily on the 1402-VLZ PRO. Easy for someone with soldering experience, that is. If you don't know how to solder, find a technician that can. This is NOT a good place to learn!

- Modification A changes AUX SEND 2 to be *pre-fader; pre-mute* instead of *post-fader; post-mute*.
- Mod B changes AUX SEND 1 (in *post* mode) and AUX SEND 2 to receive signal regardless of the channel's MUTE/ALT switch position, but still be *post-fader* (GAIN knob).
- Mod C changes the SOURCE matrix's MAIN MIX selection to tap the stereo signal before the MAIN MIX level control (*pre*) instead of after (*post*).

UL Warning

Caution! These modification instructions are for use by qualified personnel only. To avoid electric shock, do not perform any servicing other than changing the fuse unless you are qualified to do so. Refer all servicing and modifying to qualified personnel.

Mackie Disclaimer

Any modification of any Mackie Designs product must be performed by a competent electronic technician. Mackie Designs accepts no responsibility for any damages or injuries caused by any modification, regardless of the source of the modification instructions or the qualifications of the technician performing them. In the case of such damages, Mackie Designs may declare warranty privileges void. BE CAREFUL!

A Note About Jumpers

When installing jumpers, do *not* run their ends through holes in the circuit board. Rather, solder them flat against the desired pad (the flat silver area, possibly with a hole in the middle). Make sure the ends of these flat wires do not extend beyond the pad.

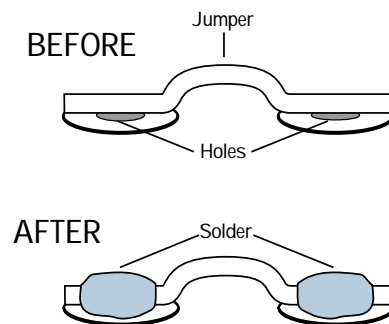

1. PRE-FADER MOD (AUX TO MONITOR)

This modification changes AUX SEND 2 to be *pre-fader, pre-mute* instead of *post-fader, post-mute*. (“Mute” refers to the channel’s MUTE/ALT 3–4 switch.) In order to convert the entire mixer, it must be done on each channel, and is slightly more involved for the stereo channels 7–14. The work area is on the underside of the circuit board, near the channel AUX SEND knobs.

1. Remove all cords, including the power cable, from the 1402-VLZ PRO.
2. Place the mixer upside-down on a dry, non-marring surface.
3. Remove the screws that attach the bottom cover. Keep track of what screws go where. Remove the bottom cover.
4. Using a sharp “X-acto” type knife, cut the conductor at point ‘A’ (channels 1–6) or the conductors at points ‘AL’ and ‘AR’ (channels 7–14). Be careful to cut all the way through the conductor, and do not cut any nearby traces.
5. Add a jumper from point ‘B’ to the square pad at point ‘A’ (channels 1–6) or from points ‘BL’ to ‘AL’ and ‘BR’ to ‘AR’ (channels 7–14).
6. Repeat for all channels.
7. Check your work very carefully, then put the bottom cover back the way you found it. You’re done!

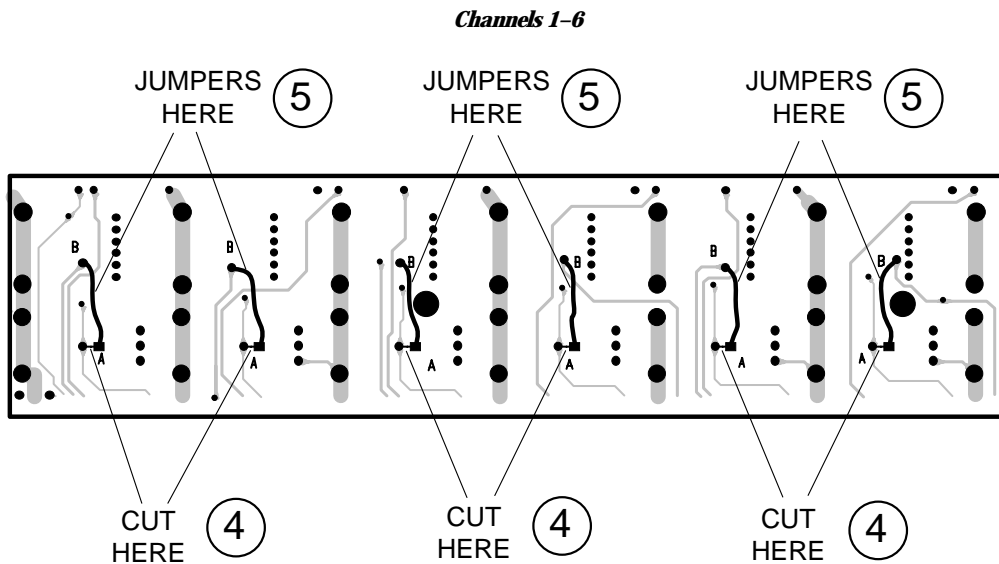

2. PRE-MUTE MOD

This modification changes AUX SEND 1 (in *post* mode) and AUX SEND 2 to receive signal regardless of the channel's MUTE/ALT 3-4 switch position, but still be *post-fader*. In order to convert the entire mixer, it must be done on each channel, and is slightly more involved for the stereo channels 7-14. The work area is on the underside of the circuit board, near the channel MUTE/ALT 3-4 switches.

1. Remove all cords, including the power cable, from the 1402-VLZ PRO.
2. Place the mixer upside-down on a dry, non-marring surface.
3. Remove the screws that attach the bottom cover. Keep track of what screws go where. Remove the bottom cover.
4. Using a sharp "X-acto" type knife, cut the conductor at point 'C' (channels 1-6) or the conductors at points 'CL' and 'CR' (channels 7-14). Be careful to cut all the way through the conductor, and do not cut any nearby traces.
5. Locate the 12 pins that comprise the underside of each MUTE/ALT 3-4 switch.
6. Add jumpers as shown on the illustration below — they're not specifically marked on the circuit board itself, so be careful.
7. Repeat for all channels.
8. Check your work very carefully, then put the bottom cover back the way you found it. You're done!

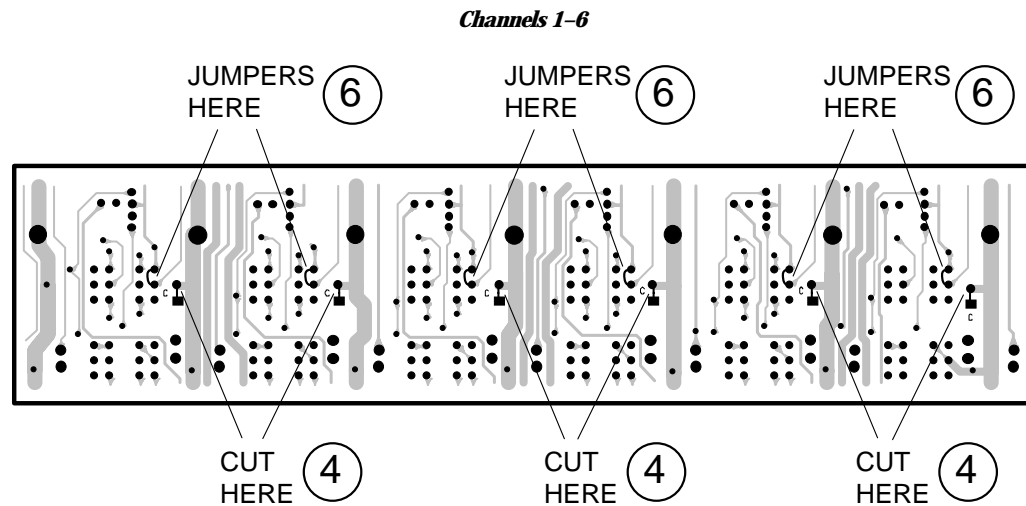

3. MAIN MIX SOURCE MOD

This modification changes the SOURCE matrix's MAIN MIX selection to tap the stereo signal before the MAIN MIX level control (*pre*) instead of after (*post*). This could be especially handy for live work where the engineer wants to be able to control the MAIN MIX level (sent to the house system) without changing the level in his headphones. The work area is on the underside of the circuit board, near the MAIN MIX level control.

Caution: This modification also causes the meters to indicate pre MAIN MIX levels. They will not longer indicate the signal level at the MAIN OUTS, but rather the signal level at the PHONES and CONTROL ROOM outputs (when MAIN MIX SOURCE is selected).

1. Remove all cords, including the power cable, from the 1402-VLZ.PRO.
2. Place the mixer upside-down on a dry, non-marring surface.
3. Remove the screws that attach the bottom cover. Keep track of what screws go where. Remove the bottom cover.
4. Using a sharp "X-acto" type knife, cut the conductor at points 'XL' and 'XR'. Be careful to cut all the way through the conductor, and do not cut any nearby traces.
5. Add a jumper from point 'YL' to the square pad at point 'XL' and from point 'YR' to the square pad at point 'XR'.
6. Check your work very carefully, then put the bottom cover back the way you found it. You're done!

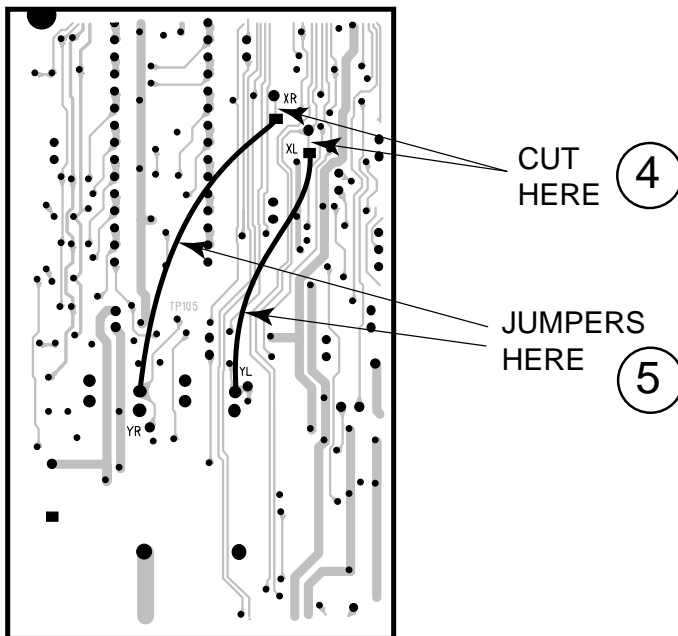

51 1402-VLZ PRO BLOCK DIAGRAM

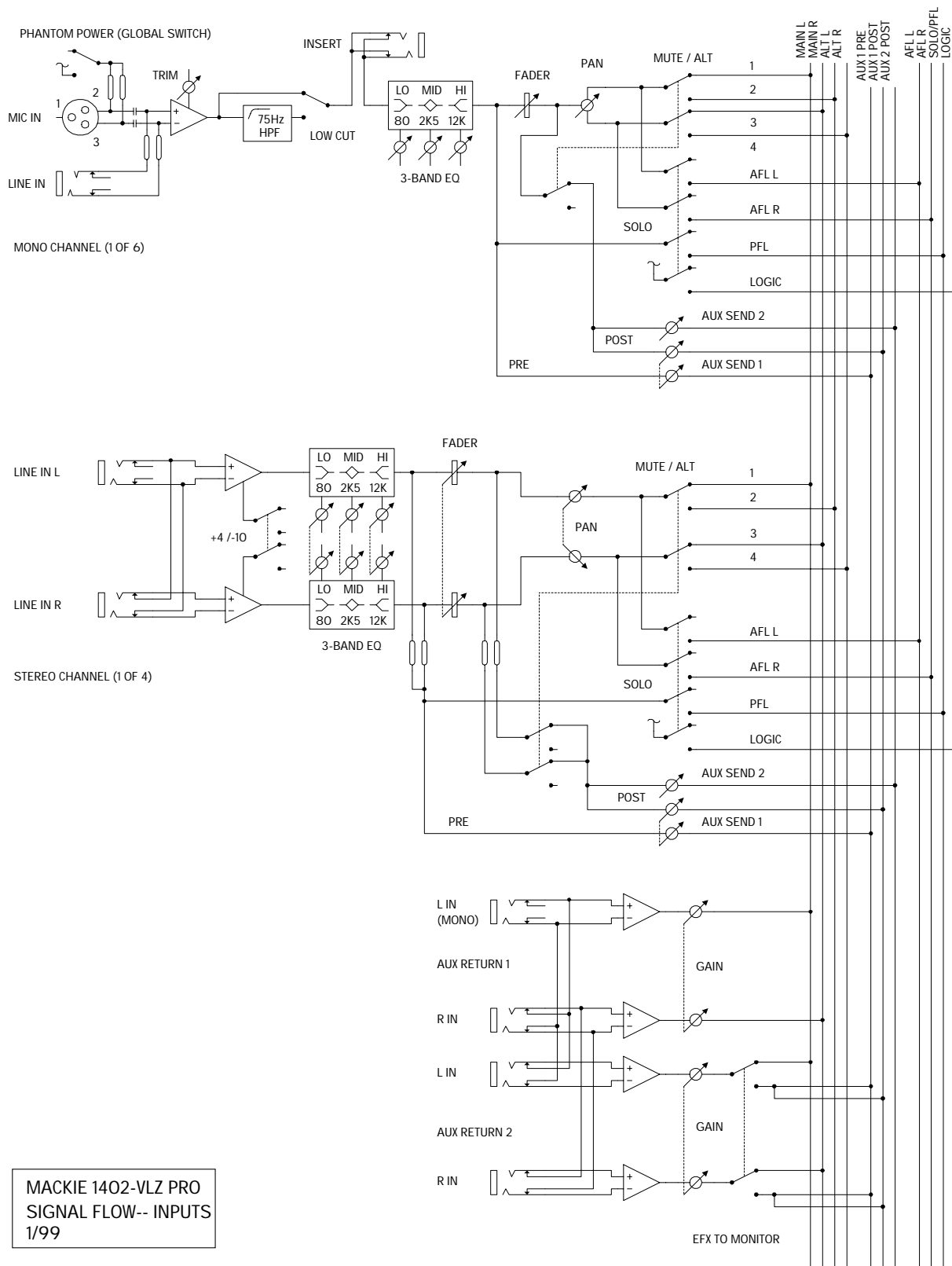

MACKIE 1402-VLZ PRO
SIGNAL FLOW-- INPUTS
1/99

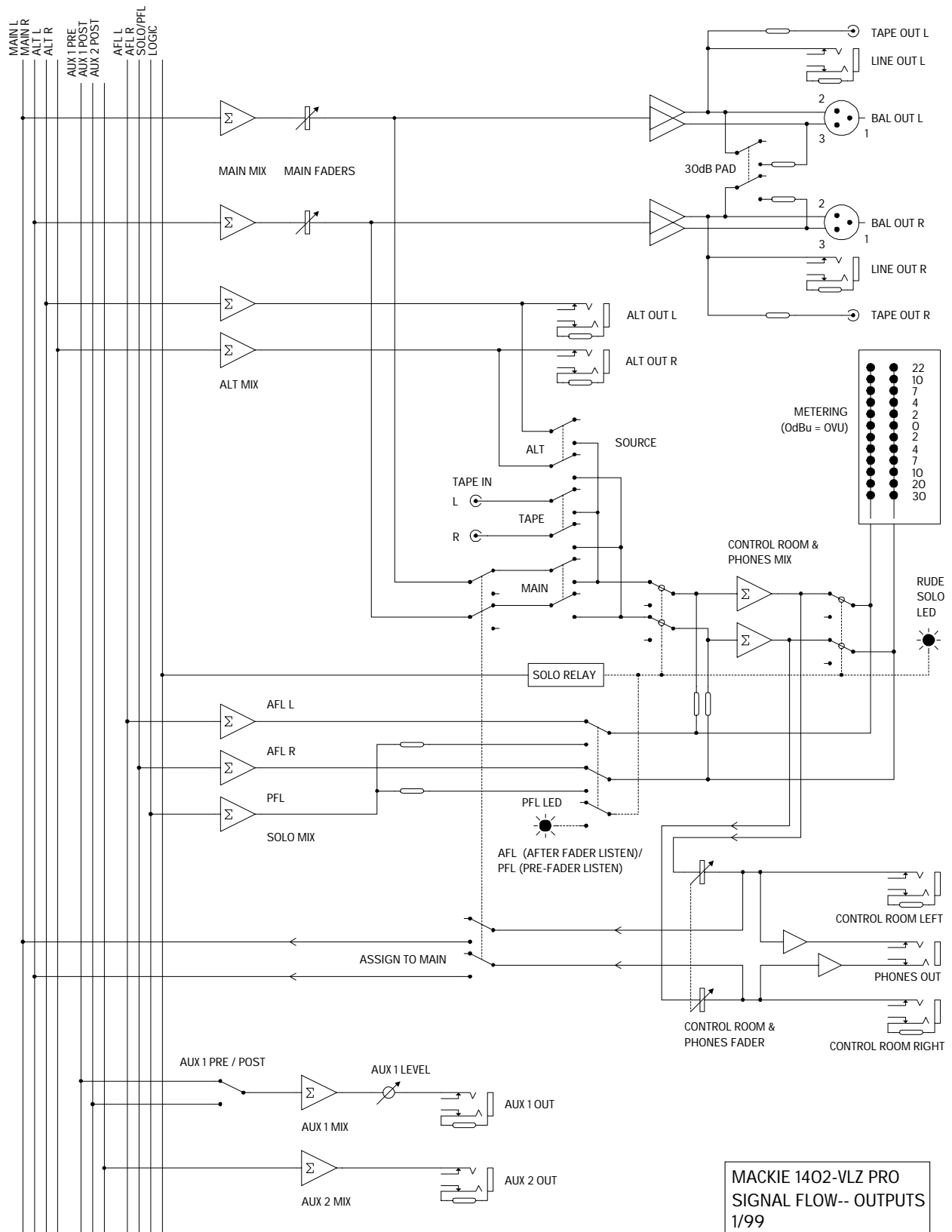

MACKIE 1402-VLZ PRO
 SIGNAL FLOW-- OUTPUTS
 1/99

52 GAIN STRUCTURE DIAGRAM

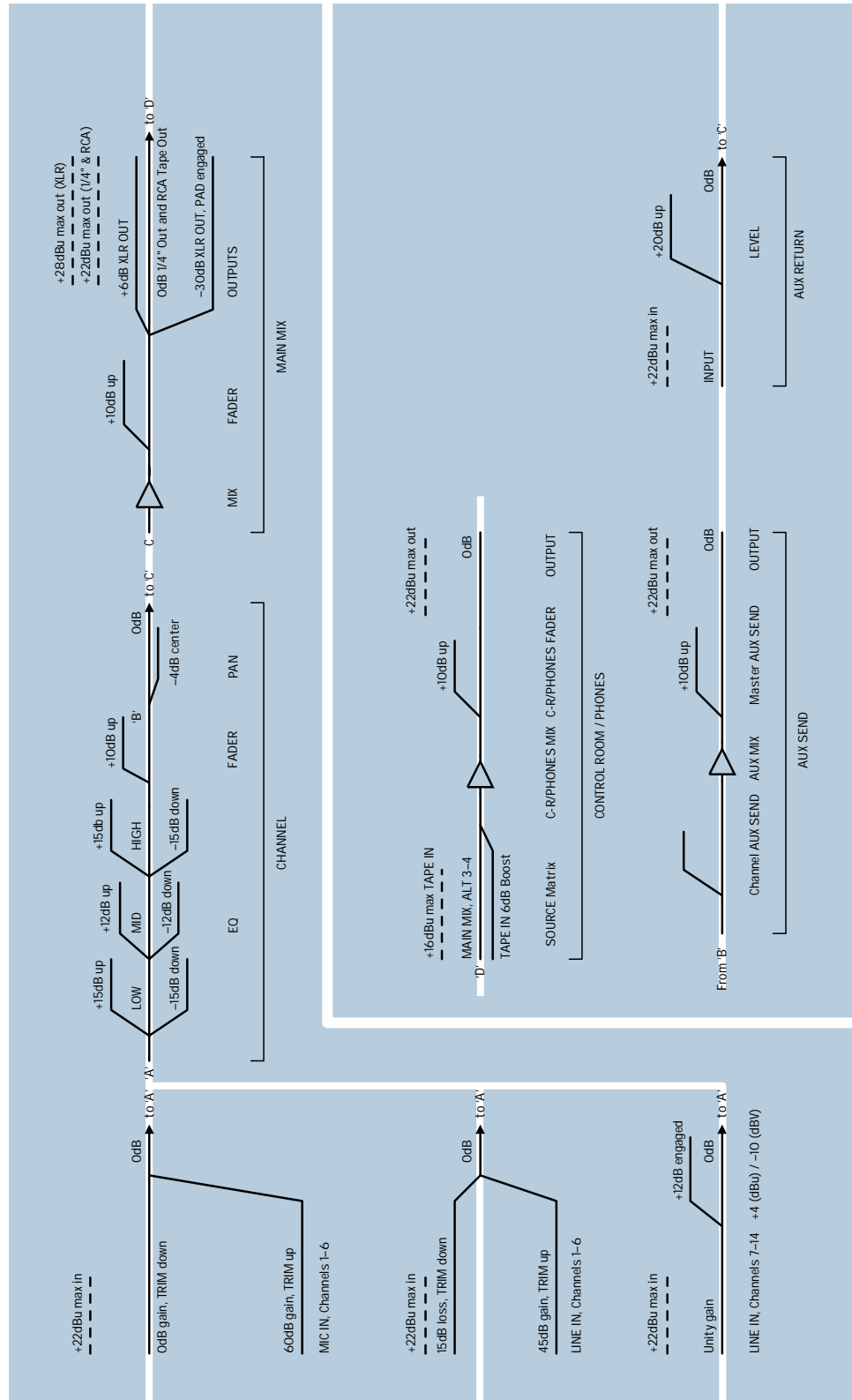

53 SPECIFICATIONS

Main Mix Noise

20Hz–20kHz bandwidth, 1/4" Main out, channels 1–6 Trim @ unity gain, channel EQs flat, all channels assigned to Main Mix, channels 1 and 3 Pan left, 2 and 4 Pan right.

Main Mix fader down, channel faders down: -100.0dBu

Main Mix fader unity, channel faders down: -86.5dBu (90dB Signal-to-Noise Ratio, ref +4dBu)

Main Mix fader @ unity, channel faders @ unity: -84.5dBu

Total Harmonic Distortion (THD)

1kHz @ +14dBu, 20Hz–20kHz

Mic in to Main out: 0.0007%

Attenuation (Crosstalk)

1kHz relative to 0dBu, 20Hz–20kHz bandwidth, Line in, 1/4" Main Out, Trim @ unity

Main fader down: -85dBu

Channel Alt / Mute switch engaged: -84dBu

Channel fader down: -83dBu

Frequency Response

Mic input to any output

20Hz to 60kHz: +0dB/-1dB

20Hz to 100kHz: +0dB/-3dB

Equivalent Input Noise (EIN)

Mic in to Insert Send out, max gain

150 ohm termination: -129.5dBm unweighted

Common Mode Rejection (CMR)

Mic in to Insert Send out, max gain

1kHz: better than -90dB

Maximum Levels

Mic in: +22dBu

Tape in: +16dBu

All other inputs: +22dBu

Main Mix XLR out: +28dBu

All other outputs: +22dBu

Impedances

Mic in: 1.3 kilohms

Channel Insert return: 2.5 kilohms

All other inputs: 10 kilohms or greater

Tape out: 1.1 kilohms

All other outputs: 120 ohms

EQ

High Shelving: +/-15db @ 12kHz

Mid Peaking: +/-12dB @ 2.5kHz

Low Shelving: +/-15db @ 80Hz

Power Consumption

120VAC, 50/60Hz, 25 watts

Fuse Rating

120V: 500mA slo blo, 5 x 20mm

220–240V: 250mA slo blo, 5 x 20mm

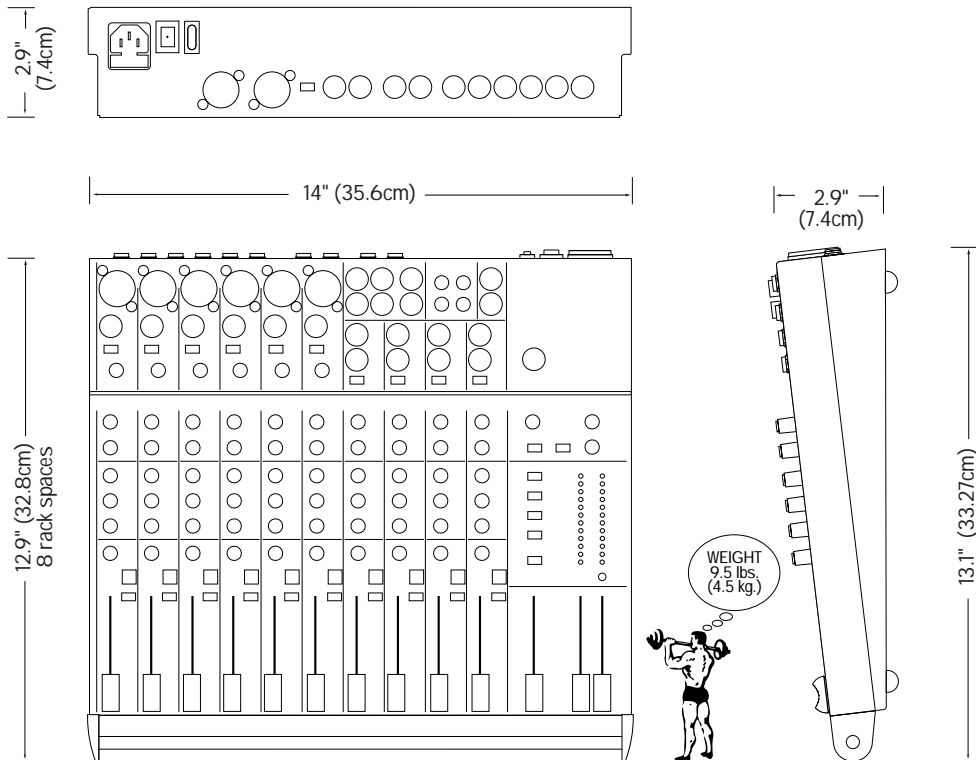

Mackie Designs is always striving to improve our mixers by incorporating new and improved materials, components and manufacturing methods. Because we're always trying to make things better, we reserve the right to change these specifications at any time, without notice.

54 SERVICE INFO

Details concerning Warranty Service are spelled out on the Warranty Card included with your mixer (if it's missing, let us know and we'll rush one to you).

If you think your 1402-VLZ PRO has a problem, please do everything you can to confirm it before calling for service. Doing so might save you from the deprivation of your mixer and the associated suffering.

Of all Mackie products returned for service (which is hardly any at all), roughly 50% are coded "CND" — Could Not Duplicate, which usually means the problem lay somewhere other than the mixer. These may sound obvious to you, but here's some things you can check:

TROUBLESHOOTING

Bad Channel

- Is the MUTE/ALT 3–4 switch in the correct position?
- Is the fader turned up?
- Try unplugging any INSERT devices (Channels 1–6 only).
- Try the same source signal in another channel, set up exactly like the suspect channel.

Bad Output

- Is the associated level control (if any) turned up?
- If it's one of the Main outputs, try unplugging all the others. For example, if it's the ¼" Left Main out, unplug the RCA and XLR Left outputs. If the problem goes away its not the mixer.
- If it's a stereo pair, try switching them around. For example, if a left output is presumed dead, switch the left and right cords, at the mixer end. If the problem stays on the left it's not the mixer.

Noise

- Turn the channel fader and AUX RETURN knobs down, one by one. If the sound disappears, it's either that channel or whatever is plugged into it, so unplug whatever that is. If the noise disappears, it's from your whatever.

Power

- Our favorite question: Is the POWER switch on?
- Check the fuse 23.

REPAIR

Service for the U.S. version of the 1402-VLZ PRO is available only from Mackie Designs, located in sunny Woodinville, Washington.

(Service for mixers living outside the United States can be obtained through local dealers or distributors.) If your mixer needs service, follow these instructions:

1. Review the preceding troubleshooting suggestions. Please.
2. Call Tech Support at 1-800-258-6883, 8am to 5pm PST, to explain the problem and request an RA number. Have your mixer's serial number ready. **You must have a Return Authorization number; or we may refuse the delivery.**
3. Set aside the power cord, owner's manual, or anything else that you'll ever want to see again. We are responsible for the return of the mixer only.
4. Pack the mixer in its original package, including endcaps and box. This is **VERY IMPORTANT**. When you call for the RA number, please let Tech Support know if you need a new box. *Mackie is not responsible for any damage that occurs due to non-factory packaging.*
5. Include a legible note stating your name, shipping address (no P.O. boxes), daytime phone number, RA number and a detailed description of the problem, including how we can duplicate it.
6. Write the RA number in **BIG PRINT** on top of the box.
7. Ship the mixer to us. We recommend United Parcel Service (UPS). We suggest insurance for all forms of cartage. Ship to this address:

**Mackie Designs
SERVICE DEPARTMENT
16220 Wood-Red Rd. NE
Woodinville, WA 98072**

8. We'll try to fix the mixer within three business days. Ask Tech Support for the latest turn-around times when you call for your RA number. We normally send everything back prepaid using UPS BLUE (Second Day Air). However, if you rush your mixer to us by Next Day Air, we'll ship it back to you UPS RED (Next Day Air). This paragraph does not necessarily apply to non-warranty service.

APPENDIX A: GLOSSARY

This Glossary contains brief definitions of many of the audio and electronic terms used in discussions of sound mixing and recording. Many of the terms have other meanings or nuances or very rigorous technical definitions which we have sidestepped here because we figure you already have a lot on your mind. If you'd like to get more information, you can call Mix Bookshelf at 1-800-233-9604. We recommend the following titles: *The Audio Dictionary*, by Glenn White; *Tech Terms*, by Peterson & Oppenheimer; *Handbook for Sound Engineers*, by Glen Ballou; *Mackie Mixer Book* by Rudy Trubitt and *Sound Reinforcement Handbook*, by Gary Davis.

AFL

An acronym for After Fade Listen, which is another way of saying post-fader solo function.

assign

In sound mixers, *assign* means to switch or route a signal to a particular signal path or combination of signal paths.

attenuate

To reduce or make quieter.

aux

See next entry.

auxiliary

In sound mixers, supplemental equipment or features that provide additional capabilities to the basic system. Examples of auxiliary equipment include: serial processors (equalizers, compressors, limiters, gates) and parallel devices (reverberation and delay). Most mixers have aux send buses and aux return inputs to accommodate auxiliary equipment.

balanced

In a classic balanced audio circuit, the two legs of the circuit (+ and -) are isolated from the circuit ground by exactly the same impedance. Additionally, each leg may carry the signal at exactly the same level but with opposite polarity with respect to ground. In some balanced circuits, only one leg actually carries the signal but both legs exhibit the same impedance characteristics with respect to ground. Balanced input circuits can offer excellent rejection of common-mode noise induced into the line and also make proper (no ground loops) system grounding easier. Usually terminated with ¼" TRS or XLR connectors.

bandwidth

The band of frequencies that pass through a device with a loss of less than 3dB, expressed in Hertz or in musical octaves. Also see *Q*.

bus

An electrical connection common to three or more circuits. In mixer design, a bus usually carries signals from a number of inputs to a mixing amplifier, just like a city bus carries people from a number of neighborhoods to their jobs.

Cannon

A manufacturer of electrical connectors who first popularized the three-pin connector now used universally for balanced microphone connections. In sound work, a Cannon connector is taken to mean a Cannon XLR-3 mic connector or any compatible connector.

cardioid

Means heart-shaped. In sound work, cardioid refers to the shape of the sensitivity pattern of some directional microphones.

channel

A functional path in an audio circuit: an input channel, an output channel, a recording channel, the left channel and so on.

channel strip

The physical representation of an audio channel on the front panel of a mixer; usually a long, vertical strip of controls.

chorusing

An effect available in some digital delay effects units and reverbs. Chorusing involves a number of moving delays and pitch shifting, usually panned across a stereo field. Depending on how used, it can be lovely or grotesque.

clipping

A cause of severe audio distortion that is the result of excessive gain requiring the peaks of the audio signal to rise above the capabilities of the amplifier circuit. Seen on an oscilloscope, the audio peaks appear clipped off. To avoid distortion, reduce the system gain in or before the gain stage in which the clipping occurs. See also headroom.

condenser

Another term for the electronic component generally known as a capacitor. In audio, condenser usually refers to a type of microphone that uses a capacitor as the sound pickup element. Condenser microphones require electrical power to run internal amplifiers and maintain an electrical charge on the capacitor. They are typically powered by internal batteries or “phantom power” supplied by an external source, such as a mixing console.

console

A term for a sound mixer, usually a large desk-like mixer.

cueing

In broadcast, stage and post-production work, to “cue up” a sound source (a record, a sound effect on a CD, a song on a tape) means to get it ready for playback by making sure you are in the right position on the “cue,” making sure the level and EQ are all set properly. This requires a special monitoring circuit that only the mixing engineer hears. It does not go out on the air or to the main mixing buses. This “cueing” circuit is the same as pre-fader (PFL) solo on a Mackie mixer, and often the terms are interchangeable.

dB

See *decibel*

dBm

A unit of measurement of audio signal level in an electrical circuit, expressed in decibels referenced to 1 milliwatt. The “m” in dBm stands for “milliwatt.” In a circuit with an impedance of 600 ohms, this reference (0dBm) corresponds to a signal voltage of 0.775 VRMS (because 0.775 V across 600 ohms equals 1mw).

dBu

A unit of measurement of audio signal level in an electrical circuit, expressed in decibels referenced to 0.775 VRMS into any impedance. Commonly used to describe signal levels within a modern audio system.

dBv

A unit of measurement equal to the dBu but no longer in use. It was too easy to confuse a dBv with a dBV, to which it is not equivalent.

dBV

A unit of measurement of audio signal level in an electrical circuit, expressed in decibels referenced to 1 VRMS across any impedance. Commonly used to describe signal levels in consumer equipment. To convert dBV to dBu, add 2.2dB.

decibel (dB)

The dB is a ratio of quantities measured in similar terms using a logarithmic scale. Many audio system parameters measure over such a large range of values that the dB is used to simplify the numbers. A ratio of 1000V:1V=60dB. When one of the terms in the ratio is an agreed upon standard value such as 0.775V, 1V or 1mw, the ratio becomes an absolute value, i.e., +4dBu, -10dBV or 0dBm.

delay

In sound work, delay usually refers to an electronic circuit or effects unit whose purpose it is to delay the audio signal for some short period of time. Delay can refer to one short repeat, a series of repeats or the complex interactions of delay used in chorusing or reverb. When delayed signals are mixed back with the original sound, a great number of audio effects can be generated, including phasing and flanging, doubling, Haas-effect positioning, slap or slapback, echo, regenerative echo, chorusing and hall-like reverberation. Signal time delay is central to many audio effects units.

detent

A point of slight physical resistance (a click-stop) in the travel of a knob or slide control, used in Mackie mixers to indicate unity gain.

dipping

The opposite of peaking, of course. A dip is an EQ curve that looks like a valley, or a dip. Dipping with an equalizer reduces a band of frequencies. (See guacamole.)

doubling

A delay effect, where the original signal is mixed with a medium (20 to 50 msec) delay. When used carefully, this effect can simulate double-tracking (recording a voice or instrument twice).

dry

Usually means without reverberation, or without some other applied effect like delay or chorusing. Dry is not wet, i.e. totally unaffected.

dynamic

In sound work, dynamic refers to the class of microphones that generate electrical signals by the movement of a coil in a magnetic field. Dynamic microphones are rugged, relatively inexpensive, capable of very good performance and do not require external power.

dynamic range

The range between the maximum and minimum sound levels that a sound system can handle. It is usually expressed in decibels as the difference between the level at peak clipping and the level of the noise floor.

echo

The reflection of sound from a surface such as a wall or a floor. Reverberation and echo are terms that can be used interchangeably, but in audio parlance a distinction is usually made: echo is considered to be a distinct, recognizable repetition (or series of repetitions) of a word, note, phrase or sound, whereas reverberation is a diffuse, continuously smooth decay of sound. Echo and reverberation can be added in sound mixing by sending the original sound to an electronic (or electronic/acoustic) system that mimics natural echoes, and then some. The added echo is returned to the blend through additional mixer inputs. Highly echoic rooms are called live; rooms with very little echo are called dead. A sound source without added echo is dry; one with reverb or echo added is wet.

effects devices

External signal processors used to add reverb, delay, spatial or psychoacoustic effects to an audio signal. An effects processor may be used as an insert processor (serial) on a particular input or subgroup, or it may be used via the aux send/return system (parallel). See also *echo*, *reverb*.

EIN

Equivalent Input Noise. Specification that helps measure the “quietness” of a gain stage by deriving the equivalent input noise voltage necessary to obtain a given preamp’s output noise. Typically ranges from -125 to -129.5 dBm.

EQ

See *equalization*

EQ curve

A graph of the response of an equalizer, with frequency on the x (horizontal) axis and amplitude (level) on the y (vertical) axis. Equalizer types and effects are often named after the shape of the graphed response curve, such as peak, dip, shelf, notch, knee and so on.

equalization

Equalization (EQ) refers to purposefully changing the frequency response of a circuit, sometimes to correct for previous unequal response (hence the term, equalization), and more often to add or subtract level at certain frequencies for sound enhancement, to remove extraneous sounds, or to create completely new and different sounds.

Bass and treble controls on your stereo are EQ; so are the units called parametrics and graphics and notch filters.

A lot of how we refer to equalization has to do with what a graph of the frequency response would look like. A flat response (no EQ) is a straight line; a peak looks like a hill, a dip is a valley, a notch is a really skinny valley, and a shelf looks like a plateau (or a shelf). The slope is the grade of the hill on the graph.

Graphic equalizers have enough frequency slider controls to form a graph of the EQ right on the front panel. Parametric EQs let you vary several EQ parameters at once. A filter is simply a form of equalizer that allows certain frequencies through unmolested while reducing or eliminating other frequencies.

Aside from the level controls, EQs are probably the second most powerful controls on any mixer (no, the power switch doesn’t count!).

fader

Another name for an audio level control. Today, the term refers to a straight-line slide control rather than a rotary control.

family of curves

A composite graph showing on one chart several examples of possible EQ curves for a given equalizer or equalizer section.

filter

A simple equalizer designed to remove certain ranges of frequencies. A low-cut filter (also called a high-pass filter) reduces or eliminates frequencies below its cutoff frequency. There are also high-cut (low-pass) filters, bandpass filters, which cut both high and low frequencies but leave a band of frequencies in the middle untouched, and notch filters, which remove a narrow band but leave the high and low frequencies alone.

flanging

A term for phasing. Before digital delay effects units, phasing could be accomplished by playing two tape machines in synchronization, then delaying one slightly by rubbing a finger on the reel flange. Get it?

FOH

An acronym for Front Of House. See *house* and *main house speakers*.

frequency

The number of times an event repeats itself in a given period. Sound waves and the electrical signals that represent sound waves in an audio circuit have repetitive patterns that range from a frequency of about 20 repetitions per second to about 20,000 repetitions per second. Sound is the vibration or combination of vibrations in this range of 20 to 20,000 repetitions per second, which gives us the sensation of pitch, harmonics, tone and overtones. Frequency is measured in units called Hertz (Hz). One Hertz is one repetition or cycle per second.

gain

The measure of how much a circuit amplifies a signal. Gain may be stated as a ratio of input to output values, such as a voltage gain of 4, or a power gain of 1.5, or it can be expressed in decibels, such as a line amplifier with a gain of 10dB.

gain stage

An amplification point in a signal path, either within a system or a single device. Overall system gain is distributed between the various gain stages.

graphic EQ

A graphic equalizer uses slide pots for its boost/cut controls, with its frequencies evenly spaced through the audio spectrum. In a perfect world, a line drawn through the centers of the control shafts would form a graph of the frequency response curve. Get it? Or, the positions of the slide pots give a graphic representation of boost or cut levels across the frequency spectrum.

ground

Also called earth. Ground is defined as the point of zero voltage in a circuit or system, the reference point from which all other voltages are measured. In electrical systems, ground connections are used for safety purposes, to keep equipment chassis and controls at zero voltage and to provide a safe path for errant currents. This is called a safety ground.

Maintaining a good safety ground is always essential to prevent electrical shock. Follow manufacturer's suggestions and good electrical practices to ensure a safely grounded system. Never remove or disable the grounding pin on the power cord.

In computer and audio equipment, tiny currents and voltages can cause noise in the circuits and hamper operation. In addition to providing safety, ground provisions in these situations serve to minimize the pickup, detection and distribution of these tiny noise signals. This type of ground is often called technical ground.

Quality audio equipment is designed to maintain a good technical ground and also operate safely with a good safety ground. If you have noise in your system due to technical grounding problems, check your manual for wiring tips or call technical support. Never disable the safety ground to reduce noise problems.

ground loop

A ground loop occurs when the technical ground within an audio system is connected to the safety ground at more than one place. Two or more connections will allow tiny currents to flow in the loops created, possibly inducing noise (hum) in the audio system. If you have noise in your system due to ground loops, check your manual for wiring tips or call technical support. Never disable the safety ground to reduce noise problems.

Haas effect

A psychoacoustic effect in which the time of arrival of a sound to the left and right ears affects our perception of direction. If a signal is presented to both ears at the same time at the same volume, it appears to be directly in front of us. But if the signal to one ear, still at the same volume, is delayed slightly (0 to 5 msec), the sound appears to be coming from the earlier (non-delayed) side.

headroom

The difference between nominal operating level and peak clipping in an audio system. For example, a mixer operating with a nominal line level of +4dBu and a maximum output level of +22dBu has 18dB of headroom. Plenty of room for surprise peaks.

Hertz

The unit of measure for frequency of oscillation, equal to 1 cycle per second. Abbreviated Hz. KHz is pronounced “kay-Hertz” and is an abbreviation for kilohertz, or 1000 Hertz.

house

In Sound Reinforcement parlance, “house” refers to the systems (and even persons) responsible for the primary sound reinforcement in a given hall, building, arena or “house.” Hence we have the house mixer or house engineer, the house mix, the house mix amps, the main house speakers and so on.

Hz

See *Hertz*.

impedance

The A.C. resistance/capacitance/inductance in an electrical circuit, measured in ohms. In audio circuits (and other AC circuits) the impedance in ohms can often be much different from the circuit resistance as measured by a DC ohmmeter.

Maintaining proper circuit impedance relationships is important to avoid distortion and minimize added noise. Mackie input and output impedances are set to work well with the vast majority of audio equipment.

input module

A holdover from the days when the only way that real consoles were built was in modular fashion, one channel per module. See *channel strip*.

knee

A knee is a sharp bend in an EQ response curve not unlike the sharp bend in your leg. Also used in describing dynamics processors.

level

Another word for signal voltage, power, strength or volume. Audio signals are sometimes classified according to their level. Commonly used levels are: microphone level (–40dBu or lower), instrument level (–20 to –10dBu), and line level (–10 to +30dBu).

line level

A signal whose level falls between –10dBu and +30dBu.

main house speakers

The main loudspeakers for a sound reinforcement system. These are usually the largest and loudest loudspeakers, and are usually positioned so that their sound seems to come from the area of the main stage.

mains

See *main house speakers*.

master

A control affecting the final output of a mixer. A mixer may have several master controls, which may be slide faders or rotary controls.

mic amp

See *mic preamp*.

mic level

The typical level of a signal from a microphone. A mic level signal (usually but not always coming from a microphone) is generally below –30dBu. With a very quiet source (a pin dropping?) the signal can be –70dBu or lower. It is also possible for some microphones to deliver more signal than this, in which case it may be referred to as a “hot” mic level. Alternatively, you can just say, “Boy, is that loud!”

mic pre

See *mic preamp*.

mic preamp

Short for microphone preamplifier. An amplifier that functions to bring the very low signal level of a microphone (approximately –50dBu) up to line level (approximately 0dBu). Mic preamps often have their own volume control, called a trim control, to properly set the gain for a particular source. Setting the mic preamp gain correctly with the trim control is an essential step in establishing good noise and headroom for your mix.

mixer

An electronic device used to combine various audio signals into a common output. Different from a blender, which combines various fruits into a common libation.

monaural

Literally, pertaining to or having the use of only one ear. In sound work, monaural has to do with a signal which, for purposes of communicating audio information, has been confined to a single channel. One microphone is a mono pickup; many microphones mixed to one channel is a mono mix; a mono signal played through two speakers is still mono, since it only carries one channel of information. Several monaural sources, however, can be panned into a stereo (or at least two-channel, if you are going to be picky) mix. Monaural SR is common for environments where stereo SR would provide an uneven reproduction to the listener.

monitor

In sound reinforcement, monitor speakers (or monitor headphones or in-the-ear monitors) are those speakers used by the performers to hear themselves. Monitor speakers are also called foldback speakers. In recording, the monitor speakers are those used by the production staff to listen to the recording as it progresses. In zoology, the monitor lizard is the lizard that observes the production staff as the recording progresses. Keep the lizard out of the mixer.

mono

Short for monaural.

mult

Probably short for multiple. In audio work, a mult is a parallel connection in a patch bay or a connection made with patch cords to feed an output to more than one input. A “Y” cable is a type of mult connection. Also a verb, as in “Why did you mult the flanger into every input in the board?”

noise

Whatever you don’t want to hear. Could be hum, buzz or hiss; could be crosstalk or digital hash or your neighbor’s stereo; could be white noise or pink noise or brown noise; or it could be your mother-in-law reliving the day she had her gallstone removed.

noise floor

The residual level of noise in any system. In a well designed mixer, the noise floor will be a quiet hiss, which is the thermal noise generated by bouncing electrons in the transistor junctions. The lower the noise floor and the higher the headroom, the more usable dynamic range a system has.

pan, pan pot

Short for panoramic potentiometer. A pan pot is used to position (or even move back and forth) a monaural sound source in a stereo mixing field by adjusting the source’s volume between the left and right channels. Our brains sense stereo position by hearing this difference in loudness when the sound strikes each ear, taking into account time delay, spectrum, ambient reverberation and other cues.

parametric EQ

A “fully” parametric EQ is an extremely powerful equalizer that allows smooth, continuous control of each of the three primary EQ parameters (frequency, gain, and bandwidth) in each section independently. “Semi” parametric EQs allow control of fewer parameters, usually frequency and gain (i.e., they have a fixed bandwidth, but variable center frequency and gain).

peaking

The opposite of dipping, of course. A peak is an EQ curve that looks like a hill, or a peak. Peaking with an equalizer amplifies a band of frequencies.

PFL

An acronym for Pre Fade Listen. Broadcasters would call it cueing. Sound folks call it being able to solo a channel with the fader down.

phantom power

A system of providing electrical power for condenser microphones (and some electronic pickup devices) from the sound mixer. The system is called phantom because the power is carried on standard microphone audio wiring in a way that is “invisible” to ordinary dynamic microphones. Mackie mixers use standard +48 volt DC power, switchable on or off. Most quality condenser microphones are designed to use +48 VDC phantom power. Check the manufacturer’s recommendations.

Generally, phantom power is safe to use with non-condenser microphones as well, especially dynamic microphones. However, unbalanced microphones, some electronic equipment (such

as some wireless microphone receivers) and some ribbon microphones can short out the phantom power and be severely damaged. Check the manufacturer's recommendations and be careful!

phasing

A delay effect, where the original signal is mixed with a short (0 to 10 msec) delay. The time of the delay is slowly varied, and the combination of the two signals results in a dramatic moving comb-filter effect. Phasing is sometimes imitated by sweeping a comb-filter EQ across a signal. A comb filter can be found in your back pocket.

phone jack

Ever see those old telephone switchboards with hundreds of jacks and patch cords and plugs? Those are phone jacks and plugs, now used widely with musical instruments and audio equipment. A phone jack is the female connector, and we use them in 1/4" two-conductor (TS) and three-conductor (TRS) versions.

phone plug

The male counterpart to the phone jack, right above.

phono jack

See *RCA phono jack*.

phono plug

See *RCA phono plug*.

post-fader

A term used to describe an aux send (usually) that is connected so that it is affected by the setting of the associated channel fader. Sends connected this way are typically (but not always) used for effects. See *pre-fader*.

pot, potentiometer

In electronics, a variable resistor that varies the potential, or voltage. In audio, any rotary or slide control.

pre-fader

A term used to describe an aux send (usually) that is connected so that it is not affected by the setting of the associated channel fader. Sends connected this way are typically (but not always) used for monitors (foldback). See *post-fader*.

proximity effect

The property of many directional microphones to accentuate their bass response when the source-to-mic distance is small, typically three inches or less. Singers generally like this effect even more than singing in the shower.

Q

A way of stating the bandwidth of a filter or equalizer section. An EQ with a Q of .75 is broad and smooth, while a Q of 10 gives a narrow, pointed response curve. To calculate the value of Q, you must know the center frequency of the EQ section and the frequencies at which the upper and lower skirts fall 3dB below the level of the center frequency. Q equals the center frequency divided by the difference between the upper and lower -3dB frequencies. A peaking EQ centered at 10kHz whose -3dB points are 7.5kHz and 12.5kHz has a Q of 2.

RCA phono jack—or RCA jack or phono jack

An RCA phono jack is an inexpensive connector (female) introduced by RCA and originally used to connect phonographs to radio receivers and phono preamplifiers. The phono jack was (and still is) widely used on consumer stereo equipment and video equipment but was quietly fading into obscurity in the professional and semi-professional sound world. Then phono jacks began cropping up in early project-studio multitrack recorders, which (unfortunately) gave them a new lease on life since so many stereo recorders are fitted with them we decided we'd have to put a couple on our mixers for your convenience. But make no mistake: the only thing that the phono jack (or plug) has going for it is low cost.

RCA phono plug

The male counterpart to an RCA phono jack. See above.

regeneration

Also called recirculation. A delay effect created by feeding the output of a delay back into itself to cause a delay of the delay of the delay. You can do it right on the front panel of many effects units, or you can route the delay return back into itself on your mixer. Can be a great deal of fun at parties.

return

A return is a mixer line input dedicated to the task of returning processed or added sound from reverb, echo and other effects devices. Depending on the internal routing of your mixer and your own inclination, you could use returns as additional line inputs, or you could route your reverb outputs to ordinary line inputs rather than the returns.

reverberation, reverb

The sound remaining in a room after the source of sound is stopped. It's what you hear in a large tiled room immediately after you've clapped your hands. Reverberation and echo are terms that can be used interchangeably, but in audio parlance a distinction is usually made: reverberation is considered to be a diffuse, continuously smooth decay of sound, whereas echo is a distinct, recognizable repetition of a word, note, phrase or sound. Reverberation and echo can be added in sound mixing by sending the original sound to an electronic (or electronic/acoustic) system that mimics natural reverberation, or worse. The added reverb is returned to the blend through additional mixer inputs. Highly reverberant rooms are called live; rooms with very little reverberation are called dead. A sound source without added reverb is dry; one with reverb or echo added is wet.

RMS

An acronym for root mean square, a conventional way to measure AC voltage and audio signal voltage. Most AC voltmeters are calibrated to read RMS volts. Other conventions include average volts, peak volts and peak-to-peak volts.

send

A term used to describe a secondary mix and output of the input signals, typically used for foldback monitors, headphone monitors or effects devices. Mackie mixers call it an Aux Send.

shelving

A term used to describe the shape of an equalizer's frequency response. A shelving equalizer's response begins to rise (or fall) at some frequency and continues to fall (or rise)

until it reaches the shelf frequency, at which point the response curve flattens out and remains flat to the limits of audibility. If you were to graph the response, it would look like a shelf. Or more like a shelf than a hiking boot. The EQ controls on your stereo are usually shelving equalizers. See also *peaking* and *dipping*.

slap, slapback

A single-delay echo without any repeats.

Also see *echo*.

solo

Italian for alone. In audio mixers, a solo circuit allows the engineer to listen to individual channels, buses or other circuits singly or in combination with other soloed signals.

SR

An acronym for Sound Reinforcement, which refers to a system of amplifying acoustic and electronic sounds from a performance or speech so that a large audience can hear clearly. Or, in popular music, so that a large audience can be excited, stunned or even partially deafened by the tremendous amplification. Means essentially the same thing as PA (Public Address).

stereo

Believe it or not, stereo comes from a Greek word that means solid. We use stereo or stereophony to describe the illusion of a continuous, spacious soundfield that is seemingly spread around the listener by two or more related audio signals. In practice, stereo often is taken to simply mean two channels.

sweep EQ

An equalizer that allows you to "sweep" or continuously vary the frequency of one or more sections.

symmetrically balanced

See *balanced*.

tinnitus

The ringing in the ears that is produced with prolonged exposure to high volumes. A sound in the ears, such as buzzing, ringing, or whistling, caused by volume knob abuse!

trim

In audio mixers, the gain adjustment for the first amplification stage of the mixer. The trim control helps the mixer cope with the widely varying range of input signals that come from real-world sources. It is important to set the trim control correctly; its setting determines the overall noise performance in that channel of the mixer. See *mic preamp*.

TRS

Acronym for Tip-Ring-Sleeve, a scheme for connecting three conductors through a single plug or jack. ¼" phone plugs and jacks and ⅛" mini phone plugs and jacks are commonly wired TRS. Since the plug or jack can carry two signals and a common ground, TRS connectors are often referred to as stereo or balanced plugs or jacks. Another common TRS application is for insert jacks, used for inserting an external processor into the signal path. In Mackie mixers the tip is send, ring is return, and sleeve is ground.

TS

Acronym for Tip-Sleeve, a scheme for connecting two conductors through a single plug or jack. ¼" phone plugs and jacks and ⅛" mini phone plugs and jacks are commonly wired TS. Sometimes called mono or unbalanced plugs or jacks. A ¼" TS phone plug or jack is also called a standard phone plug or jack.

unbalanced

An electrical circuit in which the two legs of the circuit are not balanced with respect to ground. Usually, one leg will be held at ground potential. Unbalanced circuit connections require only two conductors (signal "hot" and ground). Unbalanced audio circuitry is less expensive to build but under certain circumstances is more susceptible to noise pickup.

unity gain

A circuit or system that has its voltage gain adjusted to be one, or unity. A signal will leave a unity gain circuit at the same level at which it entered. In Mackie mixers, unity gain is achieved by setting all variable controls to the marked "U" setting. Mackie mixers are optimized for best headroom and noise figures at unity gain.

VLZ

Acronym for very low impedance. (Impedance is measured in ohms represented by the Ω symbol, which is the last letter of the Greek alphabet. This is how the letter Z is used instead of I.) VLZ is one of the most important reasons why inherent noise levels on Mackie mixing boards are so minuscule. Thermal noise is something that's created by all circuitry and usually transistors and resistors are the worst culprits. The basic rule with thermal noise is: the higher the impedance, the more the noise. Mackie's VLZ design reduces thermal noise by making internal impedances as low as possible in as many places as possible within the console. VLZ is achieved by scaling down resistor values by a factor of three or four – resulting in a corresponding reduction in thermal noise. This is especially true for the console's mixing buses.

volume

Electrical or sound level in an audio system. Perhaps the only thing that some bands have too much of.

VRMS

See *RMS*.

wet

With added reverberation or other effect like echo, delay or chorusing.

XLR connector

See *Cannon*.

APPENDIX B: CONNECTIONS

“XLR” CONNECTORS

Mackie mixers use 3-pin female “XLR” connectors on all microphone inputs, with pin 1 wired to the grounded (earthed) shield, pin 2 wired to the “high” (“hot” or positive polarity) side of the audio signal and pin 3 wired to the “low” (“cold” or negative polarity) side of the signal (Figure A). All totally aboveboard and in full accord with the hallowed standards dictated by the AES (Audio Engineering Society).

Use a male “XLR”-type connector, usually found on the nether end of what is called a “mic cable,” to connect to a female XLR jack.

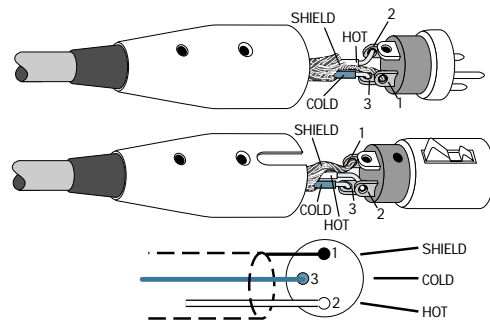

Figure A: XLR Connectors

1/4" TRS PHONE PLUGS AND JACKS

“TRS” stands for Tip-Ring-Sleeve, the three connections available on a “stereo” 1/4" or “balanced” phone jack or plug. See Figure B. TRS jacks and plugs are used in several different applications:

- Stereo Headphones, and rarely, stereo microphones and stereo line connections. When wired for stereo, a 1/4" TRS jack or

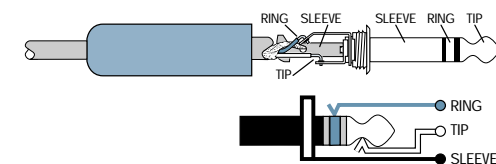

Figure B: 1/4" TRS Plugs

plug is connected tip to left, ring to right and sleeve to ground (earth). Mackie mixers do not directly accept 1-plug-type stereo microphones. They must be separated into a left cord and a right cord, which are plugged into the two mic preamps.

You can cook up your own adapter for a stereo microphone adapter. “Y” two cables out of a female 1/4" TRS jack to two male XLR plugs, one for the Right signal and one for the Left.

- Balanced mono circuits. When wired as a balanced connector, a 1/4" TRS jack or plug is connected tip to signal high (hot), ring to signal low (cold), and sleeve to ground (earth).
- Unbalanced Send/Return circuits. When wired as send/return “Y” connector, a 1/4" TRS jack or plug is connected tip to signal send (output from mixer), ring to signal return (input back into mixer), and sleeve to ground (earth).

1/4" TS PHONE PLUGS AND JACKS

“TS” stands for Tip-Sleeve, the two connections available on a “mono” 1/4" phone jack or plug (Figure C). TS jacks and plugs are used in many different applications, always unbalanced. The tip is connected to the audio signal and the sleeve to ground (earth). Some examples:

- Unbalanced microphones
- Electric guitars and electronic instruments
- Unbalanced line-level connections

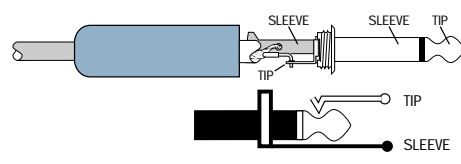

Figure C: TS Plug

SWITCHED 1/4" PHONE JACKS

Switches can be incorporated into 1/4" phone jacks, which are activated by inserting the plug. These switches may open an insert loop in a circuit, change the input routing of the signal or serve other functions. Mackie uses switches in the channel insert and bus insert jacks, input jacks and AUX returns. We also use these switches to ground the line-level inputs when nothing is plugged into them.

In most cases, the plug must be inserted fully to activate the switch. Mackie takes advantage of this in some circuits, specifying circumstances where you are to insert the plug only partially. See **Special Mackie Connections**, later in this section.

RCA PLUGS AND JACKS

RCA-type plugs (also known as phono plugs) and jacks are often used in home stereo and video equipment and in many other applications

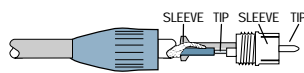

Figure D: RCA Plug

(Figure D). They are unbalanced and electrically identical to a 1/4" TS phone plug or jack (See Figure C). Connect the signal to the center post and the ground (earth) or shield to the surrounding "basket."

UNBALANCING A LINE

In most studio, stage and sound reinforcement situations, there is a combination of balanced and unbalanced inputs and outputs on the various pieces of equipment. This usually will not be a problem in making connections.

- When connecting a balanced output to an unbalanced input, be sure the signal high (hot) connections are wired to each other, and that the balanced signal low (cold) goes to the ground (earth) connection at the unbalanced input. In most cases, the

balanced ground (earth) will also be connected to the ground (earth) at the unbalanced input. If there are ground-loop problems, this connection may be left disconnected at the balanced end.

- When connecting an unbalanced output to a balanced input, be sure that the signal high (hot) connections are wired to each other. The unbalanced ground (earth) connection should be wired to the low (cold) and the ground (earth) connections of the balanced input. If there are ground-loop problems, try connecting the unbalanced ground (earth) connection only to the input low (cold) connection, and leaving the input ground (earth) connection disconnected.

In some cases, you will have to make up special adapters to interconnect your equipment. For example, you may need a balanced XLR female connected to an unbalanced 1/4" TS phone plug.

SPECIAL MACKIE CONNECTIONS

The balanced-to-unbalanced connection has been anticipated in the wiring of Mackie jacks. A 1/4" TS plug inserted into a 1/4" TRS balanced input, for example, will automatically unbalance the input and make all the right connections. Conversely, a 1/4" TRS plug inserted into a 1/4" unbalanced input will automatically tie the ring (low or cold) to ground (earth).

TRS Send/Receive Insert Jacks

Mackie's single-jack inserts are the three-conductor, TRS-type 1/4" phone. They are unbalanced, but have both the mixer output (send) and the mixer input (return) signals in one connector (See Figure F).

The sleeve is the common ground (earth) for both signals. The send from the mixer to the external unit is carried on the tip, and the return from the unit to the mixer is on the ring.

Using the Send Only on an Insert Jack

If you insert a TS (mono) ¼" plug only partially (to the first click) into a Mackie insert jack, the plug will not activate the jack switch and will not open the insert loop in the circuit (thereby allowing the channel signal to continue on its merry way through the mixer).

This allows you to tap out the channel or bus signal at that point in the circuit without interrupting normal operation.

If you push the ¼" TS plug in to the second click, you will open the jack switch and create a direct out, which does interrupt the signal in that channel. See Figure E.



NOTE: Do not overload or short-circuit the signal you are tapping from the mixer. That will affect the internal signal.

MACKIE STEREO INPUTS AND RETURNS: Mono, Stereo, Whatever

Stereo line inputs and stereo AUX returns are a fine example of the Mackie philosophy (which we just made up) of Maximum Flexibility with Minimum Headache. The inputs and returns will automatically be mono or stereo, depending upon how you use the jacks. Here's how it works:

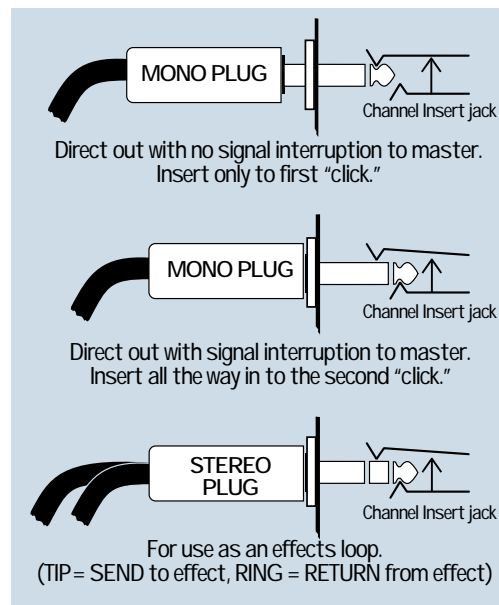

Figure E

A mono signal should be patched into the input or return jack labeled Left (MONO). The signal will be routed to both the left and right sides of the return circuit, and will show up in the center of the stereo pair of buses it's assigned to, or it can be "panned" with the Balance control.

A stereo signal, having two plugs, should be patched into the LEFT (MONO) and the RIGHT input or return jacks. A jack switch in the RIGHT jack will disable the mono function, and the signals will show up in stereo.

A mono signal connected to the RIGHT jack will show up in the right bus only. You probably will only want to use this sophisticated effect for special occasions (weddings, bar mitzvahs, Rush Limbaugh's birthday party, etc.)

MULTS AND "Y"s

A mult or "Y" connector allows you to route one output to two or more inputs by simply providing parallel wiring connections. You can make "Y"s and mults for the outputs of both unbalanced and balanced circuits.



Remember: Only mult or "Y" an output into several inputs. If you need to combine several outputs into one input, you must use a mixer, not a mult or a "Y."

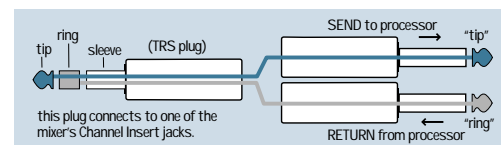

Figure F

APPENDIX C: BALANCED LINES, PHANTOM POWERING, GROUNDING AND OTHER ARCAINE MYSTERIES

Balanced Lines

Balanced lines offer increased immunity to external noise (specifically, hum and buzz). Because a balanced system is able to minimize noise, it is the preferred interconnect method, especially in cases where very long lengths of cable are being used. A long unbalanced cable carries with it more opportunity for noise to get into a system — having balanced inputs means very little noise will enter the system via snakes and other cables that typically must run a long length. But regardless of length, balanced lines are best.

Phantom Powering and Microphones

History

Condenser (capacitor) microphones differ from dynamic and ribbon microphones because they are not self-generating. That is, they cannot generate electricity in response to an impinging sound wave. A condenser microphone modifies an external source of electricity to reflect the effects of a sound wave striking its diaphragm.

Dynamic and ribbon microphones use magnetism to generate electricity in response to a sound wave: they are self-generating. Furthermore, both of these types of microphones are inherently low-impedance devices. It is possible to connect a dynamic microphone element directly to a balanced, low-impedance mixer input. Many commercially made dynamic microphones do just that.

On the other hand, a condenser microphone is an inherently high-impedance device. How high? Verrrrrry high. On the order of a billion ohms (1 Gigaohm). This is high enough that the inherent capacitance of a foot of shielded cable would audibly reduce the output of the microphone. All condenser microphones have an impedance converter, in the form of a vacuum tube or field-effect transistor (FET), built into the microphone and located extremely close to the microphone element. The impedance converter and the microphone element itself require an external power source.¹

¹ To be strictly correct, electret condenser microphones are a bit different, as the microphone element does not require a power source for operation (it is more or less permanently self-polarized). Regardless, the impedance converter still requires an external source of power.

What is it, exactly?

The obvious external power source for any modern microphone is a battery. About the only electronic advantage that a battery has is that its output is pure DC. The only other advantage is to the battery company — you have to keep on buying them.

Tube microphones require several different voltages for operation. This invariably means a multi-conductor cable and non-standard (not XLR) connectors. A tube microphone will always have an associated external power supply.

In the late 1960's, Neumann (you know, the folks that brought you the U47 and U87 microphones) converted its microphones to solid-state, adopting a system of remote powering that they called, and trademarked, Phantom Powering. Because of the trademark, some manufacturers use terms like Simplex Powering, etc. Over the years, the trademark has become genericized and now refers to any device that is powered according to DIN standard 45 596 (or maybe it's DIN standard 45 595, we're not exactly sure...).

So, why "Phantom" Powering? Because (like the Phantom in the old comic strip) it's there when you need it, and invisible when you don't. This technology is not new; it actually predates rocket science. Like many other things in audio, it was brought to you by the telephone company, who used it to get an extra circuit from a pair of wires. In effect, so does your phantom powered microphone.

What is important is: phantom powering is a compatible system. Your dynamic/ribbon microphones as well as your condenser microphones work side-by-side, from the same microphone inputs, without further thought on your part.

Technically speaking, phantom powering refers to a system where the audio signal is applied to the balanced line in differential-mode, and the DC power is applied common-mode. The audio travels via pins 2 and 3, the power travels between pins 2 and 3 simultaneously, and pin 1 is the ground for both audio and power.

PHANTOM POWER DO & DON'T CHART	
DO	DON'T
If you are plugging in a condenser microphone, do verify that your microphone can be phantom powered.	Worry about your other microphones as long as their output is balanced and floating.
Ensure that the microphone's output is low impedance, balanced and floating. This is especially important for vintage ribbon microphones like the RCA 44BX and 77DX.	Connect microphones or devices that do not conform to the DIN 45 596 standard.
Mute the sound system when turning the phantom power on or off, or when connecting or disconnecting microphones. If you forget, the resulting loud, nasty POP may be your last.	Don't connect A-B or T-system microphones (another remote powering system) without suitable adaptors.

Microphones that do not require power simply ignore the DC present between pin 2/pin 3 and pin 1. If you measure with a voltmeter between pin 2 and pin 3, you will read 0 Volts DC. This is what your dynamic microphone sees. Measuring between pin 2 and pin 1, or between pin 3 and pin 1, you will read the phantom power voltage, usually 48V, without a microphone connected. The dynamic microphone, as well as your balanced mixer input, ignores this voltage.

Lately, the term phantom power has been perverted to refer to any remote powering system. In the strict sense of the DIN standard, this is not true. Furthermore, microphones or transducers that claim to use this system are not compatible with the DIN standard and will almost certainly be damaged if connected into such a system. Fortunately, these systems use tip-ring-sleeve phone plugs or miniature XLR connectors and they are usually associated with instrument pickup applications².

Phantom powering is defined in DIN standard 45 596 or IEC standard 268-15A. Your Mackie Designs mixer conforms to this standard.

What works?

To be compatible in a phantom powered system, a device (microphone, preamp with a microphone-style output, or direct box) must have a balanced and floating, low-impedance output. This includes all microphones commonly used for sound reinforcement and

recording, such as the Shure SM58, SM57, Electro-Voice RE-15, RE-16, RE-20, ND series, Beyer M160, M500, AKG D224, D12, D112, and *many* others.

If you are fortunate enough to own any tube condenser microphones, such as the AKG C12, Neumann U47 or U67, these microphones may be connected in a phantom powered system and will operate without regard to the presence or absence of phantom power. They will always require their external power supply (which must be plugged in and turned on).

What doesn't work?

The list is short:

1. Microphones with unbalanced outputs.
2. Microphones with grounded center-tapped outputs. Many old ribbon microphones were supplied connected this way. Have a technician lift the ground from the center tap.
3. High-impedance microphones.
4. Microphones that exhibit leakage between pin 2 or pin 3 and pin 1. These microphones will sputter and crackle when phantom power is applied and will work fine when you turn off the phantom power. Get the microphone repaired.

² There is another remote powering system called A-B or T-system powering. It uses pins 2 and 3 to carry both power and audio. It is not compatible with dynamic microphones or phantom-powered microphones.

Do's and Don'ts of Fixed Installations

If you install sound systems into fixed installations, there are a number of things that you can do to make your life easier and that increase the likelihood of the sound system operating in a predictable manner. Even if you don't do fixed installations, these are good practices for any sound system, installed.

1. Do use foil-shielded snake cable for long cable runs. Carefully terminate each end, minimizing the amount of shielding removed. Protect the exposed foil shield with shrink sleeving or PVC sleeving. Prevent adjacent shields from contacting each other (electrically). Use insulating sleeving on the drain wire (the one that connects to pin 1) to prevent it from contacting the connector shell.
2. Don't connect the XLR connector shell to pin 1 of the XLR connector (unless necessary for RFI shielding). Doing so is an invitation for a ground loop to come visiting.
3. Do ensure that your speaker lines and AC power lines are physically separated from your microphone lines.
4. If you use floor pockets, use separate pockets for inputs and speakers, or put the connectors on opposite sides of the box so that they may be shielded separately.
5. If your speaker lines run in the open, they should be twisted pairs, at least 6 twists per foot. Otherwise, run the speaker lines in their own conduit. (Of course, conduit is not too practical for portable systems, heh-heh.)
6. Minimize the distance between the power amplifiers and the speakers.
7. Use heavy gauge, stranded wire for speaker lines. Ideally, the wire resistance should be less than 6% (0.5dB power loss) of the load impedance. Remember that the actual run is twice as long as the physical length of the run. See below.
8. Ensure that the electrician uses the star-ground system for the safety grounds in your electrical system. All of the audio system grounds should terminate at the same physical point. No other grounds may come in contact with this ground system.
9. Ensure that the AC power feeds are connected to the same transformer, and ideally, the same circuit breaker.
10. Walk outside – look at the horizon, see any radio towers? Locate potential sources of RF interference and plan for them before you begin construction. Know the frequency, transmitter power, etc. You can get this information by calling the station. Remember that many broadcast stations change antenna coverage pattern and transmitter power at night.
11. Don't use hardware-store light dimmers.
12. Don't allow for anything other than microphone inputs at stage/altar locations. Supplying line inputs at these locations is an invitation for misuse. Make all sources look like microphones to the console.
13. Balance (or at least impedance balance) all connections that are remote from the console's immediate location.
14. If you bridge an amplifier, don't use 1/4" phone plugs for speaker connectors.

Grounding

Grounding exists in your audio system for two reasons: product safety and noise reduction. The third wire on the power cord exists for product safety. It provides a low-resistance path back to the electrical service to protect the users of the product from electrical shock. Hopefully, the resistance to ground through the safety ground (third wire) is lower than that through the user/operator to ground. If you remove this connection (by breaking or cutting the pin off, or by using a 'ground cheater'), this alternate ground path ceases to exist, which is a safety hazard.

The metal chassis of the product, the ground connections provided by the various connectors, and the shields within your connecting cables provide a low potential point for noise signals. The goal is to provide a lower impedance path to ground for noise signals than through the signal wiring. Doing so helps minimize hum, buzz, and other extraneous non-audio signals.

Maximum wire run for 0.5dB power loss in feet

wire gauge	res. per 1000 ft.	2 Ω	4 Ω	8 Ω
10	1.00	60	120	240
12	1.59	40	75	150
14	2.5	24	48	95
16	4.02	15	30	60

Many “authorities” tell you that shields should only be connected at one end. Sometimes this can be true, but for most (99%) audio systems, it is unnecessary. If you do everything else correctly, you should be able to connect every component of your audio system using standard, off-the-shelf connecting cables that are available at any music store.

Here are some guidelines:

1. All return lines to the stage should be balanced. At a minimum, they should be impedance balanced. Remember that you can balance a line by inserting a piece of equipment inline that has a balanced output.
2. Run your own AC power wiring from the stage for the mixer and related equipment. Don't use the “conveniently located” receptacle thoughtfully provided by the management for your use. You have no idea how it's wired or grounded.
3. Carry an outlet tester, available at any well-stocked hardware store. Use it to tell you if the outlet you're about to plug into is wired correctly. Consider it cheap insurance.
4. If you carry enough equipment that you need to wire directly into the electrical service, then use a voltmeter to ensure that the line voltage is correct, then use the outlet tester mentioned in #3, above. Do this before you connect any of your audio equipment. Chances are that your 120V gear won't be too happy if it sees 220V for any length of time.
5. Cables that are too long are less likely to pick up hum if you uncoil them in their entirety, and then find a place to stow the excess. Leaving the excess coiled only helps the cable pick up hum more efficiently.
6. Don't run unbalanced lines to or from the stage. It's not the impedance, it's the fact that they're unbalanced. It's a good idea to use a direct box to make the unbalanced source look like a microphone.
7. For really extreme cases, you may need to insert 1:1 or isolation transformers into each return line from the front-of-house location to your amp racks.

8. Don't cut the third pin off of the power cord. Carry some ground-lifter adapters and use them only when you have to plug into an ancient two-wire outlet.
9. If you bundle your cables together, don't bundle AC wiring and audio wiring together. Bundle them separately.
10. If your sound system insists on humming, you may need to teach it the words.

FREE T-SHIRT OFFER

We love to hear what folks have created using our mixers. If you use your 1402-VLZ PRO to track and/or mix a CD that is commercially released, we'll trade you a disc for a genuine Mackie T-Shirt! By “commercially released,” we mean “offered for sale,” even if it's just being sold out the back door of a local Karaoke joint. No hand-lettered covers, please and thank you. Furthermore, if you send us an interesting story or photograph about your production, we might just use it somewhere! To get your genuine 100% cotton Mackie Celebrity T-shirt, send your CD (and optional story or photo) to:

Mackie Designs
FREE T-SHIRT OFFER
attn: Communications Department
16220 Wood-Red Rd. NE
Woodinville, WA 98072

(Roll credits please) Manual written by Jeff Gilbert, based on a short story by Ron Koliha, now a major Broadway Musical. Manual then defaced with proofreading pens in the hands of Mackie's legendary Tech Support staff. Manual composed on a rinky-dink PC using a low-budget word processor, then converted to this amazing piece of work using a 13-story 1000 gigawhopper Macintosh operated by Mackie's notorious Advertising staff (most notably Becky Priebe). Please, feel free to let us know if you find an error or stumble over a confusing paragraph. Thank you for reading the entire manual (we know you have, or you wouldn't be here).

Mackie, the “Running Man” figure, VLZ and XDR are trademarks or registered trademarks of Mackie Designs Inc. Other brand names mentioned are trademarks or registered trademarks of their respective holders and are hereby acknowledged.

© 1999 Mackie Designs Inc.
All rights reserved

MACKIE

1402-VLZ PRO

14-CHANNEL MIC/LINE MIXER

WITH PREMIUM XDR™ MIC PREAMPLIFIERS

Session: _____

Date: _____

MIC 1 XDR MIC PREAMP		LINE IN 1 BAL UNBAL	
MIC 2 XDR MIC PREAMP		LINE IN 2 BAL UNBAL	
MIC 3 XDR MIC PREAMP		LINE IN 3 BAL UNBAL	
MIC 4 XDR MIC PREAMP		LINE IN 4 BAL UNBAL	
MIC 5 XDR MIC PREAMP		LINE IN 5 BAL UNBAL	
MIC 6 XDR MIC PREAMP		LINE IN 6 BAL UNBAL	

MONO	L	BAL UNBAL	R	LEVEL	LINE IN 7-8
MONO	L	BAL UNBAL	R	LEVEL	LINE IN 9-10
MONO	L	BAL UNBAL	R	LEVEL	LINE IN 11-12
MONO	L	BAL UNBAL	R	LEVEL	LINE IN 13-14

LEFT/MONO	RIGHT	ALL BAL/UNBAL	1	2
STEREO AUX RETURN	AUX SEND	TAPE INPUT	L	R
BAL/UNBAL	L	R	TAPE OUTPUT	L
MAIN OUT	L	R	TAPE OUTPUT	R

NOTES:

AUX 1 MIX/EFX	2 EFX	EQ HI 12kHz MID 2.3kHz LOW 80Hz	PAN L R	1 MUTE ALT 3-4	SOLO
AUX 2 MIX/EFX	2 EFX	EQ HI 12kHz MID 2.3kHz LOW 80Hz	PAN L R	2 MUTE ALT 3-4	SOLO
AUX 3 MIX/EFX	2 EFX	EQ HI 12kHz MID 2.3kHz LOW 80Hz	PAN L R	3 MUTE ALT 3-4	SOLO
AUX 4 MIX/EFX	2 EFX	EQ HI 12kHz MID 2.3kHz LOW 80Hz	PAN L R	4 MUTE ALT 3-4	SOLO
AUX 5 MIX/EFX	2 EFX	EQ HI 12kHz MID 2.3kHz LOW 80Hz	PAN L R	5 MUTE ALT 3-4	SOLO
AUX 6 MIX/EFX	2 EFX	EQ HI 12kHz MID 2.3kHz LOW 80Hz	PAN L R	6 MUTE ALT 3-4	SOLO
AUX 7-8 MIX/EFX	2 EFX	EQ HI 12kHz MID 2.3kHz LOW 80Hz	PAN L R	7-8 MUTE ALT 3-4	SOLO
AUX 9-10 MIX/EFX	2 EFX	EQ HI 12kHz MID 2.3kHz LOW 80Hz	PAN L R	9-10 MUTE ALT 3-4	SOLO
AUX 11-12 MIX/EFX	2 EFX	EQ HI 12kHz MID 2.3kHz LOW 80Hz	PAN L R	11-12 MUTE ALT 3-4	SOLO
AUX 13-14 MIX/EFX	2 EFX	EQ HI 12kHz MID 2.3kHz LOW 80Hz	PAN L R	13-14 MUTE ALT 3-4	SOLO

AUX 1 MASTER

RE POST SELECT

AUX RETURN

CR/SOURCE

LEFT

RIGHT

MAIN MIX

ALT 3-4

TAPE

ASSIGN TO MAIN MIX

SOLO

PHANTOM POWER

SOLO LIGHT

LEVEL SET

SOLO LIGHT

CTL ROOM/SUBMIX

MAIN MIX