

**SONY**

3-758-408-23(1)



# ***FM Stereo/FM-AM Receiver***

---

Operating Instructions

***STR-D615  
STR-D515***

# WARNING

## WARNING

To prevent fire or shock hazard, do not expose the unit to rain or moisture.

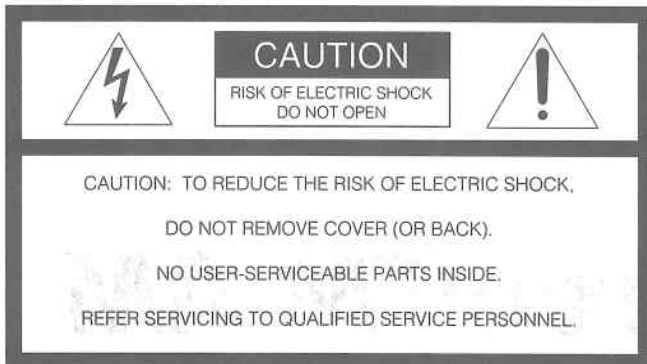

This symbol is intended to alert the user to the presence of uninsulated "dangerous voltage" within the product's enclosure that may be of sufficient magnitude to constitute a risk of electric shock to persons.



This symbol is intended to alert the user to the presence of important operating and maintenance (servicing) instructions in the literature accompanying the appliance.

### Note to CATV system installer

This reminder is provided to call the CATV system installer's attention to Article 820-40 of the NEC that provides guidelines for proper grounding and, in particular, specifies that the cable ground shall be connected to the grounding system of the building, as close to the point of cable entry as practical.

### Owner's Record

The model number is located on the rear exterior and serial number is on the rear. Record the serial number in the space provided below. Refer to these numbers whenever you call upon your Sony dealer regarding this product.

Model No. STR-D615      Serial No. \_\_\_\_\_  
Model No. STR-D515      Serial No. \_\_\_\_\_

### INFORMATION

This equipment has been tested and found to comply with the limits for a Class B digital device, pursuant to Part 15 of the FCC Rules. These limits are designed to provide reasonable protection against harmful interference in a residential installation. This equipment generates, uses, and can radiate radio frequency energy and, if not installed and used in accordance with the instructions, may cause harmful interference to radio communications. However, there is no guarantee that interference will not occur in a particular installation. If this equipment does cause harmful interference to radio or television reception, which can be determined by turning the equipment off and on, the user is encouraged to try to correct the interference by one or more of the following measures:

- Reorient or relocate the receiving antenna.
- Increase the separation between the equipment and receiver.
- Connect the equipment into an outlet on a circuit different from that to which the receiver is connected.
- Consult the dealer or an experienced radio/TV technician for help.

### CAUTION

You are cautioned that any change or modifications not expressly approved in this manual could void your authority to operate this equipment.

### NOTICE FOR THE CUSTOMERS IN THE UNITED KINGDOM

A moulded plug complying with BS 1363 is fitted to this equipment for your safety and convenience.

Should the fuse in the plug supplied need to be replaced, a 5 AMP fuse approved by ASTA or BSI to BS 1362, (i.e. marked with ⚡ or ⚡ mark) must be used.

If the plug supplied with this equipment has a detachable fuse cover, be sure to attach the fuse cover after you change the fuse. Never use the plug without the fuse cover. If you should lose the fuse cover, please contact your nearest Sony service station.

### IMPORTANT

If the plug supplied is not suitable for the socket outlets in your home, it should be cut off and an appropriate plug fitted in accordance with the following instructions.

The wires in this mains lead are coloured in accordance with the following code:

Blue: Neutral

Brown: Live

As the colours of the wires in the mains lead of this apparatus may not correspond with the coloured markings identifying the terminals in your plug, proceed as follows:

The wire which is coloured blue must be connected to the terminal which is marked with the letter N or coloured black.

The wire which is coloured brown must be connected to the terminal which is marked with the letter L or coloured red. Do not connect either wire to the earth terminal in the plug which is marked by the letter E or by the safety earth symbol  $\perp$  or coloured green or green and yellow.

### WARNING

To prevent shock hazard, do not insert the plug cut off from the mains lead into a socket outlet. This plug cannot be used and should be destroyed.

### For the customers in Canada

#### CAUTION :

TO PREVENT ELECTRIC SHOCK, DO NOT USE THIS POLARIZED AC PLUG WITH AN EXTENSION CORD, RECEPTACLE OR OTHER OUTLET UNLESS THE BLADES CAN BE FULLY INSERTED TO PREVENT BLADE EXPOSURE.

# Table of Contents

## Introduction

# Overview

### Introduction

Overview .....	3
Precautions .....	4

### Chapter 1 Getting Started

Unpacking .....	4
Checking the supplied accessories .....	4
Inserting the batteries into the remote commander .....	4
Hooking up the system .....	5
Notes on connections .....	5
Connecting equipment .....	5
Connecting the FM antenna .....	6
Connecting the antenna ground .....	6
Connecting the AM antenna .....	6
Connecting speaker systems .....	7
Connecting the AC power (Except U.K. model) .....	7

### Chapter 2 Basic Operations

Listening to/watching a program source .....	8
Selecting a program source .....	8
Selecting the speaker system .....	8
Adjusting the audio .....	8
Receiving FM/AM broadcasts .....	9
Tuning in a station directly Direct tuning .....	9
Automatic tuning .....	10
Presetting stations .....	10
Tuning in a preset station - Preset tuning .....	11
Remote controls .....	12
Using the remote .....	12
Changing the settings of the FUNCTION buttons .....	13

### Chapter 3 Advanced Operations

Recording an audio source .....	14
Recording .....	14
Recording a video source .....	14
Video tape editing .....	14
Obtaining the surround effect .....	15
Available types of effects .....	15
Selecting the surround mode .....	15
Placement of speakers and selecting the CENTER MODE for dolby surround sound .....	16
Adjusting the speaker volume .....	17
Adjusting the delay time of the rear speakers .....	18

### Chapter 4 Other Information

Troubleshooting guide .....	19
Specifications .....	21
Identifying the parts and controls .....	23
Front panel .....	23
Remote commander .....	Back cover

The STR-D615/D515 is an FM Stereo/FM-AM receiver and audio/video control center.

You can listen to various audio/video program sources with this unit.

### TV/video programs

- You can enjoy TV or CATV programs with FM simulcast.

### Tuner

- Precise tuning is ensured by a quartz-locked digital synthesizer.

### Surround sound system

- This unit incorporates all of 3 types of surround effect. **DOLBY\* PRO LOGIC** \*: This unit incorporates the Dolby Pro Logic Surround Decoder which has the same functions for playback as movie theaters and gives a theater-like experience in your listening room, naturally reproducing the audio sound field. The input balance of Dolby Surround program sources is automatically adjusted. Since STR-D615 provides the high power center amplifier, you can obtain the optimum center speaker output according to the power of the front speakers system. **HALL:** Surround provides reverberation effect that is produced in a large concert hall. **SIMULATED:** Surround gives the feeling of width and thickness to monaural sound of old movie program, etc.

\* Manufactured under license from Dolby Laboratories Licensing Corporation. Additionally licensed under one or more of the following patents: U.S. number 3,959,590; Canadian numbers 1,004,603 and 1,037,877. "DOLBY", "Pro Logic", and the double-D symbol are trademarks of Dolby Laboratories Licensing Corporation.

### Remote control

- The supplied remote commander allows you to remotely control this unit and the equipments connected to the unit.

# Precautions

## On safety

- For U.S.A. and Canadian models, operate the unit only on 120 V AC, 60 Hz.
- For U.K. model, operate the unit only on 240 V AC, 50/60 Hz.
- For Australian model, operate the unit only on 240 V AC, 50 Hz.
- Should any solid object or liquid fall into the cabinet, unplug the unit and have it checked by qualified personnel before operating it any further.
- Unplug the unit from the wall outlet if it is not to be used for an extended period of time. To disconnect the cord, pull it out by grasping the plug. Never pull the cord itself.
- One blade of the plug is wider than the other for the purpose of safety and will fit into the power outlet only one way. If you are unable to insert the plug fully into the outlet, contact your dealer. (not applicable to U.K. and Australian customers)
- AC power cord must be changed only at the qualified service shop.
- This unit is not disconnected from the AC power source as long as it is connected to the mains outlet, even if the unit itself has been turned off.

## On operation

Before making program source connections, be sure to turn the power switch off and unplug the unit.

**To prevent internal heat buildup in the unit,** place the unit in a location with adequate air circulation.

## Do not install the unit:

- near heat sources such as radiators or air ducts.
- in a place subject to direct sunlight, excessive dust, mechanical vibration or shock.

## Do not place anything on top of the cabinet.

The top ventilation holes must be unobstructed for the proper operation of the unit and to prolong the life of its components.

## On cleaning the cabinet

Clean the cabinet, panel and controls with a soft cloth lightly moistened with mild detergent solution. Do not use any type of abrasive pad, scouring powder, or solvent such as alcohol or benzine.

## For the customers in the U.S.A.

For detailed safety precautions, see the "IMPORTANT SAFEGUARDS" leaflet.

If you have any question or problem concerning your unit, please consult your nearest Sony dealer.

# Unpacking

## Do not throw away the carton and packing material!

It will be an ideal container when transporting the system for repair work, etc.

## Checking the Supplied Accessories

After unpacking, check that the following accessories are present.

- FM wire antenna ..... (1)
- AM loop antenna ..... (1)
- Remote commander ..... (1)
- Sony batteries SUM-3 (NS) ..... (2)

## Inserting the Batteries into the Remote Commander

Before operating remote commander, install the batteries as shown below.

### 1 Open the cover.

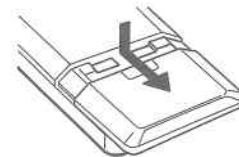

### 2 Insert two size-AA (R6) batteries with correct polarity.

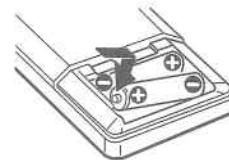

## To avoid damage caused by battery leakage and corrosion

When the commander will not be used for a long time, remove the batteries.

## Battery life

Normal operation can be expected about a half year using Sony SUM-3 (NS) (size-AA), and a year using Sony AM-3 (NW) (size-AA) alkaline batteries.

When the batteries are run down, the remote commander will not operate the unit. In this case, replace both batteries with new ones.

# Hooking Up the System

## Notes on Connections

At first, this section describes about the connection with the other equipments, the antenna connection, speaker connection and then the AC power connection.

- Do not connect the power cord to an AC outlet nor press the POWER switch before accomplishing all other connections.
- The cable connectors should be fully inserted into the jacks. Loose connection may cause hum and noise.
- Jacks and plugs of the connecting cord are color-coded as follows:  
 Red jacks and plugs: For the right channel of audio signals  
 White jacks and plugs: For the left channel of audio signals  
 Yellow jacks and plugs: For video signals

## Connecting Equipment

The numbers correspond to the following details on page 6 and 7.

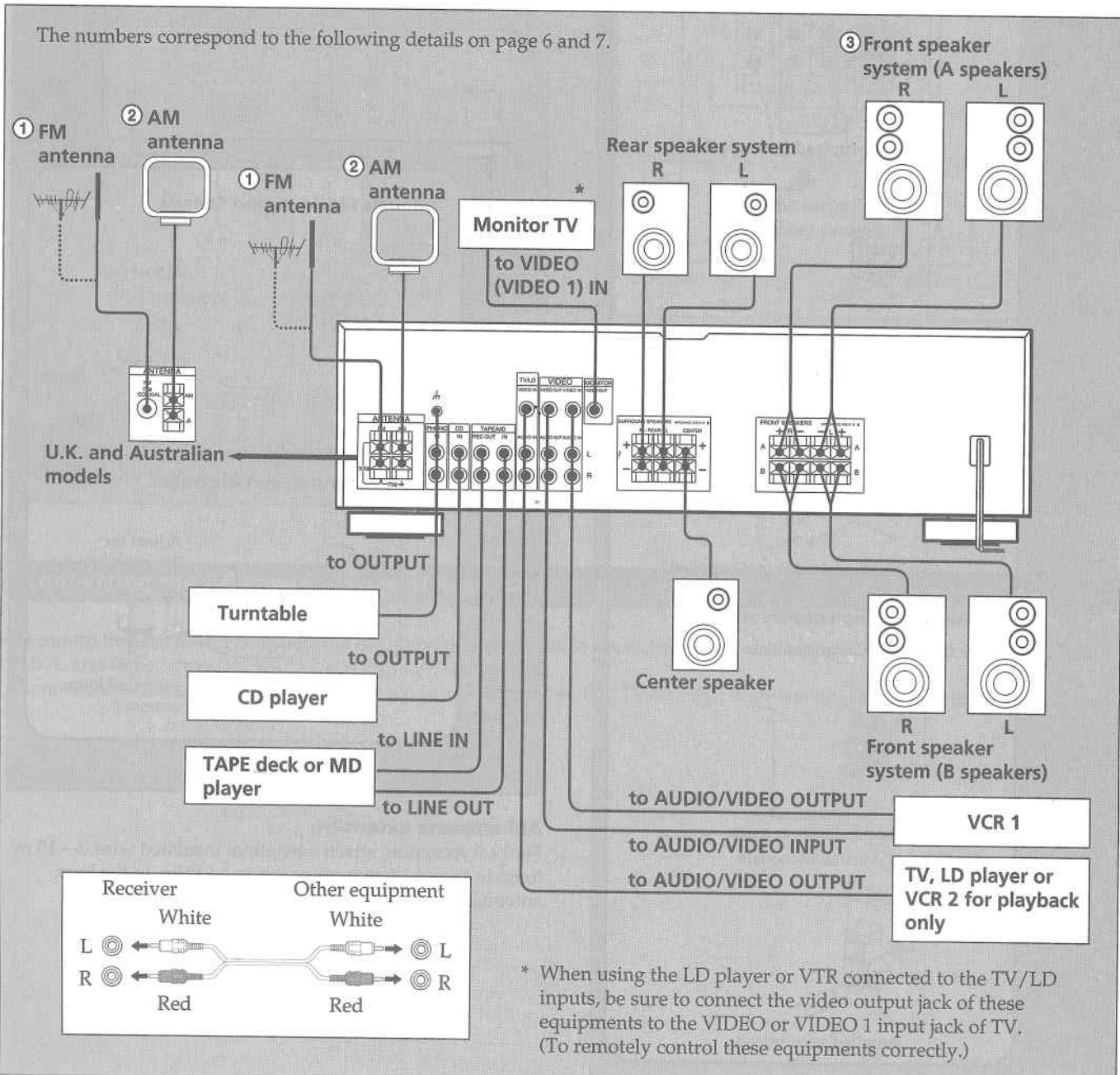



# Hooking Up the System

## 1 Connecting the FM Antenna

Though the wire antenna is supplied with this unit, the higher quality sound will be obtained with 75-ohm coaxial cable. (not supplied)

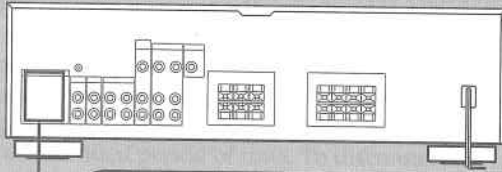

### For best reception:

For U.S.A. and Canada models

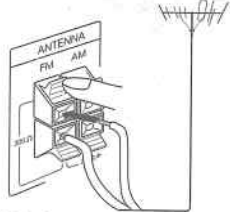

300-ohm twin-lead (not supplied)

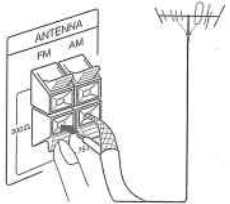

75-ohm coaxial cable (not supplied)

For U.K and Australian models

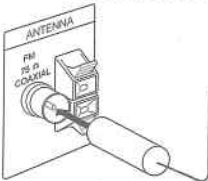

75-ohm coaxial cable (not supplied)

### When not using outdoor antenna:

For U.S.A. and Canada models

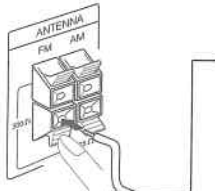

Supplied wire antenna

For U.K and Australian models

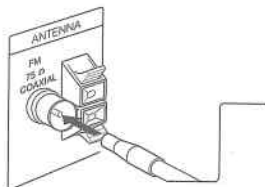

Supplied wire antenna

## Connecting the Antenna Ground

To prevent hum, connect the ground wire to the ANTENNA ground terminal (h).

When an outdoor antenna is installed, be sure to connect the ground wire for lightning protection.

## 2 Connecting the AM Antenna

The AM reception is adequate with the supplied AM loop antenna. However, the connection of insulated wire is also available for areas with difficult AM reception.

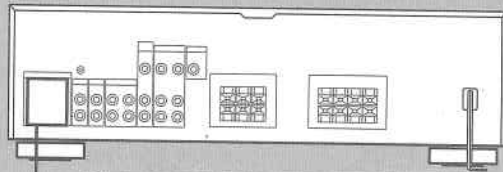

### Models for U.S.A. and Canada

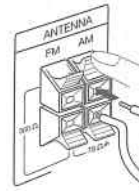

Adjust the direction.



Supplied loop antenna

### Models for U.K. and Australia



Adjust the direction.



Supplied loop antenna

### AM antenna extension

For best reception, attach a length of insulated wire (6 - 15 m long) to the AM screw connector in addition to the loop antenna.

### 3 Connecting Speaker Systems

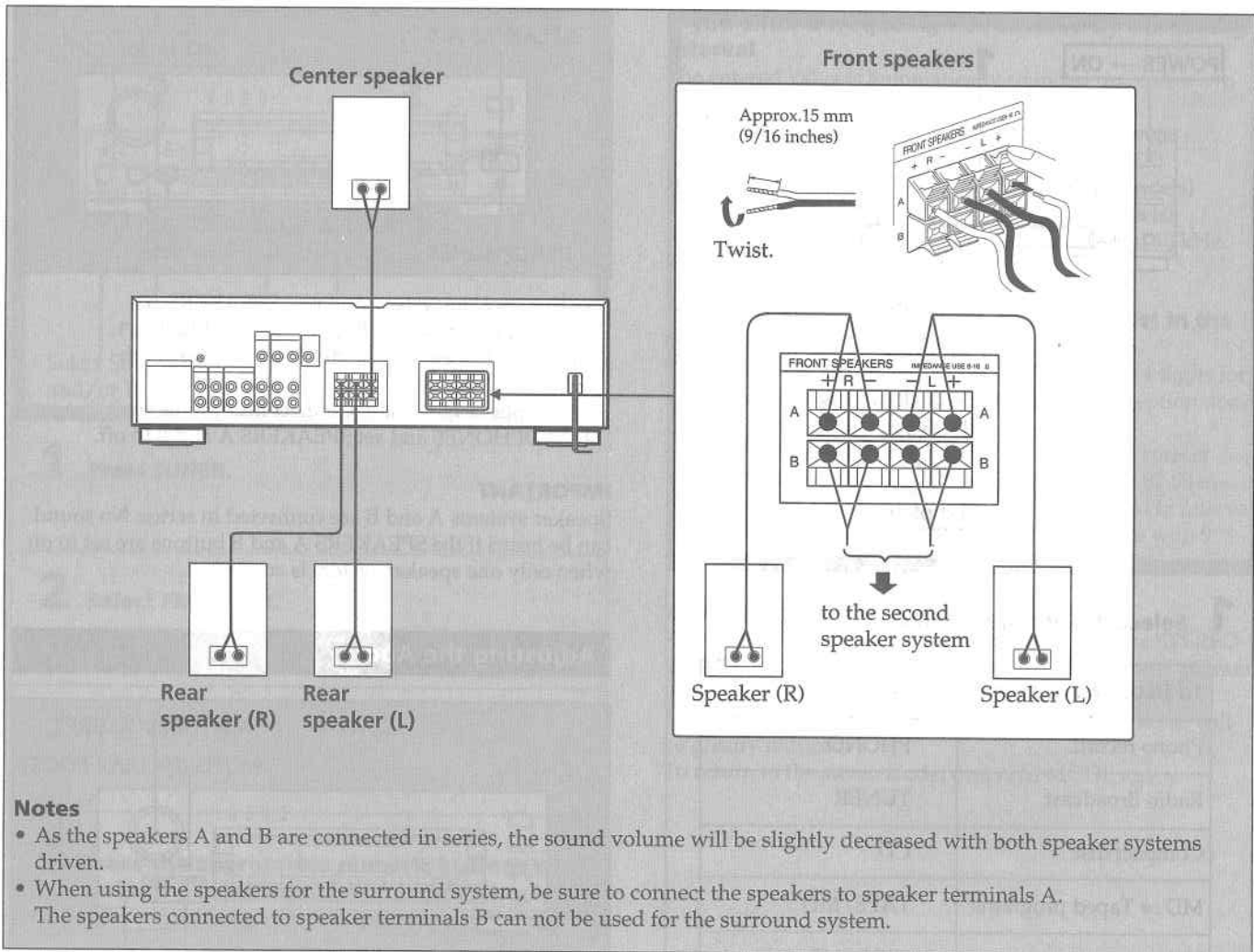

#### Notes

- As the speakers A and B are connected in series, the sound volume will be slightly decreased with both speaker systems driven.
- When using the speakers for the surround system, be sure to connect the speakers to speaker terminals A. The speakers connected to speaker terminals B can not be used for the surround system.

### Connecting the AC Power (Except U.K. Model)

Be careful that the power consumption of equipment connected to the outlet on the receiver does not exceed 120 watts for U.S.A. and Canada models or 100 watts for Australian model.

Do not connect electrical home appliance such as an electric iron, fan, TV, or other high-wattage equipment to the outlet.

# Listening to/Watching a Program Source

## Selecting a Program Source

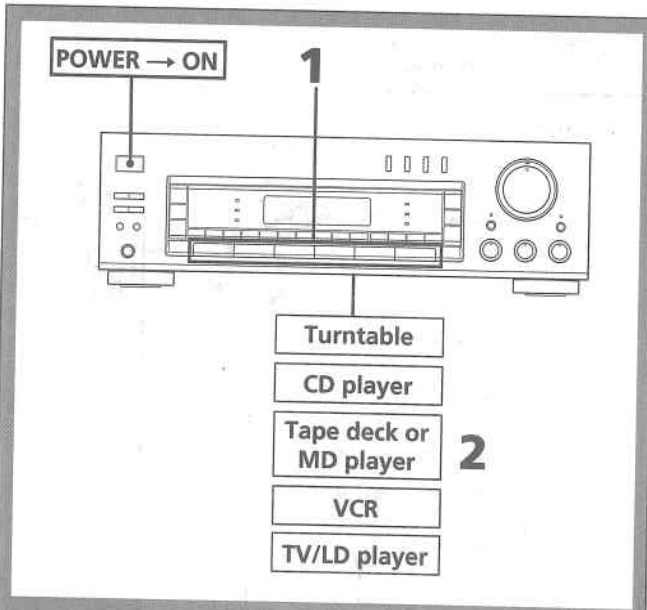

### 1 Select the program source.

To listen to or watch	Press
Phono record	PHONO
Radio Broadcast	TUNER
Compact disc	CD
MD or Taped programs	TAPE/MD
Video programs	VIDEO, TV/LD

If only pressing one of the FUNCTION buttons on the supplied remote commander, both the power of its operating equipment and the receiver are turned on. *(If unit is plugged into back of RCVR.) Power switch must be on*

### 2 Start the selected program.

## Selecting the Speaker System

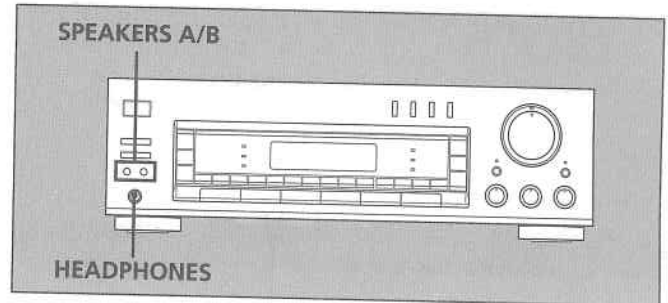

To drive speaker system A: Press SPEAKERS A.  
 To drive speaker system B: Press SPEAKERS B.  
 To drive both speaker systems A and B: Press both SPEAKERS A and B.  
 For headphones listening: Connect headphones to HEADPHONES and set SPEAKERS A and B to off.

### IMPORTANT

Speaker systems A and B are connected in series. No sound can be heard if the SPEAKERS A and B buttons are set to on when only one speaker system is connected.

## Adjusting the Audio

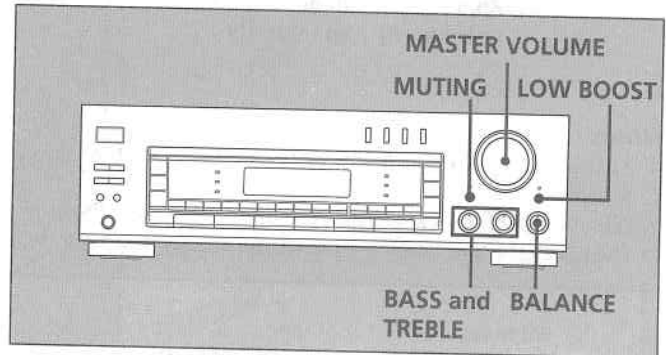

### Adjusting volume

Turn MASTER VOLUME.

### Reducing the sound to a low level temporarily (-20 dB attenuation)

Press MUTING and the indicator lights up. Press again to restore the same listening level as before and the indicator goes off.

### Adjusting Tone Quality

Adjust BASS or TREBLE for the optimum sound.

### Adjusting Left and Right Sound Balance

Adjust BALANCE to correct stereo imaging, when the speaker position is not symmetrical.

### Reinforcing the Bass

Press LOW BOOST and the indicator lights up. Press again to cancel the LOW BOOST effect and the indicator goes off.



# Receiving FM/AM Broadcasts

## Tuning in a Station Directly — Direct Tuning

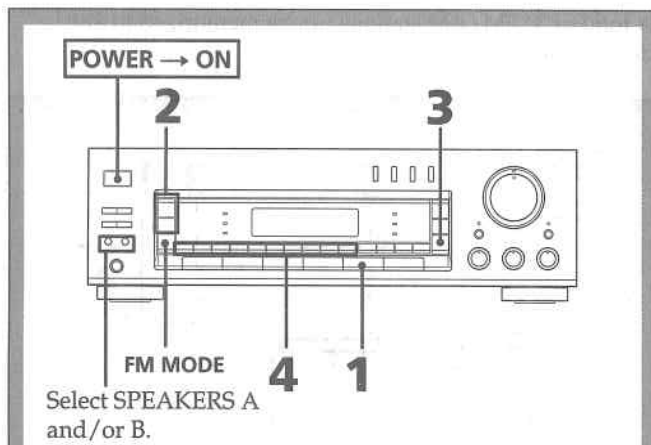

**1** Press **TUNER**.

**2** Select **FM** or **AM**.

**3** Press **DIRECT**.

**4** Press the appropriate numeric buttons to enter the frequency. (See examples below.) The entered frequency is displayed.

**Example 1:** FM 102.50 MHz

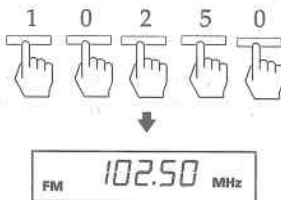

**Example 2:** AM 720 kHz

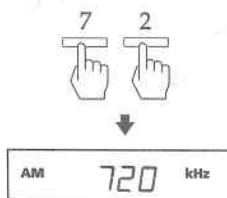

### Note on AM tuning

You need enter the last "0" for U.K. and Australian models.

### To correct the entered frequency

Repeat steps 3 to 4.

### If you enter a frequency not covered by the tuning interval

The entered value is automatically rounded up or down to the closest value covered by the tuning interval.

Tuning intervals for direct tuning are the followings:

FM: 50 kHz interval

AM: 10 kHz interval (for U.S.A. and Canadian models)

9 kHz interval (for U.K. and Australian models)

(To switch the tuning interval between 9 kHz and 10 kHz, see page 21.)

### When the entered frequency does not exist in the receivable frequency range

The entered digits (up to 5 digits for FM or up to 4 digits for AM) blink in the frequency display area, and reception does not take place.

If this occurs, press **DIRECT** again, and enter the correct frequency. The frequency range of the receiver is 87.50 to 108.0 MHz for FM, and 530 to 1710 kHz with 10 kHz interval (U.S.A. and Canadian models) or 531 to 1602 kHz with 9 kHz interval (U.K. and Australian models) for AM.

### When an FM stereo program is noisy

When the unit receives an FM stereo program, the **STEREO** indicator lights in the display window. If the stereo program is noisy, press **FM MODE** to change the mode over to **MONO**. This eliminates the stereo effect, but the noise will be greatly reduced.

To return to the stereo mode, press **FM MODE** again.

# Receiving FM/AM Broadcasts

## Automatic Tuning

When you do not know the frequency of the station, proceed as follows.

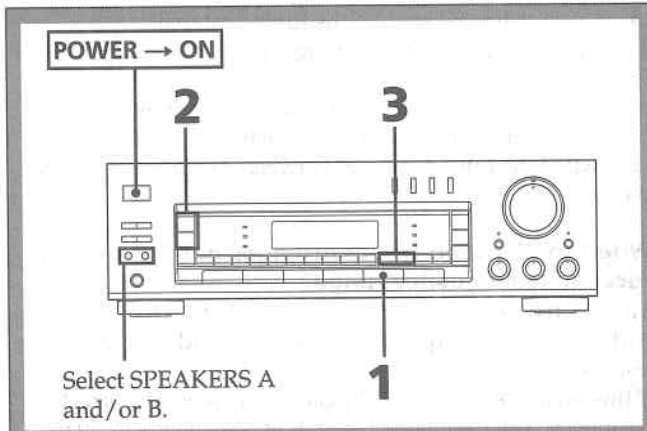

**1** Press **TUNER**.

**2** Select **FM or AM**.

**3** Press **TUNING + or -**.  
For a higher frequency, press **TUNING +**.  
For a lower frequency, press **TUNING -**.

When a station is received, automatic tuning stops automatically. To change the station, press + or - again.

### When sweeping does not stop at the desired station

The signal strength is weak. Tune in the station as described in "Tuning in a Station Directly" on page 9.

### Quickly tuning in a roughly known frequency

Proceed as the following example.  
Example: The station around AM 700 kHz.

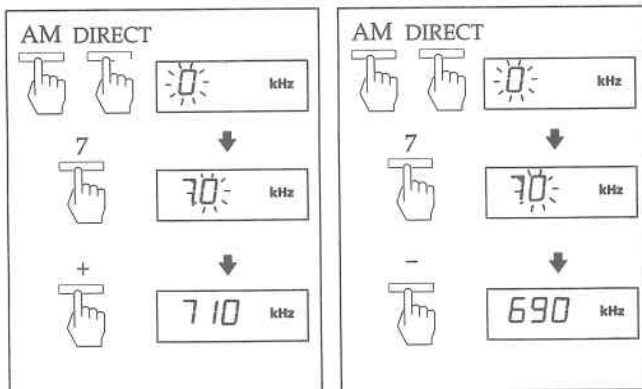

## Presetting Stations

A total of 30 FM/AM stations can be memorized in any desired sequence.

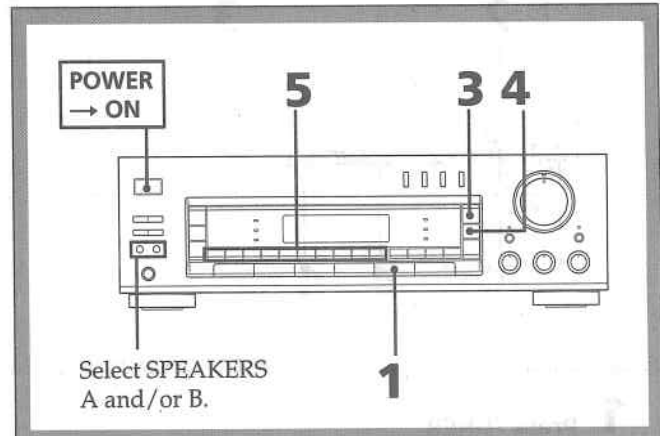

**1** Press **TUNER**.

**2** Tune in the desired station. (See "Automatic Tuning" or "Tuning in a Station Directly".)

**3** Press **MEMORY**.  
The **MEMORY** indicator appears for a few seconds.

**4** Press **SHIFT** to select the memory page (**A, B** or **C**).

Each time the button is pressed, **A, B** or **C** is selected cyclically.

**5** Press the desired numeric button (**1** to **0**) while the **MEMORY** indicator is displayed.

Repeat steps from 2 through 5 for presetting other desired stations.

### Use of memory pages

The memory pages (**A, B** and **C**) can be used to classify stations according to the music category, station band, etc.

### Replacing a preset station

Preset another station on the number of the station to be replaced. The previously preset station will be erased.

### IMPORTANT

The memorized station is maintained for approximately one month even if the power cord is disconnected from the AC power outlet. If they are erased, store the stations again.

## Tuning in a Preset Station - Preset Tuning

There are two ways to perform the preset tuning. In method A (direct tuning), select by designating the desired preset station number directly with the numeric button. In method B (scan tuning), select the preset station with the PRESET TUNING -/+ buttons.

### Method A: Direct tuning

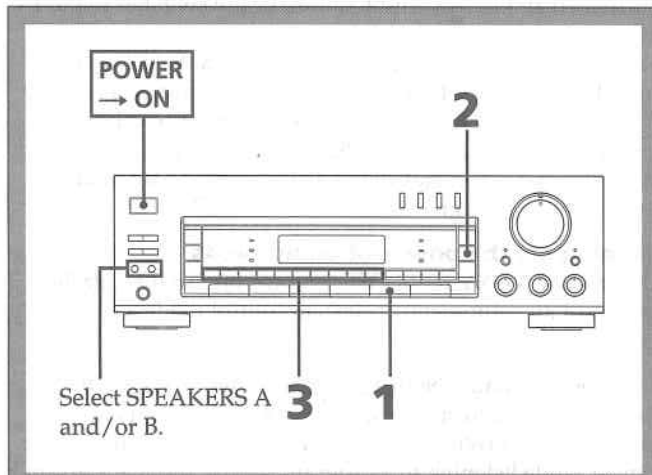

**1** Press **TUNER**.

**2** Press **SHIFT** to select the memory page (**A, B** or **C**).

Each time the button is pressed, A, B or C is selected cyclically.

**3** Press the numeric button.



### Method B: Scan tuning

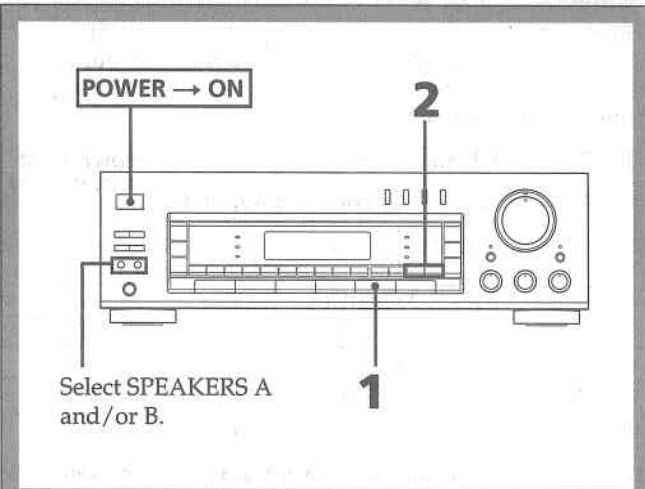

**1** Press **TUNER**.

**2** Press **PRESET TUNING -** or **+**.

For a higher frequency, press **PRESET TUNING +**.  
For a lower frequency, press **PRESET TUNING -**.

Each time you press + or -, the preset station of the next higher or lower number is tuned in.

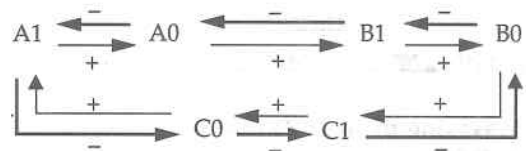

- If you keep pressing + or -, preset stations are successively tuned in. Release the button when the desired preset station is tuned in.

# Remote Controls

## Using the Remote

The remote lets you operate the connected components as well as the receiver. Press one of the FUNCTION buttons first to select the program source, then use the following buttons to operate each component.

The FUNCTION buttons are factory set in the following list.

FUNCTION to be pressed	Operating equipment
TUNER	Tuner
TAPE/MD	Tape deck
CD	CD player
TV/LD	TV
VIDEO	VCR (VTR 1 mode)
PHONO	(The receiver enters the PHONO mode)

This remote commander can control Sony stereo cassette deck having RMS function.

For more information on the availability of Sony stereo cassette deck with RMS capability, contact your nearest Sony dealer.

## Turning power of each equipment

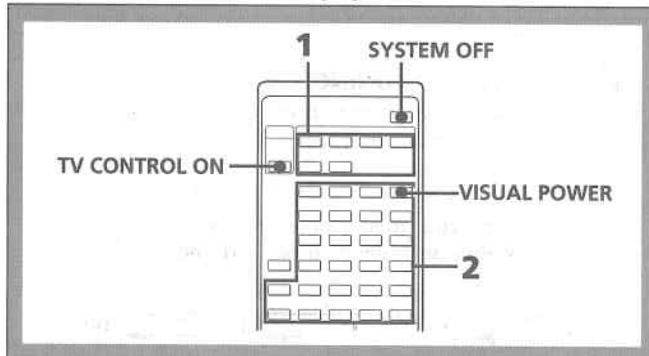

### 1 Press one of the SYSTEM CONTROL/FUNCTION button.

This unit and the corresponding equipment are turned on.

#### Only for Sony TV

When you press the VIDEO or TV/LD button, the power of the TV (VTR or LD player) is also turned on. When an LD player or VTR is selected, the input of TV switches to VIDEO, and when TV is selected, the input of TV switches to TV reception mode. (When you want to turn on the power of TV and switch the TV input simultaneously, keep pressing the button you have selected until its power is turned on, or press the button again after the TV is turned on.)

- If the TV input does not switch to the appropriate mode, switch the input signal with the TV/VIDEO button.

#### Note

To operate each equipment correctly, the function mode of the receiver should be same with that of the remote commander. So, be sure to press the desired FUNCTION button at first and then the operative button.

### 2 Operate the units with each buttons.

The buttons you can operate differ among function mode see "Operative Buttons".

## If you use TV most of time (Only for Sony TV)

You can make remote exclusively for the TV operations by pressing the TV CONTROL button. The power of TV is turned on and the TV input automatically switches to the TV reception mode.

(When you want to perform the turning on the power of TV and the switching of the TV input simultaneously, press the TV CONTROL ON button until its power is turned on, or press the button again after the TV is turned on.)

If the TV input does not switch to the appropriate mode, switch the input signal with the TV/VIDEO button.

## Turning off the power of equipments

By pressing the SYSTEM OFF button, you can turn off the power of all equipments in system control mode and the power of TV in TV control mode.

If the power cannot be turned off with the SYSTEM OFF button, you can turn off the power of each equipment with the VISUAL POWER button. When you want to turn off the power while listening to a program source, see "Back ground operation" on page 13.

## Operative buttons

For FM/AM tuner

To	Press
Select memory pages for preset tuning	SHIFT
Designate preset numbers	Numeric buttons
Scan and select preset stations	CH PRESET +/-

For tape deck/DAT/MD player

To	Press
Designate numbers	Numeric buttons
Designate number more than 10 (For tape deck and MD player)	>10
Fastforward	▶▶
Rewind	◀◀
Skip selections (For DAT and MD player)	▶▶, ◀◀
Pause play	
Start play	▶
Start reverse play (For tape deck)	◀
Select the tape running direction (For tape deck having RMS function)	RMS DIRECTION
Stop play	■
Clear the RMS program contents (For tape deck having RMS function)	RMS CLEAR
Start recording (Forward direction)	● + ▶
Start recording (Reverse direction for tape deck)	● + ◀
Program selections (For tape deck having RMS function)	RMS/START

### For CD player

To	Press
Designate numbers	Numeric buttons
Designate number more than 10	>10
Skip discs	D.SKIP
Search selections	▶▶, ◀◀
Skip selections	▶▶, ◀◀
Pause play	
Start play	▶
Stop play	■

### For TV/VTR/LD player

To	Press
Designate channel numbers of TV/VTR or selections of LD player	Numeric buttons
Designate selections of LD player more than 10	>10
Enter the selected TV/VTR channel	ENTER
Select TV to see TV programs and VIDEO to see videos.	TV/VIDEO
Select the output signal from the antenna terminal on the VTR: a TV signal or VTR program (For VTR)	ANT TV/VTR
Select a preset channel of TV or VTR	CH PRESET +/-
Fastforward (For VTR and LD player)	▶▶
Rewind (For VTR and LD player)	◀◀
Pause play (For VTR and LD player)	
Start play (For VTR and LD player)	▶
Stop play (For VTR and LD player)	■
Skip selections (For LD player)	▶▶, ◀◀
Start recording (For VTR)	● + ▶
Turn on the power of TV, VTR, or LD player	VISUAL POWER

### Back ground operation

You can temporarily operate other components while listening to/watching a program source. Press one of the numeric button\* in which a function is stored and an operation button at the same time while pressing BACK GROUND button. The operative buttons are VISUAL POWER, TV/VIDEO, CH PRESET +/-, ANT TV/VTR, D.SKIP, ▶, ◀, ■, ▶▶, ◀◀, ▶▶, ◀◀, ||, ●.

Example: To record the CD being played on tapes.

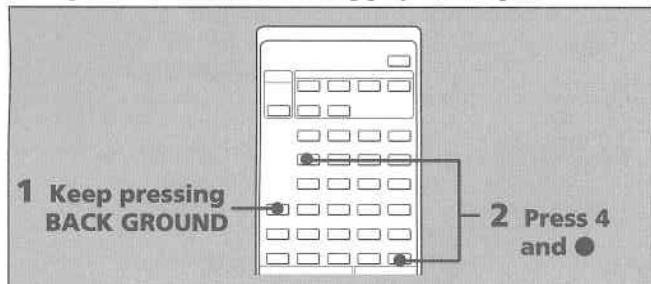

\* For stored functions in numeric buttons, see the table in "Changing the Settings of the FUNCTION buttons".

### Note

You can record only in the forward direction with back ground operation.

## Changing the Settings of the FUNCTION Buttons

You can replace the functions stored in the FUNCTION buttons.

### To change the settings of the SYSTEM CONTROL/ FUNCTION buttons

While pressing one of the FUNCTION button to be changed, press 1 to 0 button to select the desired function. After changing the setting of the FUNCTION button, the equipment can be operated with the FUNCTION button you have changed.

To return the function to the initial mode, perform the same operation above.

With the numeric buttons from 1 to 0, each function can be selected as described in the following table:

Numeric buttons	The function to be selected
1	CD player
2	DAT deck
3	MD player
4	DECK A
5	DECK B
6	LD player
7	VTR 1 (Remote control mode)
8	VTR 2 (Remote control mode)
9	VTR 3 (Remote control mode)
0	TV

Example: To change the CD FUNCTION button to the DAT function button.

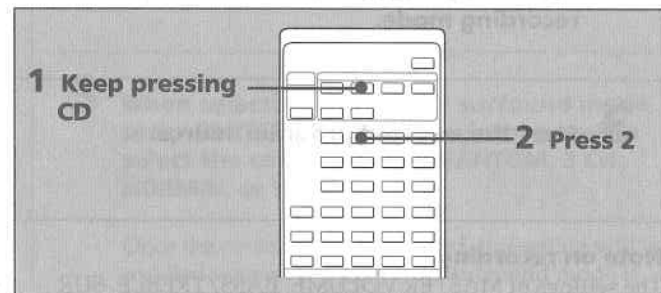

### Note

The settings of the TUNER button and the PHONO button can not be changed.



# Recording an Audio Source

## Recording

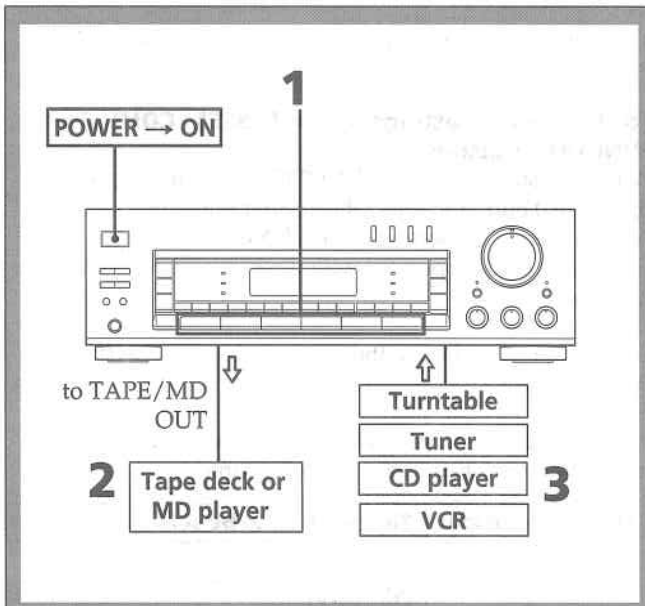

**1** Select the desired program source with the function selector.  
For an FM/AM broadcast, tune in the desired station.

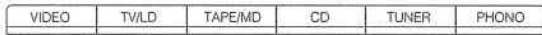

**2** Set the tape deck or MD player to the recording mode.

**3** Start the selected program source.

**Note on recording**

The settings of MASTER VOLUME, BASS/TREBLE, SUR (surround), LOW BOOST, BALANCE and MUTING do not have any effect on recording.

# Recording a Video Source

## Video tape editing

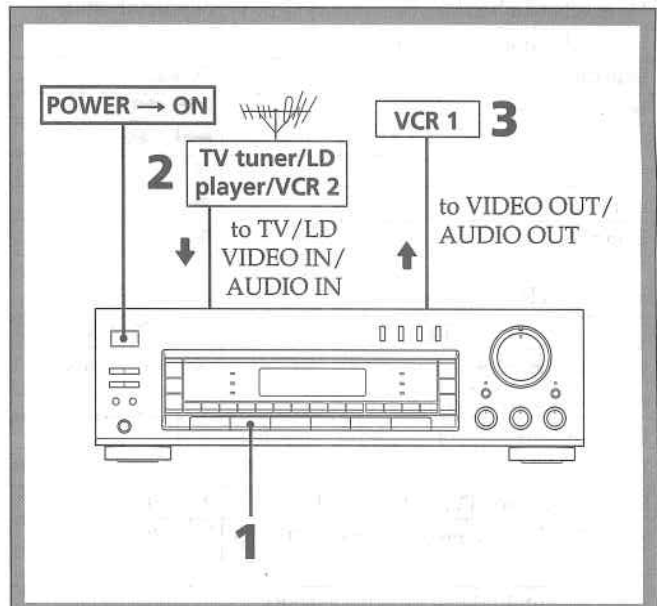

**1** Press TV/LD so that the TV/LD indicator lights up.

**2** Set TV tuner, LD player or VCR 2 to the playback mode.

**3** Set VCR 1 to the recording mode.

# Obtaining the Surround Effect

You can add 3 types of surround effects to the software. To enjoy the surround effects, two front and two rear speakers are necessary.

In the Dolby surround mode, the speaker operation mode can be selected according to your speaker configuration.

## Available Types of Surround Effects

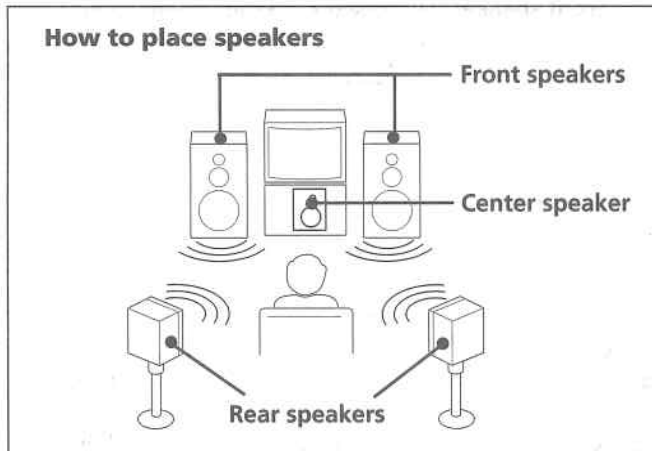

**HALL:** Provides reverberation effect that is produced in a concert hall.

**SIMULATED:** Gives a simulated stereo effect to monaural sound.

**DOLBY:** Expands sound just like listening to in a movie theater.

## Selecting the Surround Mode

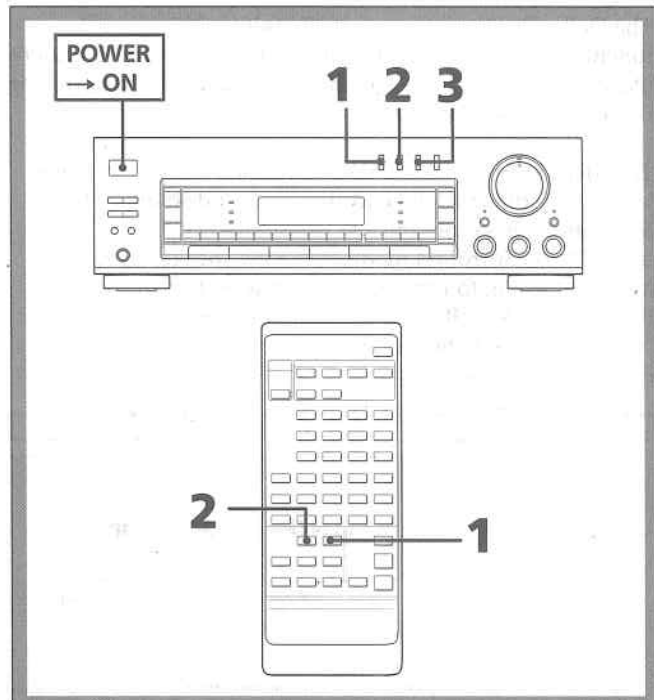

**1** Press SUR (SURROUND) ON/OFF to ON.

**2** Press SUR (SURROUND) MODE to select the surround mode.

Each time the button is pressed, the HALL, SIMULATED or DOLBY surround mode is selected cyclically and the corresponding indicator lights up

**3** When selecting the DOLBY surround mode, press CENTER MODE on the front panel to select the center mode (PHANTOM, 3 CH, NORMAL or WIDE).

Once the center mode is selected, the setting will be recalled whenever the DOLBY surround mode is selected unless you change the center mode. See "Placement of Speakers and Selecting the CENTER MODE for Dolby Surround Sound" on next page.

### Note

When you wish to enjoy the surround function, set the SPEAKERS A button or both A and B buttons to on. If only the SPEAKERS B button is set to on (that is, the SPEAKERS A button is set to off), the surround effect cannot be obtained.

# Obtaining the Surround Effect

## Placement of Speakers and Selecting the CENTER MODE for Dolby Surround Sound

The Dolby Pro Logic Surround Decoder has the same functions for playback as movie theaters and gives a theater-like experience in your listening room, naturally reproducing the audio sound field.

The STR-D615 and STR-D515 incorporate a decoder which reproduces the specially encoded surround sound of Dolby Surround video programs.

In the Dolby Surround mode, select the speaker operation mode according to your speaker configuration by pressing the CENTER MODE button. Each time the CENTER MODE button is pressed, the mode and the display are changed in the following order:

→ PHANTOM → 3 CH → NORMAL → WIDE →

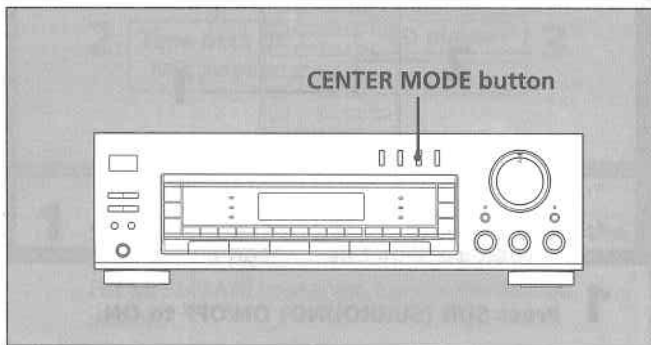

### PHANTOM mode

Select this mode when you play back a Dolby Surround program source without using a center speaker. The sound of the center channel is output from the front (L and R) speakers.

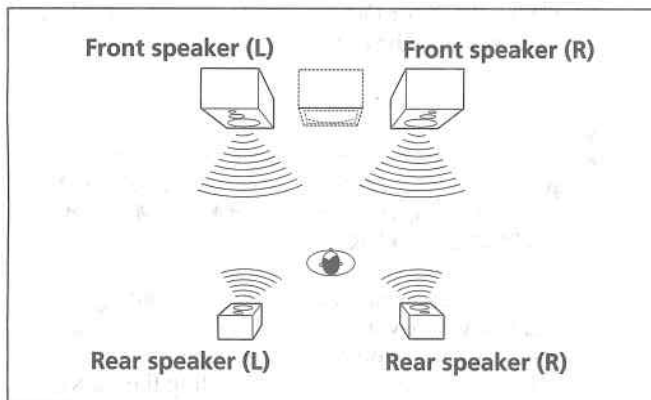

### 3 CH (3 Channel LOGIC) mode

Select this mode when you play back a Dolby Surround program source only with the front and center speakers. The sound of the rear channel is output from the front (L and R) speakers.

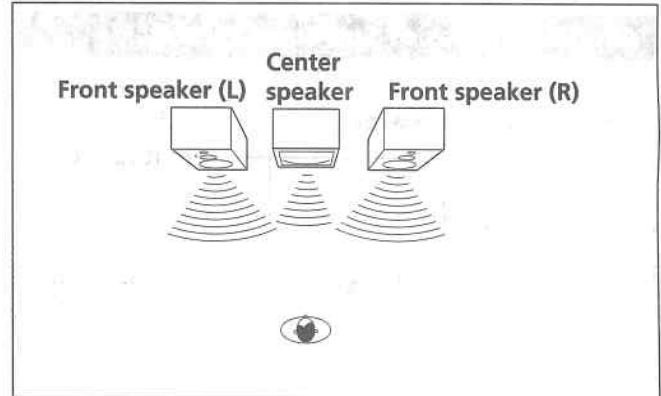

### NORMAL mode

Select this mode if you use small center speaker. The bass sound of the center channel is output from the front speakers, as a small speaker cannot produce enough bass.

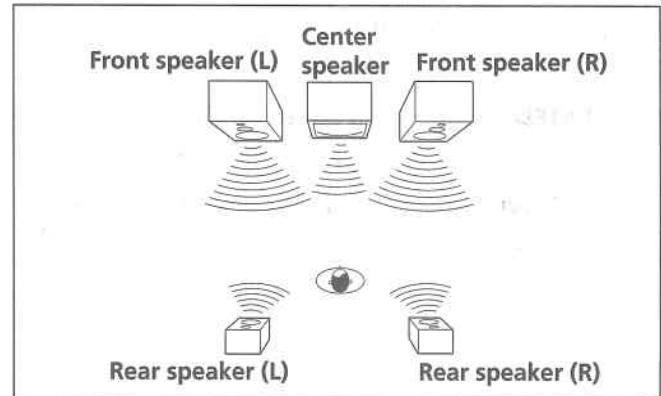

### WIDE mode

Select this mode if you use a medium to large center speaker.

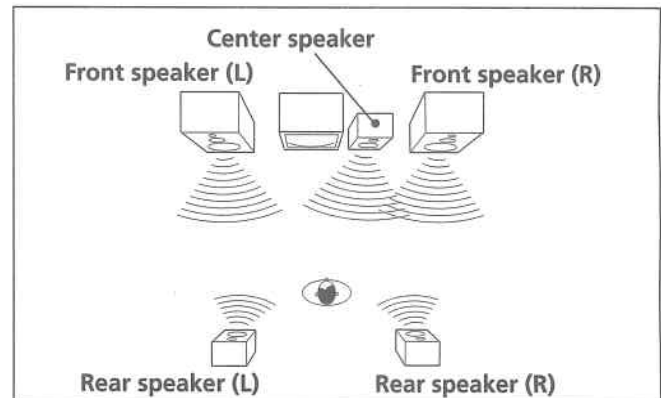

### Note

The Dolby Pro Logic Surround decoder is a system to decode the software carrying the  mark.

## Adjusting the Speaker Volume

To enjoy surround sound to the maximum on playing any program source, adjust the front, rear, and center (if connected) speakers to the same volume level. The level once adjusted can be used for all surround modes. You can adjust the volume level from your listening position by using the remote commander.

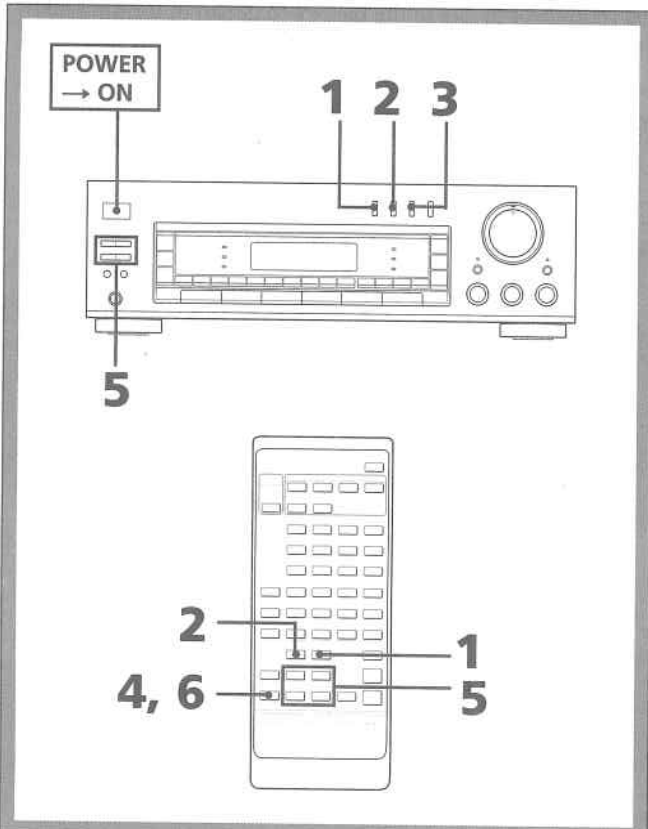

- 1** Press SUR (SURROUND) ON/OFF to ON.
- 2** Press SUR (SURROUND) MODE to select DOLBY.
- 3** Press CENTER MODE on the front panel to select the DOLBY surround mode (PHANTOM, 3CH.LOGIC, NORMAL or WIDE) according to your speaker system.
- 4** Press TEST TONE on the remote commander. The test tone is heard from each speaker sequentially.

- 5** Adjust the volume level so that the sound from each speaker will be the same level at the listening position.

### To adjust the level of rear speakers

Press REAR LEVEL - or + to adjust the level of rear speakers.

### To adjust the level of center speaker

Press CENTER LEVEL - or + to adjust the level of center speaker. (When adjusting the MASTER VOLUME on the receiver, all speakers are adjusted simultaneously.)

- 6** Press TEST TONE on the remote commander to turn off the test tone.

### Sequence of the test tone

In a system with a center speaker:

The test tone will be heard automatically from the front L, center, front R, and the rear speakers in succession.

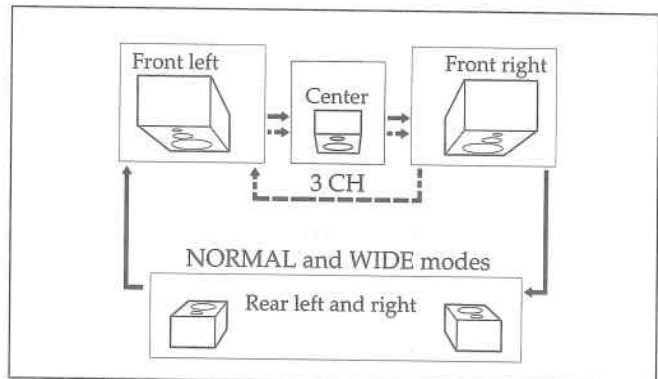

In a system without a center speaker:

The test tone will be heard automatically from the front left and right speakers and the rear speakers alternately.

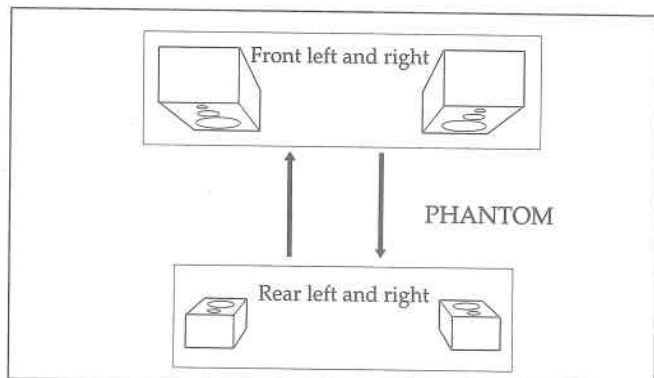

# Obtaining the Surround Effect

## Adjusting the Delay Time of the Rear Speakers

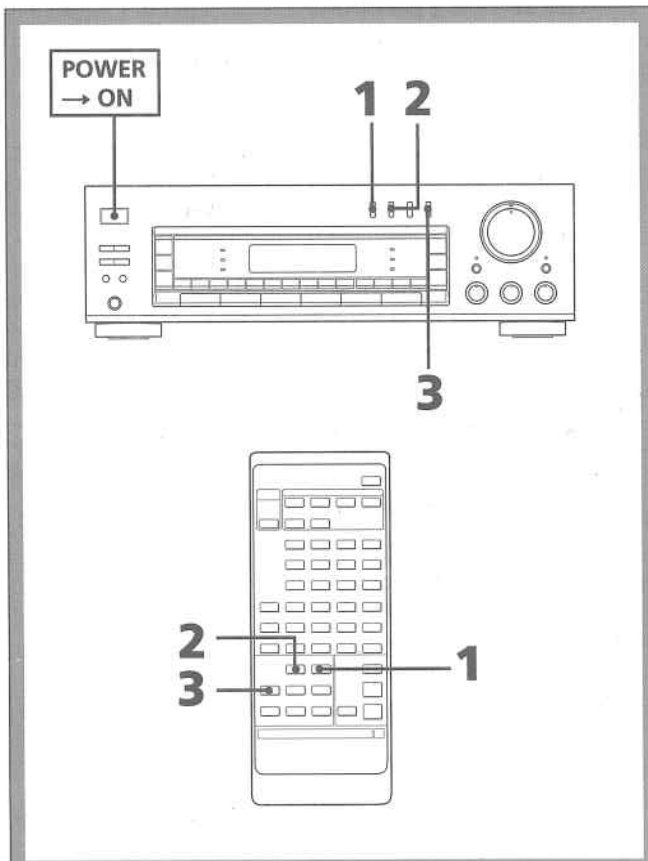

**1** Press SUR (SURROUND) ON/OFF to ON.

**2** Press SUR (SURROUND) MODE to select DOLBY.

**3** Press DELAY TIME to adjust the delay time.

The delay time changes cyclically each time you press DELAY TIME and DELAY S, DELAY M or DELAY L appears on the display according to the time listed below.

S = 15 msec.

M = 20 msec.

L = 30 msec.

### To turn off the surround effect

Press SUR (SURROUND) ON/OFF to OFF. The sound without surround effect will resume.

Rear level, center level and delay time of the surround is memorized each time the DELAY TIME, REAR LEVEL -/+ and CENTER LEVEL -/+ buttons are adjusted. They will be recalled when the surround mode is resumed.

The receiver is preset in the factory to get an optimum rear level as long as each speaker has an equal efficiency.



# Troubleshooting Guide

Before proceeding through the check list below, examine the connections and the procedures outlined in the manual.  
Should any problem persist after you have checked the following items, consult your nearest Sony dealer.

Problem	Cause	Solution
The STEREO indicator flickers or does not appear when receiving stereo programs.	A very weak FM station or a noisy FM program is received.	Adjust the antenna or connect an external FM antenna. Press FM MODE to MONO mode.
No station can be tuned in by Automatic Tuning operation.	The AM tuning interval is set incorrectly. (For U.S.A. and Canada models.)	Change the tuning interval according to the AM frequency allocation system of your country. (See page 21)
	The signal strength of the station is too weak for Automatic Tuning.	Adjust the antenna. Directly tune in the stations. (See page 9)
No stations can be tuned in with scan tuning.	No stations have been preset.	Preset the stations. (See page 10)
No sound is heard even if you adjust VOLUME.	The speaker or program source equipment is not connected correctly.	Connect the equipment correctly.
	The SPEAKERS A/B buttons are not set correctly.	Set the buttons correctly. If the A and B buttons are both depressed, check that both speaker systems are properly connected.
	A wrong function selector has been pressed.	Press the correct function selector.
No sound is heard from center speaker.	The PHANTOM mode is selected in the CENTER MODE.	Sound from the center speaker cannot be heard in the PHANTOM mode. Select another mode. (See page 16)
	The level of the center speaker is very low.	Adjust the level of the center speaker correctly. (See page 17)
	The HALL or SIMULATED surround mode is selected.	Sound from the center speaker cannot be heard in these modes. (See page 16)
No sound or sound at very low level is heard from rear speakers.	Surround function is turned off.	Press SUR ON/OFF to turn on the function.
	The 3CH LOGIC mode is selected in the CENTER MODE.	Sound from the rear speakers cannot be heard in the 3CH LOGIC mode. Select another mode. (See page 16)
	The level of the rear speakers is very low.	Adjust the level of the rear speakers correctly. (See page 17)
	Monaural program source is played back in DOLBY surround mode.	Select HALL or SIMULATED surround mode.
Surround effect cannot be obtained.	Surround circuit is turned off.	Press SUR ON/OFF.
	The unit is in a wrong mode.	Press SUR MODE to set the appropriate surround mode.

# Troubleshooting Guide

Problem	Cause	Solution
There is an abrupt loss of sound from one or both of the speakers, or the PROTECT indicator flickers in the display window.	A short-circuit problem activates the protective circuit.	Turn off the unit, eliminate the short-circuit problem and turn on the power again. If there is no short-circuit problem, consult your nearest Sony dealer.
Sound is heard only at a very low volume.	MUTING has been pressed. (The muting indicator is lit.)	Press the button to cancel the muting function.
Sound is heard only from one channel, or the volume from the left and right speakers is unbalanced.	The BALANCE control is not set appropriately.	Adjust the BALANCE control.
	The speaker or program source is not connected correctly.	Check and properly connect the equipment.
Sound from the speakers is reversed.	The speakers are not connected correctly.	Connect the right speaker to the R SPEAKER terminals and the left speaker to the L SPEAKER terminals.
There is lack of bass sound or the instrument position is obscure.	The ⊕/⊖ connection of the speaker is reversed.	Connect the speaker with the correct phase.
Severe hum or noise is heard.	The connecting cords are not shielded type.	Use shielded type cords.
	A transformer, motor, TV or fluorescent light affects the connecting cords.	Place the connecting cords in a location away from a transformer or motor, and at least 3 meters (10 feet) from a TV set or a fluorescent light.
	The audio components are too close to a TV set.	Place TV away from the audio components.
	The unit is not grounded.	Connect the ground wire to the antenna ground terminal.
	The connections are loose.	Make secure connections.
	The plugs and jacks are dirty.	Wipe the plugs and jacks with a cloth lightly dampened with alcohol.
The remote commander will not operate.	The batteries are exhausted.	Replace the batteries with new ones.
	The commander head is not pointed toward the unit's front.	Point the commander head toward the receiver.

# Specifications

(For USA and Canadian models)

## Audio Power Specifications

### POWER OUTPUT AND TOTAL HARMONIC DISTORTION

**With 8-ohm load, both channels driven, from 40 - 20,000 Hz, rated 100 watts (STR-D615) or 70 watts (STR-D515) per channel minimum RMS power, with less than 0.8% total harmonic distortion from 250 milliwatts to rated output.**

SUR (surround) MODE (8 ohms, less than 0.8% total harmonic distortion)

	STR-D615	STR-D515
FRONT	70 W per channel	70 W per channel
CENTER (only in the DOLBY mode)	70 W	20 W
REAR (Spk. Parallel use)	20 W	20 W

## Other Specifications

### Amplifier section

Continuous RMS power output (8 ohms, at 40 Hz - 20 kHz less than 0.8% total harmonic distortion)

STR-D615: 100 W + 100 W (FRONT)

STR-D515: 70 W + 70 W

Dynamic power (at 1 kHz IHF) (FRONT)

STR-D615: 140 W + 140 W (8 ohms), 210 W + 210 W (4 ohms)

STR-D515: 95 W + 95 W (8 ohms), 140 W + 140 W (4 ohms)

Harmonic distortion

Less than 0.8% at rated output

Frequency response

PHONO: RIAA equalization curve  $\pm 0.5$  dB

CD

VIDEO

TAPE

10 Hz - 50 kHz  $\pm 1$  dB

Inputs

	Sensitivity	Impedance	S/N (weighting network, input level)
PHONO	2.5 mV	50 kilohms	75 dB (A) 75 dB* (A, 5.0 mV)
CD	300 mV	50 kilohms	82 dB (A) 82 dB* (A, 500 mV)
VIDEO, TV/LD TAPE/MD	250 mV		

\* '78 IHF

Outputs

REC OUT, VIDEO (AUDIO) OUT	Voltage 250 mV Impedance 10 kilohms
HEADPHONES	Accepts low and high impedance headphones

Tone controls

BASS:  $\pm 8$  dB at 100 Hz

TREBLE:  $\pm 8$  dB at 10 kHz

Muting

-20 dB

LOW BOOST

+10 dB at 70 Hz

## Video section

INPUT	VIDEO, TV/LD	1 V <sub>p-p</sub> 75 ohms
OUTPUT	VIDEO MONITOR	1 V <sub>p-p</sub> 75 ohms

## Tuner section

	FM tuner section	AM tuner section
Tuning range	87.5 — 108 MHz	530 - 1710 kHz (10 kHz step)** 531 - 1710 kHz (9 kHz step)
Antenna terminals	300 ohms, balanced 75 ohms, unbalanced	External antenna terminal
Sensitivity at 50 dB quieting	18.3 dBf, 4.5 $\mu$ V (mono) 38.3 dBf, 45 $\mu$ V (stereo)	—
Usable sensitivity	11.2 dBf, 2 $\mu$ V (IHF)	Loop antenna: 500 $\mu$ V (at 1,000 kHz)
Signal-to-noise ratio	76 dB (mono) 70 dB (stereo)	54 dB (at 50 mV/m)
Harmonic distortion	0.3% (mono), 0.5% (stereo) at 1 kHz	0.5% (at 50 mV/m, 400 Hz)
Selectivity	60 dB at 400 kHz	40 dB at 10 kHz
Separation	45 dB at 1 kHz	—
Frequency response	30 Hz — 15 kHz $+0.5$ dB $-2$	—

## General

System

Tuner section: PLL quartz-locked digital synthesizer system

Preamplifier section: low-noise NF type equalizer amp

Power amplifier section: pure complementary SEPP

Power requirements

120 V AC, 60 Hz

Power consumption

U.S.A. model: 186 W (STR-D615)

170 W (STR-D515)

Canadian model: 290 VA (STR-D615)

195 W (STR-D515)

AC outlet

One switched (120 W/1A Max.)

Dimensions

Approx. 430 x 135 x 295 mm (w/h/d)

(17 x 5 <sup>3</sup>/<sub>8</sub> x 11 <sup>5</sup>/<sub>8</sub> inches)

including projecting parts and controls

Mass

Approx. 7.2 kg (16 lb 2 oz) (STR-D615)

Approx. 6.3 kg (13 lb 15 oz) (STR-D515)

Accessories supplied

FM wire antenna (1)

AM loop antenna (1)

Remote Commander RM-U242 (1)

Sony batteries SUM-3(NS) (2)

Design and specifications are subject to change without notice.

\*\* For the models in U.S.A. and Canada

You can change the AM tuning interval to 9 kHz. After tuning in any AM tuning in any AM station, turn off the power of receiver once. While holding down the TUNING + button, press the POWER switch. When you change the interval, all the preset stations will be erased. To reset the interval, repeat the same procedure.

# Specifications

## (For U.K. and Australian models)

### Amplifier section

Continuous RMS power output (8 ohms, at 40 Hz - 20 kHz less than 0.8% total harmonic distortion) (FRONT)

STR-D615: 60 W + 60 W

STR-D515: 50 W + 50 W

Dynamic power (at 1 kHz IHF) (FRONT)

STR-D615: 80 W + 80 W (8 ohms), 110 W + 110 W (4 ohms)

STR-D515: 70 W + 70 W (8 ohms), 100 W + 100 W (4 ohms)

Harmonic distortion

Less than 0.8% at rated output

SUR (surround) MODE (8 ohms, less than 0.8% total harmonic distortion)

	STR-D615	STR-D515
FRONT	60 W + 60 W	50 W + 50 W
CENTER (only in the DOLBY surround mode)	50 W	20 W
REAR	20 W	20 W

Frequency response

PHONO: RIAA equalization curve  $\pm 0.5$  dB

CD

VIDEO ] 10 Hz - 50 kHz  $\pm 1$  dB

TAPE ]

Inputs

	Sensitivity	Impedance	S/N (weighting network, input level)
PHONO	2.5 mV	50 kilohms	74 dB 72 dB* (A, 2.5 mV)
CD	300 mV	50 kilohms	95 dB 80 dB* (A, 200 mV)
VIDEO, TV/LD, TAPE/MD	200 mV		

\* '78 IHF

Outputs

REC OUT, VIDEO (AUDIO) OUT	Voltage 200 mV Impedance 10 kilohms
HEADPHONES	Accepts low and high impedance headphones

Tone controls

BASS:  $\pm 8$  dB at 100 Hz

TREBLE:  $\pm 8$  dB at 10 kHz

Muting

-20 dB

LOW BOOST

+10 dB at 70 Hz

### Video section

INPUT	VIDEO, TV/LD	1 Vp-p 75 ohms
OUTPUT	VIDEO MONITOR	1 Vp-p 75 ohms

### Tuner section

	FM tuner section	AM tuner section
Tuning range	87.5 — 108 MHz	531 — 1,602 kHz
Antenna terminals	300 ohms, balanced 75 ohms, unbalanced	External antenna terminal
Sensitivity at 46 dB quieting	18.3 dBf, 4.5 $\mu$ V (mono) 38.3 dBf, 45 $\mu$ V (stereo)	—
Usable sensitivity	11.2 dBf, 2 $\mu$ V (IHF)	Loop antenna: 500 $\mu$ V (at 999 kHz)
Signal-to-noise ratio	70 dB (mono) 66 dB (stereo)	54 dB (at 50 mV/m)
Harmonic distortion	0.3% (mono), 0.5% (stereo) at 1 kHz	0.5% (at 50 mV/m, 400 Hz)
Selectivity	60 dB at 400 kHz	30 dB at 9 kHz
Separation	45 dB at 1 kHz	—
Frequency response	30 Hz — 15 kHz $+0.5$ $-2$ dB	—

### General

System

Tuner section: PLL quartz-locked digital synthesizer system

Preamplifier section: low-noise NF type equalizer amp

Power amplifier section: pure complementary SEPP

Power requirements

240 V AC, 50/60 Hz (for U.K. model)

240 V AC, 50 Hz (for Australian model)

Power consumption

165 W (STR-D615)

165 W (STR-D515)

In standby condition: 5 W

AC outlet

One switched (100 W Max.)

Dimensions

Approx. 430 x 135 x 295 mm (w/h/d)

(17 x 5  $\frac{3}{8}$  x 11  $\frac{5}{8}$  inches)

including projecting parts and controls

Mass

Approx. 6.9 kg (15 lb 4 oz) (STR-D615)

Approx. 6.4 kg (14 lb 2 oz) (STR-D515)

Accessories supplied

FM wire antenna (1)

AM loop antenna (1)

Remote Commander RM-P342 (1) (STR-D615)

Remote Commander RM-U242 (1) (STR-D515)

Sony batteries SUM-3(NS) (2)

Design and specifications are subject to change without notice.

### Note

This appliance conforms with EEC Directive 87/308/EEC regarding interference suppression.

# Identifying the Parts and Controls

## Front Panel

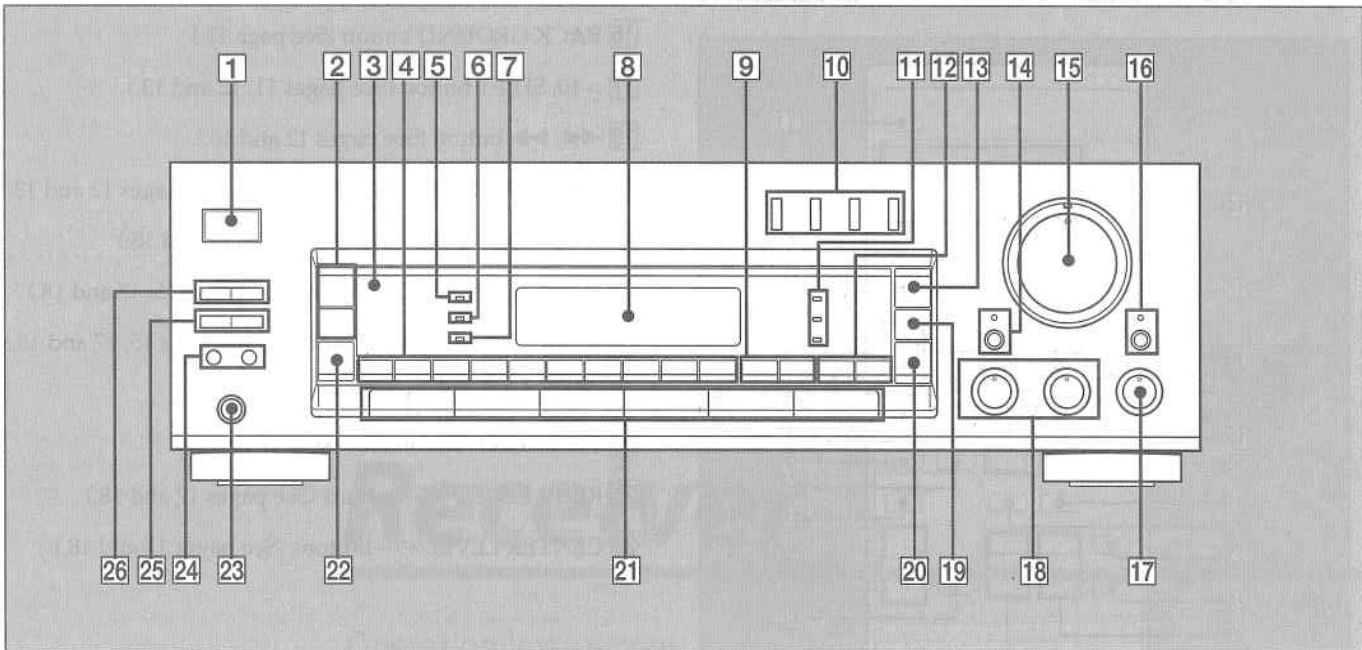

- 1 POWER switch**
- 2 FM/AM band selectors** (See pages 9 and 10.)
- 3 Remote sensor**
- 4 Numeric buttons** (See pages 9, 10 and 11.)
- 5 STANDBY indicator**  
(for U.K. and Australian models only)  
The STANDBY indicator lights up when the power cord is connected and the POWER switch is set to off.
- 6 VIDEO indicator**
- 7 TV/LD indicator** (See page 14.)
- 8 Display window**
- 9 TUNING  $\pm$  buttons** (See page 10.)
- 10 SUR (surround) ON/OFF button**  
(See pages 15, 17 and 18.)  
**SUR (surround) MODE button**  
(See pages 15, 17 and 18.)  
**CENTER MODE button**  
(See pages 15, 16 and 17.)  
**DELAY TIME button** (See page 18.)
- 11 SUR (surround) MODE indicators** (See page 15.)
- 12 PRESET TUNING  $\pm$  buttons** (See page 11.)
- 13 MEMORY button** (See page 10.)
- 14 MUTING button and indicator** (See page 8.)
- 15 MASTER VOLUME control** (See page 8.)
- 16 LOW BOOST button and indicator** (See page 8.)
- 17 BALANCE control** (See page 8.)
- 18 BASS/TREBLE controls** (See page 8.)
- 19 SHIFT button** (See pages 10 and 11.)
- 20 DIRECT button** (See page 9.)
- 21 Function selectors** (See page 8.)
- 22 FM MODE button** (See page 9.)
- 23 HEADPHONES jack** (See page 8.)
- 24 SPEAKERS A/B buttons** (See page 8.)
- 25 REAR LEVEL  $\pm$  buttons** (See pages 17 and 18.)
- 26 CENTER LEVEL  $\pm$  buttons** (See pages 17 and 18.)



# Identifying the Parts and Controls

## Remote Commander (For U.S.A. and Canadian models)

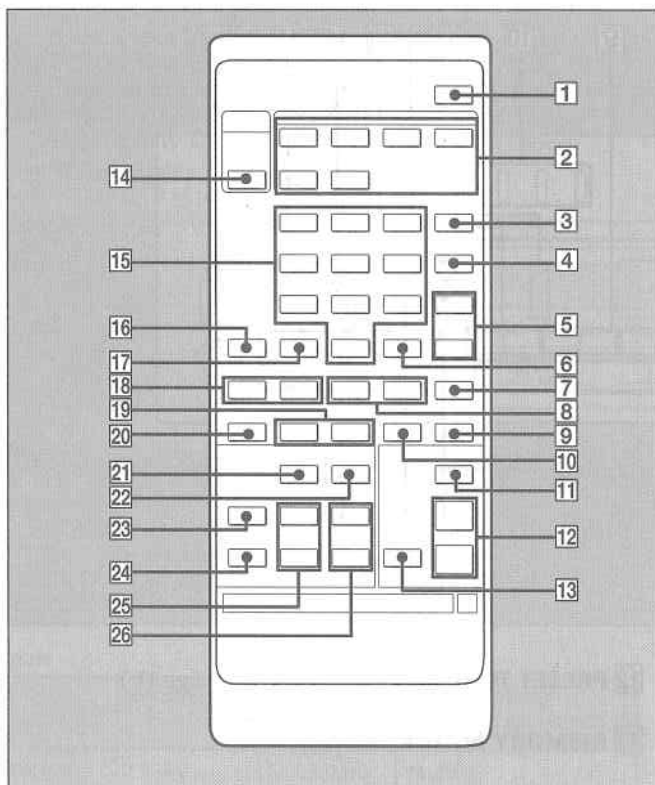

- 1** SYSTEM OFF button (See page 12.)
- 2** SYSTEM CONTROL/FUNCTION  
TAPE/MD, CD, TUNER, PHONO, VIDEO, TV/LD  
buttons (See pages 8, 12 and 14.)
- 3** VISUAL POWER button: Turns on/off the power of TV,  
VTR and LD player. (See page 13.)
- 4** TV/VIDEO selector: Switches the input of TV. (See pages  
12 and 13.)
- 5** CH/PRESET +/- buttons (See page 13.)
- 6** RMS/START, ENTER button (See pages 12 and 13.)
- 7** ANT TV/VTR, D (disc) SKIP button (See pages 12 and  
13.)
- 8** ◀▶ button (See pages 12 and 13.)
- 9** ● button (See pages 12 and 13.)
- 10** ■ button (See pages 12 and 13.)
- 11** LOW BOOST button (See pages 8 and 14.)
- 12** MASTER VOL +/- buttons (See page 8.)
- 13** MUTING button (See page 8.)

- 14** TV CONTROL ON button (See page 12.)
- 15** Numeric buttons (1 to 0) (See pages 9, 11, 12 and 13.)
- 16** BACK GROUND button (See page 13.)
- 17** > 10, SHIFT button (See pages 11, 12 and 13.)
- 18** ◀▶ button (See pages 12 and 13.)
- 19** ◀▶ RMS DIRECTION buttons (See pages 12 and 13.)
- 20** RMS CLEAR, ■ button (See pages 12 and 13.)
- 21** SURROUND MODE button (See pages 15, 17 and 18.)
- 22** SURROUND ON/OFF button (See pages 15, 17 and 18.)
- 23** DELAY TIME button (See page 18.)
- 24** TEST TONE button (See page 17.)
- 25** REAR LEVEL +/- buttons (See pages 17 and 18.)
- 26** CENTER LEVEL +/- buttons (See pages 17 and 18.)