

Technics®



AV Control Stereo Receiver

Operating Instructions

Model No. **SA-EX140**

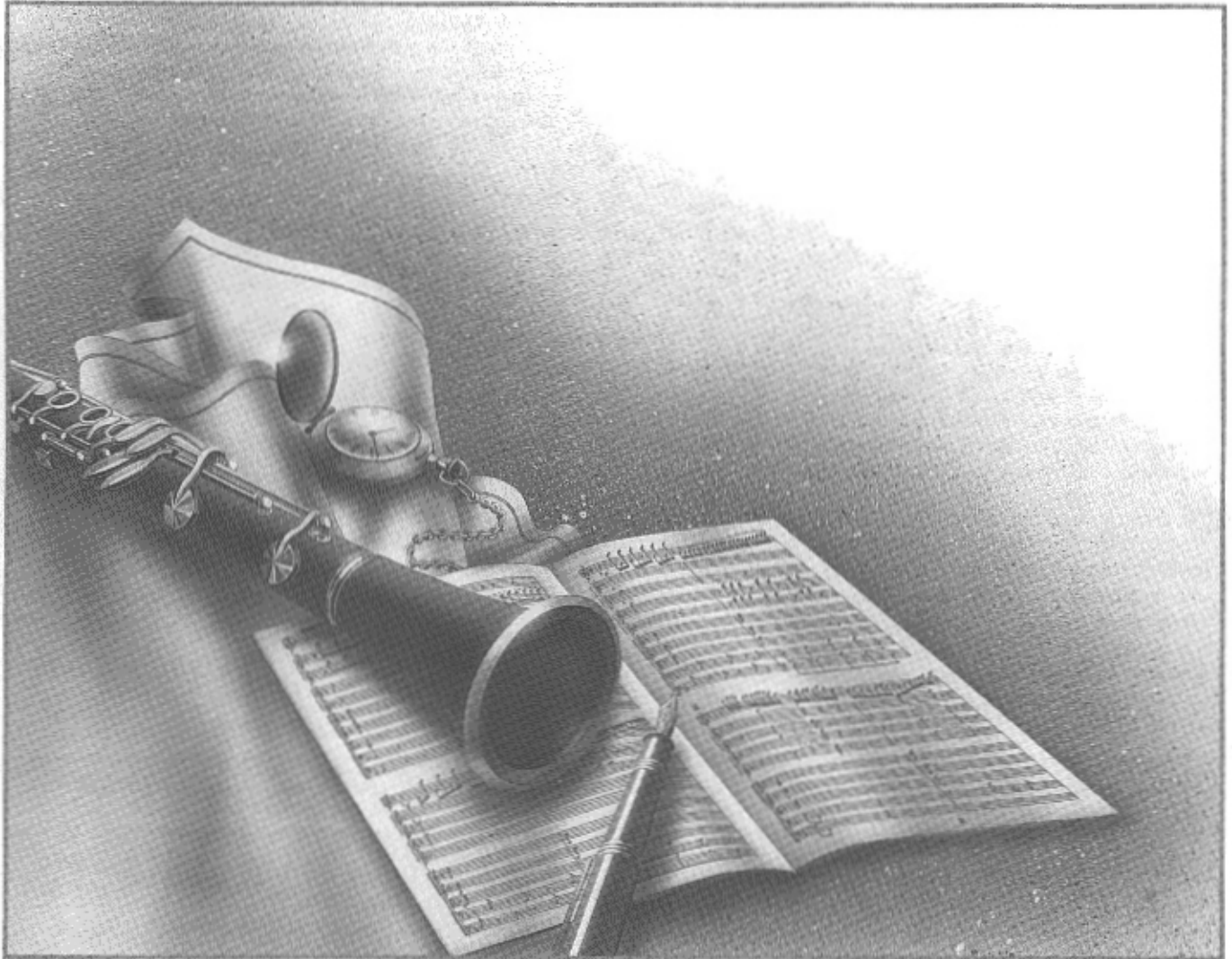

Before connecting, operating or adjusting this product, please read these instructions completely.
Please keep this manual for future reference.

Dear Customer

Thank you for purchasing this product. For optimum performance and safety, please read these instructions carefully.

Table of contents

Precautions	3
Accessories	4
Concerning the remote control	4
Front panel controls	5
Equipment connections	6
Antenna connections	7
<hr/>	
Basic operations	9
To adjust the tone quality.....	9
To adjust the sound balance.....	9
To mute the sound level.....	9
Listening to radio broadcasts	10
Sequential tuning.....	10
Direct tuning.....	10
Preset tuning.....	11
Making a recording	13
Recording on a tape deck.....	13
Recording on a VCR.....	13
To listen through headphones	13
Using the remote control	14
To operate the receiver.....	14
To operate CD changers (or CD players).....	15
To operate a cassette deck.....	16
To watch TV broadcasts.....	16
To watch video tapes.....	17
To operate laser disc player.....	17
<hr/>	
Troubleshooting guide	18
Listening caution	19
Maintenance	19
Product service	19
Technical specifications	Back Cover

User memo:

DATE OF PURCHASE _____
DEALER NAME _____
DEALER ADDRESS _____
TELEPHONE NUMBER _____

The model number and serial number of this product can be found on either the back or the bottom of the unit. Please note them in the space provided below and keep for future reference.

MODEL NUMBER SA-EX140.....
SERIAL NUMBER

THE FOLLOWING APPLIES ONLY IN THE U.S.A.

CAUTION:

This equipment has been tested and found to comply with the limits for a Class B digital device, pursuant to Part 15 of the FCC Rules.

These limits are designed to provide reasonable protection against harmful interference in a residential installation. This equipment generates, uses and can radiate radio frequency energy and, if not installed and used in accordance with the instructions, may cause harmful interference to radio communications. However, there is no guarantee that interference will not occur in a particular installation. If this equipment does cause harmful interference to radio or television reception, which can be determined by turning the equipment off and on, the user is encouraged to try to correct the interference by one of the following measures:

- Reorient or relocate the receiving antenna.
- Increase the separation between the equipment and receiver.
- Connect the equipment into an outlet on a circuit different from that to which the receiver is connected.
- Consult the dealer or an experienced radio/TV technician for help.

Any unauthorized changes or modifications to this equipment would void the user's authority to operate this device.



This device complies with Part 15 of the FCC Rules. Operation is subject to the following two conditions: (1) This device may not cause harmful interference, and (2) this device must accept any interference received, including interference that may cause undesired operation.

WARNING:

TO REDUCE THE RISK OF FIRE, ELECTRIC SHOCK OR PRODUCT DAMAGE, DO NOT EXPOSE THIS APPLIANCE TO RAIN, SPLASHING, DRIPPING OR MOISTURE.

CAUTION:

TO PREVENT ELECTRIC SHOCK MATCH WIDE BLADE OF PLUG TO WIDE SLOT, FULLY INSERT.

	CAUTION RISK OF ELECTRIC SHOCK DO NOT OPEN	
<p>CAUTION: TO REDUCE THE RISK OF ELECTRIC SHOCK, DO NOT REMOVE SCREWS. NO USER-SERVICEABLE PARTS INSIDE. REFER SERVICING TO QUALIFIED SERVICE PERSONNEL.</p>		



The lightning flash with arrowhead symbol, within an equilateral triangle, is intended to alert the user to the presence of uninsulated "dangerous voltage" within the product's enclosure that may be of sufficient magnitude to constitute a risk of electric shock to persons.



The exclamation point within an equilateral triangle is intended to alert the user to the presence of important operating and maintenance (servicing) instructions in the literature accompanying the appliance.

Precautions

Before using this unit please read these operating instructions carefully. Take special care to follow the warnings indicated on the unit itself as well as the safety suggestions listed below. Afterwards keep them handy for future reference.

Safety

- Power Source** — The unit should be connected to power supply only of the type described in the operating instructions or as marked on the unit.
- Polarization** — If the unit is equipped with a polarized AC power plug (a plug having one blade wider than the other), that plug will fit into the AC outlet only one way. This is a safety feature. If you are unable to insert the plug fully into the outlet, try reversing the plug. If the plug should still fail to fit, contact your electrician to replace your obsolete outlet. Do not defeat the safety purpose of the polarized plug.
- Power Cord Protection** — AC power supply cords should be routed so that they are not likely to be walked on or pinched by items placed upon or against them. Never take hold of the plug or cord if your hand is wet, and always grasp the plug body when connecting or disconnecting it.
- Nonuse Periods** — When the unit is not used, turn the power off. When left unused for a long period of time, the unit should be unplugged from the household AC outlet.

Installation

Environment

- Outdoor Antenna Grounding** — If an outside antenna is connected to the receiver, be sure the antenna system is grounded so as to provide some protection against voltage surges and built-up static charges. Section 810 of the National Electrical Code, ANSI/NFPA No. 70-1990, provides information with respect to proper grounding of the mast and supporting structure, grounding of the lead-in wire to an antenna discharge unit, size of grounding conductors, location of antenna-discharge unit, connection to grounding electrodes, and requirements for the grounding electrode. See figure below.

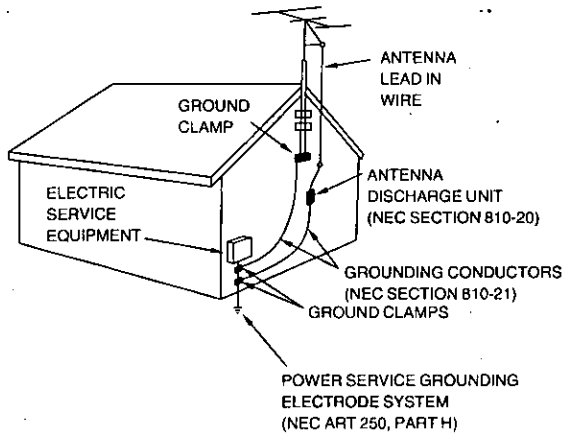

NEC—NATIONAL ELECTRICAL CODE

- Water and Moisture** — Do not use this unit near water—for example, near a bathtub, washbowl, swimming pool, or the like. Damp basements should also be avoided.
- Heat** — The unit should be situated away from heat sources such as radiators and the like. It also should not be placed in temperatures less than 5°C (41°F) or greater than 35°C (95°F).

Placement

- Ventilation** — The unit should be situated so that its location or position does not interfere with its proper ventilation. Allow 10 cm (4") clearance from the rear of the unit.
- Foreign Material** — Care should be taken so that objects do not fall into and liquids are not spilled into the unit. Do not subject this unit to excessive smoke, dust, mechanical vibration, or shock.
- Magnetism** — The unit should be situated away from equipment or devices that generate strong magnetic fields.
- Stacking** — Do not place heavy objects, other than system components, on top of the unit.
- Surface** — Place the unit on a flat, level surface.
- Carts and Stands** — The unit should be used only with a cart or stand that is recommended by the manufacturer. The unit and cart combination should be moved with care. Quick stops, excessive force, and uneven surfaces may cause the unit and cart combination to overturn.
- Wall or Ceiling Mounting** — The unit should not be mounted to a wall or ceiling, unless specified in this operating instructions.



Maintenance

Clean the cabinet, panel and controls with a soft cloth lightly moistened with mild detergent solution. Do not use any type of abrasive pad, scouring powder or solvent such as alcohol or benzine.

Service

- Damage Requiring Service** — The unit should be serviced by qualified service personnel when:
 - The AC power supply cord or the plug has been damaged; or
 - Objects have fallen or liquid has been spilled into the unit; or
 - The unit has been exposed to rain; or
 - The unit does not appear to operate normally or exhibits a marked change in performance; or
 - The unit has been dropped, or the enclosure damaged.
- Servicing** — The user should not attempt to service the unit beyond that described in the operating instructions. All other servicing should be referred to an authorized service personnel.
For the address of an authorized servicer:
In the U.S.A. 1-800-211-7262 or web site
(<http://www.panasonic.com>)
In Canada 905-624-5505 or web site (www.panasonic.ca)

CAUTION

Do not place a tape deck or CD player on top of this unit. Heat radiated from the top of this unit may cause damage to the tape or CD software.

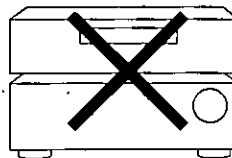

NO

Accessories

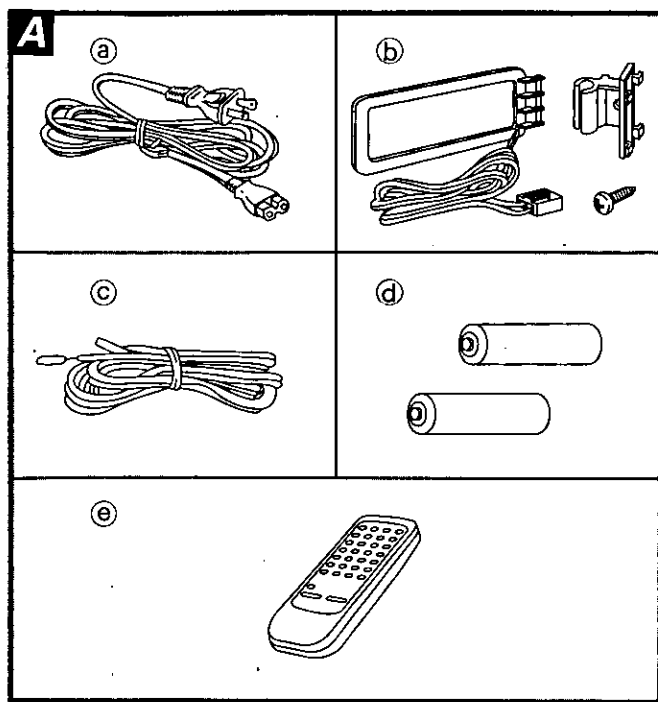

 Please check and identify the supplied accessories.

- (a) AC power supply cord (RJA0065-A) 1 pc.
- (b) AM loop antenna set (RSA0010)
 - AM loop antenna 1 pc.
 - AM loop antenna holder 1 pc.
 - Screw 1 pc.
- (c) FM indoor antenna (RSA0006) 1 pc.
- (d) Batteries 2 pcs.
- (e) Remote control transmitter (EUR644346) 1 pc.

Use numbers indicated in parentheses when asking for replacement parts.
 (Only for U.S.A.)
 To order accessories contact 1-800-332-5368 or web site (<http://www.panasonic.com>).

Note
 The included AC power supply cord is for use with this unit only. Do not use it with other equipment.

Concerning the remote control

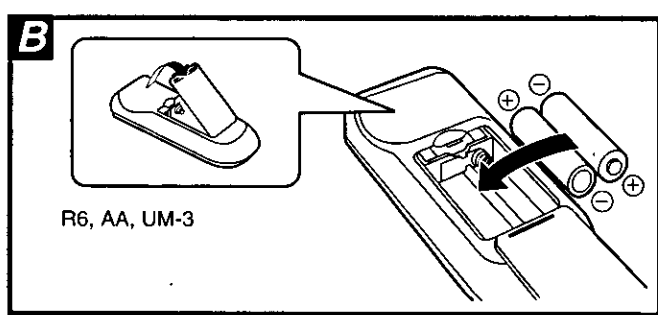

Battery installation

Use of batteries

- Align the poles (+ and -) properly when inserting the batteries.
 - Do not mix old and new batteries or different types of batteries.
 - Do not recharge ordinary dry cell batteries.
 - Do not heat or disassemble the batteries. Do not allow them to contact flame or water.
 - Remove the batteries if the unit is not to be used for a long time.
 - Do not keep together with metallic objects such as necklaces.
 - Do not use rechargeable type batteries.
- Mishandling of batteries can cause electrolyte leakage which can damage items the fluid contacts and may cause a fire.
 If electrolyte leaks from the batteries, consult your dealer.
 Wash thoroughly with water if electrolyte comes in contact with any part of your body.

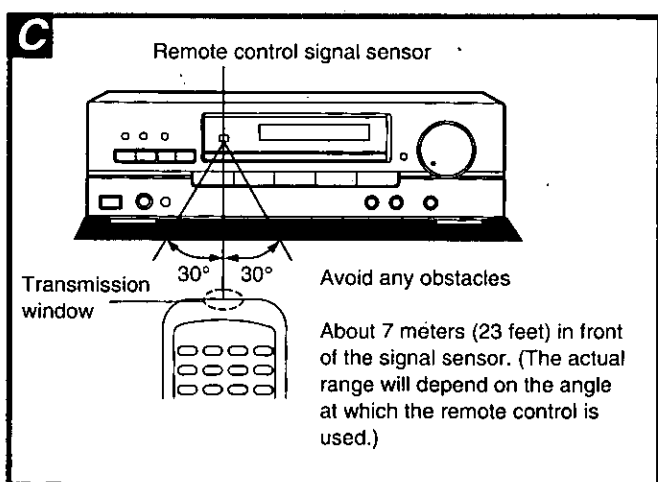

Correct method of use

Operation notes

- Do not place obstacles between the remote control signal sensor and remote control unit.
- Do not expose the remote control signal sensor to direct sunlight or to the bright light of fluorescent light.
- Take care to keep the remote control signal sensor and end of the remote control unit free from dust.
- If this unit is installed in a rack with glass doors, the glass doors' thickness or color might make it necessary to use the remote control a shorter distance from the unit.

To prevent damage

- Never place heavy items on top of the unit.
- Do not disassemble or reconstruct the unit.
- Do not spill water or other liquids into the unit.

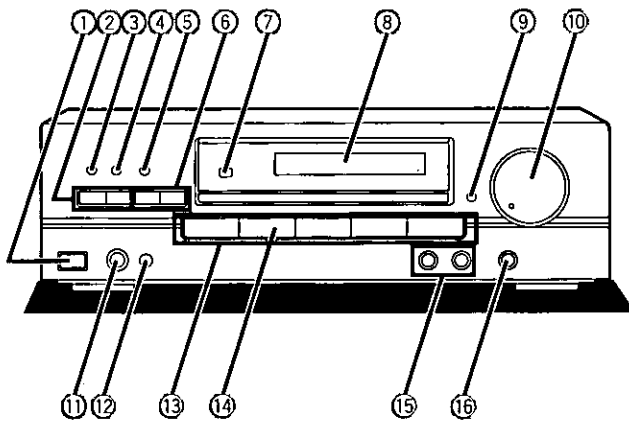
A

Front panel controls

Main unit **A**

- ① Power "⏻/⏻" switch (POWER, ⏻/⏻)
Press to switch the unit from on to standby mode or vice versa. In standby mode, the unit is still consuming a small amount of power.
- ② Tuning buttons (∨ TUNING ∧)
- ③ Band select button (BAND)
- ④ FM mode select button (FM MODE)
- ⑤ Memory button (MEMORY)
- ⑥ Preset channel buttons (∨ PRESET ∧)
- ⑦ Remote control signal sensor (SENSOR)
- ⑧ Display
- ⑨ Muting button (MUTING)
- ⑩ Volume control (VOLUME)
- ⑪ Headphones jack (PHONES)
- ⑫ Speakers select button (SPEAKERS A/B/OFF)
- ⑬ Input select buttons
- ⑭ Tape monitor button (TAPE MONITOR)
- ⑮ Tone controls (BASS, TREBLE)
- ⑯ Balance control (BALANCE)

Before use

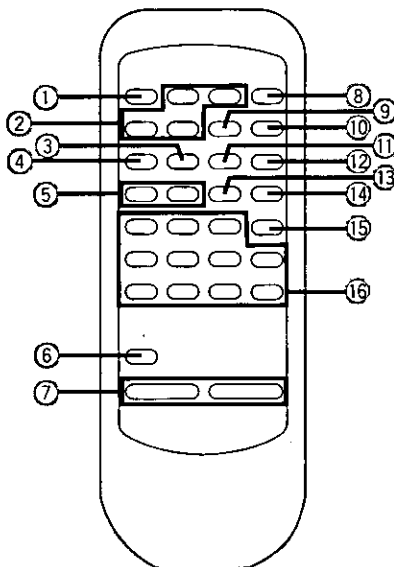
B

Remote control **B**

- ① Power button (POWER)
- ② Input and Mode select buttons (TV, VCR, TUNER, CD)
- ③ ►► / ►►► button (►► / ►►►)
- ④ ◀◀ / ◀◀◀ button (◀◀ / ◀◀◀)
- ⑤ Channel up/down buttons (∨ CH ∧)
- ⑥ Muting button (MUTING)
- ⑦ Volume buttons (- VOLUME +)
- ⑧ Mode select button (VDP)
- ⑨ Tape monitor button (TAPE MONITOR)
- ⑩ ■ button (■)
- ⑪ ◀ button (◀)
- ⑫ ▶ button (▶)
- ⑬ Ant-TV/Vcr button (ANT-TV/VCR)
- ⑭ Disc/Deck 1/2 button (DISC/DECK 1/2)
- ⑮ Direct tuning/disc enter button (DIRECT TUNING/DISC ENTER)
- ⑯ Numbered buttons

Equipment connections

Stereo connection cable (not included)

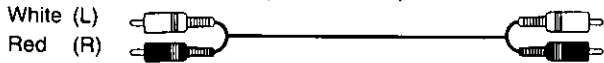

Note

Do not place books, etc., on top of this unit or block the heat radiation vents in any way.

To connect equipment, refer to the appropriate operating instructions.

Conserving power

The unit consumes 2 W even when it is turned off with [POWER].

To save power when the unit is not to be used for a long time, unplug it from the household AC outlet.

Remember to reset the radio stations and any other memory items before using the unit again.

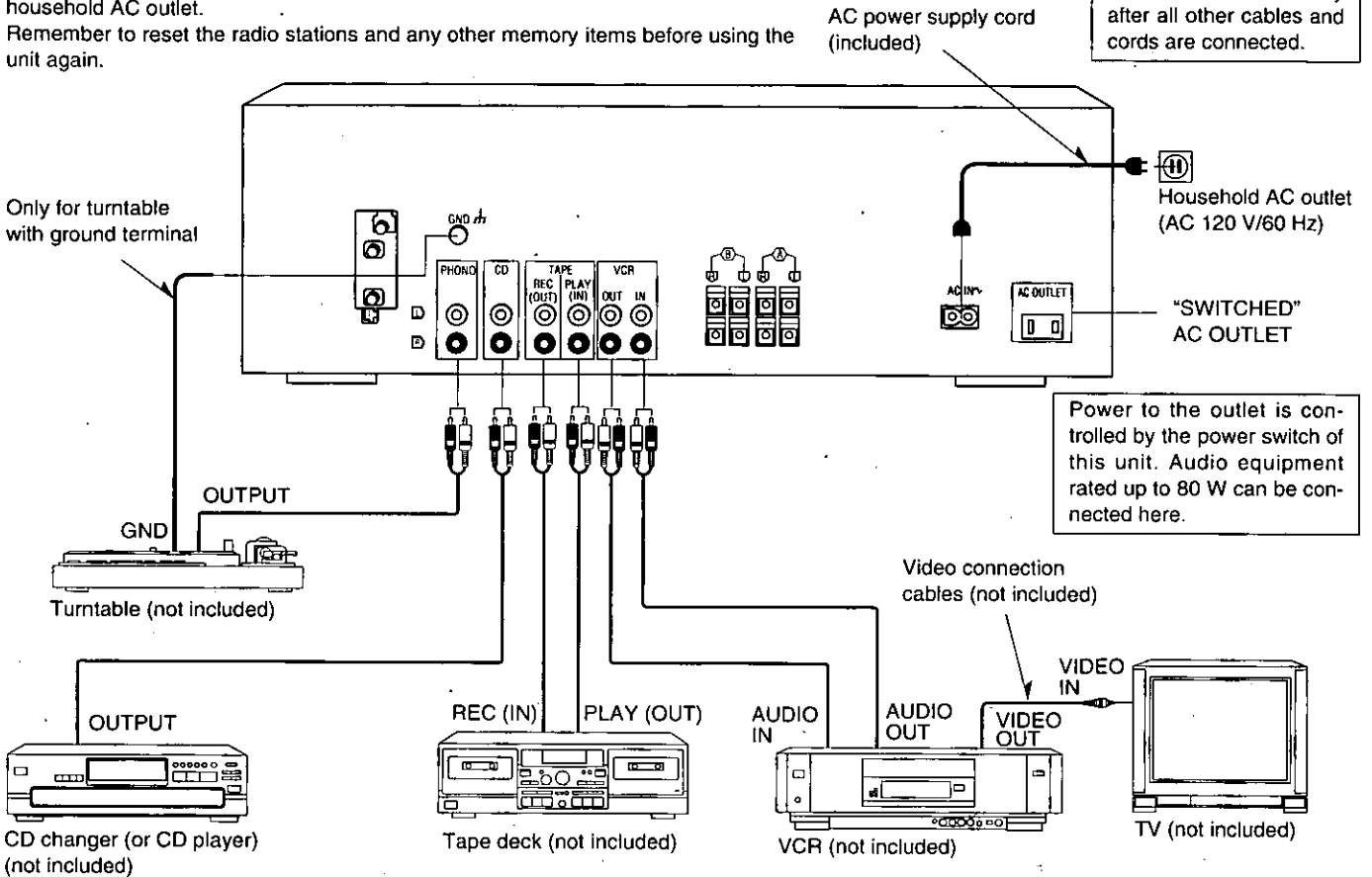

Speaker connections

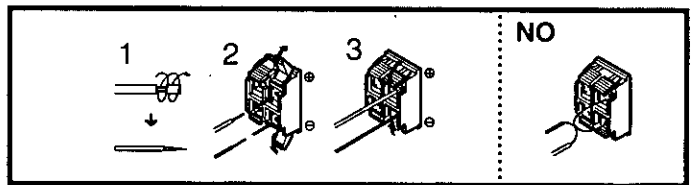
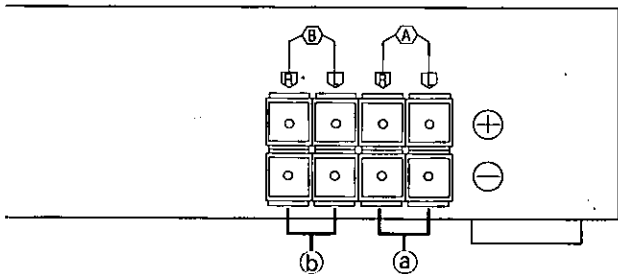

Note

To prevent damage to circuitry, never short-circuit positive (+) and negative (-) speaker wires.

a Front "A" speakers

Speaker impedance: 8 Ω

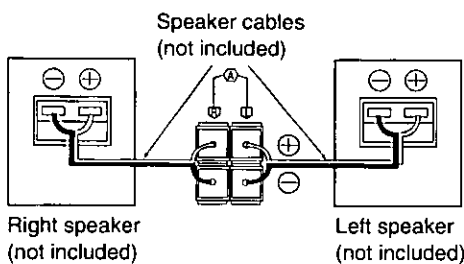

b Front "B" speakers

For connection to a second pair of speakers.

Speaker impedance: 8 Ω

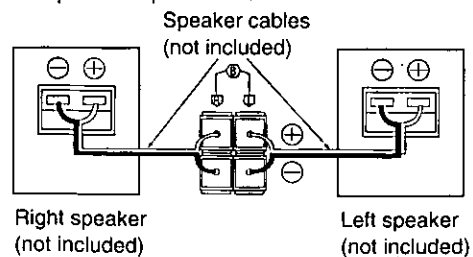

Antenna connections

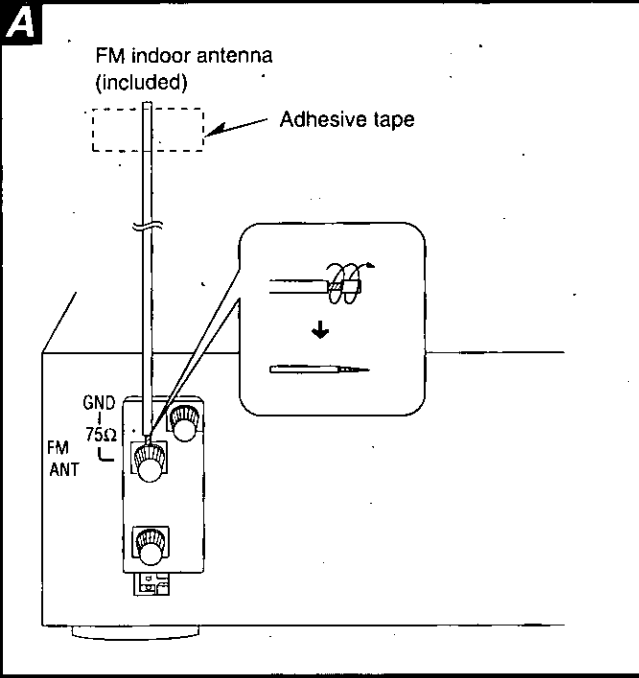

FM indoor antenna (included) **A**

This antenna is normally sufficient for reception of FM broadcasts.

Attach to a wall (using tape) facing in the direction of best reception.

For best reception sound quality

An FM outdoor antenna is recommended.

AM loop antenna (included) **B**

This antenna is normally sufficient for reception of AM broadcasts.

Install the AM loop antenna holder (included) at the rear panel of this unit and then attach the AM loop antenna to the AM loop antenna holder (facing in the direction of best reception).

Pay attention to the following points when mounting the antenna.

- Do not mount it close to power cords, speaker wires or metal surfaces (Doing so will result in noise).
- Do not mount it close to a tape deck. When the tape deck is being used, chirping or beeping sounds may result.

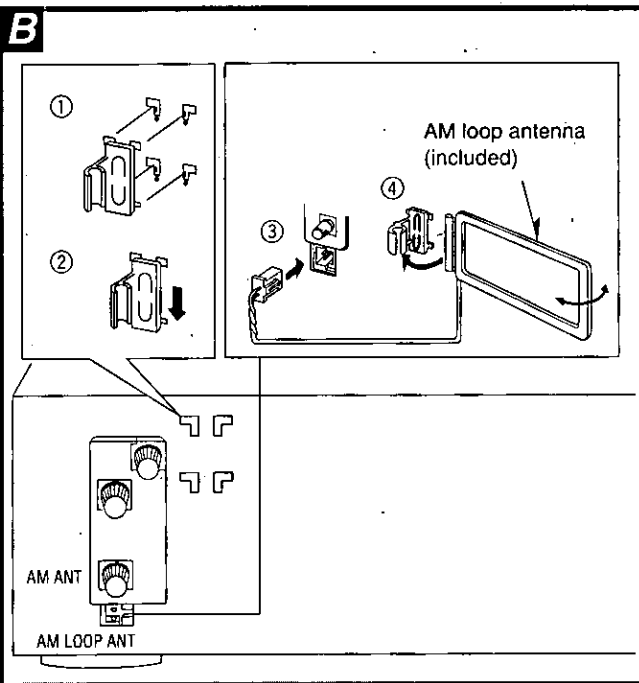

When mounting the antenna to a column, a wall or rack **C**

Mount the antenna so that the hinge is vertical.

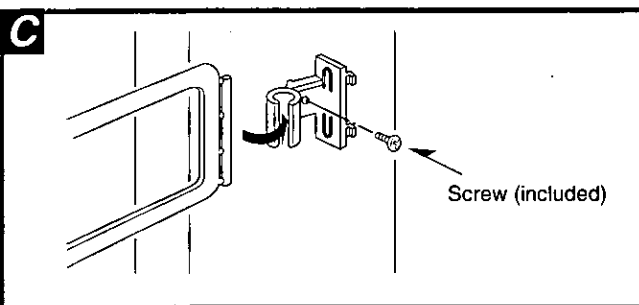

Before use

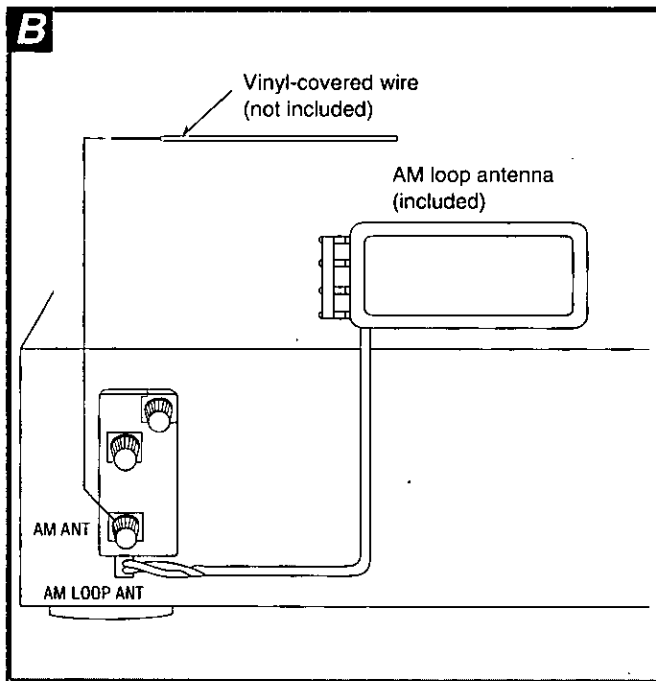
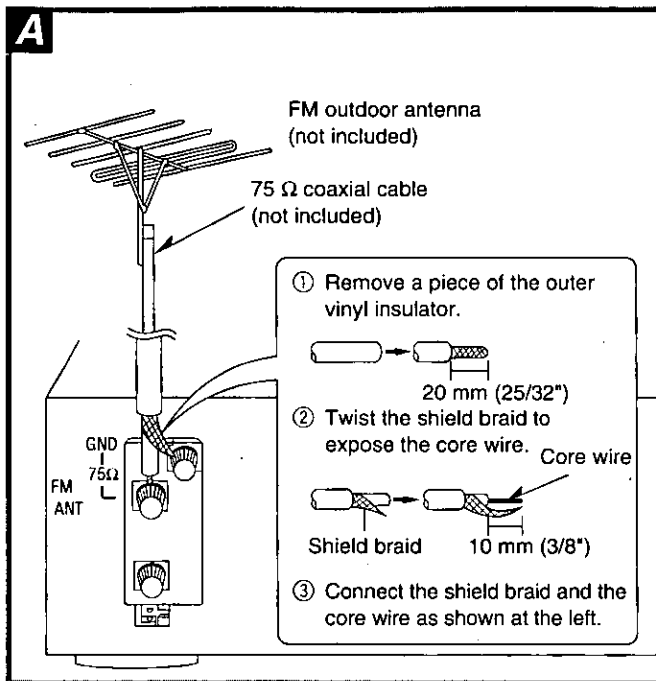

FM outdoor antenna (not included) A

The outdoor antenna should be used when using this unit in mountainous areas or in spaces enclosed by reinforced concrete where the FM indoor antenna (included) does not provide satisfactory reception. Disconnect the FM indoor antenna if an FM outdoor antenna is installed.

Note

An outdoor antenna should be installed by a qualified technician only.

AM outdoor antenna (not included) B

An outdoor antenna should be used when using this unit in mountainous areas or in spaces enclosed by reinforced concrete where the AM loop antenna (included) does not provide satisfactory reception.

Stretch 5–12 m (16–40 ft.) of vinyl-covered wire horizontally across a window frame or other convenient location, keeping it as high as possible from the ground.

When the unit is not in use, disconnect the outdoor antenna to prevent possible damage that may be caused by lightning. Never use an outdoor antenna during an electrical storm.

Note

Be sure to connect the AM loop antenna even when an outdoor antenna is used.

Basic operations

Before operation, set VOLUME to the "MIN" position.

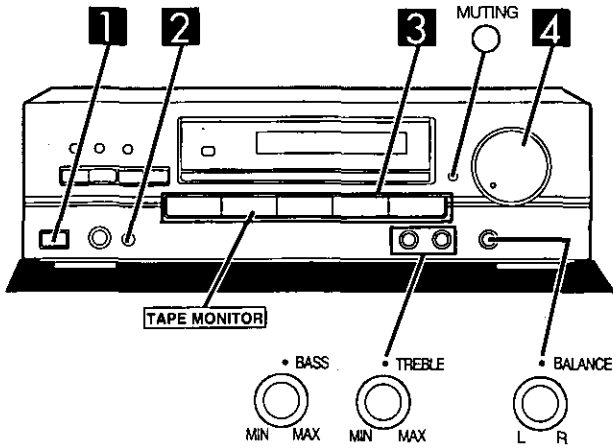

- 1** Press [POWER].
- 2** Press [SPEAKERS] to select the speaker system to be used.

Changes as follows each time the button is pressed.
SPEAKERS **A** → SPEAKERS **B** → (OFF)

Note

Speakers A and B cannot be used at the same time.

Caution

Before selecting your speaker system, make sure impedance is correct in the speakers you want to use. (See page 6.)

- 3** Press to select the desired source, and start the desired source.
(Refer to the appropriate operating instructions for details.)

VCR: To watch video tapes (VCR)

TAPE MONITOR: To listen to cassette tapes (The tape monitor indicator will appear.)
(See below.)

CD: To listen to compact discs

TUNER: To listen to radio broadcasts

PHONO: To listen to phono discs

- 4** Turn VOLUME to adjust the volume level.

After listening is finished

Be sure to reduce the volume level, and switch the power to the standby condition by pressing [POWER].

When the tape monitor indicator is lit or flashing **A**

This indicates that the tape monitor function of this unit is ON. To listen to sources other than a tape, be sure to press [TAPE MONITOR] and check the indicator goes out.

To adjust the tone quality **B**

Turn [BASS] to adjust the low frequency sound.
Turn [TREBLE] to adjust the high frequency sound.

To adjust the sound balance **C**

Turn [BALANCE] to adjust the left/right sound balance.

To mute the sound level **D**

Press [MUTING].

The message "MUTING ON NOW" runs repeatedly from right to left across the display as long as the muting function is on.

Press once again to return to the previous volume level.

Note

When the receiver is turned off, the muting operation will be automatically cancelled.

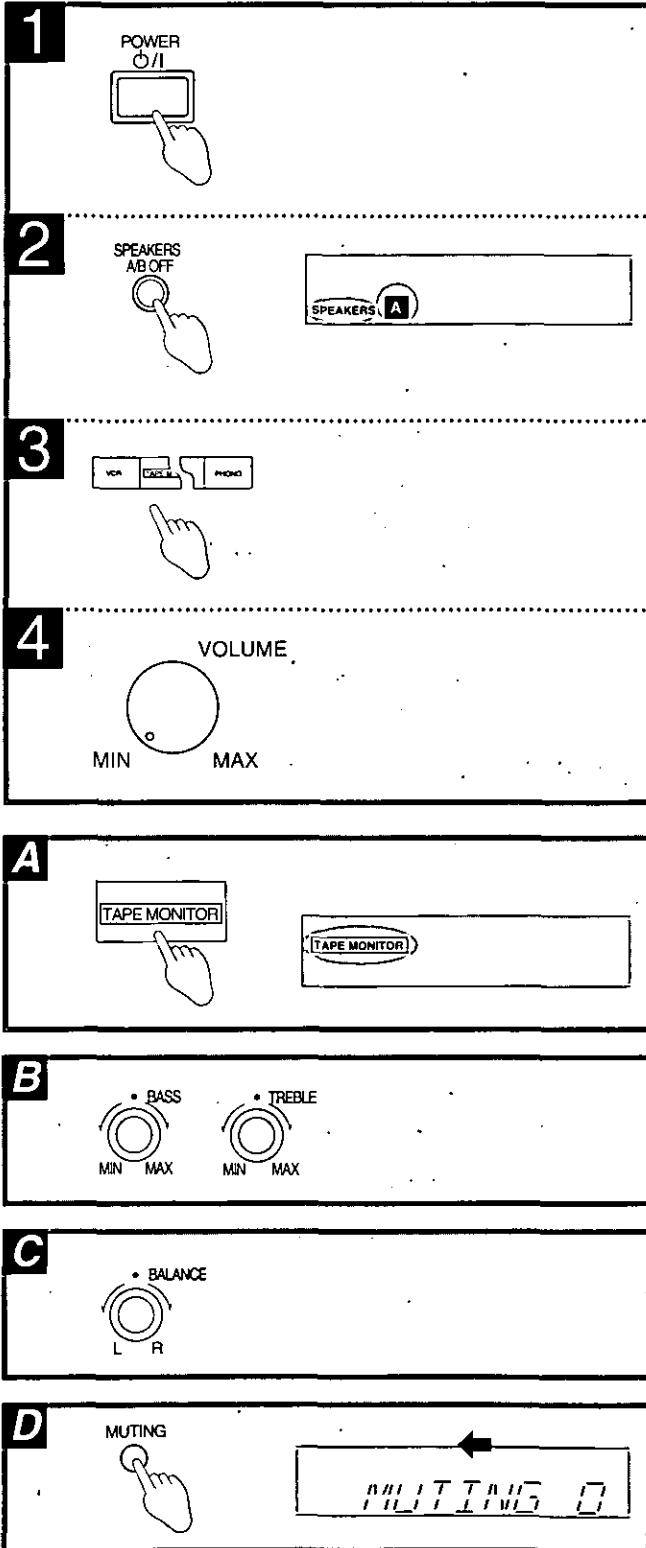

Sequential tuning

You can use the tuning buttons to tune-in radio broadcasts.

- 1** Press [TUNER].
- 2** Press [BAND] to select "FM" or "AM".
- 3** Press [TUNING (∨) or (∧)] to tune to the desired broadcast.

Tuning intervals FM: 0.2 MHz
AM: 10 kHz

"QUARTZ LOCK" lights up when tuned.

"STEREO" lights up when an FM stereo broadcast is received.

To make an automatic search for broadcast stations

If [TUNING (∨) or (∧)] is held down for an instant until the frequency begins to scroll, the broadcast stations can be tuned in automatically when a broadcast station is found.

Note

Tuning may stop automatically if any jamming is encountered.

If noise is excessive in the FM stereo mode

Press [FM MODE].

(The "STEREO" indicator will go out, and the "MONO" indicator will light up.)

The broadcast will be monaural, but noise will be reduced.

If the button is pressed once more, the stereo mode will be resumed.

Direct tuning

(Only available from the remote control.)

Specify the frequency using the numbered buttons on the remote control transmitter to directly tune to the desired broadcast station.

First select between FM and AM with the [BAND] button on the receiver.

- 1** Press [TUNER].
This will set the remote control to operate the tuner.
- 2** Press [DIRECT TUNING/DISC ENTER].
- 3** Press the appropriate numbered buttons to enter the frequency, while cursor display is flashing.

Tuning intervals FM: 0.1 MHz
AM: 10 kHz

If the desired FM frequency is 107.9 MHz, press

1 → 0 → 7 → 9

If the frequency has been input correctly, the displayed frequency will blink once.

Note

1. If no button is pressed while the cursor display is flashing, the display will return to the frequency which is currently being received. To re-specify the frequency, repeat the procedure from step 2.
2. If the frequency has not been input correctly, "ERROR" will be displayed. In this case, re-enter the frequency.

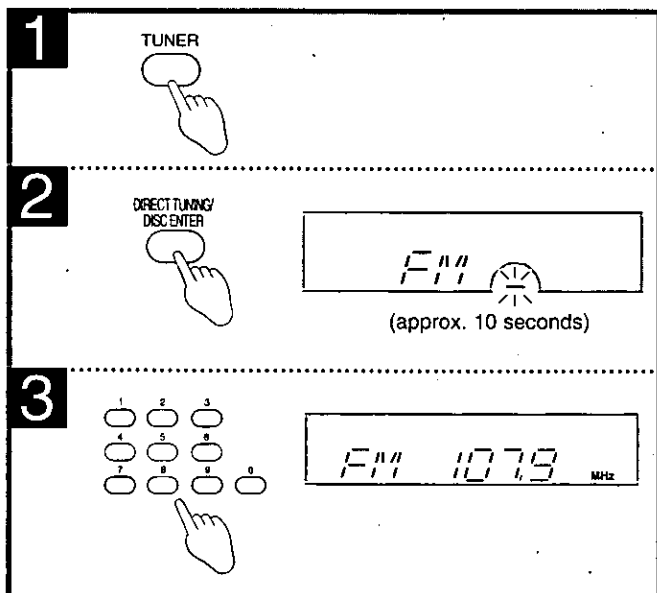
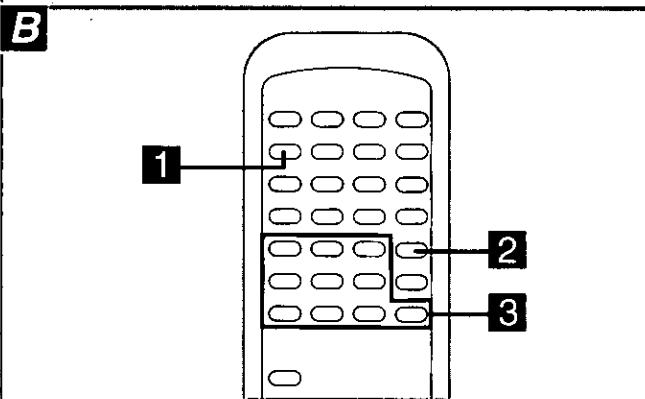
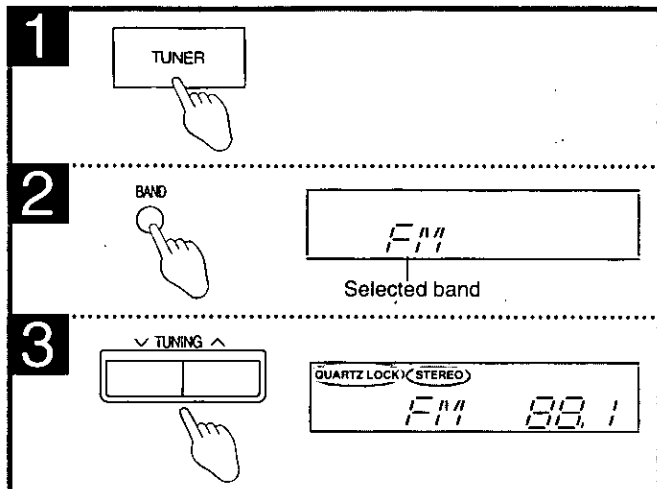
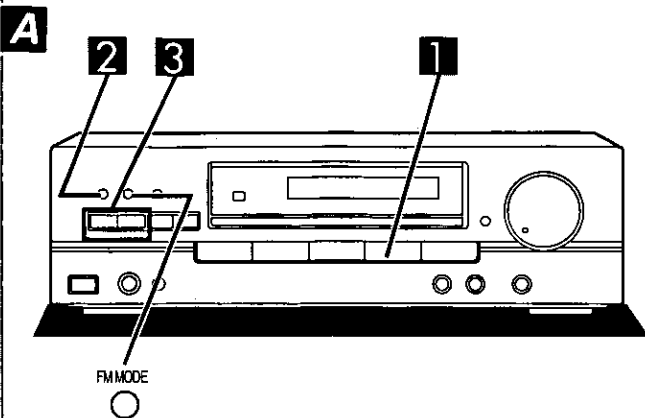

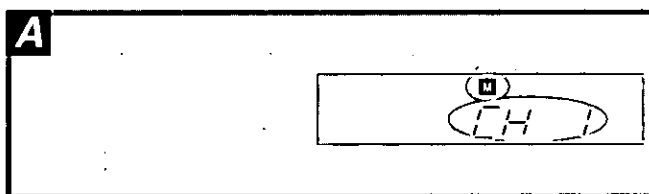
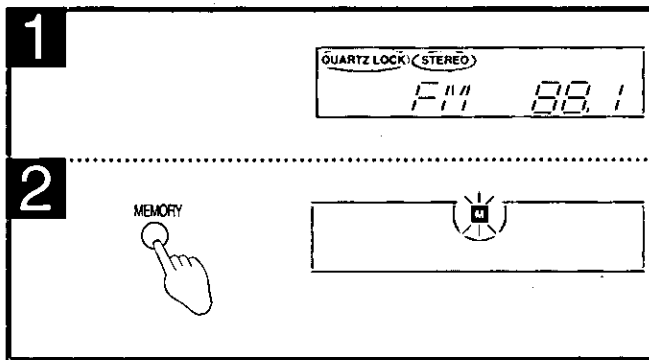
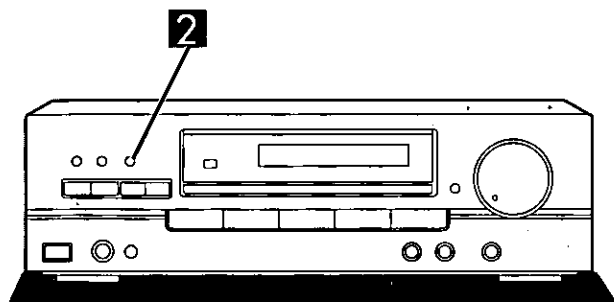

Preset tuning

Presetting radio stations into the memory channels of this unit makes selecting stations simple.

A total of 30 FM and AM stations can be preset.

Please remember this

If a new station is preset into a channel, the station previously entered in that channel will be erased.

Automatic memory presetting

Automatic memory presetting allows this unit to search for stations and then preset them into memory.

With this method, the channels that can be preset into the memory are set as follows for different bands (FM or AM).

When FM stations are preset,

For FM stations1-30

When FM and AM stations are preset,

For FM stations1-20

For AM stations21-30

1 Set to the frequency from which you want to start automatic memory presetting. (See page 10.)

2 Press [MEMORY] until the frequency begins to change.
(Automatic memory presetting will start.)
During automatic memory presetting, the memory indicator will flash while the frequency scrolls.

To stop, press [MEMORY] once again.

When a broadcast station is preset **A**

The memory indicator and the preset channel number will be displayed for approximately 1 second.

When presetting is completed

The last station to be preset will be displayed.

Note

Frequencies may not be preset correctly in cases where the broadcast waves are too strong or too weak. In such cases, carry out presetting manually. (See page 12)

A

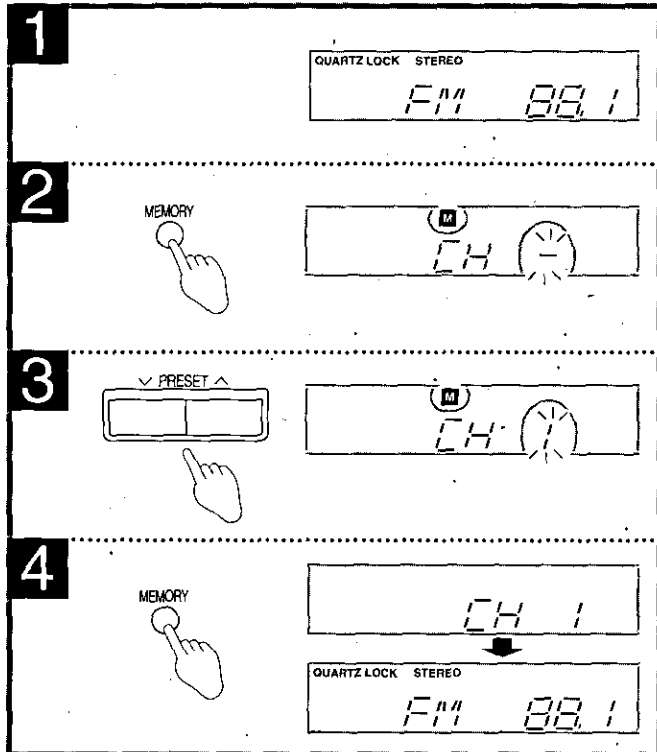
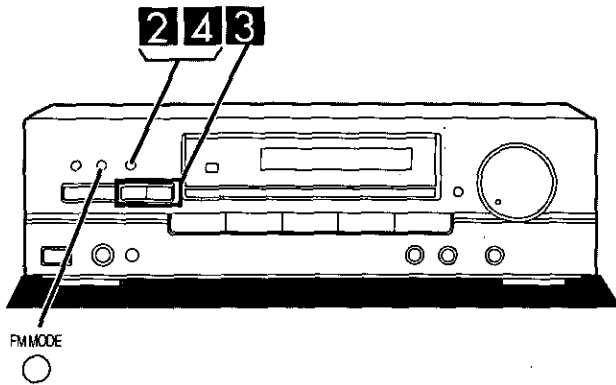

B

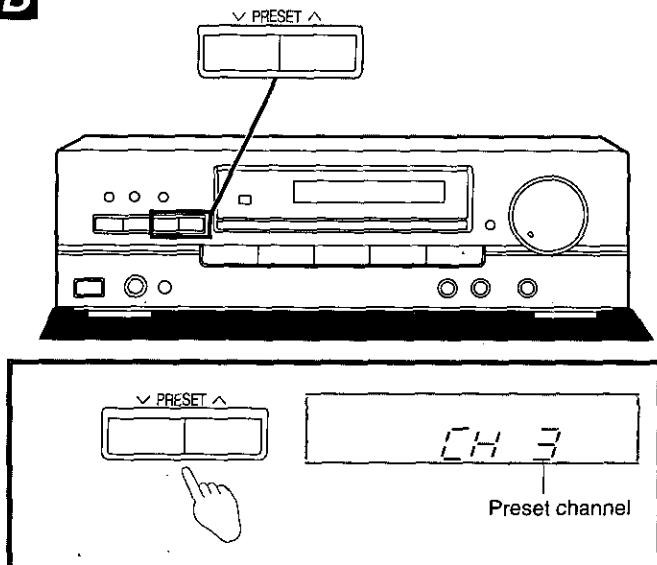

Listening to radio broadcasts

Manual memory presetting A

The desired broadcast stations can be preset into the desired channels by the user.

1 Tune to the desired station.
(See page 10.)

If interference or static is keeping you from enjoying an FM broadcast, press [FM MODE] and change to monaural. You can preset the memory in monaural just as in stereo.

2 Press [MEMORY].
To cancel the memory function, press [MEMORY] again.

3 Press [PRESET (v) or (^)] to select the desired channel.
Holding the buttons down lets you scroll through channels faster.

4 Press [MEMORY].
The channel will blink on the display.

To continue presetting
Repeat steps 1 through 4.

To listen to preset broadcast stations B

Press [PRESET (v) or (^)] to select the desired channel.
Holding the buttons down lets you scroll through channels faster.

To confirm the channel number of the station
Press [TUNER].
(The channel number will be displayed for approximately 1 second.)

Note
The channel number is not displayed if you change the reception frequency or FM mode setting.

For your reference
Even if the power cord is disconnected from the household AC outlet, the memory will retain its contents for approximately one month.

If preset channels are accidentally erased
Make the presettings once again.
The power cord should remain connected for one hour or more for the memory back-up to be effective.

Making a recording

Recording on a tape deck **A**

Before recording, prepare the tape deck for recording (recording level adjustment, etc.).
See the tape deck's operating instructions for details.

- 1 Select the source to be recorded.**
Press any button except **TAPE MONITOR** to select the source you want to record from.
- 2 Begin recording.**
Follow your tape deck's operating instructions.
- 3 Begin the source to be recorded.**

To check the sound recorded while a recording is being made **B**

With a tape deck with 3 head system, it is possible to check the sound recorded on the tape.

Press **TAPE MONITOR** on this unit and set the monitor button on the tape deck to "TAPE".

Press **TAPE MONITOR** once again to turn it off.

Recording on a VCR

Before recording, prepare the VCR for recording (recording level adjustment, input selector setting, etc.).
See the VCR's operating instructions for details.

Recording from an audio source **C**

- 1 Select the audio source to be recorded.**
Press either CD, TUNER or PHONO to select the source you want to record from.
Note
Recording from the tape deck is not possible.
- 2 Begin recording on the VCR.**
Follow your VCR's operating instructions.
- 3 Begin the audio source to be recorded.**

To listen through headphones **D**

- 1 Use VOLUME to reduce the volume level.**
- 2 Connect the headphones.**
Plug type: 6.3 mm (1/4 in.) stereo
- 3 Use VOLUME to adjust the volume level.**

If you do not want sound from the speakers, press **[SPEAKERS]** and check the speaker indicator goes out.

Note

Avoid listening for prolonged periods of time to prevent hearing damage.

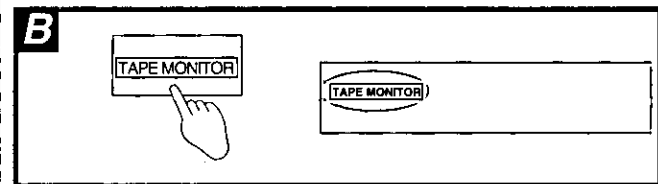
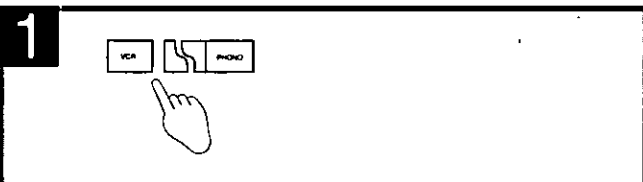
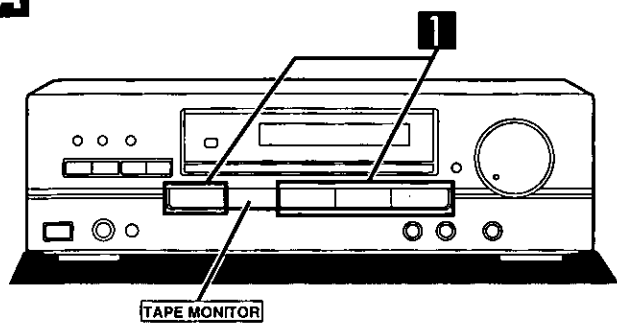
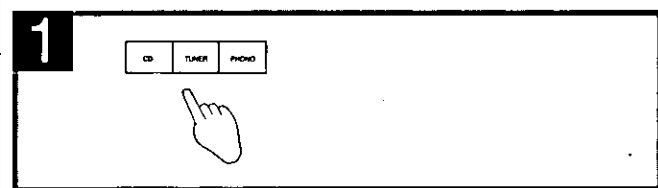
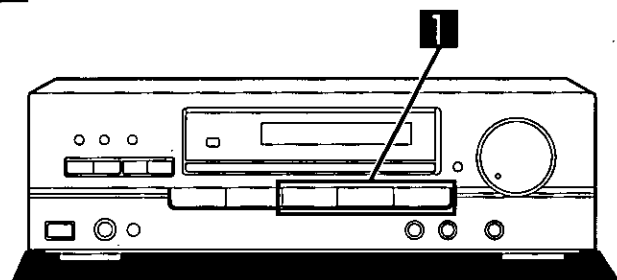
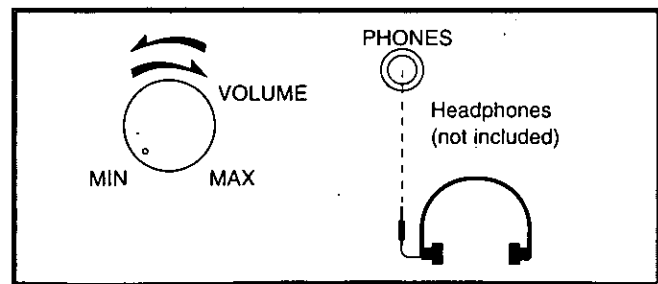
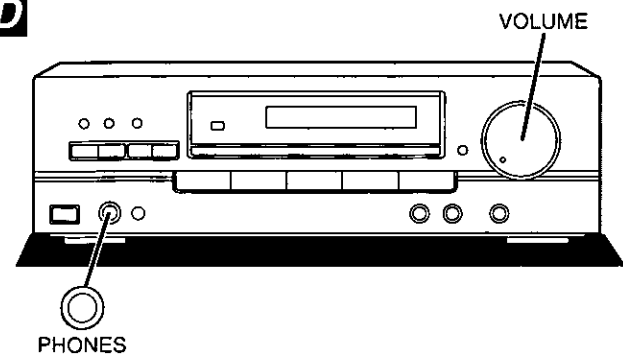
A**C****D**

Using the remote control

This remote control can be used to operate the receiver you purchased and some other Panasonic and Technics compact cassette decks, CD changers (and CD players), TVs, VCRs, and VDP provided they are equipped with a remote control sensor.

To operate the receiver

Facing toward the receiver

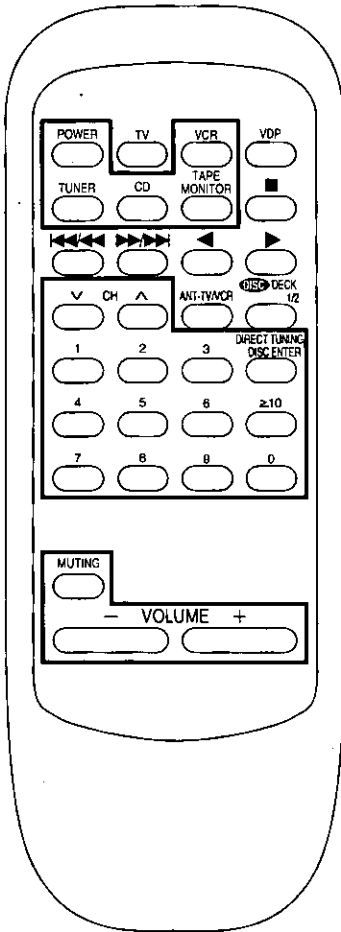

Basic operations

To turn the power ON/OFF

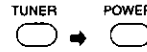

Once the power has been set to ON, it can be turned ON and OFF simply by pressing [POWER].

To select an input source

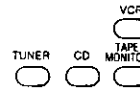

- PHONO can not be selected with this remote control.
- Selecting [TAPE MONITOR] turns ON the tape monitor function. Pressing it again or another input select button turns the function OFF.

To mute the sound level



The message "MUTING ON NOW" runs repeatedly from right to left across the display as long as the muting function is on. Press once more to return to the original volume.

To adjust the volume level



Note

After turning the power of the TV, VCR or laser disc player ON or OFF, always press [TUNER] before pressing [POWER] when turning the power of the receiver ON and OFF.

To listen to radio broadcasts

To switch the remote control transmitter to tuner operation mode



Be sure to press this button before operating the receiver.

To select the desired channel sequentially (Preset tuning)

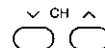

To select the desired channel directly (Preset tuning)

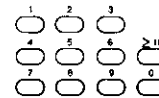

(Example: Channel 1)

(Example: Channel 10)

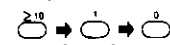

within 10 seconds

To select radio stations by frequency (Direct tuning)

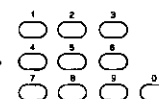

(Example: 107.9 MHz)

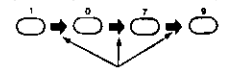

within 10 seconds

To operate CD changers (or CD players)

Turn the CD changer (or CD player) ON before trying to operate it by remote control.

<p>Facing toward the CD changer (or CD player)</p>	<p>To switch the remote control to CD changer (or CD player) operation mode</p>	<p>Be sure to press this button before operating the CD changer or CD player.</p>
	<p>To start play</p>	
	<p>[CD changer only] To start play from the desired disc</p>	<p>For 5 CD changer</p> <p>Select disc number.</p>
		<p>For MEGA CD changer ※</p> <p>Select disc number. (when selecting discs, the [≥10] button does not respond touch.)</p>
		<p>For your reference</p> <p>If you press this button instead of the [▶] button shown in the above procedure, the CD changer will stop and display the disc number. To start the disc, press [▶].</p>
	<p>To start play from the desired track</p>	<p>(Example: Track 1) (Example: Track 10)</p>
<p>To skip a track</p>	<p>(Backward) (Forward)</p>	
<p>To stop play</p>		

※ "MEGA CD changer" means any Technics CD changer that takes more than 50 discs.

To operate a cassette deck

Turn the cassette deck ON before trying to operate it by remote control.

Operations

<p>Facing toward the cassette deck</p>	<p>To switch the remote control transmitter to cassette deck operation mode</p>	<p>Be sure to press this button before operating the cassette deck.</p>
	<p>Only when using a double cassette deck To select the tape deck (DECK 1/DECK 2)</p>	<p>The remote control indicator of the cassette deck will change each time the button is pressed.</p>
	<p>To start playback</p>	<p>(Reverse) (Forward)</p>
	<p>To fast-forward or rewind the tape</p>	<p>While the tape is stopped</p> <p>With TPS-equipped cassette decks, while the tape is playing, you can move to the beginning or end of a track by pressing these buttons.</p>
	<p>To stop playback</p>	

To watch TV broadcasts

The below procedures are examples for when a TV and VCR are connected as shown in this manual.

	<p>To watch TV broadcasts with just a TV</p>		
	<p>Facing toward the TV</p> <p>Switch ON the power for TV.</p>	<p>Facing toward the TV</p> <p>Set the TV/VIDEO mode on the TV to "TV".</p>	
	<p>Select the desired channel.</p>		
	<p>To watch TV broadcasts with a VCR tuner</p>		
	<p>Facing toward the TV</p> <p>Switch ON the power for TV.</p>	<p>Facing toward the VCR</p> <p>Switch ON the power for VCR.</p>	
<p>Facing toward the TV</p> <p>Set the TV/VIDEO mode on the TV to "VIDEO".</p>	<p>Facing toward the receiver</p> <p>Facing toward the VCR</p> <p>Select the desired channel.</p>		
<p>To switch OFF the power for TV</p>	<p>POWER</p>	<p>To switch OFF the power for VCR</p>	<p>POWER</p>
<p>How to use the antenna input selection button</p> <p>Each time the button is pressed, the antenna input at the VCR changes from "TV" to "VCR" and vice versa.</p>			

Note

Some TVs and VCRs cannot be operated with this remote control.

To watch video tapes

The below procedures are examples for when a TV and VCR are connected as shown in this manual.

	<p>Facing toward the TV</p> <p>TV → POWER</p> <p>Switch ON the power for TV.</p>	<p>Facing toward the VCR</p> <p>VCR → POWER</p> <p>Switch ON the power for VCR.</p>	<p>Set the TV/VIDEO mode on the TV to "VIDEO".</p>	<p>Facing toward the receiver</p> <p>VCR</p> <p>↓</p> <p>Facing toward the VCR</p> <p>▶ Playback will begin.</p>
	<p>To fast-forward or rewind the video tape</p>	<p>In the stop mode</p> <p>VCR → ◀◀◀ ▶▶▶</p>		
	<p>To stop playback</p>	<p>VCR → ■</p>		
	<p>To switch OFF the power for TV</p>	<p>TV → POWER</p>		
	<p>To switch OFF the power for VCR</p>	<p>VCR → POWER</p>		

To operate laser disc player

The below procedures are examples for when a laser disc player is connected to the "VCR"(IN) terminals of the receiver.

	<p>Facing toward the TV</p> <p>TV → POWER</p> <p>Switch ON the power for TV.</p>	<p>Facing toward the laser disc player</p> <p>VDP → POWER</p> <p>Switch ON the power for laser disc player.</p>	<p>Set the TV/VIDEO mode on the TV to "VIDEO".</p>	<p>VCR</p> <p>↓</p> <p>Facing toward the laser disc player</p> <p>▶ Play will begin. ◀ VDP</p>
	<p>To search for the desired position</p>	<p>In the play mode</p> <p>VDP → ◀◀◀ ▶▶▶</p>		
	<p>To stop play</p>	<p>VDP → ■</p>		
	<p>To switch OFF the power for TV</p>	<p>TV → POWER</p>		
	<p>To switch OFF the power for laser disc player</p>	<p>VDP → POWER</p>		

Troubleshooting guide

Before requesting service for this unit, check the chart below for a possible cause of the problem you are experiencing. Some simple checks or a minor adjustment on your part may eliminate the problem and restore proper operation.

If you are in doubt about some of the check points, or if the remedies indicated in the chart do not solve the problem, refer to the directory of Authorized Service Centers (enclosed with this unit) to locate a convenient service center, or consult your dealer for instructions.

For detailed instructions, contact an authorized servicenter in the U.S.A. and Panasonic Canada Inc. Customer Care Centre in Canada.

In the U.S.A. 1-800-211-7262 or web site (<http://www.panasonic.com>)

In Canada 905-624-5505 or web site (www.panasonic.ca)

Reference pages indicated in black circles. (For example: ⑥)

Problem	Probable cause(s)	Suggested remedy
While listening to FM broadcasts		
An unusual hissing noise is heard when listening to the broadcast in stereo, but not heard when listening monaurally.	A slight noise may be heard because the method used for modulation of FM stereo broadcasts is different than that used for monaural broadcasts.	<ul style="list-style-type: none"> Try reducing the treble sound by using the treble control. (⑨) Try changing the location, height and/or direction of the antenna. (⑦ ⑧) If an indoor antenna is being used, change to an outdoor antenna. (⑧) Try using an antenna with more elements.
Noise is excessive in both stereo and monaural broadcasts.	Poor location and/or direction of the antenna. Transmitting station is too far away.	
The FM stereo indicator or the quartz lock indicator flickers, without completely illuminating.	Poor location and/or direction of the antenna. Transmitting station is too far away.	<ul style="list-style-type: none"> Try changing the location, height and/or direction of the antenna. (⑦ ⑧) If an indoor antenna is being used, change to an outdoor antenna. (⑧) Try using an antenna with more elements.
Excessive distortion in the sound of stereo broadcasts.	Nearby building or mountain.	

While listening to AM broadcasts		
An unusual "beat" sound is heard.	Unit is being used at the same time as the television set.	Turn off the television set, or use this unit farther away from it.
	Interference from adjacent broadcast signal.	Try reducing the treble sound by using the treble control. (⑨)
A low-pitched "hum" sound is heard when the broadcast is tuned.	The AM loop antenna connection wires are too close to the power cord.	Place the antenna connection wires and the power cord farther apart.
	The power supply frequency from the power cord is modulated and heard from the speakers.	Install a special outdoor antenna. (⑧)
A strange hissing noise is produced continuously or intermittently.	Caused by the "discharge phenomenon" and the "oscillation phenomenon" of electric appliances (such as fluorescent lights, TV, small series-type motors, rectification equipment, etc.).	Try placing this unit farther away from such equipment.

Common problems		
Power will not switch ON.	The power cord plug is not completely inserted.	Confirm that the power cord plug is connected completely.
No sound is heard.	The speaker indicator is turned off.	Turn on the speaker indicator. (⑨)
	The tape monitor function is ON.	Press the tape monitor button. (⑨)
	The muting function is ON.	Press the muting button. (⑨)
	Connections are incomplete or incorrect to the speaker systems, etc.	Check to be sure that all connection wires are correctly connected. (⑤)
Sound stops during a performance, or no sound is heard when the power is switched ON. (The word "OVERLOAD" appears on the display.)	The incorrect input selector has been pressed.	Check to be sure that the correct selector is pressed. (③)
	The protection circuitry has functioned because the positive and negative speaker connection wires are "shorted," speaker systems with an impedance less than the indicated rated impedance of this unit are used or under severe use, such as loud volume, excessive power and in an excessively hot environment.	<ul style="list-style-type: none"> Switch off the power, and after determining and correcting the cause, switch on the power once again. Use a speaker system of the proper impedance rating. (⑥)

Listening caution



Selecting fine audio equipment such as the unit you've just purchased is only the start of your musical enjoyment. Now it's time to consider how you can maximize the fun and excitement your equipment offers. This manufacturer and the Electronic Industries Association's Consumer Electronics Group want you to get the most out of your equipment by playing it at a safe level. One that lets the sound come through loud and clear without annoying blaring or distortion-and, most importantly, without affecting your sensitive hearing.

We recommend you to avoid prolonged exposure to excessive noise.

Sound can be deceiving. Over time your hearing "comfort level" adapts to higher volumes of sound. So what sounds "normal" can actually be loud and harmful to your hearing.

Guard against this by setting your equipment at a safe level BEFORE your hearing adapts.

To establish a safe level:

- Start your volume control at a low setting.
- Slowly increase the sound until you can hear it comfortably and clearly, and without distortion.

Once you have established a comfortable sound level:

- Set the dial and leave it there.

Taking a minute to do this now will help to prevent hearing damage or loss in the future. After all, we want you listening for a lifetime.

Maintenance

To clean this unit, wipe with a soft, dry cloth.

If the surfaces are extremely dirty, use a soft cloth dipped in a soap-and-water solution or a weak detergent solution.

- Never use alcohol, paint thinner or benzine to clean this unit.
- Before using chemically treated cloth, read the instructions that came with the cloth carefully.

Product service

Do not attempt to remove the cover(s) or repair the unit yourself. Refer servicing to qualified personnel only.

Product information

For product service, product information or assistance in product operation, refer to the servicer directory.

■ AMPLIFIER SECTION

Rated minimum sine wave	
RMS power output	100 W per channel (8 Ω)
40 Hz–20 kHz both channels driven	
0.8% total harmonic distortion	
1 kHz continuous power output	103 W per channel (8 Ω)
both channels driven	
0.8% total harmonic distortion	
Total harmonic distortion	
rated power at 40 Hz–20 kHz	0.8% (8 Ω)
half power at 1 kHz	0.07% (8 Ω)
Low frequency damping factor	30 (8 Ω)
Load impedance	
A or B	8 Ω
Dynamic headroom	2 dB (8 Ω)
SMPTE intermodulation distortion	0.3%
Frequency response	
PHONO	RIAA standard curve ±0.8 dB
CD, TAPE, VCR	10 Hz–70 kHz, ±3 dB
Input sensitivity	
PHONO	0.4 mV (3 mV, IHF'66)
CD, TAPE, VCR	27 mV (200 mV, IHF'66)
S/N (IHF A)	
PHONO	70 dB (78 dB, IHF'66)
CD, TAPE, VCR	75 dB (83 dB, IHF'66)
Input impedance	
PHONO	47 kΩ
CD, TAPE, VCR	22 kΩ
Tone controls	
BASS	50 Hz, +10 to –10 dB
TREBLE	20 kHz, +10 to –10 dB

■ FM TUNER SECTION

Frequency range	87.9–107.9 MHz
Sensitivity	11.2 dBf (2 μV, IHF'58)
50 dB quieting sensitivity	
MONO	18.3 dBf (4.5 μV, IHF'58)
STEREO	38.3 dBf (45 μV, IHF'58)
Total harmonic distortion	
MONO	0.2%
STEREO	0.3%
S/N	
MONO	75 dB
STEREO	70 dB
Frequency response	20 Hz–15 kHz, +1 dB, –2 dB
Alternate channel selectivity	65 dB
Capture ratio	1 dB
Image rejection at 98 MHz	44 dB
IF rejection at 98 MHz	80 dB
Spurious response rejection at 98 MHz	75 dB
AM suppression	
STEREO separation	50 dB
1 kHz	40 dB
10 kHz	30 dB
Carrier leak	
19 kHz	–35 dB
38 kHz	–50 dB
Antenna terminal	75 Ω (unbalanced)

■ AM TUNER SECTION

Frequency range	530–1710 kHz
Sensitivity	20 μV, 330 μV/m
Selectivity	55 dB
Image rejection at 1000 kHz	40 dB
IF rejection at 1000 kHz	60 dB

■ GENERAL

Power supply	AC 120 V, 60 Hz
Power consumption	155 W
Dimensions (W×H×D)	430×136×312 mm (16-15/16"×5-11/32"×12-9/32")
Weight	6.4 kg (14.1 lb.)

Power Consumption in standby mode: 2 W

Notes:

- Specifications are subject to change without notice. Weight and dimensions are approximate.
- Total harmonic distortion is measured by the digital spectrum analyzer.

Panasonic Consumer Electronics
Company, Division of Matsushita
Electric Corporation of America
One Panasonic Way Secaucus,
New Jersey 07094
<http://www.panasonic.com>

Panasonic Sales Company,
Division of Matsushita Electric of
Puerto Rico, Inc. ("PSC")
Ave. 65 de Infantería. Km. 9.5
San Gabriel Industrial Park, Carolina,
Puerto Rico 00985

Panasonic Canada Inc. 
5770 Ambler Drive,
Mississauga, Ontario
L4W 2T3
www.panasonic.ca