

GX-600DB

STEREO TAPE DECK

OPERATOR'S MANUAL

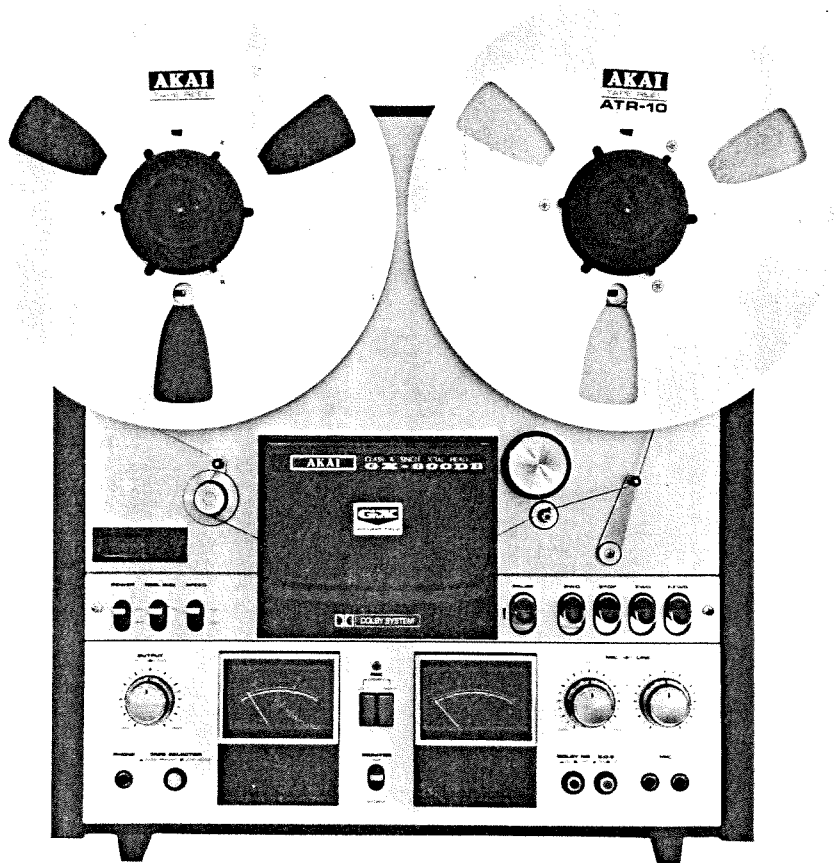

THIS MANUAL IS ALSO APPLICABLE TO MODEL GX-600D
STEREO TAPE DECK

AKAI®

MANUFACTURED & DISTRIBUTED BY AKAI ELECTRIC CO., LTD./AKAI TRADING CO., LTD./AKAI AMERICA LTD.

CEE, CSA, and UL Standard models are not equipped with a Voltage Selector and cycle conversion apparatus. Therefore, voltage and cycle conversion is not necessary. If your machine corresponds to any of these standards, please disregard all references to voltage and cycle adjustment throughout this manual.

CEE Models: 220 V, 50 Hz.

CSA Models: 120 V, 60 Hz.

UL Models: 120 V, 60 Hz.

INDEX

Controls	2
Operating precautions	4
4-Track stereo recording and playback system	4
4-Track monaural recording and playback system	4
Tape loading	5
Tape speed selection	5
Dolby noise reduction system	5
Sound monitoring	6
Connections for playback	7
Playback	8
Connections for recording	9
Recording	10
Sound-on-sound recording	11
Sound mixing	11
Tape erasing	11
Tape splicing and editing	11
Head block cleaning	12
Head demagnetizing	12
Voltage and cycle conversion	13
Standard accessories	14
Technical data	14
Trouble shooting chart	15

CONTROLS

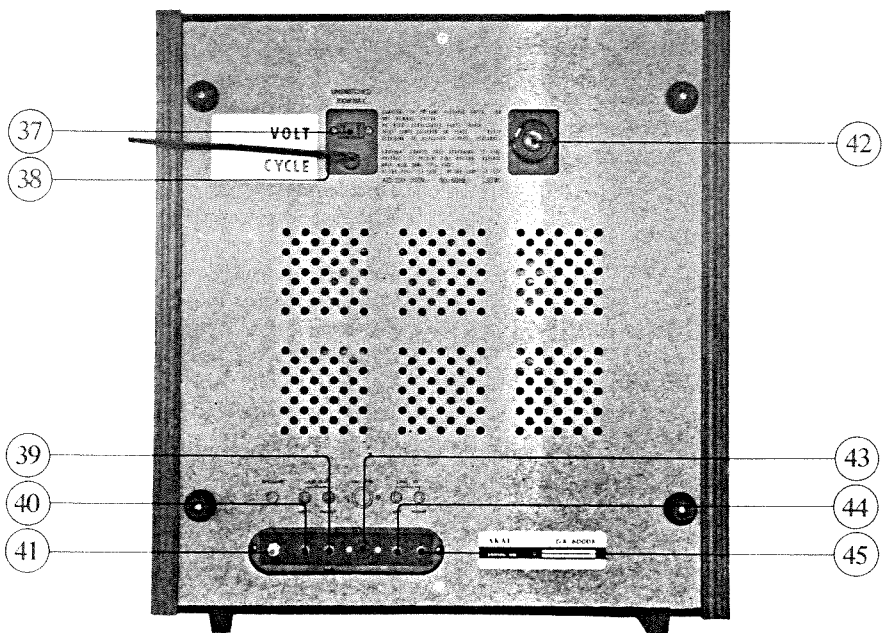
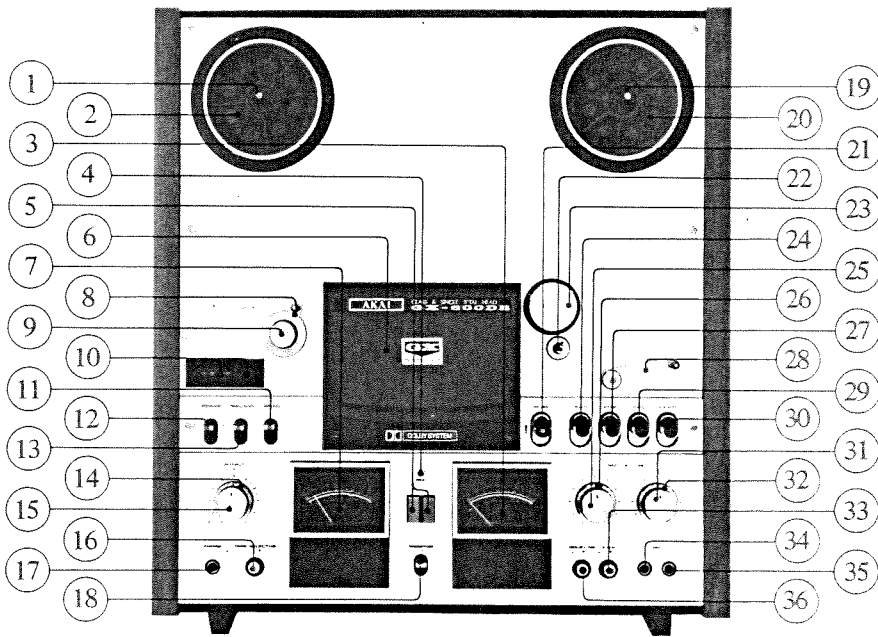

1. BUILT-IN REEL RETAINER (left)
To lock reel firmly into place, pull tip of retainer outward and turn to left or right.
2. SUPPLY REEL TABLE
3. VU METER (right)
Indicates right channel recording and playback levels.
4. RECORDING INDICATOR LAMP
Lights to indicate recording mode.
5. RECORDING SWITCHES
STEREO MODE: While holding both Recording Switches at depressed position, depress FWD Key.
MONAURAL MODE: While holding left or right channel Recording Switch at depressed position, depress FWD Key.
6. HEAD COVER
Houses head block including GX recording, GX playback, and erase heads.
7. VU METER (left)
Indicates left channel recording and playback levels.
8. TAPE TENSION LEVER
Provides ideal tape tension.
9. IMPEDANCE ROLLER
10. INDEX COUNTER AND RESET BUTTON
11. SPEED SELECTOR SWITCH
HIGH: 7-1/2 ips; Low: 3-3/4 ips.
12. POWER SWITCH
13. REEL SIZE SELECTOR
Set to "10" when using 10-1/2" reels and to "7" when using 7" or 5" reels.
14. OUTPUT LEVEL CONTROL (right)
Adjusts right channel output level during playback.
15. OUTPUT LEVEL CONTROL (left)
Adjusts left channel output level during playback.
16. TAPE SELECTOR SWITCH
WIDE RANGE (In): Set to this position when using Wide Range Tape.
LOW NOISE (Out): Set of this position when using Low Noise Tape.
* Scotch #211 Low Noise Tape is considered standard for this machine. The use of regular tape is not recommended.
* Set to Wide Range position only when using special wide range tape of a grade higher than low noise tape.
17. HEADPHONE JACK
Accommodates 8Ω impedance type stereo headphones for monitoring or private headphone listening.
18. MONITOR SWITCH
Set to SOURCE position to monitor source, and to TAPE position for playback.
19. BUILT-IN REEL RETAINER (right)
To lock reel firmly into place, pull tip of retainer outward and turn to left or right.
20. TAKE-UP REEL TABLE
21. PAUSE KEY
Depress to temporarily suspend tape travel during recording or playback. Especially convenient for editing tape. Simply depress when a certain portion of the program is not desired.
* Pause release is automatically effected when a control key is depressed.
* Pause Control does not function during Fast Forward or Rewind.
22. CAPSTAN
23. PINCH WHEEL
Presses against capstan to transport tape.
24. REWIND KEY
Rewinds tape at high speed.
* Use Stop Key to stop rewind mode. (Direct function change to Forward mode cannot be accomplished).
25. MICROPHONE INPUT LEVEL CONTROL (left)
Controls left channel microphone input volume. Adjust while observing left channel VU Meter.
26. LINE INPUT LEVEL CONTROL (left)
Controls left channel line input volume. Adjust while observing left channel VU Meter.
27. STOP KEY
28. AUTOMATIC STOP/TAPE TENSION LEVER
At the end of the tape when this lever drops, the automatic stop circuit is activated and reel movement is stopped. This lever also functions as a tension arm to provide ideal tape tension.
29. FORWARD KEY
Advances tape for recording or playback mode.
30. FAST FORWARD KEY
Advances tape at high speed.
* Use Stop Key to stop fast forward mode. (Direct function change to Forward mode cannot be accomplished).
31. MICROPHONE INPUT LEVEL CONTROL (right)
Controls right channel microphone input volume. Adjust while observing right channel VU Meter.
32. LINE INPUT LEVEL CONTROL (right)
Controls right channel line input volume. Adjust while observing right channel VU Meter.
33. SOUND-ON-SOUND SWITCH
Refer to SOUND-ON-SOUND RECORDING procedure.
* Keep the S.O.S. Switch at OFF (out position) except as described in Sound-On-Sound procedure.
34. MICROPHONE JACK (left)
35. MICROPHONE JACK (right)
36. DOLBY NOISE REDUCTION SWITCH (Model GX-600DB)
Set to ON (in) position for Dolby process recording or when playing back a Dolby process recorded tape.
* Keep the Dolby NR Switch at OFF (out) position at all other times.
37. AC OUTLET
Extra AC outlet for added convenience. This is an unswitched outlet (not interlocked with the Power Switch) so that power is supplied to the connected unit even with the GX-600D (DB) turned off.
38. AC CORD
39. LINE OUTPUT JACK (right)
40. LINE OUTPUT JACK (left)
41. GROUND TERMINAL
If hum or clicking noise exists, ground this terminal with the ground terminal of your amplifier.
42. VOLTAGE SELECTOR & FUSE POST
Refer to VOLTAGE AND CYCLE CONVERSION procedure, page 13.
43. DIN JACK
Enables inter-connection with an external amplifier through a single Din Cord.
* When using the Din Jack, input is adjusted with the Microphone Input Level Controls.
44. LINE INPUT JACK (left)
45. LINE INPUT JACK (right)

OPERATING PRECAUTIONS

- * Your machine requires constant voltage for optimum performance. If voltage and cycle change is necessary, refer to VOLTAGE AND CYCLE CONVERSION procedure on page 13.
- * As dirty or magnetized heads become the source of loss of sound, sound drop-out, distortion, and other recording and playback failures, the heads should be kept clean and demagnetized at all times.
- * Place machine on a flat level surface and operate in either a vertical or horizontal position.
- * Do not place anything on top of the unit which will obstruct the ventilator.
- * If the sound sources are so far away from the microphones that the input level controls must be turned to maximum, some hum or noise will inevitably be

recorded. A test recording is recommended before making a final recording.

- * Scotch #211 Low Noise Tape is considered standard for this machine. The use of regular tape is not recommended.
- * Set to Wide Range position only when using special wide range tape of a grade higher than low noise tape.
- * As tapes which have not been used for a period of time may have become sticky, run tape once before using.
- * Always store tapes in a cool, dry place.

Should there be a problem with your machine, write down the model and serial numbers and all pertinent data regarding warranty coverage as well as a clear description of the existing trouble and contact your nearest authorized Akai Service Station or the Service Department of Akai Company, Tokyo, Japan.

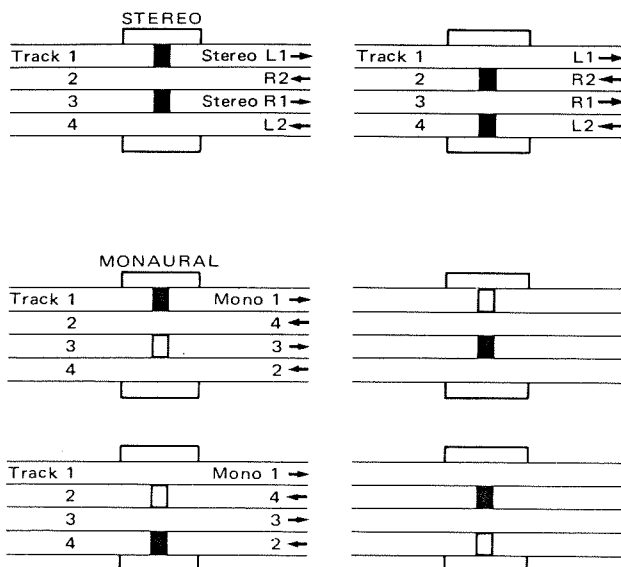

4-TRACK STEREO RECORDING AND PLAYBACK SYSTEM

Stereo recording requires the simultaneous use of two tracks. For stereo operation, depress both Recording Switches. The first stereo recording takes place on tracks 1 and 3, and the second on tracks 2 and 4 after the reels have been inverted.

The first stereo playback takes place on tracks 1 and 3, and the second on tracks 2 and 4 after the reel have been inverted.

4-TRACK MONAURAL RECORDING AND PLAYBACK SYSTEM

4-track monaural recording sequence is 1-4-3-2. For monaural operation, depress the left Recording Switch. The first recording takes place on track 1 and second on track 4 after the reels have been inverted.

For recording on Tracks 3 and 2, depress the right Recording Switch. The third recording takes place on track 3, and the fourth on track 2 after the reels have been inverted.

4-track monaural playback sequence is also 1-4-3-2, but if monaural recordings have been made on both the left and right channels of the tape, set the left or right Output Level Control to minimum at playback time so that only the desired channel is audible.

- * Do not depress the Recording Switches for playback.

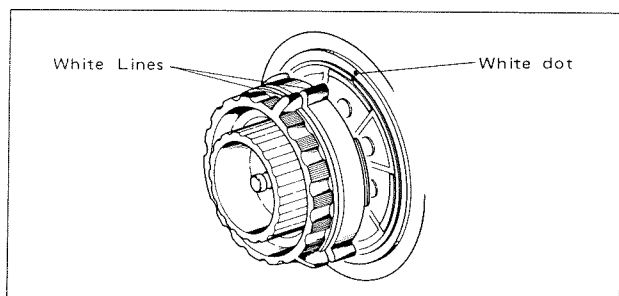
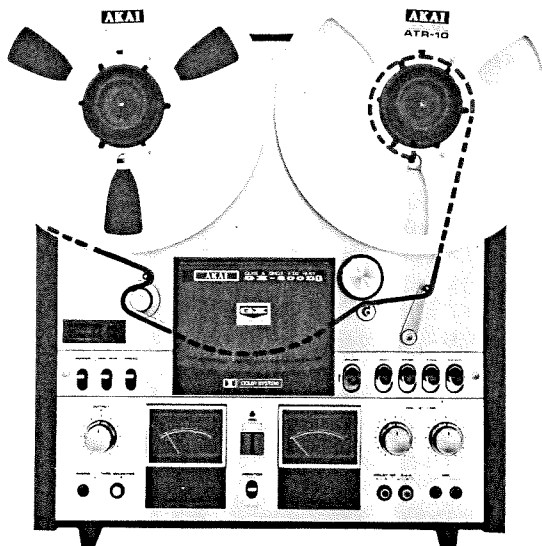

TAPE LOADING

1. Place a full reel of tape on the supply reel table and an empty reel on the take-up reel table.
2. Lock both reels into place by pulling tip of reel retainers outward and turning to left or right.
3. Unwind about an 85 cm length of tape from the supply reel and thread the tape as shown by the dotted lines in the figure.
4. Insert end of tape in slot of empty reel and wind around reel hub two or three times.
5. Continue winding tape onto take-up reel until all slack has been taken up.

When using 10½" reels, place the standard accessory reel adapter hubs on the left and right reel tables and lock into place by pulling tip of reel retainers outward and turning to left or right.

When using 10½" plastic reels

Fit hubs over reel tables so that the white lines on the inner and outer adapter hubs are aligned and match these lines with the dot on reel table.

When using 10½" metallic reels

Fit hubs over reel tables so that the white lines on the inner and outer adapter hubs are aligned, but do not match with dot on reel table. (This provides the necessary spacing for the difference in plastic and metal reel thickness).

TAPE SPEED SELECTION

This model can be operated at HIGH (7½ ips) or LOW (3¾ ips) tape speed. Stereo recording time using an 1800 ft. tape is 3 hours at 3¾ ips and 1.5 hours at 7½ ips. (6 hours at 3¾ ips and 3 hours at 7½ ips for monaural).

DOLBY NOISE REDUCTION SYSTEM (Model GX-600DB only)

The inclusion of the well known Dolby Noise Reduction circuit in this model complements the characteristics of the GX Heads for clear sound reproduction. Depressing the Dolby NR Switch to ON position activates the Dolby circuit to expand low level signals before they are recorded and lowers them by precisely the same amount during playback, thus reducing the extraneous and super-imposed noise by as much as 10 dB for the reduction of tape hiss to an inaudible level.

* When playing back a Dolby recorded tape, the Dolby NR Switch must be set to ON position.

SOUND MONITORING

For private headphone listening, connect stereo headphones and set the Monitor Switch to TAPE position.

For more precise recording level adjustment, set Monitor Switch to SOURCE position and monitor signals through headphones while adjusting input level controls.

Dual monitoring for a more professional recording can also be accomplished by switching the Monitor Switch to and from TAPE and SOURCE to compare the signals being recorded with the input source.

- * Set Monitor Switch to TAPE position for playback through a speaker system.
- * Monaural headphone listening cannot be accomplished if different monaural recordings have been made on both the left and right channels of the tape (Signals from both channels are heard through headphones).

CONNECTIONS FOR PLAYBACK

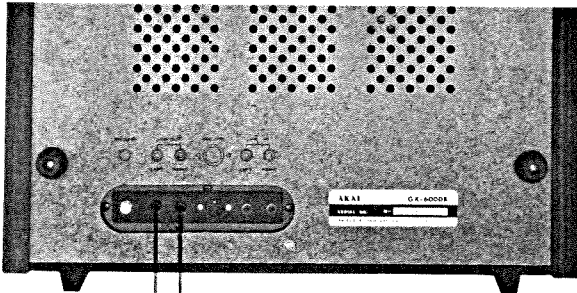

The Din Jack can be used instead of the Line Input/Output Jacks for connection with an external amplifier. This enables recording and playback with a single Din Connection Cord.

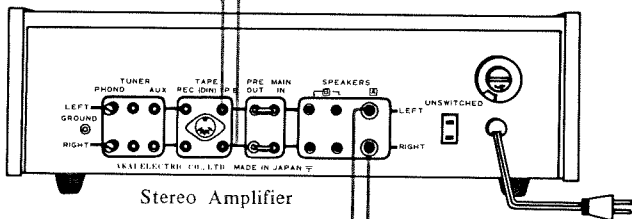

Stereo Amplifier

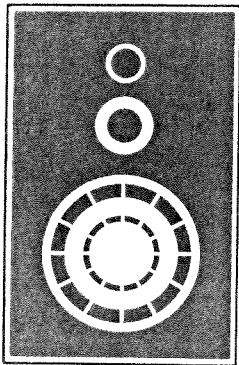

SPEAKER

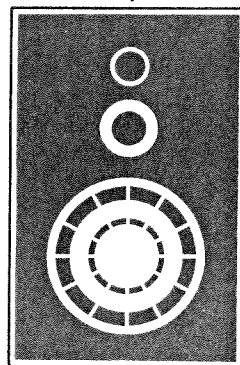

SPEAKER

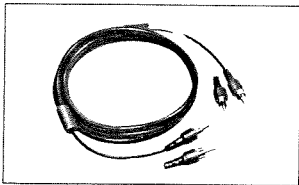

RCA/RCA
Connection Cord

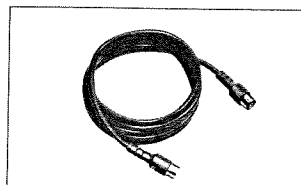

DIN/DIN
Connection Cord

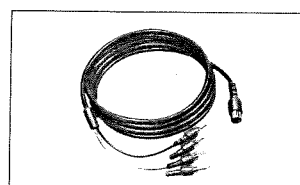

DIN/RCA
Connection Cord

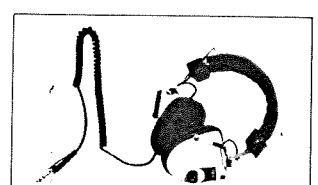

For private headphone listening, use stereo headphones of 8 Ω impedance.

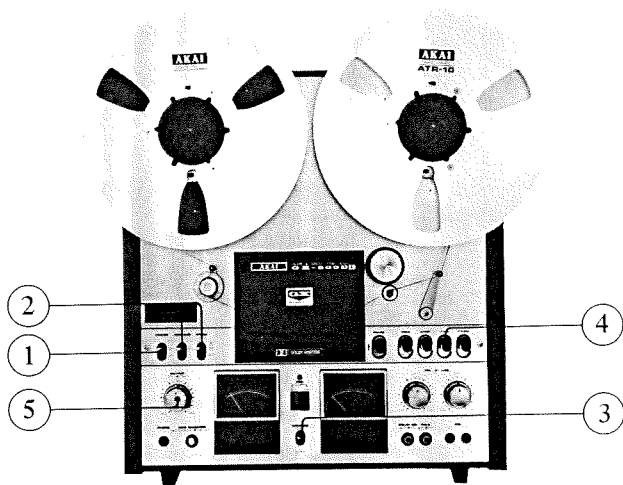

PLAYBACK

Make necessary connections as shown in CONNECTIONS FOR PLAYBACK and load a prerecorded tape.

Stereo Playback

1. Connect power cord and turn on Power Switch.
2. Set Reel Size Selector according to size of reel being used and select tape speed.
3. Set Monitor Switch to TAPE POSITION.
4. Depress FWD Key to begin playback.
5. Adjust left and right Output Level Controls and amplifier controls.
6. Invert reels for playback of tracks 3-2.

Monaural Playback

Monaural playback is effected in the same way as stereo. However, if monaural recordings have been made on both the left and right channels of the tape, at playback time, set the left or right output level control to minimum so that only the desired channel is audible.

* Monaural headphone listening cannot be accomplished if different monaural recordings have been made on both the left and right channels of the tape (Signals from both channels are heard through headphones).

CONNECTIONS FOR RECORDING

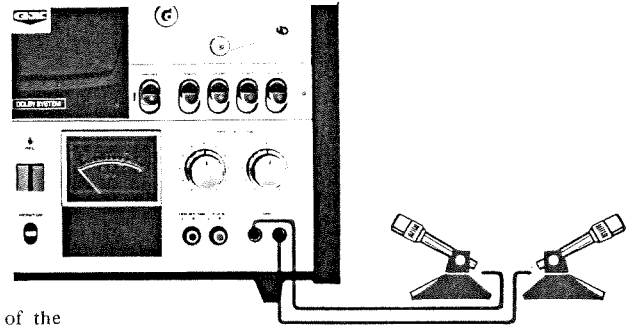
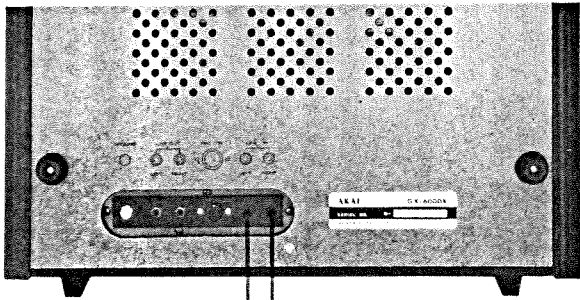

The Din Jack can be used instead of the Line Input/Output Jacks for connection with an external amplifier. This enable recording or playback with a single connection cord. In this case, the input level is adjusted with the Microphone Level Controls.

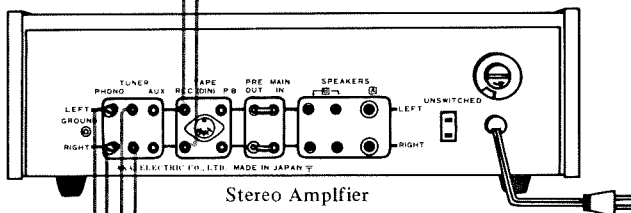

Stereo Amplifier

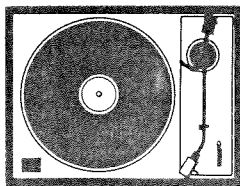

Magnetic cartridge turntable



Stereo tuner

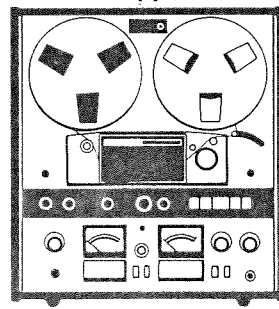

Stereo tape deck or recorder. Do not use Din-Din connection.

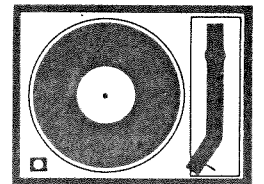

Crystal or ceramic cartridge turntable

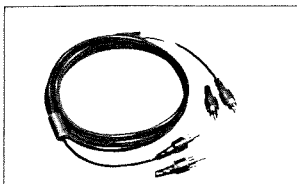

RCA/RCA Connection Cord

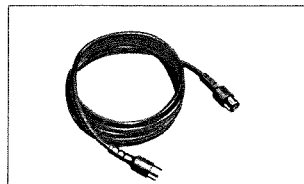

DIN/DIN Connection Cord

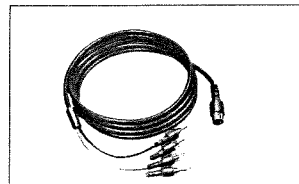

DIN/RCA Connection Cord

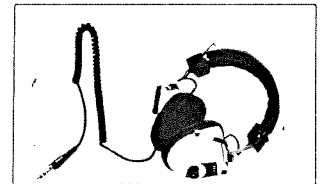

For monitoring use stereo headphones of 8 Ω impedance.

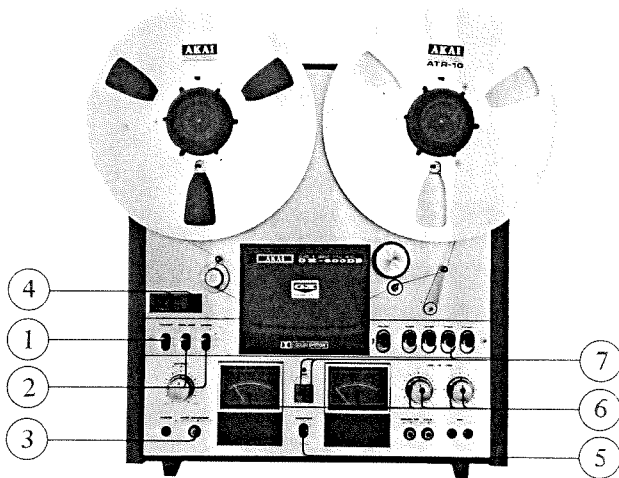

RECORDING

Make necessary connections as shown in CONNECTIONS FOR RECORDING and load a tape.

Stereo Recording

1. Connect power cord and turn on Power Switch.
2. Set Reel Size Selector according to size of reel being used and select tape speed.
3. Set Tape Selector according to kind of tape being used.
4. Set Index Counter to "0000". (Provides an easy reference for locating positions on the tape).
5. Set Monitor Switch to SOURCE position.
6. Adjust and balance input level with corresponding Recording Level Controls while observing the VU Meters. (Normal recording should not exceed 0 VU on either meter).
7. When an optimum recording level has been determined, while holding both left and right Recording Switches at depressed position, depress FWD Key to begin recording. (The Recording Indicator Lamp will light to indicate recording mode).
8. Invert reels for recording on tracks 3-2.

Monaural recording

For monaural recording, substitute the following steps for steps 6, 7, and 8 of Stereo Recording procedure.

Tracks 1 and 4

Only the left channel is used for monaural recording on tracks 1 and 4.

6. Adjust and balance input level with corresponding left Recording Level Control while observing the left VU Meter. (Normal recording should not exceed 0 VU).
7. When an optimum recording level has been determined, while holding the left Recording Switch at depressed position, depress FWD Key to begin recording. (The Recording Indicator Lamp will light to indicate recording mode).
8. Invert reels for recording on track 4.

Tracks 3 and 2

Only the right channel is used for monaural recording on tracks 3 and 2.

6. Adjust and balance input level with corresponding right Recording Level Control while observing the right VU Meter. (Normal recording should not exceed 0 VU).
7. When an optimum recording level has been determined, while holding the right Recording Switch at depressed position, depress FWD Key to begin recording. (The Recording Indicator Lamp will light to indicate recording mode).
8. Invert reels for recording on track 2.

SOUND-ON-SOUND RECORDING

For transfer of previously recorded material from one track to another, accumulating as many individual recordings on a single track as is desired. Use for professional musical compilations or for fun.

First recording

1. Confirm that there are no connections to the Input Jacks and turn all input level controls to minimum.
2. Plug in microphone to left Microphone Jack.
3. Set Monitor Switch to SOURCE position.
4. Adjust left Microphone Recording Level Control while observing the left VU Meter.
5. Set Index Counter to "0000".
6. While holding left Recording Switch at depressed position, depress FWD Key to begin first recording.
7. When recording is completed, rewind tape to starting point.

Second recording

8. Confirm that the Monitor Switch is at SOURCE position and set Sound-On-Sound Switch to ON position.
9. Plug in microphone to right Microphone Jack.
10. Connect stereo headphones to Headphone Jack for monitoring the first recording.
11. Adjust right Microphone Recording Level Control while observing the right VU Meter.
12. Turn up right Line Recording Level Control to same position as right Microphone Recording Level Control.
13. While holding right Recording Switch at depressed position, depress FWD Key to begin second recording.

* As the second recording is being made, the first recording is monitored through the headphones. The two recordings will be completely merged on the right channel tracks.

* Third and subsequent recordings are made in the same manner as the second by switching left and right Recording Switches. Note that the Line Recording Level Control not in immediate use must be set to minimum during recording. For instance, when making the second recording, the left Line Recording Level Control must be set to minimum and the right control to maximum or the same level as the microphone input. When effecting the third recording, the right Line Recording Level Control must be set to minimum, and the left Line Recording Level Control turned up, etc.

* For playback, set Monitor Switch to TAPE position and set the left or right Output Level Control to minimum so that only the track on which the last recording was made is audible.

* Private headphone listening of SOS playback cannot be accomplished as signals from both tracks are heard through headphones.

SOUND MIXING

Another important feature of this model is the built-in microphone-line mixing circuit. Independent line and microphone recording level controls and input jacks enable signals from microphones and from line sources to be blended and recorded simultaneously on the tape.

Connect microphones to Microphone Jacks and connect desired source to the Line Input Jacks. Follow recording procedure, adjusting both Line and Microphone Input Level Controls.

* Line and Din mixing can also be accomplished. In this case, Din input level is adjusted with Microphone Input Level Controls.

TAPE ERASING

Any signals previously recorded on the tape will be automatically erased as a new recording is made. For erasing only, thread the tape and set machine to recording mode. No plugs should be connected to the input jacks and the input level controls should be kept at minimum. For quick and complete erasure, a bulk tape eraser is recommended.

* Be sure to depress the proper Track Selector Switch(es). If both switches are depressed, both the left and right channels will be erased.

TAPE SPLICING AND EDITING

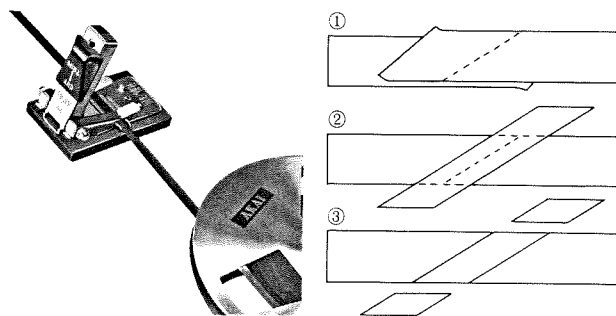

Cut the tape diagonally with an overlap so that the ends are lined up. Cutting tape on the diagonal eliminates detection of the splice in recording. Cover aligned ends with splicing tape, exerting pressure to secure ends evenly. Trim off excess splicing tape. Cutting into magnetic tape very slightly will eliminate the possibility of a sticky splice. Splicing using scissors requires skillful work. For smooth and easy splicing, Akai Tape Splicer AS-3 is highly recommended.

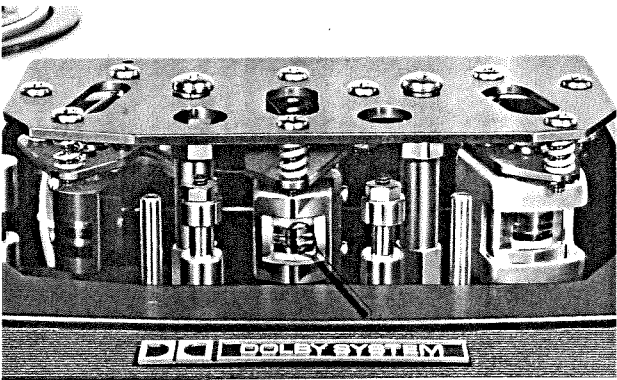

HEAD BLOCK CLEANING

Heads

The GX (glass and single crystal) Heads do not require a great deal of cleaning. However, if old tapes or tapes which have been spliced are used, GX head cleaning is also recommended.

Clean recording, playback, and erase heads with a cotton swab stick which has been dipped in Akai Cleaning fluid from Head Cleaning Kit HC-500.

Pinch wheel and capstan

If foreign matter is allowed to accumulate on the pinch wheel and capstan, these particles will come off on the tape causing deterioration of sound quality. Oil adhering to the capstan also causes irregularity in tape transport. Therefore, it is also recommended that these parts be wiped clean periodically. Use Akai cleaning fluid or alcohol.

* Do not use chemicals such as chlorothane, etc. for head block cleaning as the rubber parts will deteriorate.

HEAD DEMAGNETIZING

Prolonged use of the machine will gradually build up residual magnetism on the heads. The effect of magnetization is that it causes a considerable drop in high frequency response and introduces noise into your recordings. It is therefore, recommended that head demagnetizing be performed periodically. This can be accomplished with a bulk head demagnetizer by bringing the prongs of the demagnetizer close to the heads and making several small circular motions over all head surface areas as well as the head housing.

- * Turn off the power of the unit prior to demagnetizing the heads.
- * Do not use magnetized tools in the vicinity of the heads and VU Meters.
- * Do not bring the magnetizer close to the VU Meters.

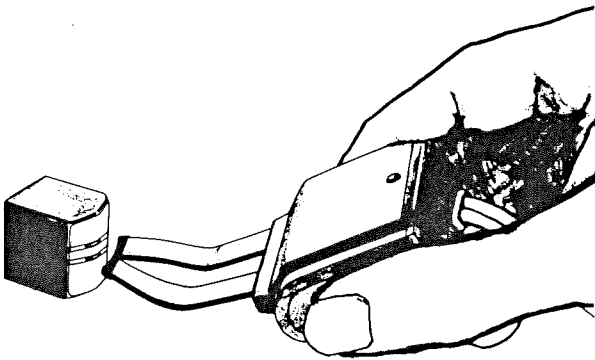

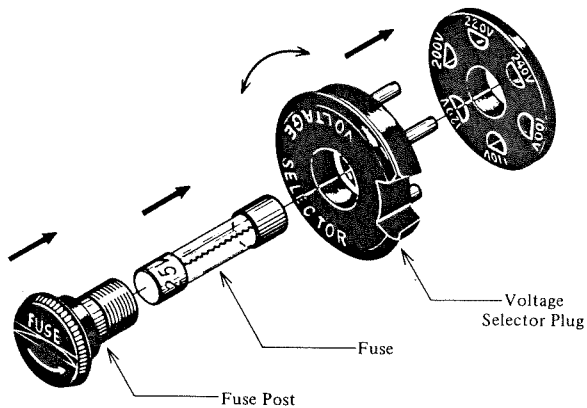

VOLTAGE AND CYCLE CONVERSION

When changing voltage, it is also necessary to change cycles accordingly. Because cycle change is difficult, it is recommended that your machine be taken to your nearest Akai Service Agent if voltage and cycle change is necessary. However, as certain customers strongly feel that they are qualified to perform this service themselves, voltage and cycle change procedure is outlined below:

VOLTAGE

Your machine is equipped with a universal voltage selector offering six selections of voltage from 100V to 240V AC for worldwide operation. Voltage is preset at the factory according to destination. If voltage change is necessary, conversion can be accomplished as follows:

- A. Disconnect power cord and remove the Fuse Post by screwing in direction of arrow.
- B. Remove the Voltage Selector Plug and reinsert so that proper area voltage shows through the plug cut-out.
- C. Change fuse to correspond with voltage and tighten fuse post.

* 100V to 120V: 2 A, 125V fuse; 200 to 240V: 1 A to 250V fuse.

* To maintain optimum performance and prolong the life of your machine, it is important that the line voltage be held within a 10% deviation of standard area voltage.

CYCLES

Correct tape speed cannot be attained if the Cycle Conversion Switch and drive belt are not properly positioned. However, as this necessitates removal of the rear panel, the customer must assume full responsibility should he choose to perform this service himself or if this service is performed by anyone other than authorized Akai Service personnel.

1. Disconnect power cord and remove rear panel.
2. For 60 Hz operation, set Cycle Conversion Switch to 60 Hz position and position drive belt to run on larger pulley of flywheel.

For 50 Hz operation, set Cycle Conversion Switch to 50 Hz position and position drive belt to run on smaller pulley of flywheel.

- * Proper operation cannot be attained unless the belt is set to run on flywheel perfectly smoothly.
- * Be sure to disconnect power cord before attempting to remove rear panel.

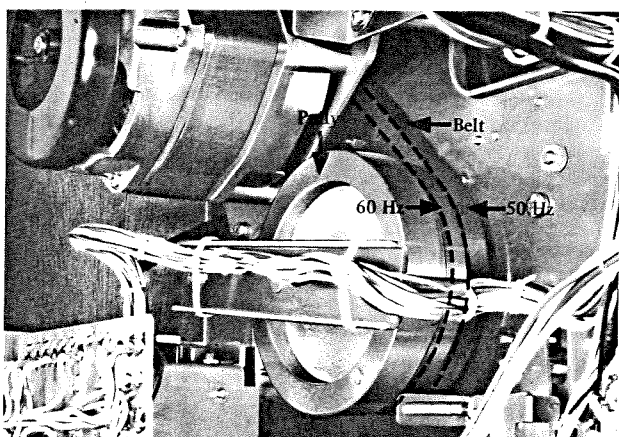
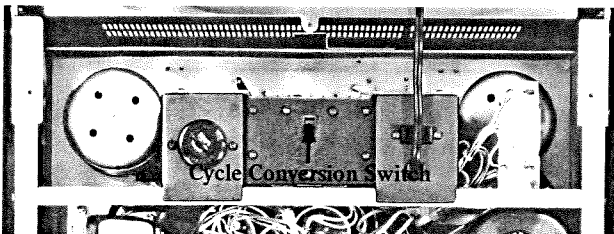

TROUBLE SHOOTING CHART

The conditions listed below do not indicate mechanical failure of your unit. If your machine exhibits any of these conditions, check for trouble as indicated.

SYMPTOM	TROUBLE	REMEDY
Loss of sensitivity and tone quality.	<ul style="list-style-type: none"> * Dirty Erase Head. * Wrong side of tape facing the heads. * A.C. power lower than the voltage to which your machine is adjusted. * Magnetized head. * Tape Selector Switch is set incorrectly. 	<ul style="list-style-type: none"> * See HEAD BLOCK CLEANING. * See VOLTAGE & CYCLE CONVERSION. * See HEAD DEMAGNETIZING.
Machine will not record or playback.	<ul style="list-style-type: none"> * Check positions of controls and input/output. * Check position of the Recording Switches. * Check position of the Automatic Stop/Tape Tension Lever * Output Level Control at minimum. 	
Irregularity in tape transport.	<ul style="list-style-type: none"> * Oil or magnetic particles adhering to the Capstan or Pinch Wheel. * Sticky or dirty tape surface. * Improperly loaded tape. * A.C. power lower than the voltage to which your machine is adjusted. 	<ul style="list-style-type: none"> * See HEAD BLOCK CLEANING. * See TAPE LOADING. * See VOLTAGE & CYCLE CONVERSION
Tape will not run.	<ul style="list-style-type: none"> * Blown fuse. * Power is not being supplied. * Twisted or sticky tape. 	<ul style="list-style-type: none"> * Check power cord, Power Switch, and Automatic Stop/Tape Tension Lever
Previously recorded program will not erase.	<ul style="list-style-type: none"> * Erase head is dirty. 	<ul style="list-style-type: none"> * See HEAD BLOCK CLEANING.
Distorted or noisy sound.	<ul style="list-style-type: none"> * Recording level is too high. * Check external source controls and connections. 	<ul style="list-style-type: none"> * Normal recording level is zero VU.

STANDARD ACCESSORIES

Pin plug connection cord	1
10-1/2" reel hub adapters	2
Spare fuses	1 set
Operator's manual	1

* "DOLBY" and the Double D symbol are Trade Marks of Dolby Laboratories, Inc.

* Made under license from Dolby Laboratories, Inc.

TECHNICAL DATA

Track System	4 track 2 channel stereo/monaural system
Reel Capacity	Up to 10-1/2" reel
Tape Speed	7-1/2 and 3-3/4 ips (+0.8%)
Wow & Flutter	Less than 0.07% RMS at 7-1/2 ips Less than 0.10% RMS at 3-3/4 ips
Frequency Response	30 Hz to 23,000 Hz (± 3 dB) at 7-1/2 ips 30 Hz to 19,000 Hz (± 3 dB) at 3-3/4 ips
Distortion	Less than 0.7% (1000 Hz "0" VU) at 7-1/2 ips
Signal to Noise Ratio	Better than 56 dB (GX-600DB: with Dolby Process: 64 dB)
Erase Ratio	Better than 70 dB
Cross-Talk	Better than 60 dB (monaural) Better than 40 dB (stereo)
Bias Frequency	150k Hz
Heads	(3): One GX Recording Head, One GX Playback Head, One Erase Head
Motors	(3): One Hysteresis synchronous Capstan Motor, Two eddy-current outer-rotor motors
Fast Forward & Rewind Time	120 sec.
Output Jacks	Line(2): 0.775 V ("0" VU)/100 Ω (Required load impedance: more than 20 k Ω) Phone(1): 30 mV/8 Ω
Input Jack	Microphone(2): 0.3 mV/4.7 k Ω Line(2): 70 mV
Din Jack	0.5 V/3 mV
Semi-Conductors	Transistors: 25 (GX-600D), 53 + FET(4) (GX-600DB) Diodes: 16 (GX-600D), 40 (GX-600DB)
Power Requirements	100 V to 240 V A.C., 50/60 Hz
Power Consumption	130 W/50 Hz. 100 W/60 Hz
Dimensions	443(W) x 475(H) x 228(D)mm (17.4 x 18.7 x 9")
Weight	GX-600D: 22.0 kg (48.4 lbs) GX-600DB: 22.3 kg (49.0 lbs)

* Specifications were determined with SCOTCH #211 (Low Noise) tape.

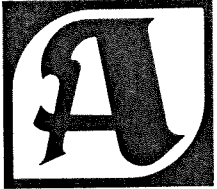

MANUFACTURED & DISTRIBUTED BY
AKAI ELECTRIC CO., LTD.
AKAI TRADING CO., LTD.

12-14, 2-chome, Higashi-Kojiya,
Ohta-ku, Tokyo, Japan

AKAI AMERICA LTD.

2139 E. Del Amo Blvd., Compton, Calif., 90220, U.S.A.

TELEPHONE: (213) 537-3880

TELEX: 67-7494



Printed in Japan