

AKAI SERVICE MANUAL

DT-100
DT-200

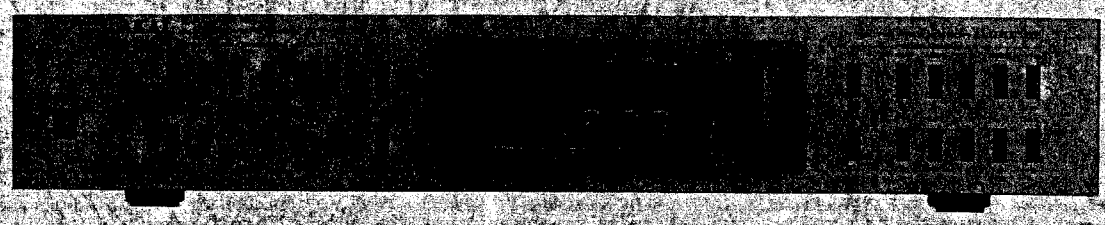
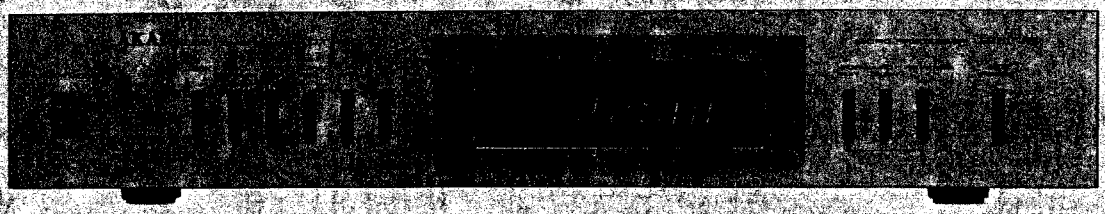

AUDIO-TIMER

DT-100
MODEL **DT-200**

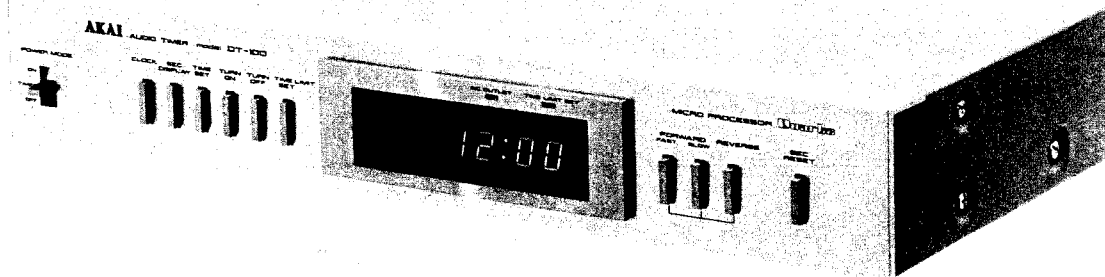

DT-100

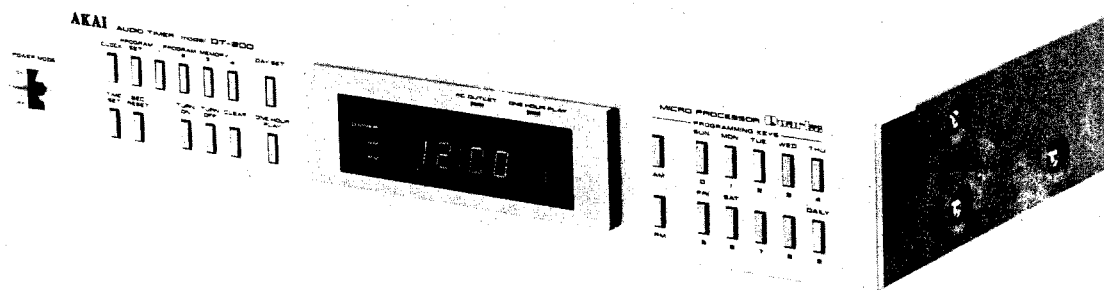

DT-200

AUDIO-TIMER

DT-100
MODEL DT-200

TABLE OF CONTENTS

SECTION 1	SERVICE MANUAL	3
SECTION 2	PARTS LIST	19
SECTION 3	SCHEMATIC DIAGRAM	28

SECTION 1

SERVICE MANUAL

TABLE OF CONTENTS

I.	TECHNICAL DATA.....	4
II.	CONTROLS.....	5
III.	PRINCIPAL PARTS LOCATION.....	7
IV.	EXPLANATION HOW TO USE.....	8
V.	ADJUSTMENT	11
VI.	COMPOSITION OF VARIOUS P.C BOARDS.....	13
	1. MAIN P.C BOARD PCB-4 (DT-100)	13
	2. MAIN P.C BOARD PCB-1-2 (DT-200).....	14
	3. LED P.C BOARD PCB-4 (DT-100/DT-200).....	15

I. TECHNICAL DATA

1. MODEL DT-100

TIMER ACCURACY	±15 seconds within one month
TIMER BASE	Quartz oscillator
TIMER OPERATION ACCURACY	Less than 0.2 seconds
TIMER DISPLAY	24 Hour Display (for certain models) 12/24 Switchable Hour Display (for others)
TIMER SYSTEM	Daily type (turns on and off 2 times.)
TIME SET PERIOD	1 minute to 24 hours
TIME LIMIT	1 minute to 1 hour and 59 minutes
AC OUTLETS	USA, Canada and others: SWITCHED × 2 Total 500W MAX UNSWITCHED × 1 Total 500W MAX UK, Australia and Europe: SWITCHED × 4 Total 600W MAX
POWER REQUIREMENTS	120V, 60 Hz for USA and Canada 110/120/220/240V, 50/60 Hz switchable for the other countries including Europe
POWER CONSUMPTION	9W
DIMENSIONS	440 (W) × 78 (H) × 214 (D) mm (17.3 × 3.1 × 8.4) inches
WEIGHT	2.5 kg (5.5 lbs)

2. MODEL DT-200

TIMER ACCURACY	±15 seconds within one month
TIMER BASE	Quartz oscillator
TIMER OPERATION ACCURACY	Less than 0.2 seconds
TIMER DISPLAY	24 Hour Display (for certain models) 12/24 Switchable Hour Display (for others)
TIMER SYSTEM	Weekly type (Up to 8 operations in one day, turns on and off 4 times.)
TIME SET PERIOD	1 minute to 24 hours
AC OUTLETS	USA, Canada and others: SWITCHED × 2 Total 500W MAX UNSWITCHED × 1 Total 500W MAX UK, Australia and Europe: SWITCHED × 4 Total 600W MAX
POWER REQUIREMENTS	120V, 60 Hz for USA and Canada 110/120/220/240V, 50/60 Hz internally switchable for the other countries including Europe
POWER CONSUMPTION	9W
DIMENSIONS	440 (W) × 78 (H) × 226 (D) mm (17.3 × 3.1 × 8.9) inches
WEIGHT	3.3 kg (7.3 lbs)

* For improvement purposes, design and specifications are subject to change without notice.

II. CONTROLS

1. MODEL DT-100

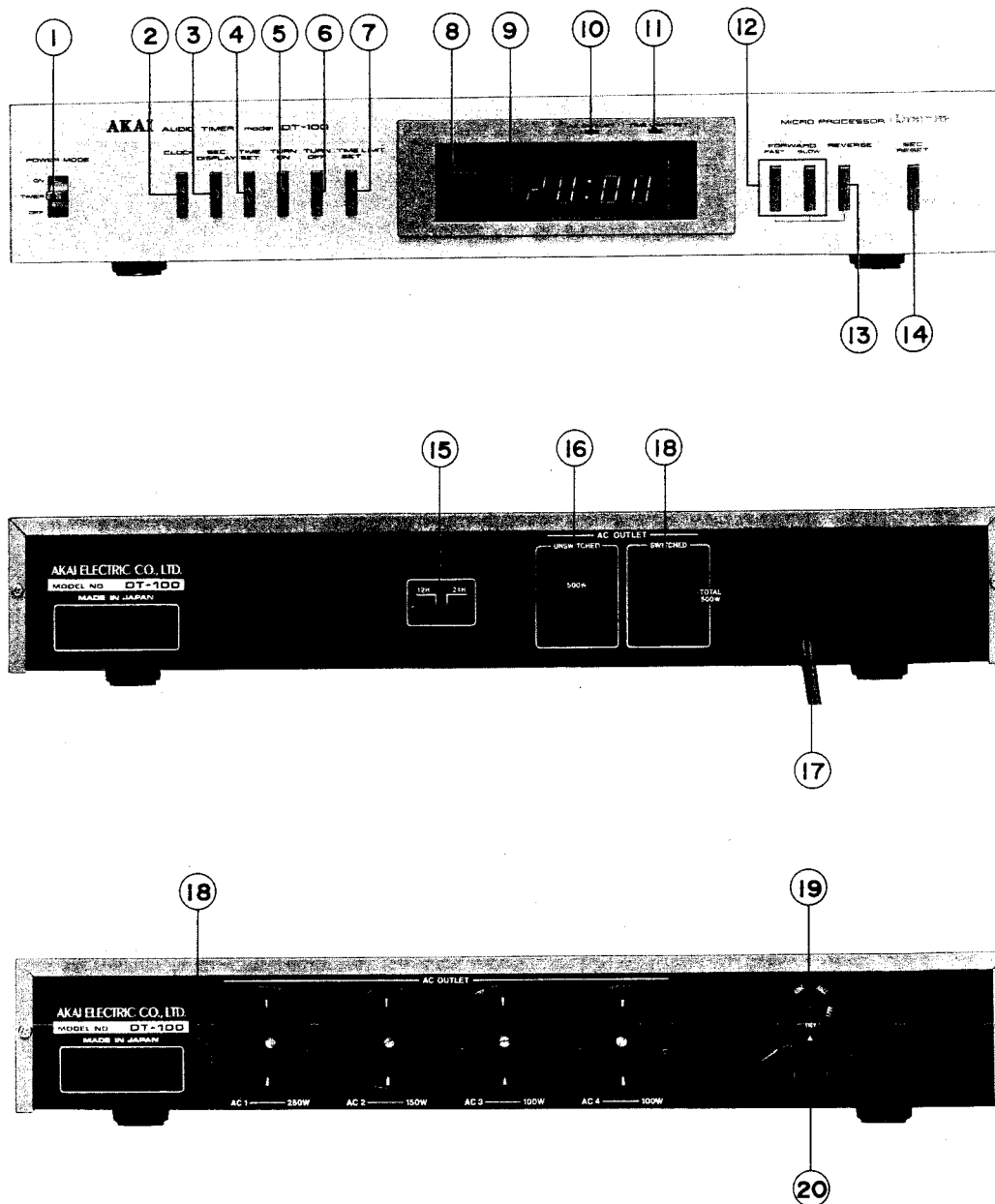
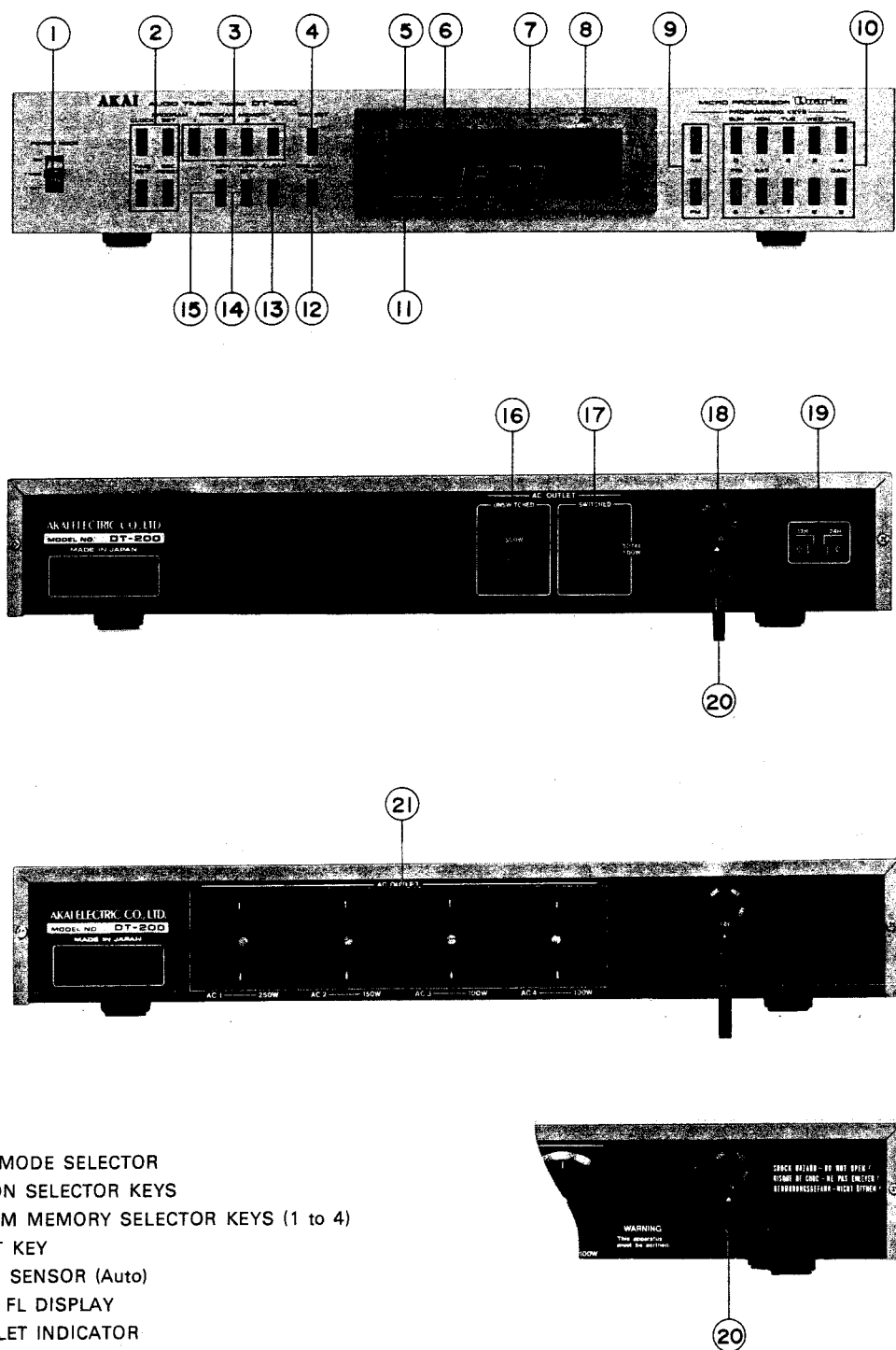

Fig. 1 Controls

- | | |
|------------------------------|--|
| 1. POWER MODE SELECTOR | 12. FAST AND SLOW BUTTONS |
| 2. CLOCK BUTTON | 13. REVERSE BUTTON |
| 3. SEC. DISPLAY BUTTON | 14. SEC. RESET BUTTON |
| 4. TIME SET BUTTON | 15. 12 HOUR/24 HOUR DISPLAY SELECTOR
(Not on some models) |
| 5. TURN ON BUTTON | 16. AC OUTLETS (Unswitched) (Not on some models) |
| 6. TURN OFF BUTTON | 17. AC POWER CORD |
| 7. TIME LIMIT SET BUTTON | 18. AC OUTLETS (Switched) |
| 8. DIMMER SENSOR (Auto) | 19. VOLTAGE SELECTOR (Not on some models) |
| 9. TIME DISPLAY | 20. AC INLET |
| 10. AC OUTLET INDICATOR | |
| 11. TIME LIMIT SET INDICATOR | |

2. MODEL DT-200



1. POWER MODE SELECTOR
2. FUNCTION SELECTOR KEYS
3. PROGRAM MEMORY SELECTOR KEYS (1 to 4)
4. DAY SET KEY
5. DIMMER SENSOR (Auto)
6. DIGITAL FL DISPLAY
7. AC OUTLET INDICATOR
8. ONE HOUR PLAY INDICATOR
9. AM/PM PROGRAMING KEYS (Not on some models)
10. PROGRAMING KEYS
11. AM/PM INDICATORS (Not on some models)
12. ONE HOUR PLAY KEY
13. CLEAR KEY
14. TURN OFF KEY
15. TURN ON KEY
16. UNSWITCHED AC OUTLET (Not on some models)
17. SWITCHED AC OUTLETS
18. VOLTAGE SELECTOR (Not on some models)
19. 12 HOUR/24 HOUR DISPLAY SELECTOR
(Not on some models)
20. AC POWER CORD (Some models are equipped with an AC Inlet instead of an AC cord. Connect with an appropriate power cord.)
21. AC OUTLETS (Switched)

Fig. 2 Controls

III. PRINCIPAL PARTS LOCATION

1. MODEL DT-100

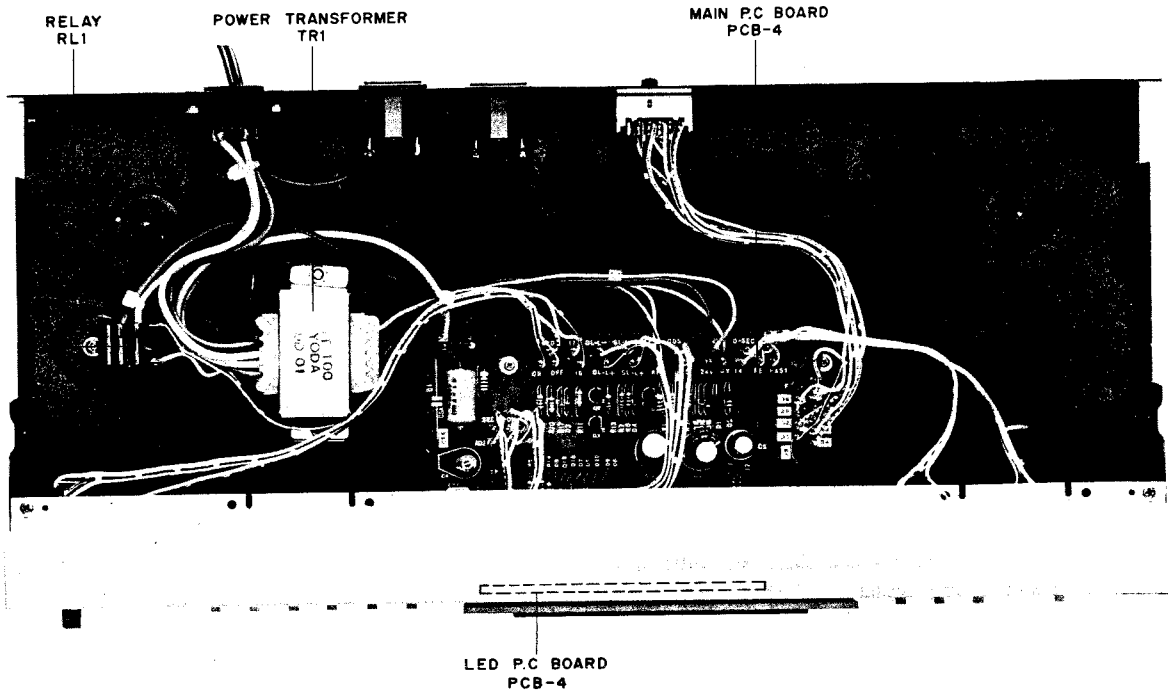

Fig. 3 Top VIEW

2. MODEL DT-200

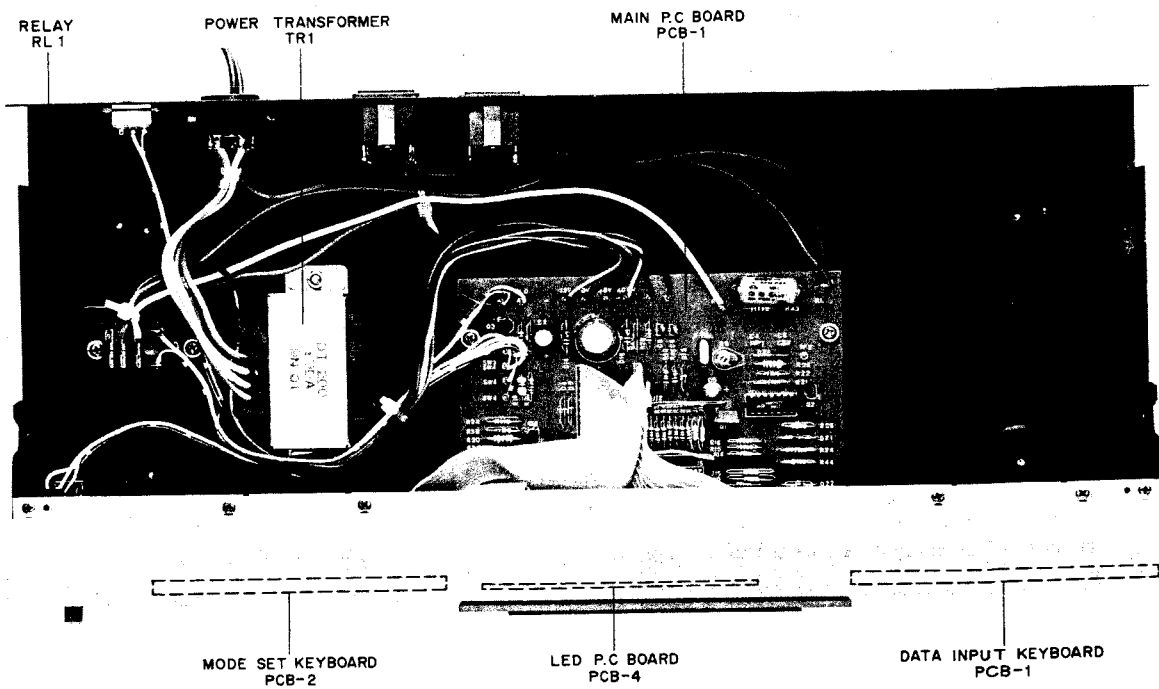

Fig. 4 Top View

IV. EXPLANATION HOW TO USE

MODEL DT-100

1. SET THE TIMER TO THE ACTUAL TIME

- 1) Plug in the Power Cord to a household AC Outlet.
- 2) On the Time Display "AM 12:00" or "0:00" will flash on and off depending on the setting of 12 Hour/24 Hour Display selector.
- 3) Press the Time Set button, then keep pressing the Fast or Slow button until the actual time appears on the Time Display.
- 4) Press the Sec Display button, then the Sec Reset button to set the seconds to zero (to synchronize the Timer with the actual time).
- 5) Press the Clock button so that even if the Fast or Slow button is pressed accidentally the actual time that was set will not change.

2. SET THE TIMER

- 1) Connect the external components' power cords to the Timer's AC Outlets (switched).
- 2) Plug in the Power Cord to a household AC Outlet and set the Timer to the actual time. (See "SET THE TIMER TO THE ACTUAL TIME".)
- 3) Set the Power Mode Switch to ON and adjust the external components (following the manufacturers' instructions).
- 4) Press the Turn ON button, the Fast or Slow button and set the time for the external components to turn on.
- 5) Press the Turn Off button, the Fast or Slow button and set the time for the external components to turn off.
- 6) Press the Clock button.
- 7) Set the Power Mode selector to Timer.
 - When starting the timer from OFF, please put the Power Mode Switch to OFF and then TIMER.

3. SET THE TIME LIMIT

- 1) Connect the external components to the Timer's AC Outlets.
- 2) Plug in the Power Cord to a household AC Outlet and set the Timer to the actual time.
- 3) Set the Power Mode Switch to ON and adjust the external components (follow the manufacturers' instructions).
- 4) Press the Time Limit Set Button, the Fast or Slow Button and set the length of time the external components are to be on (in other words after how long the external components are to be turned off).
- 5) Press the Clock Time Button.
- 6) Set the Power Mode Switch to TIMER.
 - To cancel the Timer Limit Set, set the time length to "0:00".
 - Time Limit will take priority over the time set to turn off.

If you have made a mistake in any of the above ("SET THE TIMER TO THE ACTUAL TIME", "SET THE TIMER", "SET THE TIME LIMIT") repeat the whole procedure.

4. BLACKING

After a blackout, the Time Display will revert to flashing "AM 12:00" or "0:00". Therefore reset the Timer after a blackout.

To reconfirm the times set press the following buttons:
Time for the external components

to turn on Turn On Button
Time for the external components

to turn off Turn Off Button
Time left in the Time Limit Time Limit Set Button
Seconds of the actual time Sec Display Button

MODEL DT-200

1. SETTING THE TIMER TO THE ACTUAL TIME

Taking setting to 7:00 a.m. Sunday as an example:

- 1) Connect the timer's power cord to the mains power supply.
The 'E' error mark on the FL Display should flash.
• The 'E' will also flash repeatedly after power failures.
- 2) Depress the TIME SET key. Items still to be set will begin to flash on the FL Display. Depress the PROGRAMING keys in the following order:

1. 24 Hour Indication

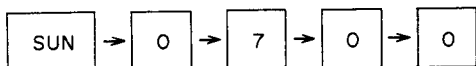

If it is for 7 o'clock in the evening, set as 19:00.

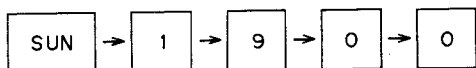

2. 12 Hour Indication

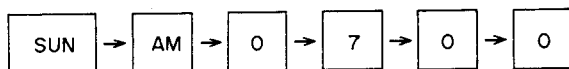

- 3) Keeping exactly the same, wait until the 7 a.m. announcement of the time, standard time, etc. When it is 7 a.m. depress the SEC RESET key.

NOTE: The minute indication will not change when the SEC RESET key is depressed during the period 0 to 29 secs. One minute will be added during the period 30 to 59 secs.

- 4) Depress the CLOCK key.
• The flashing concentric circles will disappear.

Your timer is now set but if you made a mistake in setting the timer, repeat from Step 2.

2. ONE HOUR PLAY

Overrides all other operations. Please set the timer to CLOCK always.

- 1) The POWER MODE selector must be set to TIMER.
- 2) Depress the ONE HOUR PLAY key. Cancel by depressing the CLOCK key.

3. PROGRAMING

This timer can be programed to turn the power on four times and the power off four times. There follows four examples of programs which can be retained in the timer's memory.

PROGRAM 1

Turn on at 7:00 a.m. and off at 8:00 a.m. daily.

PROGRAM 2

Turn on at 9:00 a.m. and turn off at 9:45 a.m. on Mondays, Wednesdays and Fridays.

PROGRAM 3

Turn on at 7:30 p.m. (19:30) and turn off at 8:30 p.m. (20:30) on Tuesdays, Thursdays and Saturdays.

PROGRAM 4

Turn on at 9:00 p.m. (21:00) on Sundays and turn off at 11:30 a.m. the following morning.

- Confirm program setting by depressing the PROGRAM SET key and the respective PROGRAM MEMORY selector key. The turn on time will be shown. Depress the TURN OFF key to show the turn off time.

4. PROGRAM 1

- 1) Depress the PROGRAM SET key.
- 2) Depress the PROGRAM MEMORY selector key 1.
- 3) Depress the TURN ON key.
- 4) Use the PROGRAMING key to set the day when the power is to turn on.



- 5) Set the timer to the time when the timer is to turn on.
• With the 12 hour indication depress the AM key first.

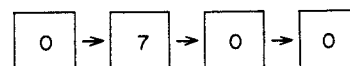

- 6) Depress the TURN OFF key.
- 7) Depress the PROGRAMING keys in the following order:
• With the 12 hour indication, depress the AM key first.

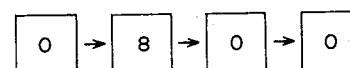

5. PROGRAM 2

- 1) Depress the PROGRAM SET key.
- 2) Depress PROGRAM MEMORY selector key 2.
- 3) Depress the TURN ON key.
- 4) Use the PROGRAMING keys to set the day when the power is to turn on.

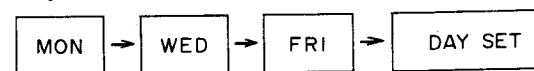

- Depress the respective day key once and it appears, twice and it is cancelled.

- 5) Set the timer to the time when it is to turn on.
• With the 12 hour indication, depress the AM key first.

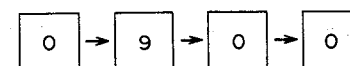

- 6) Depress the TURN OFF key.
• With the 12 hour indication, depress the AM key first.

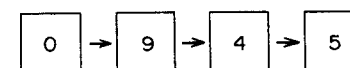

6. PROGRAM 3

- 1) Depress the PROGRAM SET key.
- 2) Depress PROGRAM MEMORY selector key 3.
- 3) Depress the TURN ON key.
- 4) Use the PROGRAMING keys to set the days when the power is to turn on.
 - Depress the respective day key once and it appears, twice and it is cancelled.

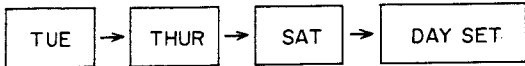

- 5) Set the timer to the time when it is to turn on.
 - With the 12 hour indication, depress the PM key first.

24 Hour Indication



12 Hour Indication



- 6) Depress the TURN OFF key.
- 7) Depress the PROGRAMING keys in the following order.
 - With the 12 hour indication, depress the PM key first.

24 Hour Indication



12 Hour Indication



7. PROGRAM 4

- 1) Depress the PROGRAM SET key.
- 2) Depress the PROGRAM MEMORY selector key 4.
- 3) Depress the TURN ON key.
- 4) Use the PROGRAMING keys to set the day when the power is to turn on.

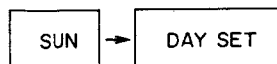

- Depress the respective day key and it appears, twice and it is cancelled.

- 5) Set the timer to the time when it is to turn on.
 - With the 12 hour indication, depress the PM key first.

24 Hour Indication

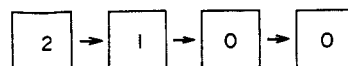

12 Hour Indication

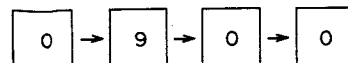

- 6) Depress the TURN OFF key.
- 7) Depress the PROGRAMING keys in the following order:
 - With the 12 hour indication, depress the AM key first.

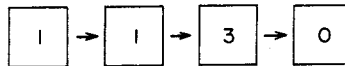

If you have made a mistake in setting any program:

- 1) Depress the PROGRAM SET key.
- 2) Depress the PROGRAM MEMORY selector for the mistaken program.
- 3) Depress the CLEAR key.
- 4) Re-program.

V. ADJUSTMENT

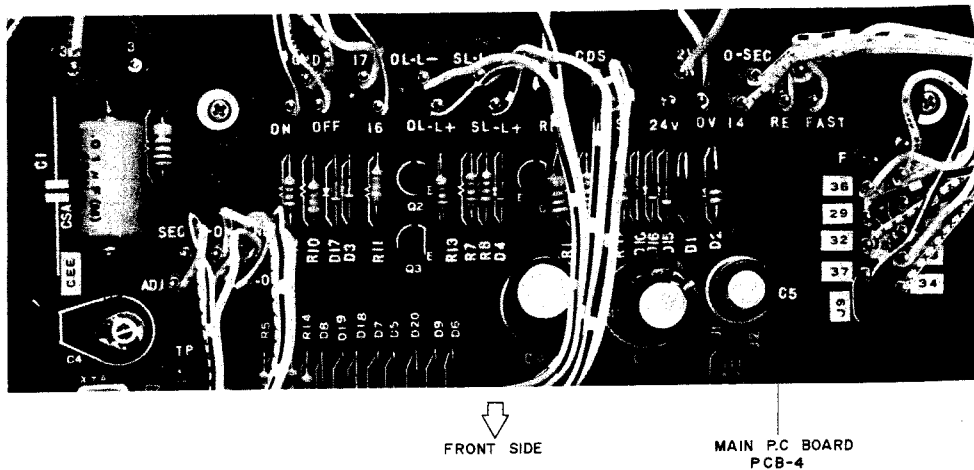

MAIN P.C BOARD PCB-4
Fig. 5 Main P.C Board PCB-4 (DT-100)

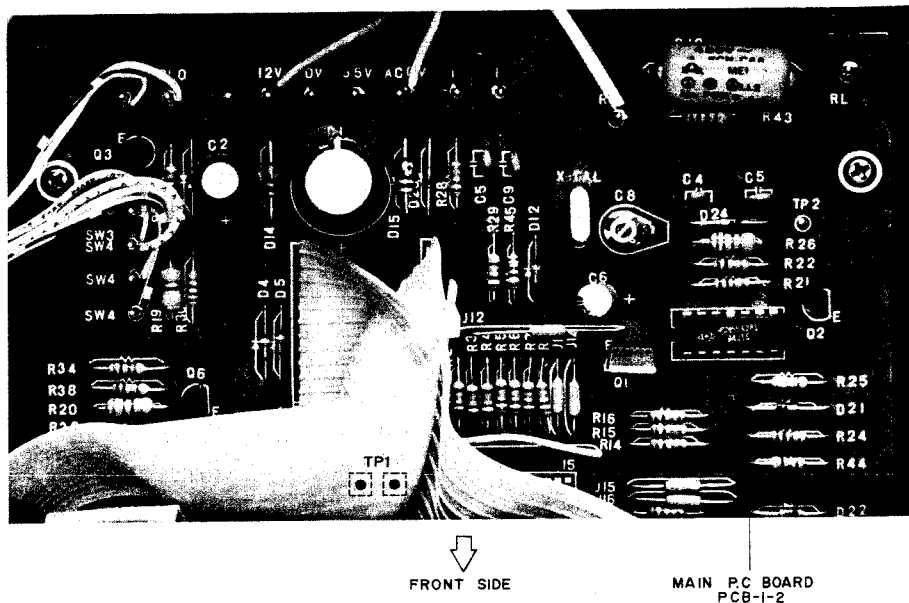

MAIN P.C BOARD PCB-1-2
Fig. 6 Main P.C Board PCB-1-2 (DT-200)

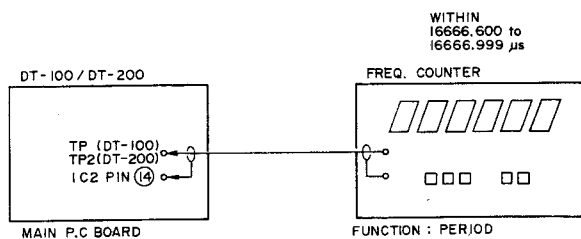

Fig. 7 Instrument Connections

REFERENCE PERIOD SIGNAL MICROADJUSTMENT (Refer to Fig. 5 to 7.) Connect the frequency counter to TP (DT-100), TP2 (DT-200) and pin 14 of IC2, set function to "period".

Adjust the trimmer capacitor C4 so that frequency counter reads within 16666.600 to 16666.699 μ s.

Quick confirmation of the timer setting is possible by short-circuiting TP1s (DT-200 only), as this will cause the set's time count to become 60 times as large, changing the digit that would otherwise be for "minutes" into "seconds", and that for "hours" into "minutes".

NOTE: Disconnect the power cord before short (or release) TP1s.

VI. COMPOSITION OF VARIOUS P.C BOARDS

1. MAIN P.C BOARD PCB-4 (DT-100)

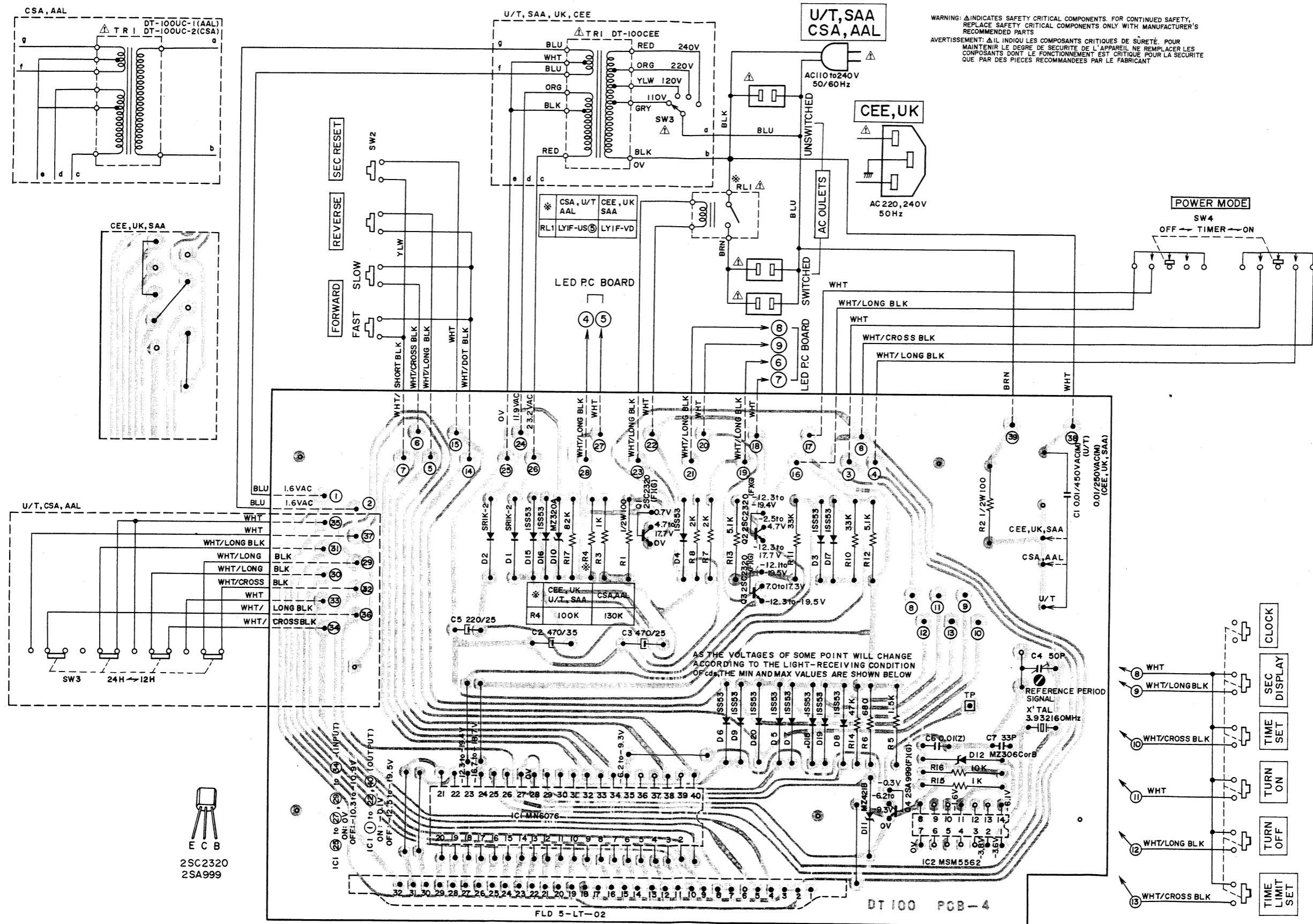

2. MAIN P.C BOARD PCB-1-2 (DT-200)

DATA INPUT KEY BOARD PCB-3

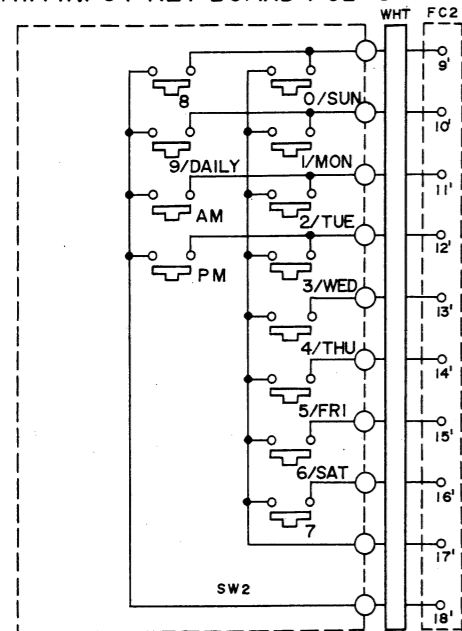

MODE SET KEY BOARD PCB-2

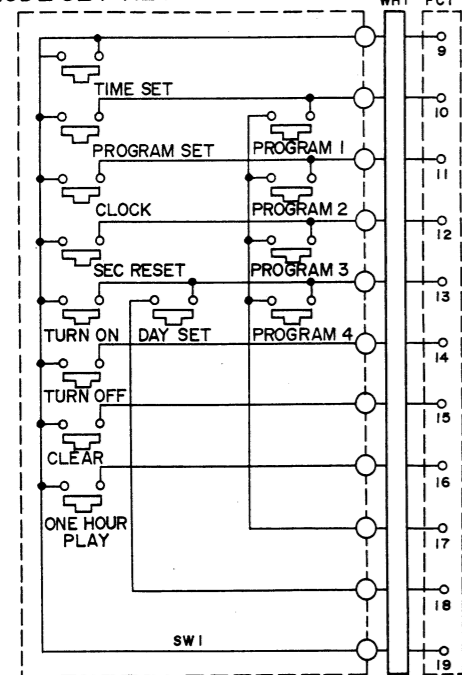

MAIN P.C BOARD PCB-1-2

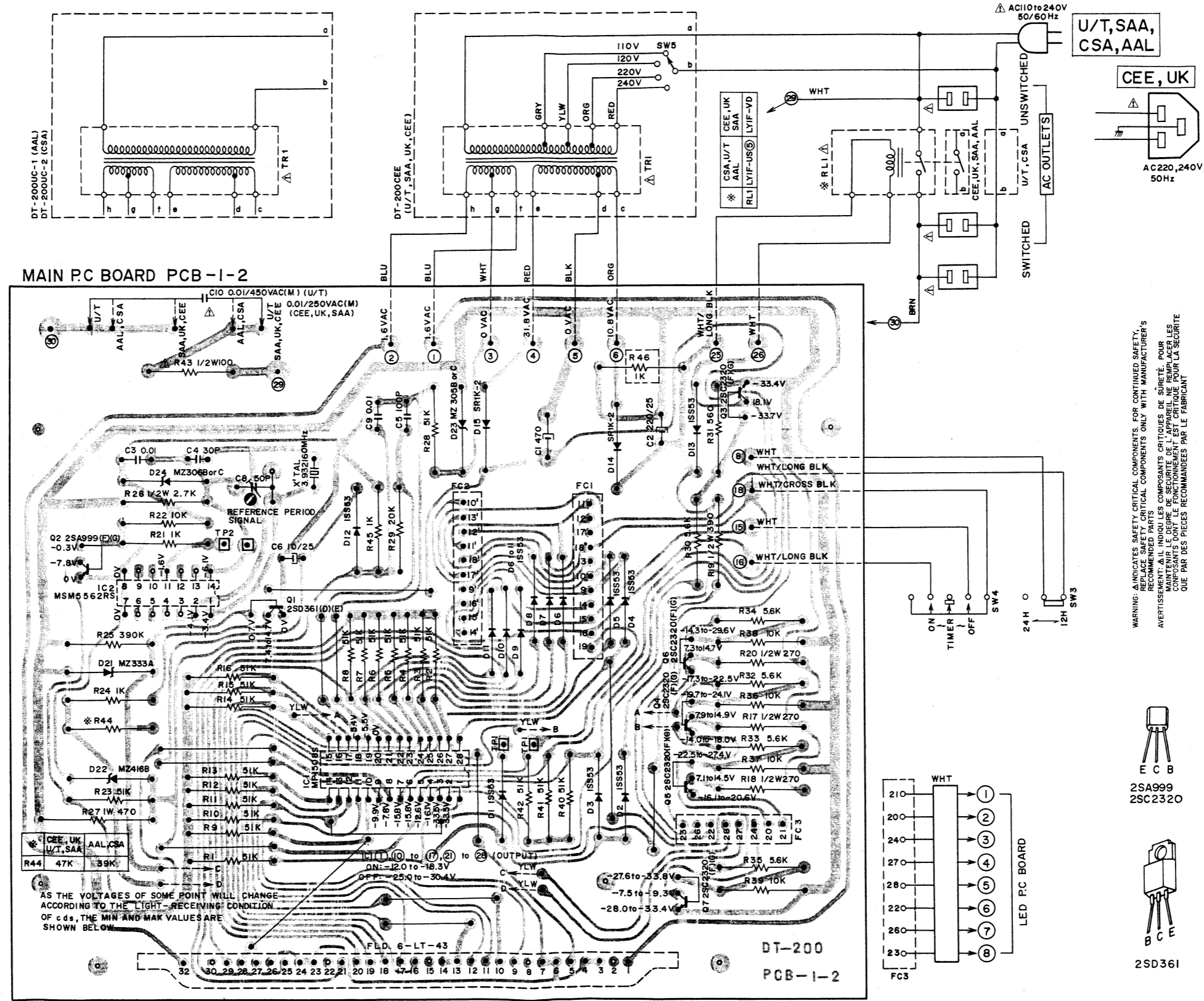

3. LED P.C BOARD PCB-4 (DT-100/DT-200)

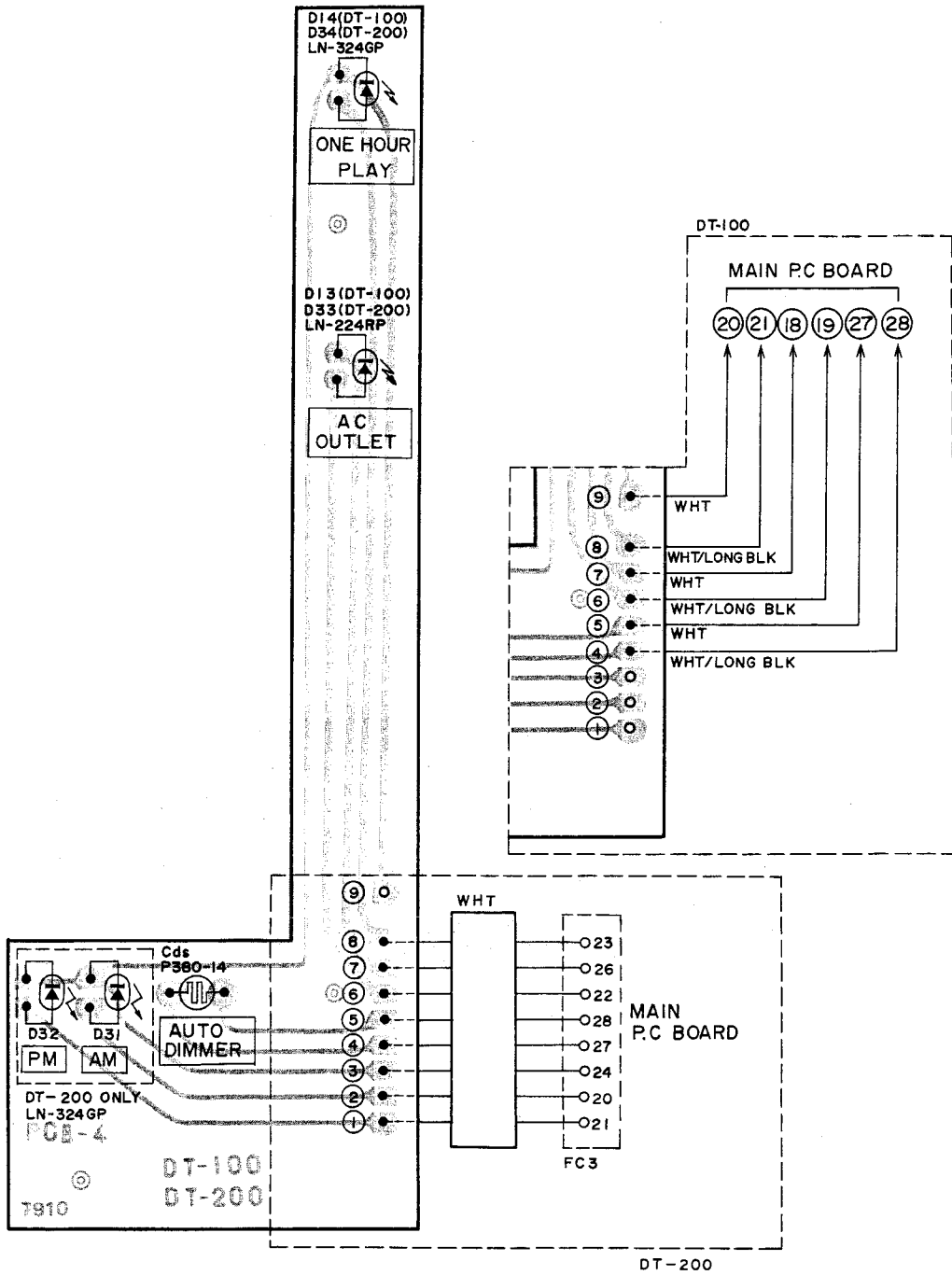

MEMO

MEMO

MEMO

SECTION 2

PARTS LIST

TABLE OF CONTENTS

I. MODEL DT-100

- 1. MAIN P.C BOARD (PCB-4) BLOCK..... 22**
- 2. LED P.C BOARD (PCB-4) BLOCK 22**
- 3. ASSEMBLY BLOCK 22**
- 4. FINAL ASSEMBLY BLOCK 23**

II. MODEL DT-200

- 1. MAIN P.C BOARD (PCB-1-2) BLOCK..... 24**
- 2. LED P.C BOARD (PCB-4) BLOCK 24**
- 3. ASSEMBLY BLOCK 24**
- 4. FINAL ASSEMBLY BLOCK 25**

INDEX 26

Resistor and Capacitor which is not listed in this parts list, please refer to COMMON LIST FOR SERVICE PARTS.

HOW TO USE THIS PARTS LIST

1. This parts list is compiled by various individual blocks based on assembly process.
2. When ordering parts, please describe parts number, serial number, and model number in detail.
3. How to read list.

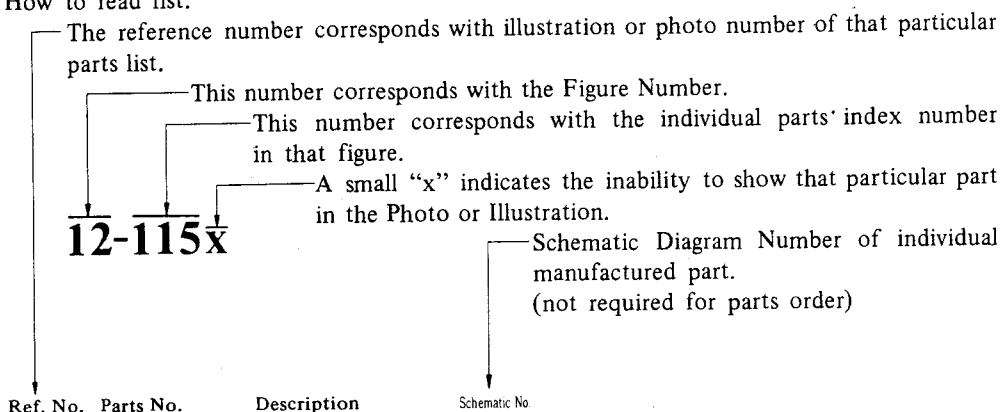

FLYWHEEL BLOCK #13			
Ref. No.	Parts No.	Description	Schematic No.
12-115x	800425	Flywheel Block Assy. Comp.	RDG #13
12-116	244506	Flywheel Only	RD: 233
12-117x	244754	Felt, Flywheel	RD: 275
12-118	251324	Main Metal Case	RD: 236
12-119	253080	Main Metal	RD: 237

4. The symbol numbers shown on the P.C. Board list can be matched with the Composite Views of components of the Schematic Diagram or Service Manual.
5. The indications of Resistors and Capacitors in the photos of P.C. Board are being eliminated.
6. The shape of the parts and parts name, etc. can be confirmed by comparing them with the parts shown on the Electrical Parts Table of P.C. Board.
7. Both the kind of part and installation position can be determined by the Parts Number. To determine where a parts number is listed, utilize Parts Index at end of Parts List.
It is necessary first of all to find the Parts Number. This can be accomplished by using the Reference Number listed at right of parts number in the Parts Index. (meaning of ref. no. outlined in Item 3 above).
8. Utilize separate "Price List for Parts" to determine unit price. The most simple method of finding parts Price is to utilize the reference number.

CAUTION:

1. When placing an order for parts, be sure to list the parts no. model no., and description. There are instances in which if any of this information is omitted, parts cannot be shipped or the wrong parts will be delivered.
2. Please be careful not to make a mistake in the parts no. If the parts no. is in error, a part different from the one ordered may be delivered.
3. Because parts number and parts unit supply in the Preliminary Service Manual (Basic Parts List) may be partially changed, please use this parts list for all future reference.

WARNING: Δ INDICATES SAFETY CRITICAL COMPONENTS. FOR CONTINUED SAFETY, REPLACE SAFETY CRITICAL COMPONENTS ONLY WITH MANUFACTURER'S RECOMEMNDED PARTS.

AVERTISSEMENT: Δ IL INDIQU LES COMPOSANTS CRITIQUES DE SURETE. POUR MAINTENIR LE DEGRE DE SECURITE DE L'APPAREIL NE REMPLACER LES COMPOSANTS DONT LE FONCTIONNEMENT EST CRITIQUE POUR LA SECURITE QUE PAR DES PIECES RECOMMANDEES PAR LE FABRICANT.

AC INLET SYSTEM

This model is equipped with an AC INLET SYSTEM. Please refer to the AC INLET SYSTEM CHART below for the specific type. By the AC INLET SYSTEM, AC (mains) cord can be connected to and disconnected from the model because the model is provided with socket exclusively for AC (mains) cord on its main body.

Please note, however, that certain models are not equipped with this system and has a built-in AC (mains) cord as before.

AC INLET SYSTEM CHART

CLASS I

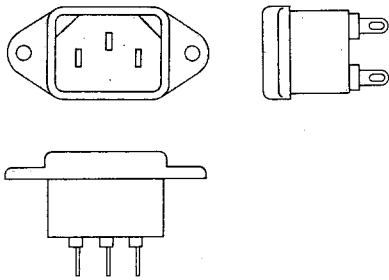

Picture 1
AC INLET
to be
installed
on machines

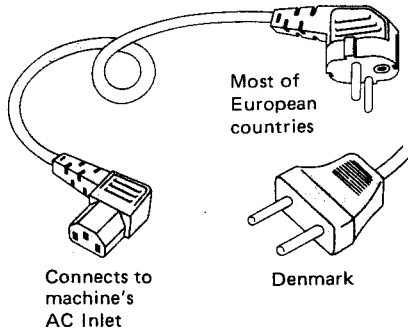

Most of
European
countries

Denmark

Connects to
machine's
AC Inlet



U.K.

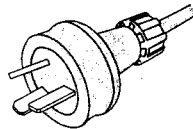

Australia
differs according
to wall socket

CLASS II

☐ This mark indicating double insulation will be attached to machine's rear panel

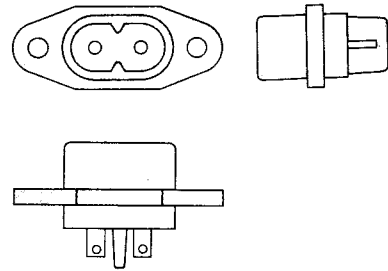

Connects to
machine's
AC Inlet

Most of the
European
countries

Picture 2
AC (mains)
cord

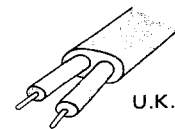

U.K.



Australia
differs according
to wall socket

Parts List for AC (mains) Cord Set

Standard		Description	Type of AC Inlet	Parts No.
Class I	CEE	Cord Set CEE (3 cores)	3P	EW302993
	BEAB	Cord Set BEAB (3 cores)	3P	EW302994
	SAA	Cord Set SAA (3 cores)	3P	EW302995
	U/T	Cord Set U/T (3 cores)	3P	EW302645
Class II	CEE	Cord Set CEE (2 cores)	2P	EW638144
	BEAB	Cord Set BEAB (2 cores)	2P	EW302995
	SAA	Cord Set SAA (2 cores)	2P	EW302991
	U/T	Cord Set U/T (2 cores)	2P	EW302899

I. MODEL DT-100

1. MAIN P.C BOARD (PCB-4) BLOCK

Ref. No.	Parts No.	Description	Schematic No.
1-IC1	EI700654	IC MN6076	MN6076
1-IC2	EI700655	IC MSM5562	MSM5562
1-Q1T03	ET328569	TR 2SC2320 (F)	45-1-409
1-Q4	ET700657	TR 2SA999 (F), (G)	2SA999F, G
1-D1,2	ED700722	D Silicon H SR1K-2	SR1K-2
1-D3T09	ED302379	D Silicon H 1SS53	45-3-43
1-D10	ED700658	D Zener H MZ320 A	MZ320A
1-D11	ED700659	D Zener H MZ412 B	HZ412B
1-D12	ED700723	D Zener H MZ306 B	MZ306B
1-X'TAL	EI700662	OSC X'tal 3.932160MC	3.932160MHZ
1-FLD	EI700656	IND FLD 5-LT-02 Character	5-LT-02
1-C1	EC306477	△ C Oil H ECN-C 103M 450AC (U/T)	24-8-6
1-C1	EC325671	△ C MP V 103M 250AC (CEE)	24-9-134
1-C4	EC315346	C S-Fix H ECV-1ZW50X32E	5.0-55 24-2-48

2. LED P.C BOARD (PCB-4) BLOCK

Ref. No.	Parts No.	Description	Schematic No.
2-D13	ED700664	LED LN-224RP Red (AC OUTLET)	LN-224RP
2-D14	ED700665	LED LN-324GP Grn (TIME LIMIT SET)	LN-324GP
2-CDS	ET700663	CDS P380-14 (AUTO DIMMER)	P380-14

3. ASSEMBLY BLOCK

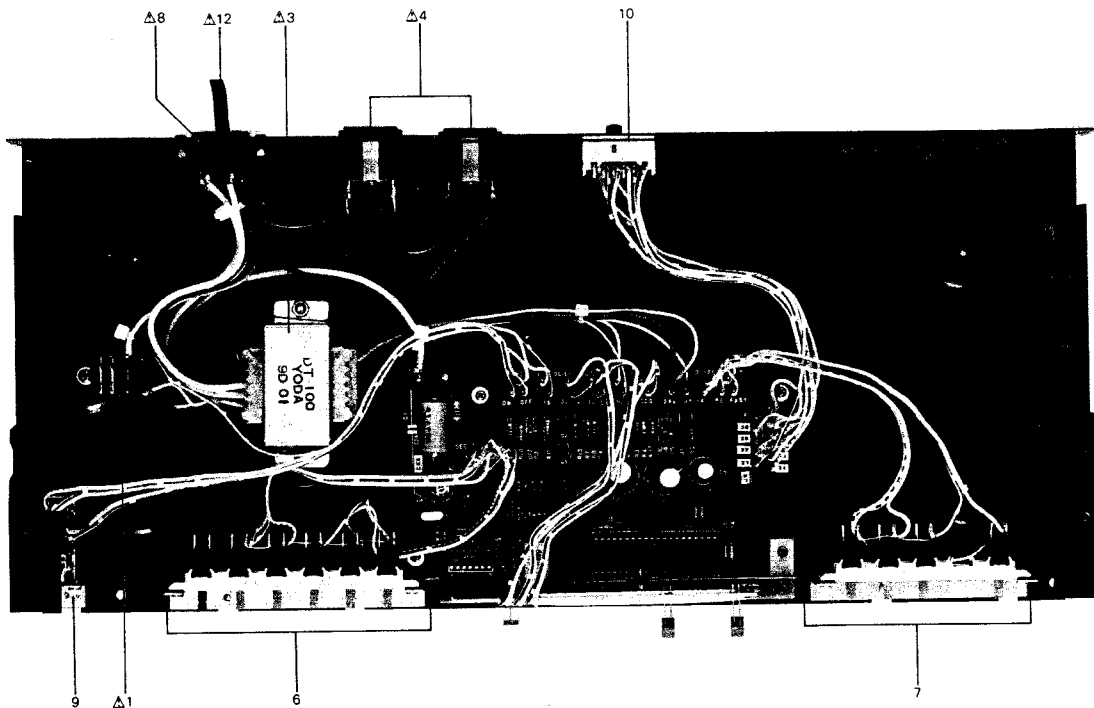

ASSEMBLY BLOCK

Ref. No.	Parts No.	Description	Schematic No.	Ref. No.	Parts No.	Description	Schematic No.
3-1	EP700724	△ Relay Power LY1F-US5 (U/T)	LY1F-US5	3-9	ES700676	SW Lever SJE-23P	SJE-23P
3-2x	EP700725	△ Relay Power LY2F-VD (CEE)	LY2F-VD	3-10	ES700677	SW Slide SW42-7P (U/T)	SQ-42-7P
3-3	BT700666	△ Trans Power DT-100CEE	DT-100CEE	3-11x	EZ631945	Strain Relief SR-4N-4 (U/T)	2-7-49
3-4	EJ700667	△ Socket Outlet S2-723B-50 (U/T)	S2-723B-50	3-12	EW374894	△ AC Cord 2 Cores VM-0129A J (U/T)	26-3-19
3-5x	EJ700668	△ Socket Outlet Type-418038 (CEE)	TYPE-418038	3-13x	EJ296853	△ Socket Inlet CM-3 UCEB 3P (CEE)	31-1-199
3-6	ES700674	SW Push SUH-62V 6-THROW	SUH-62V	3-14x	EW496855	△ AC Cord 3 Cores VM-0099 E (CEE)	26-3-27
3-7	ES700675	SW Push SUH-42V 4-THROW	SUH-42V				
3-8	ES700720	△ SW Selector ESE-372	ESE-372				

When ordering parts, please quote Parts Number, Description and Model Number.

4. FINAL ASSEMBLY BLOCK

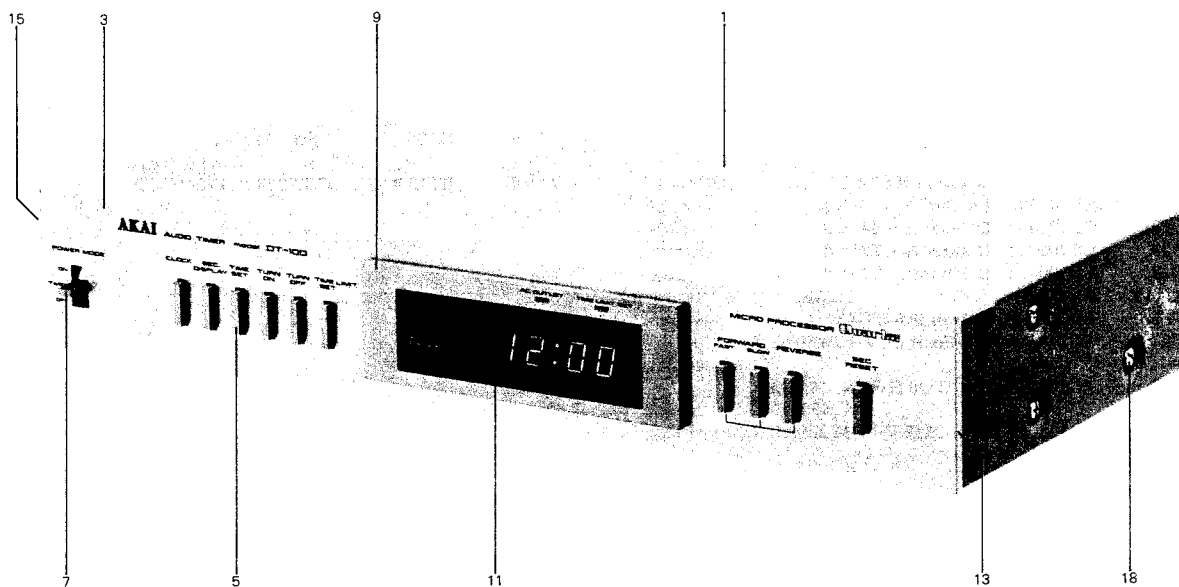

FINAL ASSEMBLY BLOCK

Ref. No.	Parts No.	Description	Schematic No.
4-1	SP700669	Case	0:SB11-S
4-2x	SP700670	Case (BL)	0:SB11-B
4-3	SP700671	Panel Front	0:SB03-S
4-4x	SP700673	Panel Front (BL)	0:SB03-B
4-5	SK700678	Key Top 1	0:SB09-S
4-6x	SK700679	Key Top 1 (BL)	0:SB09-B
4-7	SK700680	Key Top 2	0:SB10-S
4-8x	SK700681	Key Top 2 (BL)	0:SB10-B
4-9	SP700682	Panel Sub	0:SB04100S
4-10x	SP700684	Panel Sub (BL)	0:SB04100B
4-11	SZ700685	Panel Smoke	0:SB05-CEE
4-12x	SZ323193	FLD Plate	ATV-4037
4-13	TA322176	Pad (L-1)	ATK-2015
4-14x	TA322178	Pad (L-1-BL)	ATK-2015
4-15	TA322179	Pad (R-1)	ATK-2015
4-16x	TA322180	Pad (R-1-BL)	ATK-2015
4-17x	SA311742	Round Foot	PC-2032
4-18	ZS321782	BID 40 × 08 STL N 13	
4-19x	ZS537074	BID 40 × 06 STL BNI	
4-20x	ZS609478	PAN 26 × 06 STL BNI	
4-21x	ZS417407	PAN 30 × 10 STL BNI	
4-22x	ZS609208	T2 PAN 30 × 08 STL BNI	

When ordering parts, please quote Parts Number, Description and Model Number.

II. MODEL DT-200

1. MAIN P.C BOARD (PCB-1-2) BLOCK

Ref. No.	Parts No.	Description	Schematic No.
1-IC1	EI700693	IC MP1508S	MP-1508S
1-IC2	EI700655	IC MSM5562	MSM5562
1-Q1	ET537300	TR 2SD361 (D) (E)	45-1-143
1-Q2	ET700657	TR 2SA999 (F) (G)	2SA999F.G
1-Q3T07	ET328569	TR 2SC2320 (F)	45-1-409
1-D1T013	ED302379	D Silicon H 1SS53	45-3-43
1-D14,15	ED700722	D Silicon H SR1K-2	SR1K-2
1-D21	ED700695	D Zener H MZ333 A	MZ333A
1-D22	ED700696	D Zener H MZ416 B	MZ416B
1-D23	ED700721	D Zener H MZ305 B	MZ305B
1-D24	ED700723	D Zener H MZ306 B	MZ306B
1-X'TAL	EI700662	OSC X'tal 3.932160MC	3.932160MHZ
1-FLD	EM700698	IND FLD 6-LT-43	6-LT-43
1-C8	EC315346	C S-Fix H ECV-1ZW50X32E	5.0-55 24-2-48
1-C10	EC306477	△ C Oil H ECN-C 103M 450AC (U/T)	24-8-6
1-C10	EC325671	△ C MP V 103M 250AC (CEE)	24-9-134

2. LED P.C BOARD (PCB-4) BLOCK

Ref. No.	Parts No.	Description	Schematic No.
2-D31	ED700665	LED LN-324GP GRN (AM)	LN-324GP
2-D32	ED700665	LED LN-324GP GRN (PM)	LN-324GP
2-D33	ED700664	LED LN-224RR RED (AC OUTLET)	LN-224RP
2-D34	ED700665	LED LN-324GP GRN (ONE HOUR PLAY)	LN-324GP
2-CDS	ET700663	CDS P380-14 (DIMMER)	P380-14

3. ASSEMBLY BLOCK

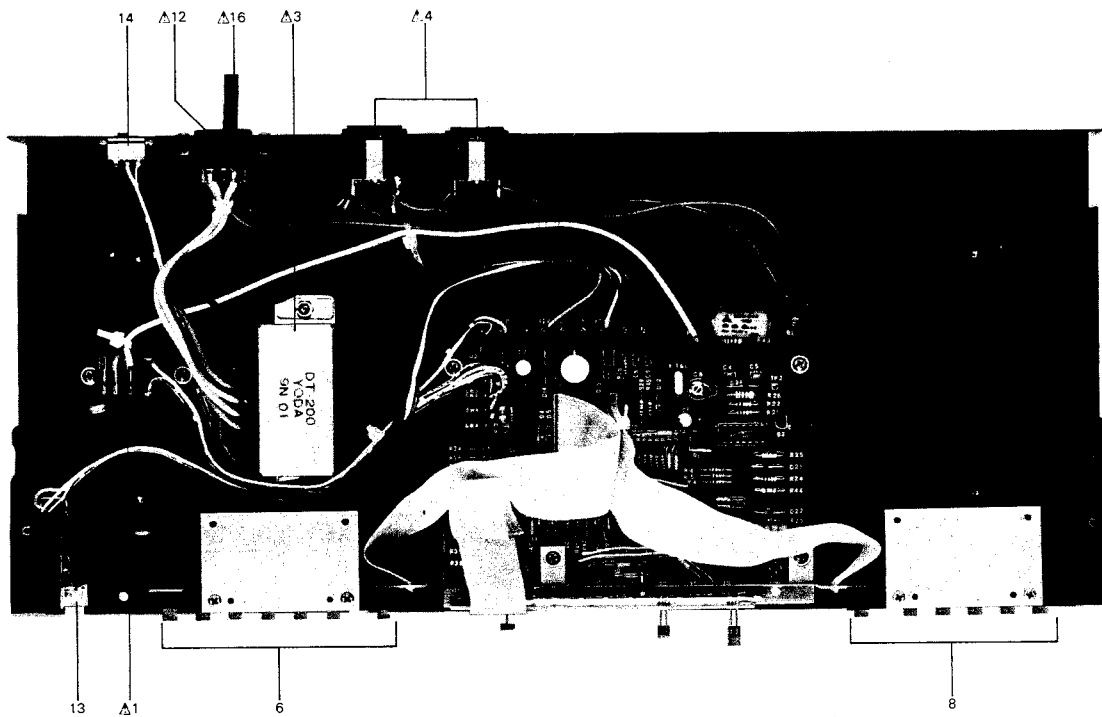

ASSEMBLY BLOCK

Ref. No.	Parts No.	Description	Schematic No.	Ref. No.	Parts No.	Description	Schematic No.
3-1	EP700724	△ Relay Power LY1F-US5 (U/T)	LY1F-US5	3-11x	ES700711	SW Operation (BL) 01SB07-B (CEE)	01SB07-B
3-2x	EP700725	△ Relay Power LY2F-VD (CEE)	LY2F-VD	3-12	ES700720	△ SW Selector ESE-372	ESE-372
3-3	BT700697	△ Trans Power DT-200CEE	DT-200CEE	3-13	ES700676	SW Lever SJE-23P	SJE-23P
3-4	EJ700667	△ Socket Outlet S2-723B-50 (U/T)	S2-723B-50	3-14	ES700707	SW Slide SA-1 (U/T)	SA-1
3-5x	EJ700668	△ Socket Outlet Type-418038 (CEE)	TYPE-418038	3-15x	EZ700744	Strain Relief F4 (U/T)	
3-6	ES700708	SW Operation 01SB06-S	01SB06-S	3-16	EW374894	△ AC Cord 2 Cores VM-0129A J (U/T)	26-3-19
3-7x	ES700709	SW Operation (BL) 01SB06-B	01SB06-B	3-17x	EJ296853	△ Socket Inlet CM-3 UCEB 3P (CEE)	31-1-199
3-8	ES700712	SW Operation 01SB08-S (U/T)	01SB08-S	3-18x	EW496855	△ AC Cord 3 Cores VM-0099 E (CEE)	26-3-27
3-9x	ES700713	SW Operation (BL) 01SB08-B (U/T)	01SB08B				
3-10x	ES700710	SW Operation 01SB07-S (CEE)	01SB07-S				

When ordering parts, please quote Parts Number, Description and Model Number.

4. FINAL ASSEMBLY BLOCK

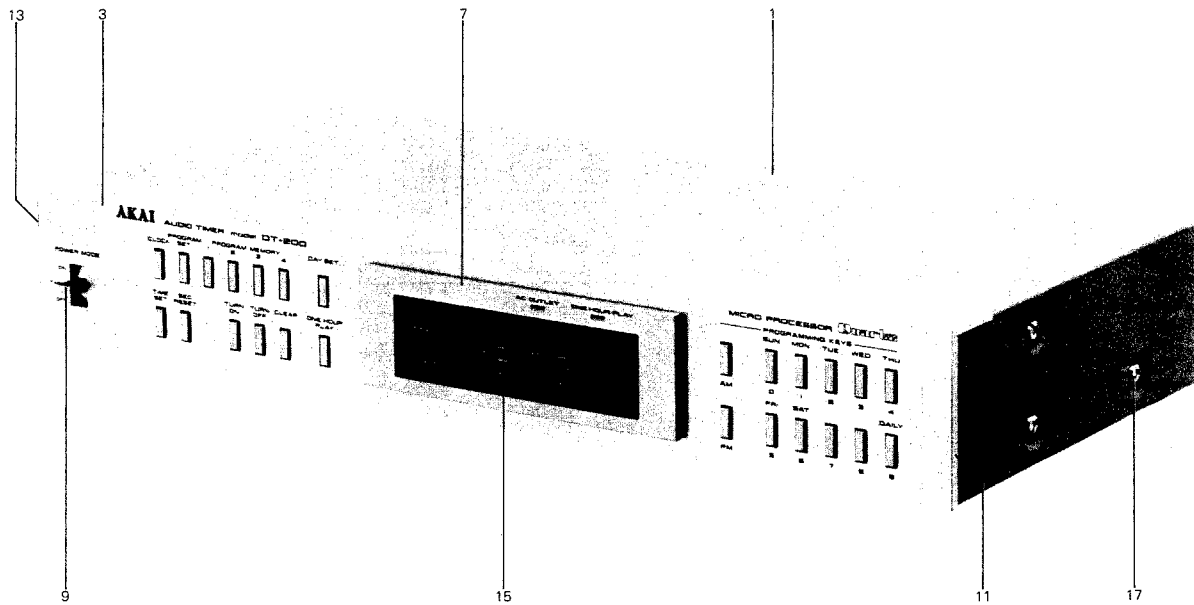

FINAL ASSEMBLY BLOCK

Ref. No.	Parts No.	Description	Schematic No.
4-1	SP700669	Case	01SB11-S
4-2x	SP700670	Case (BL)	01SB11-B
4-3	SP700701	Panel Front (U/T)	01SB02-S
4-4x	SP700702	Panel Front (BL) (U/T)	01SB02-B
4-5x	SP700699	Panel Front (CEE)	01SB01-S
4-6x	SP700700	Panel Front (BL) (CEE)	01SB01-B
4-7	SP700703	Panel Sub	01SB04200S
4-8x	SP700704	Panel Sub (BL)	01SB04200B
4-9	SK700680	Key Top 2	01SB10-S
4-10x	SK700681	Key Top 2 (BL)	01SB10-B
4-11	TA322179	Pad (R-1)	ATK-2015
4-12x	TA322180	Pad (R-1-BL)	ATK-2015
4-13	TA322176	Pad (L-1)	ATK-2015
4-14x	TA322178	Pad (L-1-BL)	ATK-2015
4-15	SZ700706	Panel Smoke (U/T)	01SB05-U/T
4-16x	SZ700685	Panel Smoke (CEE)	01SB05-CEE
4-17	ZS321782	BID 40 x 08 STL N13	
4-18x	ZS537074	BID 40 x 06 STL BNI (BL)	
4-19x	SA311742	Round Foot	PC-2032
4-20x	ZS609478	PAN 26 x 06 STL BNI	
4-21x	ZS417407	PAN 30 x 10 STL BNI	
4-22x	ZS609208	T2 PAN 30 x 08 STL BNI	
4-23x	SZ323193	FLD Plate	ATV-4037

When ordering parts, please quote Parts Number, Description and Model Number.

INDEX

1. MODEL DT-100

2. MODEL DT-200

Parts No.	Ref. No. & Symbol No.	Parts No.	Ref. No. & Symbol No.	Parts No.	Ref. No. & Symbol No.	Parts No.	Ref. No. & Symbol No.
BT700666	3-3			BT700697	3-3		
EC306477	1-C1			EC306477	1-C10		
EC315346	1-C4			EC315346	1-C8		
EC325671	1-C1			EC325671	1-C10		
ED302379	1-D3T09			ED302379	1-D1T013		
ED700658	1-D10			ED700664	2-D33		
ED700659	1-D11			ED700665	2-D31		
ED700664	2-D13			ED700665	2-D32		
ED700665	2-D14			ED700665	2-D34		
ED700722	1-D1,2			ED700695	1-D21		
ED700723	1-D12			ED700696	1-D22		
EI700655	1-IC2			ED700721	1-D23		
EI700656	1-FLD			ED700722	1-D14,15		
EI700654	1-IC1			ED700723	1-D24		
EI700662	1-X*TAL			EI700655	1-IC2		
EJ296853	3-13x			EI700662	1-X*TAL		
EJ700667	3-4			EI700693	1-IC1		
EJ700668	3-5x			EJ296853	3-17x		
EP700724	3-1			EJ700667	3-4		
EP700725	3-2x			EJ700668	3-5x		
ES700674	3-6			EM700698	1-FLD		
ES700675	3-7			EP700724	3-1		
ES700676	3-9			EP700725	3-2x		
ES700677	3-10			ES700676	3-13		
ES700720	3-8			ES700707	3-14		
ET328569	1-Q1T03			ES700708	3-6		
ET700657	1-Q4			ES700709	3-7x		
ET700663	2-CDS			ES700710	3-10x		
EW374894	3-12			ES700711	3-11x		
EW496855	3-14x			ES700712	3-8		
EZ631945	3-11x			ES700713	3-9x		
SA311742	4-17x			ES700720	3-12		
SK700678	4-5			ET328569	1-Q3T07		
SK700679	4-6x			ET537300	1-Q1		
SK700680	4-7			ET700657	1-Q2		
SK700681	4-8x			ET700663	2-CDS		
SP700669	4-1			EW374894	3-16		
SP700670	4-2x			EW496855	3-18x		
SP700671	4-3			EZ700744	3-15x		
SP700673	4-4x			SA311742	4-19x		
SP700682	4-9			SK700680	4-9		
SP700684	4-10x			SK700681	4-10x		
SZ323193	4-12x			SP700669	4-1		
SZ700685	4-11			SP700670	4-2x		
TA322176	4-13			SP700699	4-5x		
TA322178	4-14x			SP700700	4-6x		
TA322179	4-15			SP700701	4-3		
TA322180	4-16x			SP700702	4-4x		
ZS321782	4-18			SP700703	4-7		
ZS417407	4-21x			SP700704	4-8x		
ZS537074	4-19x			SZ323193	4-23x		
ZS609208	4-22x			SZ700685	4-16x		
ZS609478	4-20x			SZ700706	4-15		
				TA322176	4-13		
				TA322178	4-14x		
				TA322179	4-11		
				TA322180	4-12x		
				ZS321782	4-17		
				ZS417407	4-21x		
				ZS537074	4-18x		
				ZS609208	4-22x		
				ZS609478	4-20x		

SECTION 3

SCHEMATIC DIAGRAM

1. DT-100 NO. 160144A SCHEMATIC DIAGRAM
2. DT-200 NO. 160143A SCHEMATIC DIAGRAM

DT-100

CEE,UK,SA

U/T,CSA,AAL

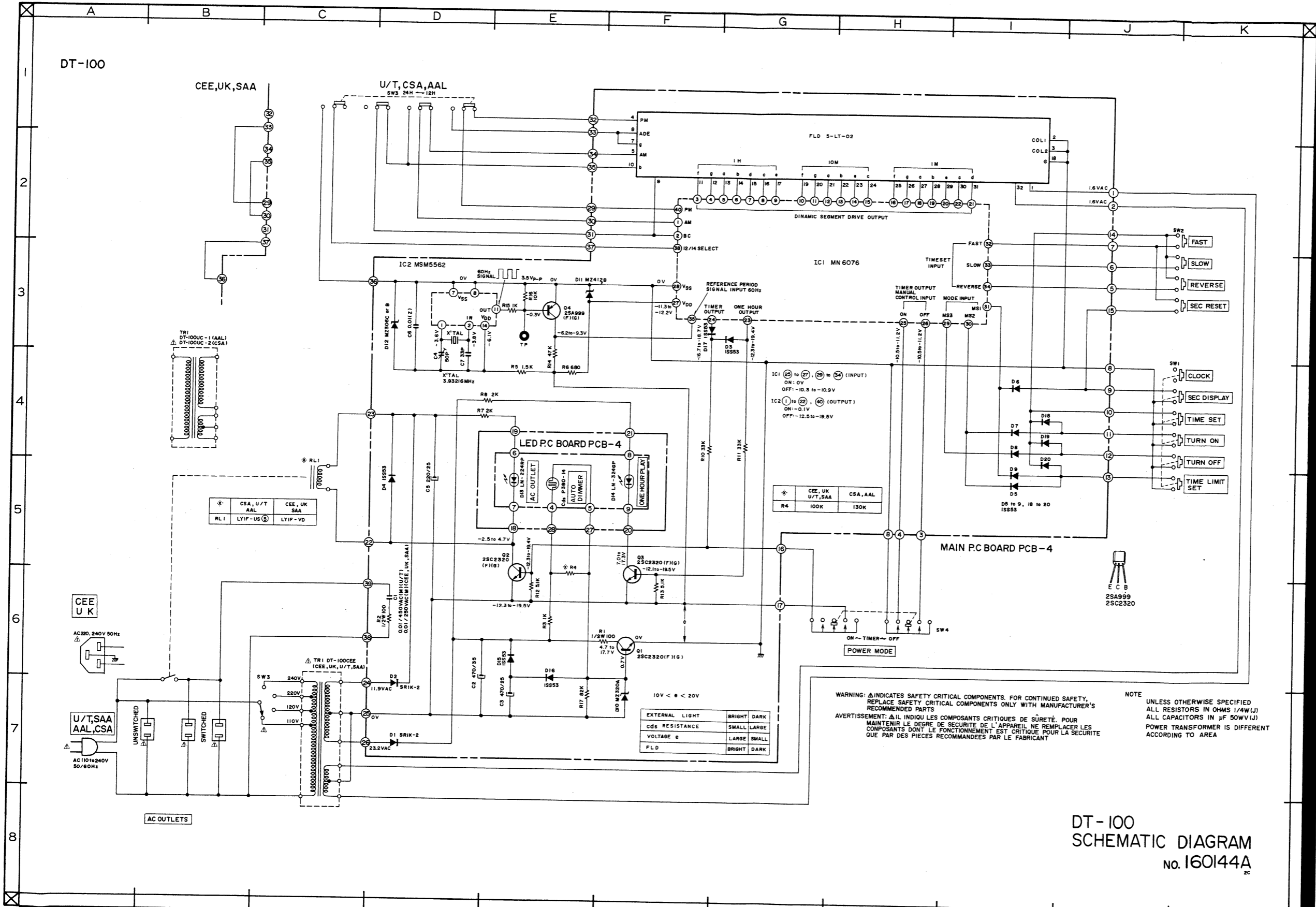

*	CSA, U/T	CEE, UK
	AAL	SAA
RL1	LYIF-US	LYIF-VD

*	CEE, UK	CSA, AAL
	U/T, SAA	
R4	100K	130K

EXTERNAL LIGHT	BRIGHT	DARK
CDS RESISTANCE	SMALL	LARGE
VOLTAGE e	LARGE	SMALL
FLD	BRIGHT	DARK

WARNING: Δ INDICATES SAFETY CRITICAL COMPONENTS. FOR CONTINUED SAFETY, REPLACE SAFETY CRITICAL COMPONENTS ONLY WITH MANUFACTURER'S RECOMMENDED PARTS.
 AVERTISSEMENT: Δ IL INDIQUE LES COMPOSANTS CRITIQUES DE SÛRETÉ. POUR MAINTENIR LE DEGRÉ DE SÛRETÉ DE L'APPAREIL, NE REMPLACER LES COMPOSANTS DONT LE FONCTIONNEMENT EST CRITIQUE QUE PAR DES PIÈCES RECOMMANDÉES PAR LE FABRICANT.

NOTE
 UNLESS OTHERWISE SPECIFIED ALL RESISTORS IN OHMS 1/4W(J) ALL CAPACITORS IN μF 50WV(J) POWER TRANSFORMER IS DIFFERENT ACCORDING TO AREA

DT-100
 SCHEMATIC DIAGRAM
 No. 160144A

DT-200

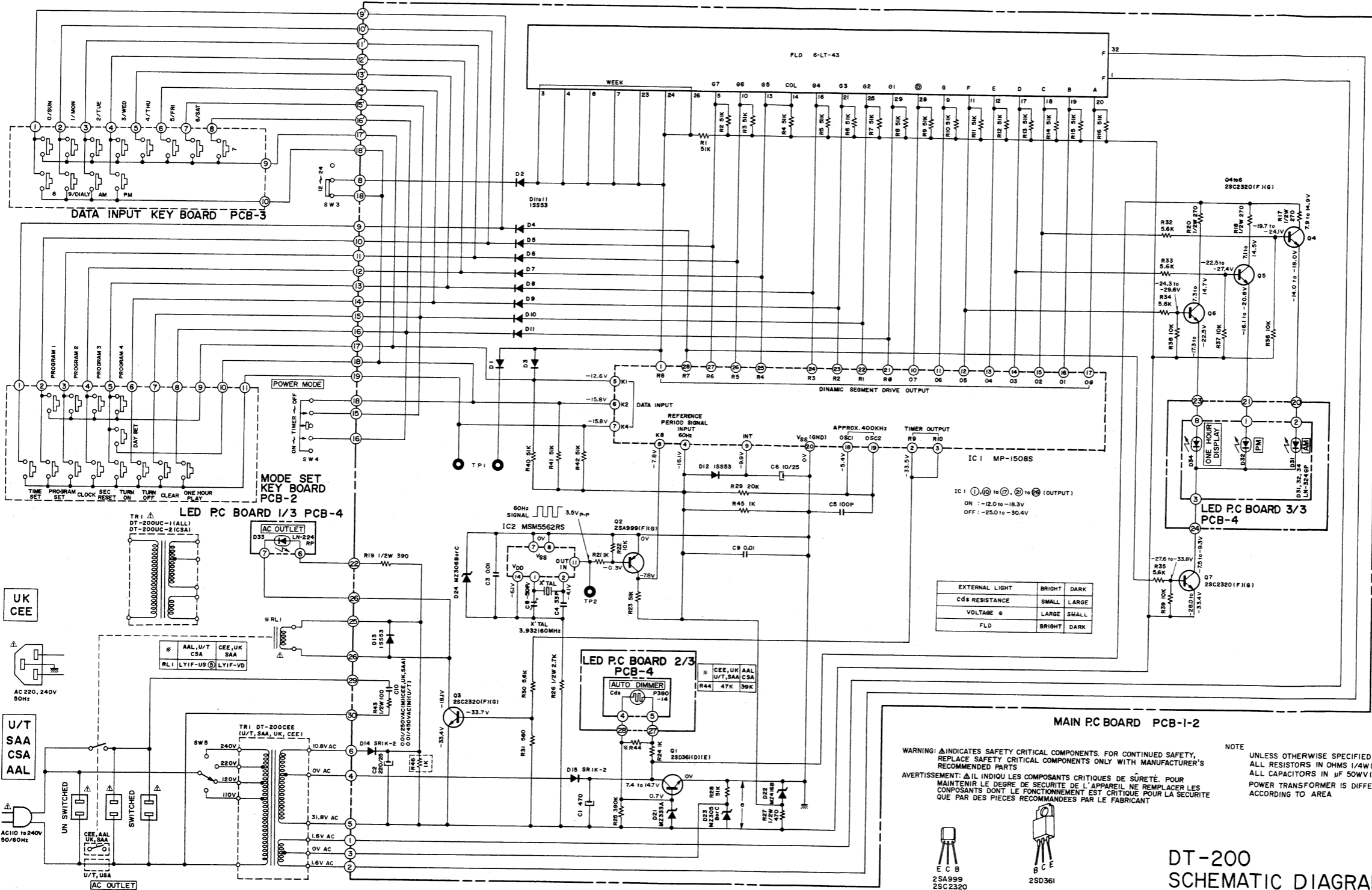

EXTERNAL LIGHT	BRIGHT	DARK
CDS RESISTANCE	SMALL	LARGE
VOLTAGE	LARGE	SMALL
FLD	BRIGHT	DARK

WARNING: Δ INDICATES SAFETY CRITICAL COMPONENTS. FOR CONTINUED SAFETY, REPLACE SAFETY CRITICAL COMPONENTS ONLY WITH MANUFACTURER'S RECOMMENDED PARTS.
 AVERTISSEMENT: Δ IL INDIQUÉ LES COMPOSANTS CRITIQUES DE SÛRETÉ. POUR MAINTENIR LE DEGRÉ DE SÛRETÉ DE L'APPAREIL, NE REMPLACER LES COMPOSANTS DONT LE FONCTIONNEMENT EST CRITIQUE POUR LA SÛRETÉ QUE PAR DES PIÈCES RECOMMANDÉES PAR LE FABRICANT.

NOTE: UNLESS OTHERWISE SPECIFIED, ALL RESISTORS IN OHMS (1/4W/J), ALL CAPACITORS IN μF (50WV/J). POWER TRANSFORMER IS DIFFERENT ACCORDING TO AREA.



DT-200
 SCHEMATIC DIAGRAM
 No. 160143A